

Power MOSFET

PRODUCT SUMMARY		
V_{DS} (V)	500	
$R_{DS(on)}$ (Max.) (Ω)	$V_{GS} = 10$ V	1.40
Q_g (Max.) (nC)	24	
Q_{gs} (nC)	6.3	
Q_{gd} (nC)	11	
Configuration	Single	

FEATURES

- Low Gate Charge Q_g Results in Simple Drive Requirement
- Improved Gate, Avalanche and Dynamic dV/dt Ruggedness
- Fully Characterized Capacitance and Avalanche Voltage and Current
- Effective C_{OSS} specified
- Lead (Pb)-free Available



RoHS*
COMPLIANT

APPLICATIONS

- Switch Mode Power Supply (SMPS)
- Uninterruptible Power Supply
- High speed power switching

TYPICAL SMPS TOPOLOGIES

- Two Transistor Forward
- Half Bridge and Full Bridge

I²PAK
(TO-262)

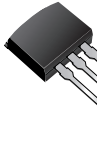

D²PAK
(TO-263)

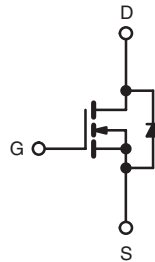
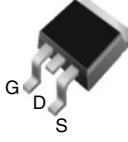

N-Channel MOSFET

ORDERING INFORMATION			
Package	D ² PAK (TO-263)	D ² PAK (TO-263)	I ² PAK (TO-262)
Lead (Pb)-free	IRF830ASPbF	IRF830ASTRLPbF ^a	IRF830ALPbF
	SiHF830AS-E3	SiHF830ASTL-E3 ^a	SiHF830AL-E3
SnPb	IRF830AS	IRF830ASTRL ^a	IRF830AL
	SiHF830AS	SiHF830ASTL ^a	SiHF830AL

Note

a. See device orientation.

ABSOLUTE MAXIMUM RATINGS $T_C = 25$ °C, unless otherwise noted				
PARAMETER	SYMBOL	LIMIT	UNIT	
Drain-Source Voltage	V_{DS}	500	V	
Gate-Source Voltage	V_{GS}	± 30		
Continuous Drain Current	V_{GS} at 10 V	$T_C = 25$ °C	5.0	A
		$T_C = 100$ °C	3.2	
Pulsed Drain Current ^{a, e}	I_{DM}	20		
Linear Derating Factor		0.59	W/°C	
Single Pulse Avalanche Energy ^{b, e}	E_{AS}	230	mJ	
Avalanche Current ^a	I_{AR}	5.0	A	
Repetitive Avalanche Energy ^a	E_{AR}	7.4	mJ	
Maximum Power Dissipation		$T_A = 25$ °C	3.1	W
		$T_C = 25$ °C	74	
Peak Diode Recovery dV/dt ^{c, e}	dV/dt	5.3	V/ns	
Operating Junction and Storage Temperature Range	T_J, T_{stg}	- 55 to + 150	°C	
Soldering Recommendations (Peak Temperature)	for 10 s	300 ^d		

Notes

- Repetitive rating; pulse width limited by maximum junction temperature (see fig. 11).
- Starting $T_J = 25$ °C, $L = 18$ mH, $R_G = 25$ Ω , $I_{AS} = 5.0$ A (see fig. 12).
- $I_{SD} \leq 5.0$ A, $dI/dt \leq 370$ A/ μ s, $V_{DD} \leq V_{DS}$, $T_J \leq 150$ °C.
- 1.6 mm from case.
- Uses SiHF830A data and test conditions.

* Pb containing terminations are not RoHS compliant, exemptions may apply

THERMAL RESISTANCE RATINGS				
PARAMETER	SYMBOL	TYP.	MAX.	UNIT
Maximum Junction-to-Ambient (PCB Mounted, steady-state) ^a	R_{thJA}	-	40	°C/W
Maximum Junction-to-Case (Drain)	R_{thJC}	-	1.7	

Note

a. When mounted on 1" square PCB (FR-4 or G-10 material).

SPECIFICATIONS $T_J = 25\text{ }^\circ\text{C}$, unless otherwise noted							
PARAMETER	SYMBOL	TEST CONDITIONS	MIN.	TYP.	MAX.	UNIT	
Static							
Drain-Source Breakdown Voltage	V_{DS}	$V_{GS} = 0\text{ V}$, $I_D = 250\text{ }\mu\text{A}$	500	-	-	V	
V_{DS} Temperature Coefficient	$\Delta V_{DS}/T_J$	Reference to $25\text{ }^\circ\text{C}$, $I_D = 1\text{ mA}^d$	-	0.60	-	V/°C	
Gate-Source Threshold Voltage	$V_{GS(th)}$	$V_{DS} = V_{GS}$, $I_D = 250\text{ }\mu\text{A}$	2.0	-	4.5	V	
Gate-Source Leakage	I_{GSS}	$V_{GS} = \pm 30\text{ V}$	-	-	± 100	nA	
Zero Gate Voltage Drain Current	I_{DSS}	$V_{DS} = 500\text{ V}$, $V_{GS} = 0\text{ V}$	-	-	25	μA	
		$V_{DS} = 400\text{ V}$, $V_{GS} = 0\text{ V}$, $T_J = 125\text{ }^\circ\text{C}$	-	-	250		
Drain-Source On-State Resistance	$R_{DS(on)}$	$V_{GS} = 10\text{ V}$ $I_D = 3.0\text{ A}^b$	-	-	1.4	Ω	
Forward Transconductance	g_{fs}	$V_{DS} = 50\text{ V}$, $I_D = 3.0\text{ A}^d$	2.8	-	-	S	
Dynamic							
Input Capacitance	C_{iss}	$V_{GS} = 0\text{ V}$, $V_{DS} = 25\text{ V}$, $f = 1.0\text{ MHz}$, see fig. 5 ^d	-	620	-	μF	
Output Capacitance	C_{oss}		-	93	-		
Reverse Transfer Capacitance	C_{rss}		-	4.3	-		
Output Capacitance	C_{oss}	$V_{GS} = 0\text{ V}$	$V_{DS} = 1.0\text{ V}$, $f = 1.0\text{ MHz}$	-	886	-	
Effective Output Capacitance	$C_{oss\text{ eff.}}$		$V_{DS} = 400\text{ V}$, $f = 1.0\text{ MHz}$	-	27	-	
Total Gate Charge	Q_g	$V_{GS} = 10\text{ V}$	$V_{DS} = 0\text{ V to } 400\text{ V}^{c, d}$	-	39	-	
Gate-Source Charge	Q_{gs}		$I_D = 5.0\text{ A}$, $V_{DS} = 400\text{ V}$, see fig. 6 and 13 ^{b, d}	-	-	24	nC
Gate-Drain Charge	Q_{gd}			-	-	6.3	
Turn-On Delay Time	$t_{d(on)}$	$V_{DD} = 250\text{ V}$, $I_D = 5.0\text{ A}$, $R_G = 14\text{ }\Omega$, $R_D = 49\text{ }\Omega$, see fig. 10 ^{b, d}	-	10	-	ns	
Rise Time	t_r		-	21	-		
Turn-Off Delay Time	$t_{d(off)}$		-	21	-		
Fall Time	t_f		-	15	-		
Drain-Source Body Diode Characteristics							
Continuous Source-Drain Diode Current	I_S	MOSFET symbol showing the integral reverse p - n junction diode 	-	-	5.0	A	
Pulsed Diode Forward Current ^a	I_{SM}		-	-	20		
Body Diode Voltage	V_{SD}	$T_J = 25\text{ }^\circ\text{C}$, $I_S = 5.0\text{ A}$, $V_{GS} = 0\text{ V}^b$	-	-	1.5	V	
Body Diode Reverse Recovery Time	t_{rr}	$T_J = 25\text{ }^\circ\text{C}$, $I_F = 5.0\text{ A}$, $dI/dt = 100\text{ A}/\mu\text{s}^{b, d}$	-	430	650	ns	
Body Diode Reverse Recovery Charge	Q_{rr}		-	2.0	3.0	μC	
Forward Turn-On Time	t_{on}	Intrinsic turn-on time is negligible (turn-on is dominated by L_S and L_D)					

Notes

- Repetitive rating; pulse width limited by maximum junction temperature (see fig. 11).
- Pulse width $\leq 300\text{ }\mu\text{s}$; duty cycle $\leq 2\%$.
- $C_{oss\text{ eff.}}$ is a fixed capacitance that gives the same charging time as C_{oss} while V_{DS} is rising from 0 to 80% V_{DS} .
- Uses SiHF830A data and test conditions.



TYPICAL CHARACTERISTICS 25 °C, unless otherwise noted

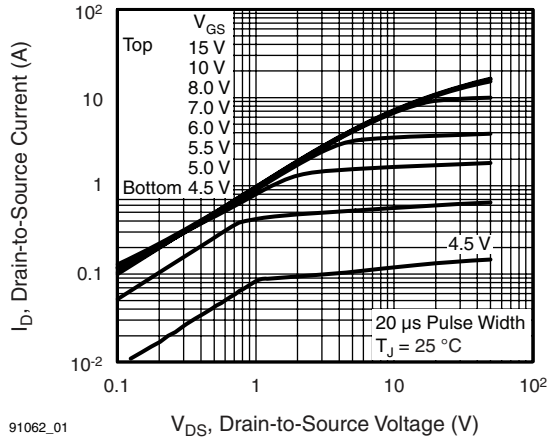

91062_01

Fig. 1 - Typical Output Characteristics

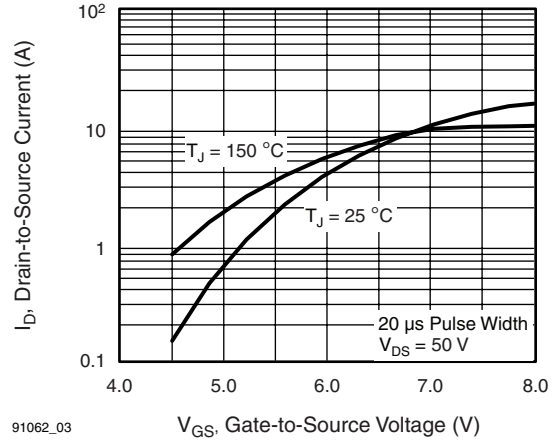

91062_03

Fig. 3 - Typical Transfer Characteristics

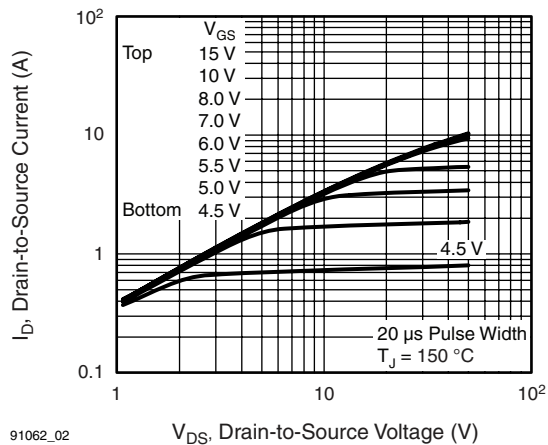

91062_02

Fig. 2 - Typical Output Characteristics

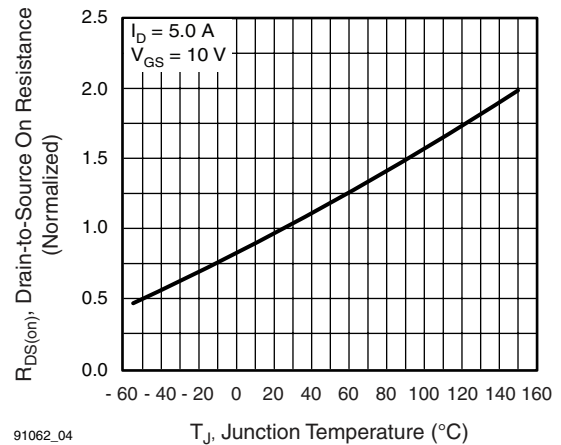

91062_04

Fig. 4 - Normalized On-Resistance vs. Temperature

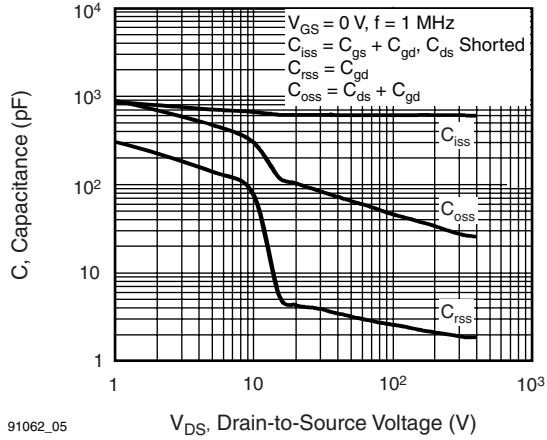

91062_05

Fig. 5 - Typical Capacitance vs. Drain-to-Source Voltage

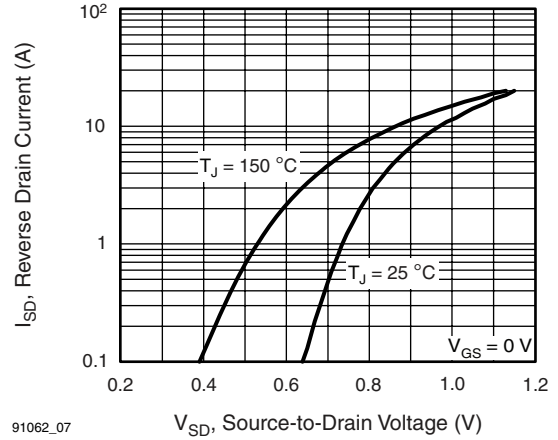

91062_07

Fig. 7 - Typical Source-Drain Diode Forward Voltage

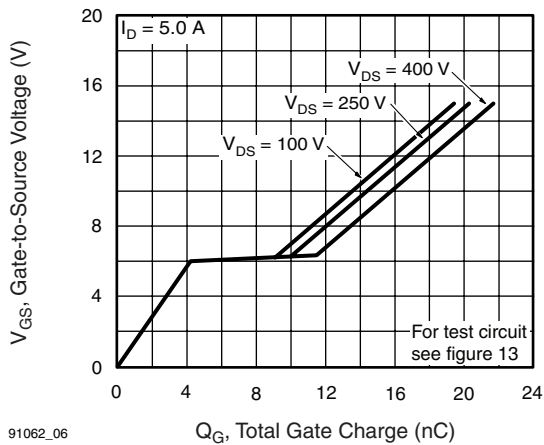

91062_06

Fig. 6 - Typical Gate Charge vs. Gate-to-Source Voltage

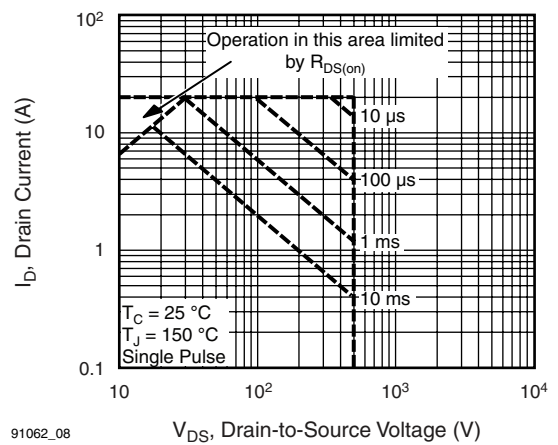

91062_08

Fig. 8 - Maximum Safe Operating Area

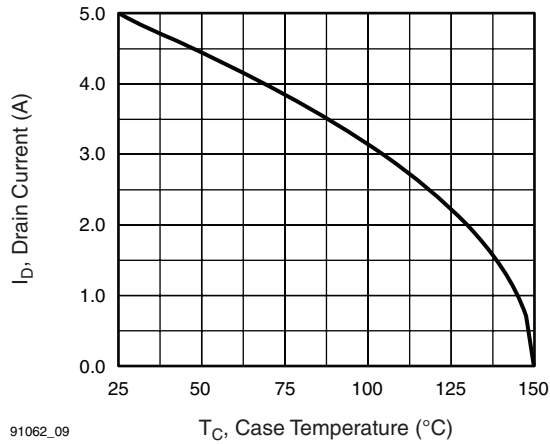

91062_09

Fig. 9 - Maximum Drain Current vs. Case Temperature

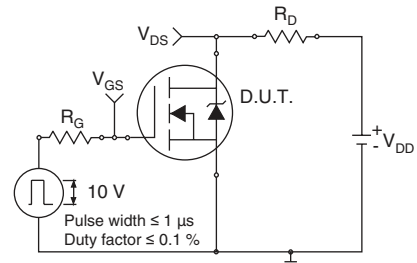

Fig. 10a - Switching Time Test Circuit

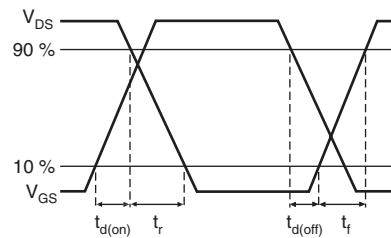
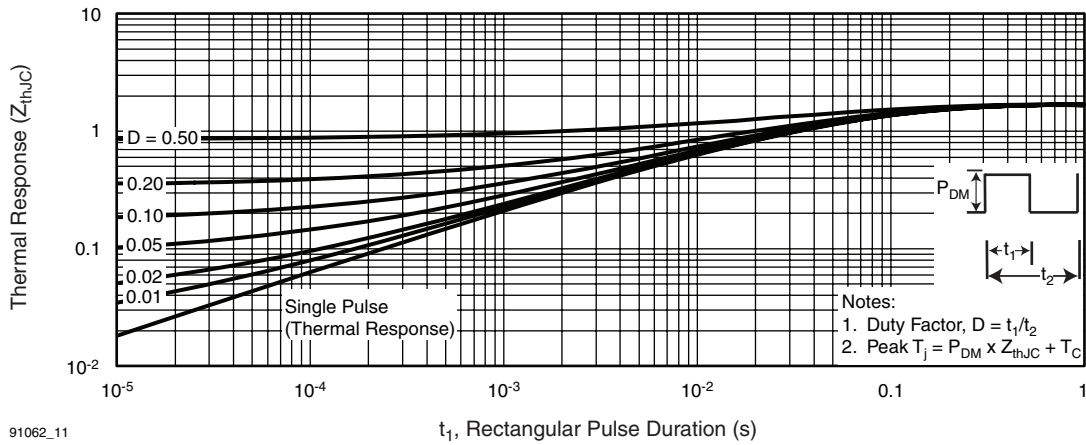

Fig. 10b - Switching Time Waveforms



91062_11

Fig. 11 - Maximum Effective Transient Thermal Impedance, Junction-to-Case

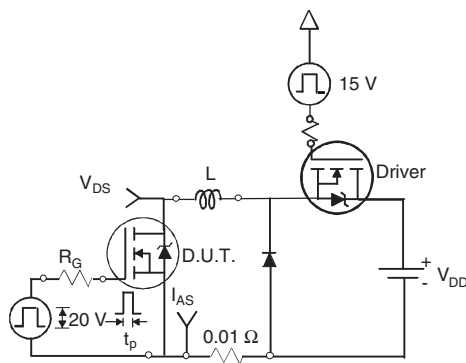

Fig. 12a - Unclamped Inductive Test Circuit

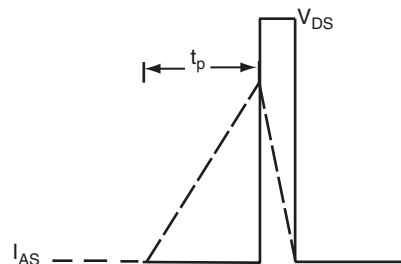
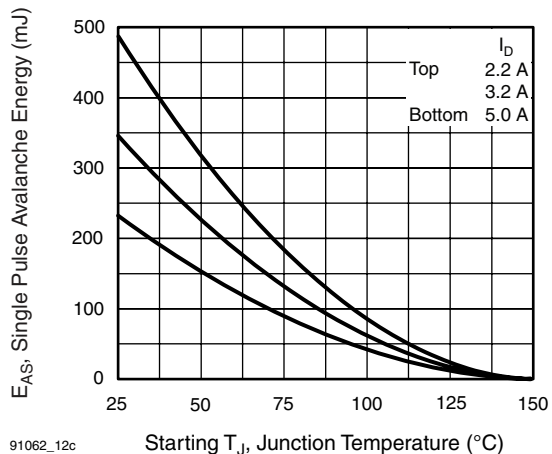
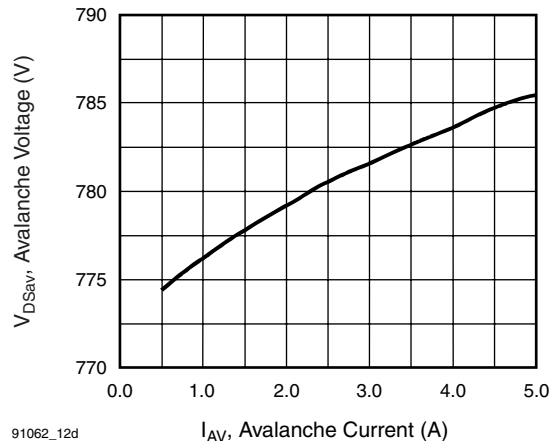

Fig. 12b - Unclamped Inductive Waveforms



91062_12c

Fig. 12c - Maximum Avalanche Energy vs. Drain Current



91062_12d

Fig. 12d - Basic Gate Charge Waveform

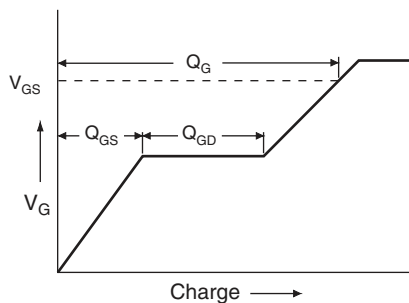

Fig. 13a - Maximum Avalanche Energy vs. Drain Current

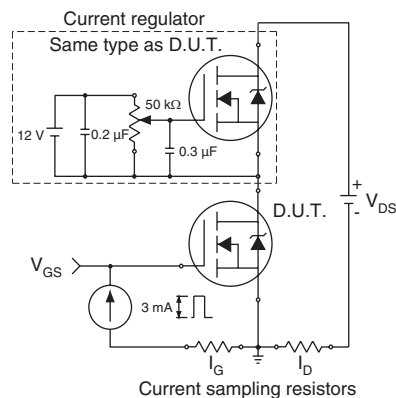

Fig. 13b - Gate Charge Test Circuit

Peak Diode Recovery dV/dt Test Circuit

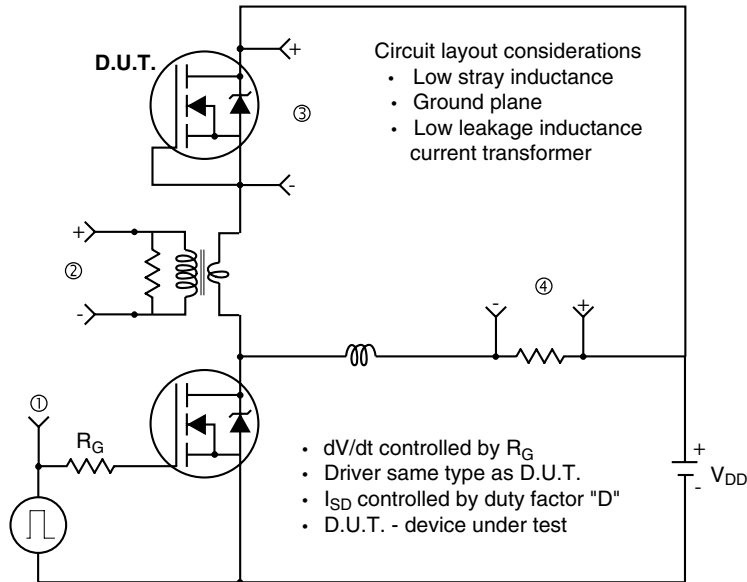

Fig. 14 - For N-Channel

Vishay Siliconix maintains worldwide manufacturing capability. Products may be manufactured at one of several qualified locations. Reliability data for Silicon Technology and Package Reliability represent a composite of all qualified locations. For related documents such as package/tape drawings, part marking, and reliability data, see www.vishay.com/ppg?91062.



Disclaimer

All product specifications and data are subject to change without notice.

Vishay Intertechnology, Inc., its affiliates, agents, and employees, and all persons acting on its or their behalf (collectively, "Vishay"), disclaim any and all liability for any errors, inaccuracies or incompleteness contained herein or in any other disclosure relating to any product.

Vishay disclaims any and all liability arising out of the use or application of any product described herein or of any information provided herein to the maximum extent permitted by law. The product specifications do not expand or otherwise modify Vishay's terms and conditions of purchase, including but not limited to the warranty expressed therein, which apply to these products.

No license, express or implied, by estoppel or otherwise, to any intellectual property rights is granted by this document or by any conduct of Vishay.

The products shown herein are not designed for use in medical, life-saving, or life-sustaining applications unless otherwise expressly indicated. Customers using or selling Vishay products not expressly indicated for use in such applications do so entirely at their own risk and agree to fully indemnify Vishay for any damages arising or resulting from such use or sale. Please contact authorized Vishay personnel to obtain written terms and conditions regarding products designed for such applications.

Product names and markings noted herein may be trademarks of their respective owners.