

- ◆ N-Channel Enhancement Mode
- ◆ Low  $Q_g$  and  $R_g$
- ◆ High  $dv/dt$
- ◆ Nanosecond Switching
- ◆ 30MHz Maximum Frequency

$V_{DSS} = 500 \text{ V}$   
 $I_{D25} = 48 \text{ A}$   
 $R_{DS(on)} \leq 0.13 \Omega$   
 $P_{DC} = 1800 \text{ W}$

| Symbol      | Test Conditions   | Maximum Ratings |      |
|-------------|---|-----------------|------|
| $V_{DSS}$   | $T_J = 25^\circ\text{C}$ to $150^\circ\text{C}$   | 500             | V    |
| $V_{DGR}$   | $T_J = 25^\circ\text{C}$ to $150^\circ\text{C}$ ; $R_{GS} = 1 \text{ M}\Omega$  | 500             | V    |
| $V_{GS}$    | Continuous  | $\pm 20$        | V    |
| $V_{GSM}$   | Transient   | $\pm 30$        | V    |
| $I_{D25}$   | $T_c = 25^\circ\text{C}$  | 48              | A    |
| $I_{DM}$    | $T_c = 25^\circ\text{C}$ , pulse width limited by $T_{JM}$  | 288             | A    |
| $I_{AR}$    | $T_c = 25^\circ\text{C}$  | 44              | A    |
| $E_{AR}$    | $T_c = 25^\circ\text{C}$  | 30              | mJ   |
| $dv/dt$     | $I_S \leq I_{DM}$ , $di/dt \leq 100 \text{ A}/\mu\text{s}$ , $V_{DD} \leq V_{DSS}$ ,<br>$T_J \leq 150^\circ\text{C}$ , $R_G = 0.2 \Omega$ | 5               | V/ns |
|             | $I_S = 0$   | >200            | V/ns |
| $P_{DC}$    |   | 1800            | W    |
| $P_{DHS}$   | $T_c = 25^\circ\text{C}$<br>Derate $4.0 \text{ W}/^\circ\text{C}$ above $25^\circ\text{C}$  | 730             | W    |
| $P_{DAMB}$  | $T_c = 25^\circ\text{C}$  | 4.5             | W    |
| $R_{thJC}$  |   | 0.08            | C/W  |
| $R_{thJHS}$ |   | 0.20            | C/W  |

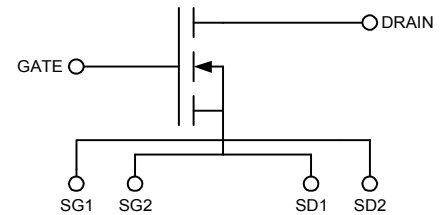

| Symbol        | Test Conditions   | Characteristic Values                               |      |                          |
|---------------|---|---|------|--------------------------|
|               |   | $T_J = 25^\circ\text{C}$ unless otherwise specified |      |                          |
|               |   | min.  | typ. | max.                     |
| $V_{DSS}$     | $V_{GS} = 0 \text{ V}$ , $I_D = 3 \text{ ma}$   | 500   |      | V                        |
| $V_{GS(th)}$  | $V_{DS} = V_{GS}$ , $I_D = 4 \text{ ma}$  | 3.5   | 4.5  | 5.5 V                    |
| $I_{GSS}$     | $V_{GS} = \pm 20 \text{ V}_{DC}$ , $V_{DS} = 0$   |   |      | $\pm 100 \text{ nA}$     |
| $I_{DSS}$     | $V_{DS} = 0.8 V_{DSS}$ , $T_J = 25^\circ\text{C}$<br>$V_{GS} = 0$ , $T_J = 125^\circ\text{C}$                   |   |      | 50 $\mu\text{A}$<br>1 mA |
| $R_{DS(on)}$  | $V_{GS} = 15 \text{ V}$ , $I_D = 0.5 I_{D25}$<br>Pulse test, $t \leq 300 \mu\text{s}$ , duty cycle $d \leq 2\%$ |   |      | 0.13 $\Omega$            |
| $g_{fs}$      | $V_{DS} = 15 \text{ V}$ , $I_D = 0.5 I_{D25}$ , pulse test  |   | 14   | S                        |
| $T_J$         |   | -55   |      | +175 $^\circ\text{C}$    |
| $T_{JM}$      |   |   | 175  | $^\circ\text{C}$         |
| $T_{stg}$     |   | -55   |      | +175 $^\circ\text{C}$    |
| $T_L$         | 1.6mm (0.063 in) from case for 10 s   |   | 300  | $^\circ\text{C}$         |
| <b>Weight</b> |   |   | 3    | g                        |

**Features**

- Isolated Substrate
  - high isolation voltage (>2500V)
  - excellent thermal transfer
  - increased temperature and power cycling capability
- IXYS advanced low  $Q_g$  process
- Low gate charge and capacitances
  - easier to drive
  - faster switching
- Low  $R_{DS(on)}$
- Very low insertion inductance (<2nH)
- No beryllium oxide (BeO) or other hazardous materials

**Advantages**

- Optimized for RF and high speed switching at frequencies to 30MHz
- Easy to mount—no insulators needed
- High power density

| Symbol       | Test Conditions   | Characteristic Values<br>( $T_J = 25^\circ\text{C}$ unless otherwise specified) |      |          |
|--------------|---|---|------|----------|
|              |   | min.  | typ. | max.     |
| $R_G$        |   |   | 0.3  | $\Omega$ |
| $C_{iss}$    |   |   | 5100 | pF       |
| $C_{oss}$    | $V_{GS} = 0\text{ V}$ , $V_{DS} = 0.8 V_{DSS(max)}$ ,<br>$f = 1\text{ MHz}$ |   | 300  | pF       |
| $C_{rss}$    |   |   | 92   | pF       |
| $C_{stray}$  | Back Metal to any Pin   |   | 46   | pF       |
| $T_{d(on)}$  |   |   | 5    | ns       |
| $T_{on}$     | $V_{GS} = 15\text{ V}$ , $V_{DS} = 0.8 V_{DSS}$<br>$I_D = 0.5 I_{DM}$       |   | 5    | ns       |
| $T_{d(off)}$ | $R_G = 0.2\ \Omega$ (External)  |   | 5    | ns       |
| $T_{off}$    |   |   | 8    | ns       |
| $Q_{g(on)}$  |   |   | 155  | nC       |
| $Q_{gs}$     | $V_{GS} = 10\text{ V}$ , $V_{DS} = 0.5 V_{DSS}$<br>$I_D = 0.5 I_{D25}$      |   | 35   | nC       |
| $Q_{gd}$     |   |   | 87   | nC       |

**Source-Drain Diode**
**Characteristic Values**

 ( $T_J = 25^\circ\text{C}$  unless otherwise specified)

| Symbol   | Test Conditions  | min. |     | max.          |
|----------|--|------|-----|---------------|
| $I_S$    | $V_{GS} = 0\text{ V}$  |      |     | 44 A          |
| $I_{SM}$ | Repetitive; pulse width limited by $T_{JM}$  |      |     | 288 A         |
| $V_{SD}$ | $I_F = I_S$ , $V_{GS} = 0\text{ V}$ ,<br>Pulse test, $t \leq 300\ \mu\text{s}$ , duty cycle $\leq 2\%$ |      |     | 1.5 V         |
| $T_{rr}$ |  |      | 200 | ns            |
| $Q_{RM}$ | $I_F = I_S$ , $-di/dt = 100\text{ A}/\mu\text{s}$ ,<br>$V_R = 100\text{ V}$                            |      | 0.6 | $\mu\text{C}$ |
| $I_{RM}$ |  |      | 14  | A             |

CAUTION: Operation at or above the Maximum Ratings values may impact device reliability or cause permanent damage to the device.

Information in this document is believed to be accurate and reliable. IXYSRF reserves the right to make changes to information published in this document at any time and without notice.

For detailed device mounting and installation instructions, see the "Device Installation & Mounting Instructions" technical note on the IXYSRF web site at;

[http://www.ixysrf.com/pdf/switch\\_mode/appnotes/7de\\_series\\_mosfet\\_installation\\_instructions.pdf](http://www.ixysrf.com/pdf/switch_mode/appnotes/7de_series_mosfet_installation_instructions.pdf)

IXYS RF reserves the right to change limits, test conditions and dimensions.

IXYS RF MOSFETS are covered by one or more of the following U.S. patents:

|           |           |           |           |           |           |
|-----------|-----------|-----------|-----------|-----------|-----------|
| 4,835,592 | 4,860,072 | 4,881,106 | 4,891,686 | 4,931,844 | 5,017,508 |
| 5,034,796 | 5,049,961 | 5,063,307 | 5,187,117 | 5,237,481 | 5,486,715 |
| 5,381,025 | 5,640,045 |           |           |           |           |

**Fig. 1**  
**Typical Transfer Characteristics**  
 $V_{DS} = 50V, PW = 15\mu S$

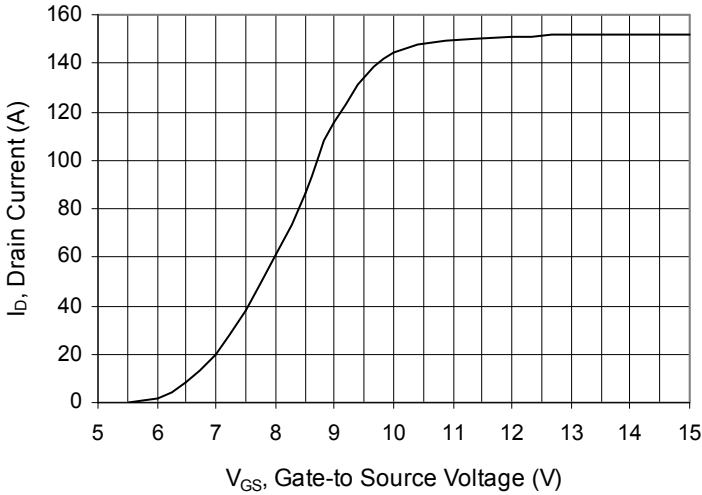

**Fig. 2**  
**Typical Output Characteristics**

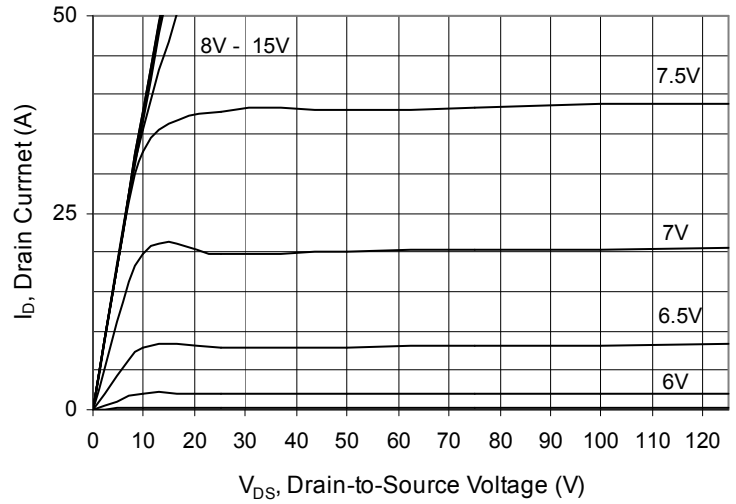

**Fig. 3**  
**Gate Charge vs. Gate-to-Source Voltage**  
 $V_{DS} = 250V, I_D = 22A$

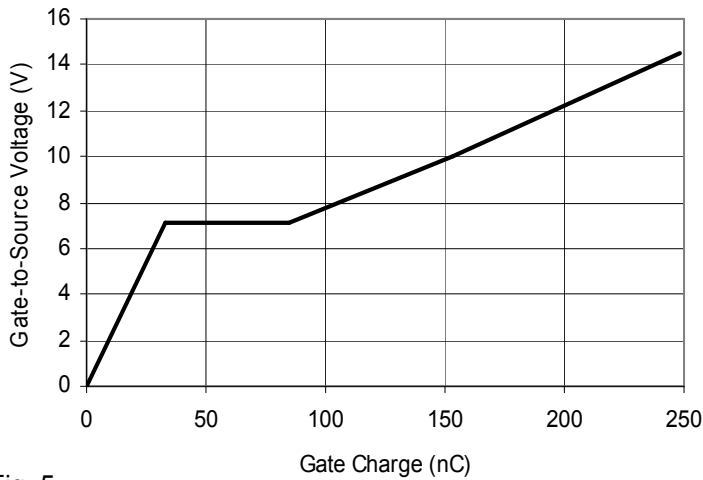

**Fig. 4**  
**Extended Typical Output Characteristics**

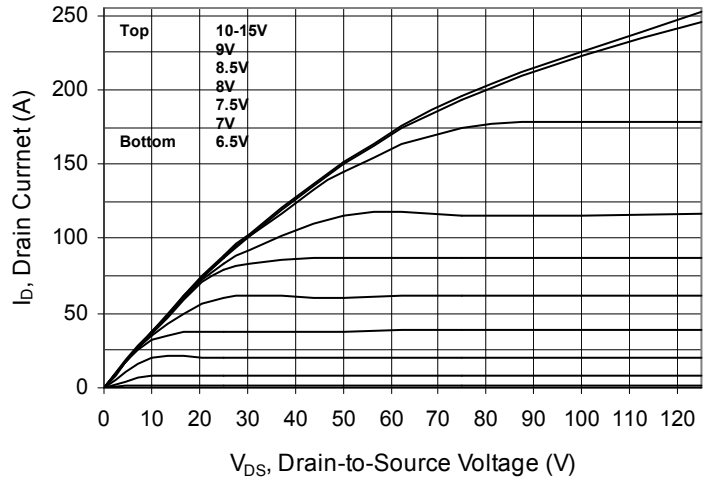

**Fig. 5**  
 **$V_{DS}$  vs. Capacitance**

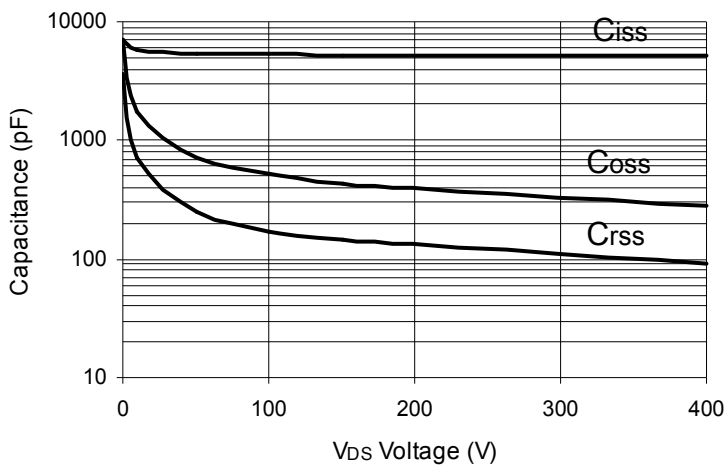
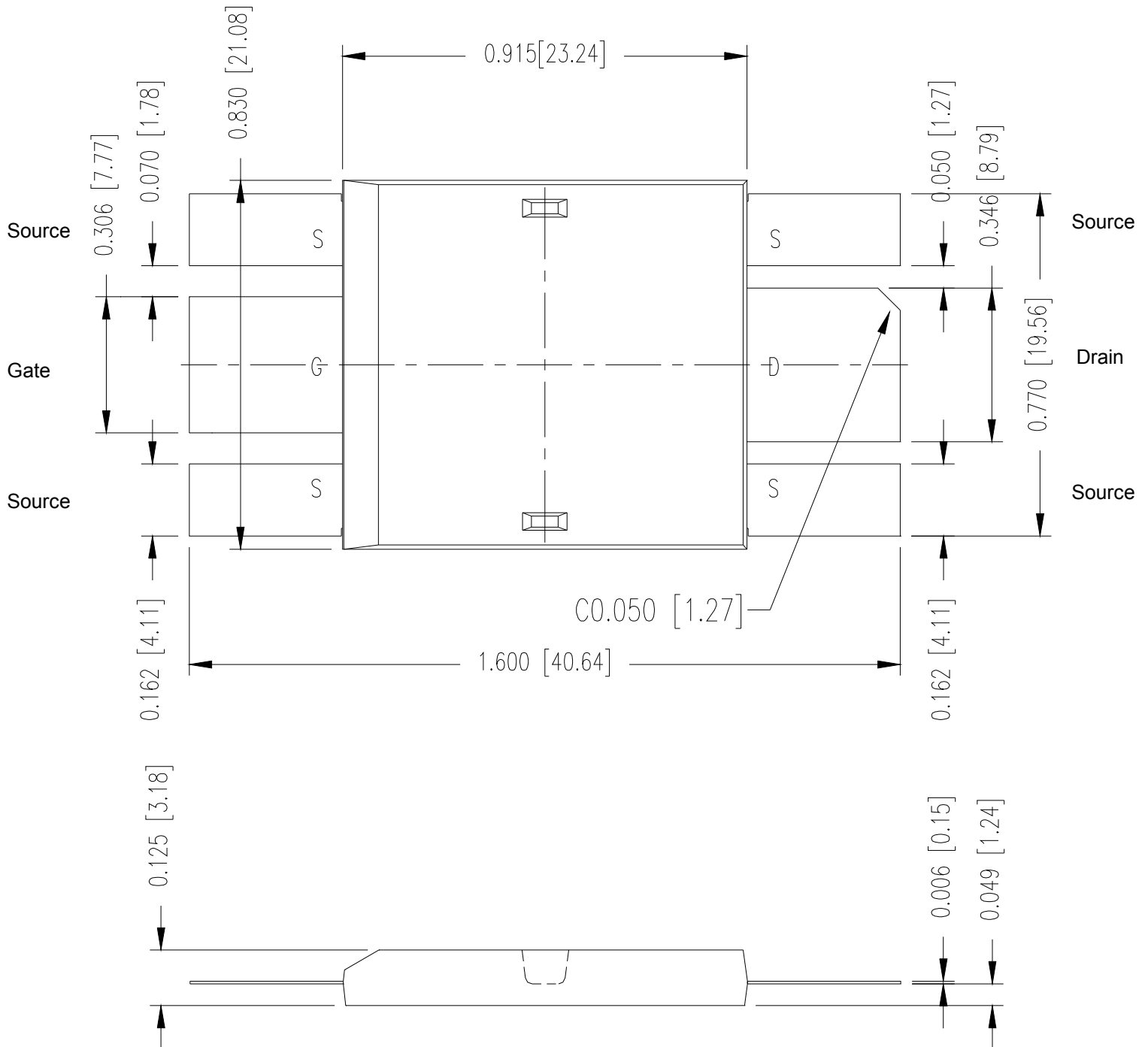

Fig. 6 Package Drawing



**501N44A DE-SERIES SPICE Model (Preliminary)**

The DE-SERIES SPICE Model is illustrated in Figure 7. The model is an expansion of the SPICE level 3 MOSFET model. It includes the stray inductive terms  $L_G$ ,  $L_S$  and  $L_D$ .  $R_d$  is the  $R_{DS(ON)}$  of the device,  $R_{ds}$  is the resistive leakage term. The output capacitance,  $C_{OSS}$ , and reverse transfer capacitance,  $C_{RSS}$  are modeled with reversed biased diodes. This provides a varactor type response necessary for a high power device model. The turn on delay and the turn off delay are adjusted via  $R_{on}$  and  $R_{off}$ .

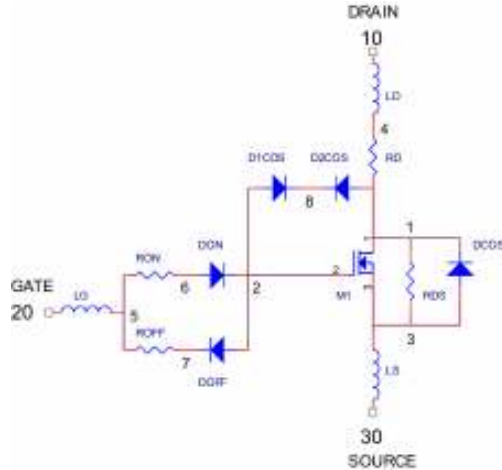

Figure 7 DE-SERIES SPICE Model

This SPICE model may be downloaded as a text file from the IXYSRF web site at

[http://www.ixysrf.com/products/switch\\_mode.html](http://www.ixysrf.com/products/switch_mode.html)

<http://www.ixysrf.com/spice/de475-501n44a.html>

**Net List:**

```
.SUBCKT 501N44A 10 20 30
* TERMINALS: D G S
* 500 Volt 44 Amp 0.13 ohm N-Channel Power MOSFET
* REV.A 01-09-02
M1 1 2 3 3 DMOS L=1U W=1U
RON 5 6 0.3
DON 6 2 D1
ROF 5 7 .1
DOF 2 7 D1
D1CRS 2 8 D2
D2CRS 1 8 D2
CGS 2 3 5.2N
RD 4 1 0.13
DCOS 3 1 D3
RDS 1 3 5.0MEG
LS 3 30 .5N
LD 10 4 1N
LG 20 5 1N
.MODEL DMOS NMOS (LEVEL=3 VTO=3.0 KP=3.8)
.MODEL D1 D (IS=.5F CJO=1P BV=100 M=.5 VJ=.6 TT=1N)
.MODEL D2 D (IS=.5F CJO=400P BV=500 M=.4 VJ=.6 TT=400N RS=10M)
.MODEL D3 D (IS=.5F CJO=900P BV=500 M=.3 VJ=.4 TT=400N RS=10M)
.ENDS
```

Doc #9200-0248 Rev 6  
© 2009 IXYS RF



An IXYS Company  
2401 Research Blvd., Suite 108  
Fort Collins, CO USA 80526  
970-493-1901 Fax: 970-493-1903  
Email: [sales@ixyscolorado.com](mailto:sales@ixyscolorado.com)  
Web: <http://www.ixyscolorado.com>