

DC - 12 GHz Discrete power pHEMT

TGF2021-01

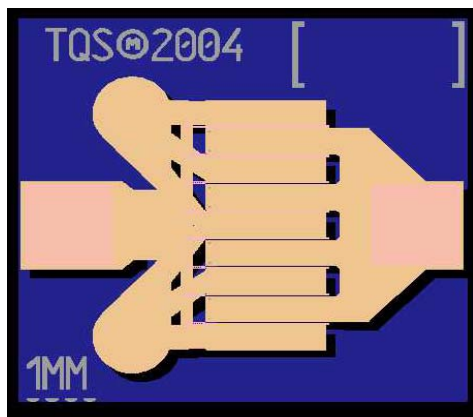

Key Features and Performance

- Frequency Range: DC - 12 GHz
- > 30 dBm Nominal Psat
- 59% Maximum PAE
- 11 dB Nominal Power Gain
- Suitable for high reliability applications
- 1mm x 0.35 μ m Power pHEMT
- Nominal Bias Vd = 8-12V, Idq = 75-125mA (Under RF Drive, Id rises from 75mA to 240mA)
- Chip Dimensions: 0.57 x 0.53 x 0.10 mm (0.022 x 0.021 x 0.004 in)

Product Description

The TriQuint TGF2021-01 is a discrete 1 mm pHEMT which operates from DC-12 GHz. The TGF2021-01 is designed using TriQuint's proven standard 0.35 μ m power pHEMT production process.

The TGF2021-01 typically provides > 30 dBm of saturated output power with power gain of 11 dB. The maximum power added efficiency is 59% which makes the TGF2021-01 appropriate for high efficiency applications.

The TGF2021-01 is also ideally suited for Point-to-point Radio, High-reliability space, and Military applications.

The TGF2021-01 has a protective surface passivation layer providing environmental robustness.

Lead-free and RoHS compliant

Primary Applications

- Point-to-point Radio
- High-reliability space
- Military
- Base Stations
- Broadband Wireless Applications

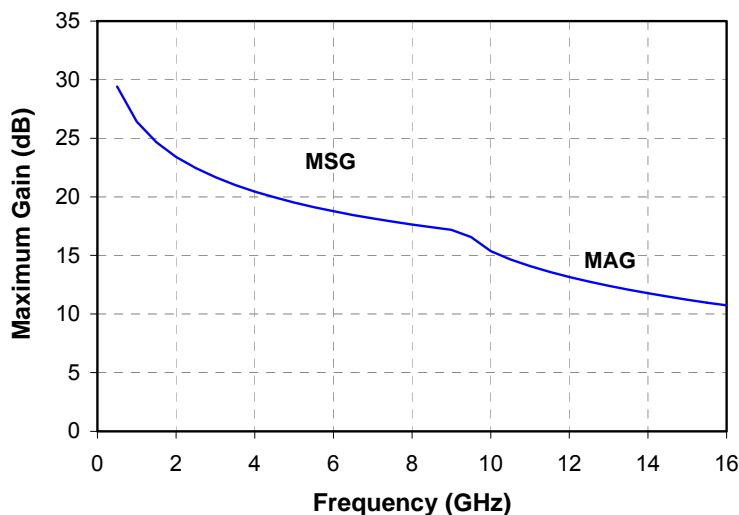

**TABLE I
 MAXIMUM RATINGS**
TGF2021-01

Symbol	Parameter <u>1/</u>	Value	Notes
V ⁺	Positive Supply Voltage	12.5 V	<u>2/</u>
V ⁻	Negative Supply Voltage Range	-5V to 0V	
I ⁺	Positive Supply Current	470 mA	<u>2/</u>
I _G	Gate Supply Current	7 mA	
P _{IN}	Input Continuous Wave Power	25 dBm	<u>2/</u>
P _D	Power Dissipation	See note 3	<u>2/ 3/</u>
T _{CH}	Operating Channel Temperature	150 °C	<u>4/</u>
T _M	Mounting Temperature (30 Seconds)	320 °C	
T _{STG}	Storage Temperature	-65 to 150 °C	

- 1/ These ratings represent the maximum operable values for this device.
- 2/ Combinations of supply voltage, supply current, input power, and output power shall not exceed P_D.
- 3/ For a median life time of 1E+6 hrs, Power dissipation is limited to:
 $P_D(\text{max}) = (150\text{ °C} - T_{\text{BASE}}\text{ °C}) / 86.5\text{ (°C/W)}$
- 4/ Junction operating temperature will directly affect the device median time to failure (T_M). For maximum life, it is recommended that junction temperatures be maintained at the lowest possible levels.

**TABLE II
 DC PROBE CHARACTERISTICS
 (T_A = 25 °C, Nominal)**

Symbol	Parameter	Minimum	Typical	Maximum	Unit
I _{DSS}	Saturated Drain Current	-	300	-	mA
G _m	Transconductance	-	375	-	mS
V _P	Pinch-off Voltage	-1.35	-1	-0.65	V
V _{BGS}	Breakdown Voltage Gate-Source	-30	-	-8	V
V _{BGD}	Breakdown Voltage Gate-Drain	-30	-	-15	V

Note: For TriQuint's 0.35um power pHEMT devices, RF breakdown >> DC breakdown

TABLE III
RF CHARACTERIZATION TABLE 1/
 (T_A = 25 °C, Nominal)

SYMBOL	PARAMETER	Vd = 10V Idq = 75mA	Vd = 12V Idq = 75mA	UNITS
Power Tuned:				
Psat	Saturated Output Power	30.8	31.5	dBm
PAE	Power Added Efficiency	50	48	%
Gain	Power Gain	11	11	dB
Γ_L <u>2/</u>	Load Reflection coefficient	0.541 \angle 147.9	0.546 \angle 140.6	-
Efficiency Tuned:				
Psat	Saturated Output Power	30	30.7	dBm
PAE	Power Added Efficiency	59	55	%
Gain	Power Gain	11.5	11	dB
Γ_L <u>2/</u>	Load Reflection coefficient	0.643 \angle 130.3	0.640 \angle 125.9	-

1/ Values in this table are taken from a 1mm unit pHEMT cell at 10 GHz

2/ Optimum load impedance for maximum power or maximum PAE at 10 GHz.

TABLE IV
THERMAL INFORMATION

Parameter	Test Conditions	T _{CH} (°C)	θ _{JC} (°C/W)	T _M (HRS)
θ _{JC} Thermal Resistance (channel to backside of carrier)	V _d = 12 V I _{dq} = 75 mA P _{diss} = 0.9 W	148	86.5	1.2 E+6

Note: Assumes eutectic attach using 1.5 mil 80/20 AuSn mounted to a 20 mil CuMo Carrier at 70°C baseplate temperature.

Measured Fixtured Data

IMD3 vs. output power/tone at 10 GHz

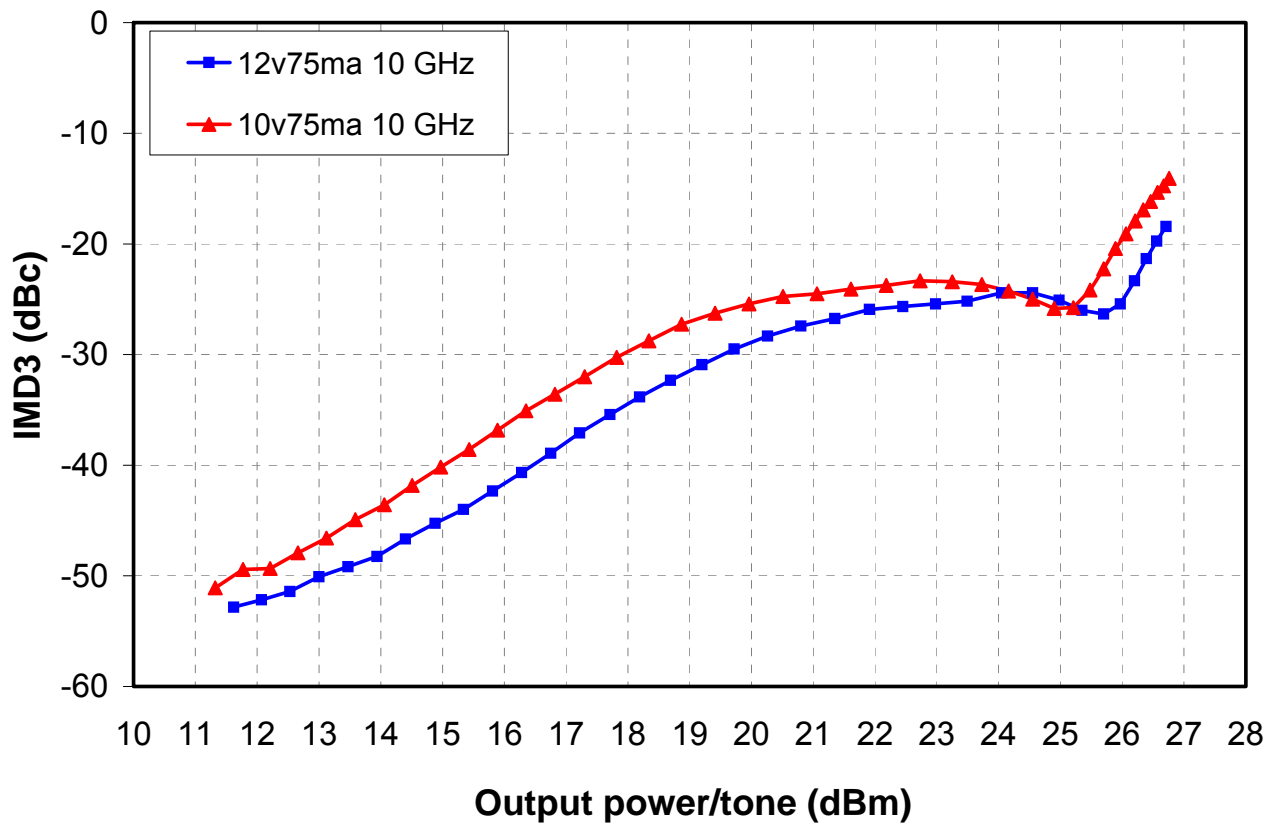

Measured Fixtured Data

Power tuned data at 10GHz

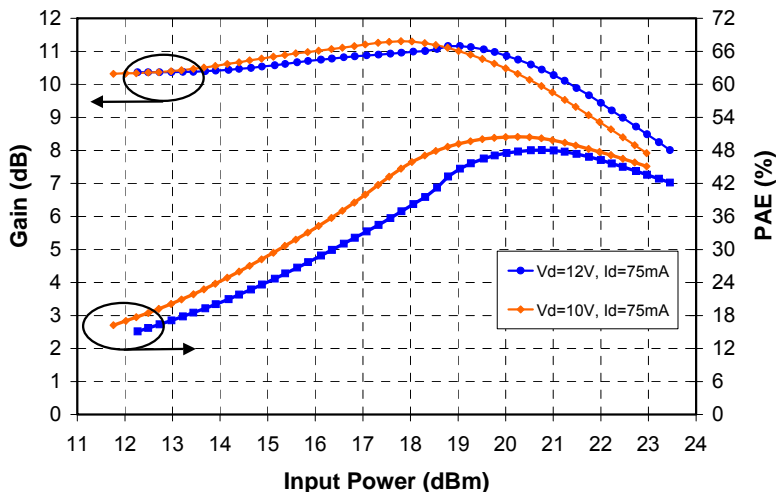
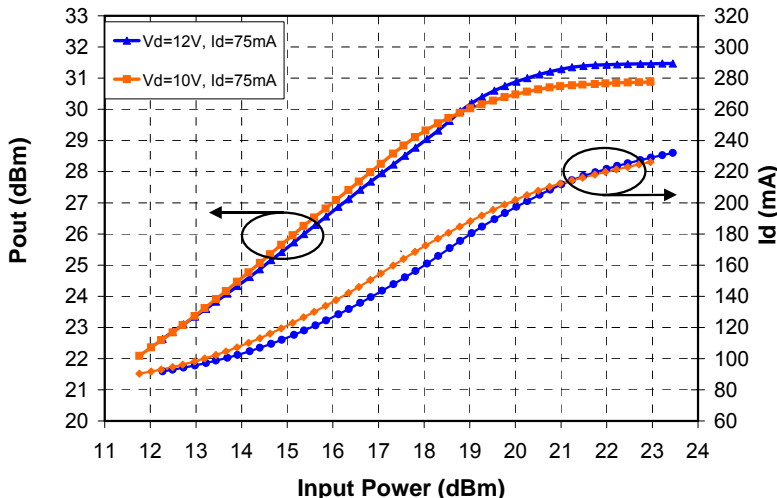

For power tuned devices at 10GHz
 Input matched for maximum gain & output load is:
 Vd=12V, Idq=75mA: $\Gamma_L = 0.546, \theta = 141^\circ$
 Vd=10V, Idq=75mA: $\Gamma_L = 0.541, \theta = 148^\circ$

Efficiency tuned data at 10GHz

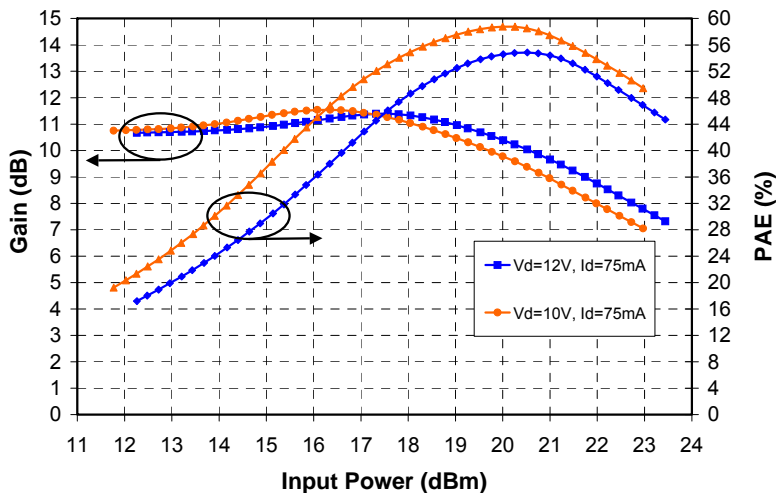
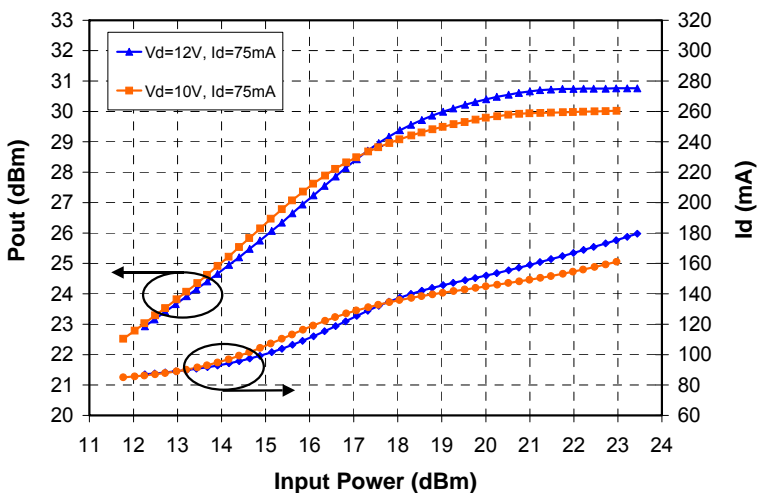

For efficiency tuned devices at 10GHz:
 Input matched for maximum gain & output load is:
 Vd=12V, Idq=75mA: $\Gamma_L = 0.640, \theta = 126^\circ$
 Vd=10V, Idq=75mA: $\Gamma_L = 0.643, \theta = 130^\circ$

Linear Model for 1mm Unit pHEMT cell

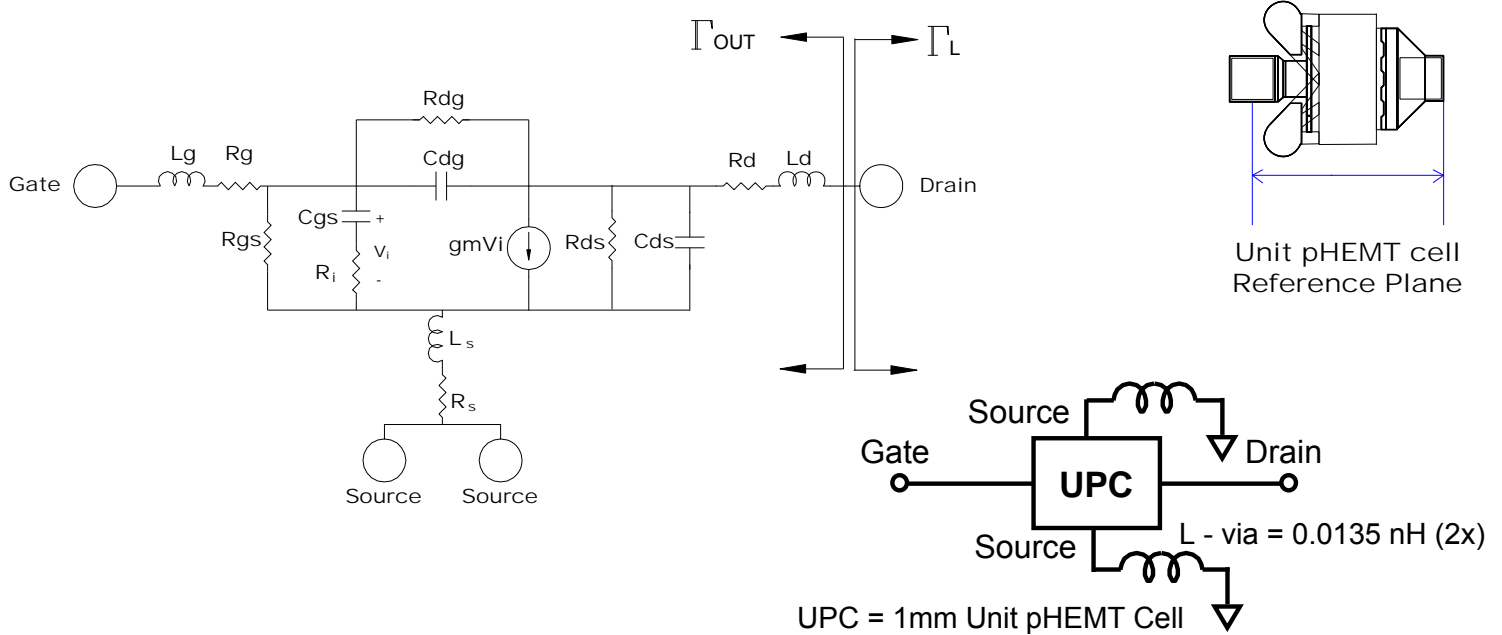

MODEL PARAMETER	Vd = 8V Idq = 75mA	Vd = 8V Idq = 100mA	Vd = 8V Idq = 125mA	Vd = 10V Idq = 75mA	Vd = 10V Idq = 100mA	Vd = 12V Idq = 75mA	UNITS
Rg	0.45	0.45	0.45	0.45	0.450	0.45	Ω
Rs	0.14	0.14	0.14	0.17	0.160	0.19	Ω
Rd	0.41	0.43	0.46	0.41	0.450	0.410	Ω
gm	0.310	0.318	0.314	0.296	0.303	0.286	S
Cgs	2.39	2.58	2.70	2.61	2.74	2.72	pF
Ri	1.22	1.19	1.20	1.24	1.23	1.27	Ω
Cds	0.20	0.201	0.201	0.198	0.199	0.196	pF
Rds	149.1	152.3	158.8	171.8	173.7	187.9	Ω
Cgd	0.115	0.107	0.101	0.101	0.098	0.096	pF
Tau	6.29	6.63	6.99	7.19	7.410	7.79	pS
Ls	0.009	0.009	0.009	0.009	0.010	0.010	nH
Lg	0.089	0.089	0.089	0.089	0.089	0.089	nH
Ld	0.120	0.120	0.120	0.120	0.120	0.120	nH
Rgs	33000	33000	35100	28900	35700	24400	Ω
Rgd	349000	425000	405000	305000	366000	238000	Ω

Unmatched S-parameters for 1 mm pHEMT
Bias Conditions: Vd = 12V, Idq = 75mA

Frequency (GHz)	s11 dB	s11 ang deg	s21 dB	s21 ang deg	s12 dB	s12 ang deg	s22 dB	s22 ang deg
0.5	-0.270	-61.01	25.258	145.86	-33.563	57.93	-5.656	-27.36
1	-0.569	-99.70	22.646	124.02	-30.161	38.19	-7.703	-43.13
1.5	-0.733	-121.84	20.206	110.84	-29.091	27.10	-9.305	-51.41
2	-0.817	-135.39	18.158	101.98	-28.656	20.33	-10.338	-56.61
2.5	-0.862	-144.39	16.443	95.34	-28.452	15.79	-10.943	-60.67
3	-0.889	-150.81	14.983	89.97	-28.353	12.52	-11.253	-64.34
3.5	-0.904	-155.63	13.718	85.36	-28.308	10.03	-11.362	-67.88
4	-0.914	-159.42	12.603	81.26	-28.295	8.05	-11.336	-71.37
4.5	-0.921	-162.50	11.609	77.50	-28.303	6.43	-11.218	-74.81
5	-0.924	-165.08	10.711	73.99	-28.326	5.07	-11.036	-78.20
5.5	-0.926	-167.27	9.894	70.66	-28.360	3.91	-10.811	-81.53
6	-0.927	-169.19	9.142	67.48	-28.403	2.90	-10.558	-84.79
6.5	-0.927	-170.88	8.447	64.40	-28.455	2.03	-10.287	-87.98
7	-0.926	-172.41	7.801	61.42	-28.512	1.26	-10.005	-91.08
7.5	-0.924	-173.79	7.196	58.51	-28.576	0.59	-9.718	-94.10
8	-0.922	-175.06	6.627	55.67	-28.644	0.01	-9.430	-97.04
8.5	-0.920	-176.24	6.090	52.87	-28.717	-0.50	-9.143	-99.90
9	-0.917	-177.33	5.582	50.13	-28.794	-0.94	-8.859	-102.69
9.5	-0.914	-178.37	5.099	47.42	-28.874	-1.31	-8.579	-105.42
10	-0.911	-179.34	4.639	44.75	-28.958	-1.61	-8.306	-108.07
10.5	-0.907	179.73	4.198	42.12	-29.044	-1.85	-8.039	-110.67
11	-0.903	178.84	3.777	39.51	-29.133	-2.03	-7.779	-113.20
11.5	-0.899	177.99	3.372	36.93	-29.223	-2.15	-7.526	-115.68
12	-0.895	177.17	2.982	34.38	-29.315	-2.20	-7.280	-118.11
12.5	-0.891	176.37	2.606	31.85	-29.407	-2.21	-7.042	-120.49
13	-0.886	175.61	2.242	29.35	-29.500	-2.15	-6.811	-122.83
13.5	-0.882	174.86	1.890	26.87	-29.592	-2.03	-6.587	-125.12
14	-0.877	174.13	1.549	24.41	-29.684	-1.86	-6.371	-127.37
14.5	-0.872	173.42	1.218	21.97	-29.774	-1.63	-6.161	-129.57
15	-0.867	172.72	0.896	19.55	-29.863	-1.35	-5.959	-131.75
15.5	-0.862	172.04	0.582	17.14	-29.949	-1.01	-5.762	-133.88
16	-0.857	171.37	0.276	14.76	-30.031	-0.62	-5.573	-135.98
16.5	-0.852	170.72	-0.022	12.39	-30.111	-0.18	-5.389	-138.05
17	-0.847	170.07	-0.314	10.04	-30.185	0.31	-5.212	-140.09
17.5	-0.842	169.43	-0.600	7.70	-30.256	0.85	-5.040	-142.09
18	-0.837	168.80	-0.880	5.38	-30.320	1.43	-4.874	-144.07
18.5	-0.832	168.18	-1.155	3.08	-30.379	2.06	-4.713	-146.02
19	-0.827	167.57	-1.424	0.79	-30.431	2.72	-4.557	-147.94
19.5	-0.821	166.96	-1.689	-1.49	-30.476	3.42	-4.407	-149.83
20	-0.816	166.36	-1.950	-3.75	-30.515	4.14	-4.261	-151.70
20.5	-0.811	165.77	-2.206	-5.99	-30.545	4.89	-4.120	-153.55
21	-0.806	165.18	-2.459	-8.23	-30.568	5.67	-3.984	-155.37
21.5	-0.801	164.60	-2.709	-10.45	-30.582	6.46	-3.852	-157.16
22	-0.796	164.02	-2.955	-12.65	-30.588	7.26	-3.724	-158.94
22.5	-0.791	163.44	-3.198	-14.85	-30.586	8.07	-3.600	-160.69
23	-0.786	162.87	-3.439	-17.03	-30.576	8.89	-3.479	-162.42
23.5	-0.781	162.31	-3.677	-19.21	-30.557	9.70	-3.363	-164.12
24	-0.776	161.75	-3.913	-21.37	-30.530	10.51	-3.250	-165.81
24.5	-0.771	161.19	-4.147	-23.52	-30.495	11.30	-3.141	-167.48
25	-0.766	160.63	-4.379	-25.66	-30.453	12.09	-3.035	-169.13
25.5	-0.761	160.08	-4.609	-27.79	-30.404	12.85	-2.932	-170.75
26	-0.756	159.53	-4.837	-29.91	-30.347	13.59	-2.833	-172.36

Mechanical Drawing

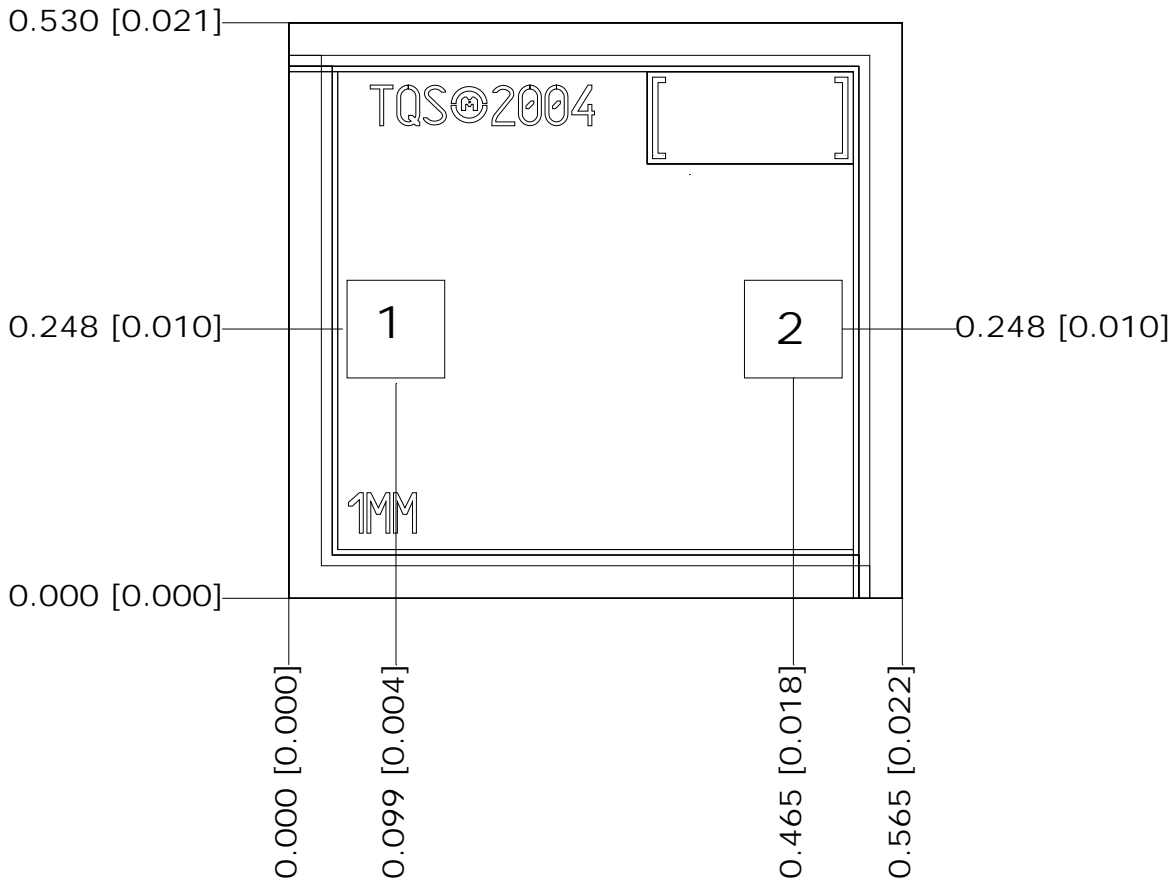

Units: millimeters (inches)

Thickness: 0.100 (0.004)

Chip edge to bond pad dimensions are shown to center of bond pad

Chip size tolerance: +/- 0.051 (0.002)

GND IS BACKSIDE OF MMIC

Bond pad #1 (Vg) 0.090 x 0.090 (0.004 x 0.004)

Bond pad #2 (Vd) 0.090 x 0.090 (0.004 x 0.004)

GaAs MMIC devices are susceptible to damage from Electrostatic Discharge. Proper precautions should be observed during handling, assembly and test.

Assembly Process Notes

Reflow process assembly notes:

- Use AuSn (80/20) solder with limited exposure to temperatures at or above 300 °C for 30 sec
- An alloy station or conveyor furnace with reducing atmosphere should be used.
- Do not use flux
- Coefficient of thermal expansion matching is critical for long-term reliability.
- Devices must be stored in a dry nitrogen atmosphere.

Component placement and adhesive attachment assembly notes:

- Vacuum pencils and/or vacuum collets are the preferred method of pick up.
- Air bridges must be avoided during placement.
- The force impact is critical during auto placement.
- Organic attachment can be used in low-power applications.
- Curing should be done in a convection oven; proper exhaust is a safety concern.
- Microwave or radiant curing should not be used because of differential heating.
- Coefficient of thermal expansion matching is critical.

Interconnect process assembly notes:

- Thermosonic ball bonding is the preferred interconnect technique.
- Force, time, and ultrasonics are critical parameters.
- Aluminum wire should not be used.
- Devices with small pad sizes should be bonded with 0.0007-inch wire.
- Maximum stage temperature is 200 °C.