

## Features

- Bidirectional TVS
- Low capacitance - 12 pF
- ESD protection >15 kV
- Fits 0402 footprint

## Applications

- Computers and peripherals
- Communication systems
- Audio & video equipment
- Portable instrumentation

# CDDFN2-TxxC Series - Surface Mount TVS Diode

## General Information

The CDDFN2-TxxC Series provides ESD and EFT protection for external ports of electronic devices such as cellular phones, hand held electronics and other portable electronic devices.

The device measures 1.05 mm x 0.65 mm and is available in a DFN-2 package and is intended to be mounted directly onto an FR4 printed circuit board. The device will fit an 0402 footprint.

The device is designed to meet IEC 61000-4-2(ESD) and IEC 61000-4-4(EFT) protection requirements.



## Absolute Maximum Ratings (@ T<sub>A</sub> = 25 °C Unless Otherwise Noted)

Parameter	Symbol	CDDFN2-			Unit
		5.0C	12C	24C	
Peak Pulse Power @ 8/20 μs	P <sub>pk</sub>	75	25	47	W
Peak Pulse Current @ 8/20 μs	I <sub>pp</sub>	5	1	1	A
Operating Temperature	T <sub>OPR</sub>	-40 to +125			°C
Storage Temperature	T <sub>STG</sub>	-55 to +150			°C

## Electrical Characteristics (@ T<sub>A</sub> = 25 °C Unless Otherwise Noted)

Parameter	Symbol	CDDFN2-			Unit
		5.0C	12C	24C	
Maximum Working Peak Voltage	V <sub>wm</sub>	5.0	12	24	V
Minimum Breakdown Voltage @ 1 mA	V <sub>BR</sub>	6.0	13	25	V
Maximum Leakage Current @ V <sub>wm</sub>	I <sub>L</sub>	2.0			μA
Typical Capacitance @ 0 V 1 MHz	C <sub>J</sub>	15	12	10	pF
Maximum Capacitance @ 0 V 1 MHz	C <sub>J</sub>	20			pF
Maximum Clamping Voltage @ I <sub>pp</sub> 8/20 μs	V <sub>C</sub>	15	25	47	V
ESD Protection per IEC 61000-4-2					
Minimum Contact Discharge	ESD	8			kV
Minimum Air Discharge	ESD	15			kV

# BOURNS®

**Asia-Pacific:** Tel: +886-2 2562-4117 • Fax: +886-2 2562-4116

**Europe:** Tel: +41-41 768 5555 • Fax: +41-41 768 5510

**The Americas:** Tel: +1-951 781-5500 • Fax: +1-951 781-5700

[www.bourns.com](http://www.bourns.com)

\*RoHS Directive 2002/95/EC Jan 27, 2003 including Annex.

Specifications are subject to change without notice.

Customers should verify actual device performance in their specific applications.

# CDDFN2-TxxC Series - Surface Mount TVS Diode



## Product Dimensions

This is a Molded DFN-2 package with lead free 100 % Au plating on the terminations. It weighs approximately 10 mg.

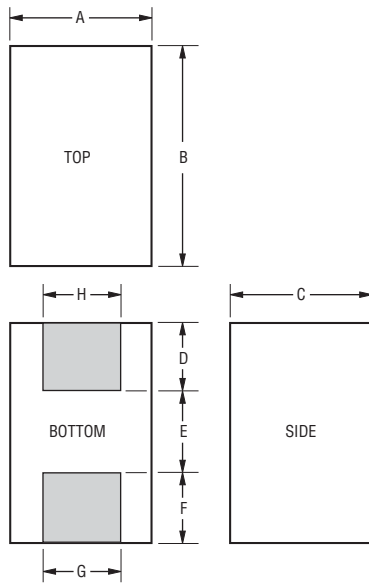

Dimensions	
A	$\frac{0.55-0.65}{(0.022-0.026)}$
B	$\frac{0.95-1.05}{(0.037-.041)}$
C	$\frac{0.45-0.55}{(0.018-.022)}$
D	$\frac{0.30}{(0.012)}$ TYP.
E	$\frac{0.43}{(0.017)}$ TYP.
F	$\frac{0.30}{(0.012)}$ TYP.
G	$\frac{0.50}{(0.020)}$ TYP.
H	$\frac{0.50}{(0.020)}$ TYP.

DIMENSIONS:  $\frac{\text{MM}}{(\text{INCHES})}$

## Recommended PCB Footprint

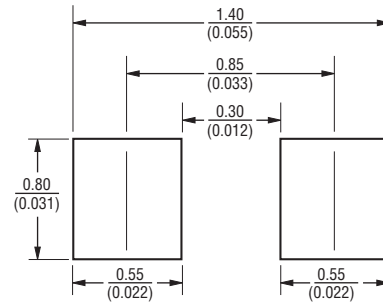

## Typical Part Marking

CDDFN2-T5.0C .....	E5
CDDFN2-T12C .....	E2
CDDFN2-T24C .....	E4

## How to Order

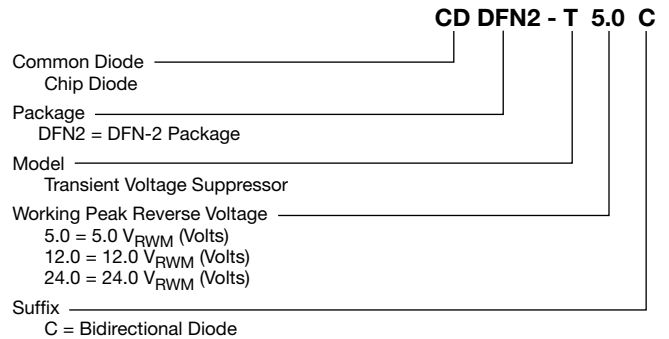

## Block Diagram

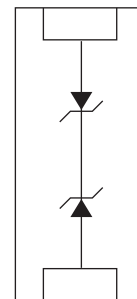

Specifications are subject to change without notice. Customers should verify actual device performance in their specific applications.

# CDDFN2-TxxC Series - Surface Mount TVS Diode

**BOURNS®**

## Rating & Characteristic Curves

### Pulse Waveform

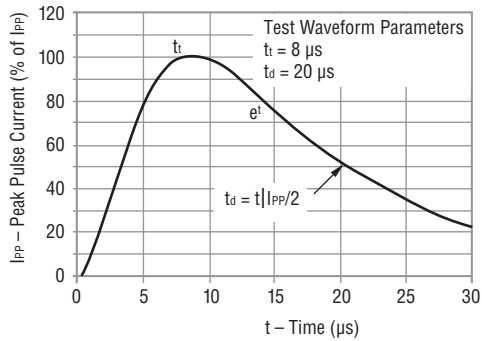

### Reverse Characteristics

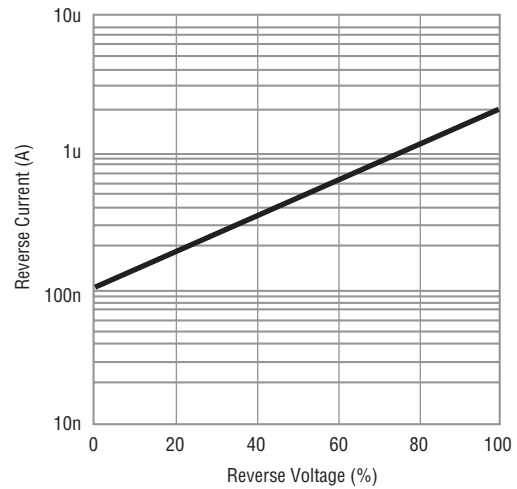

### Power Derating Curve

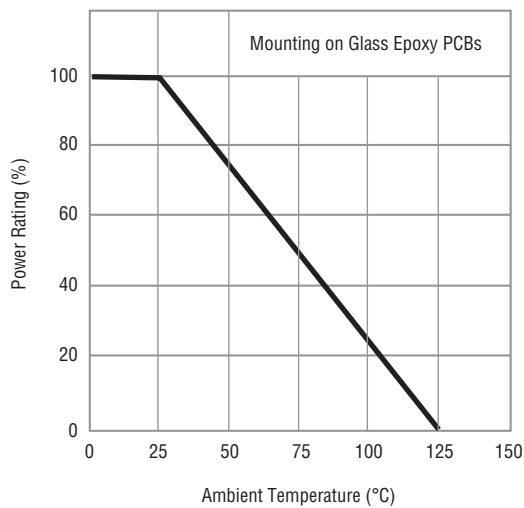

### Capacitance Between Terminals

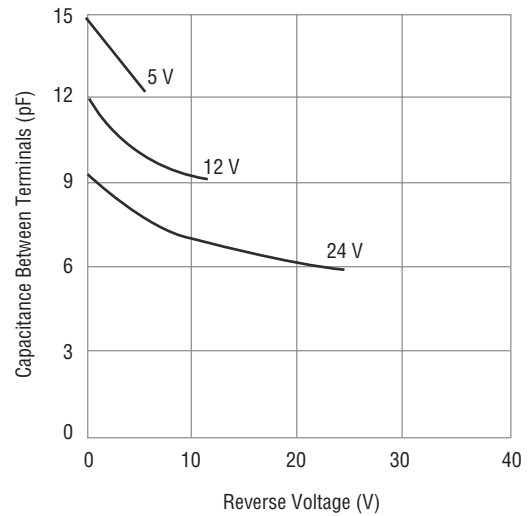

Specifications are subject to change without notice.  
 Customers should verify actual device performance in their specific applications.

# CDDFN2-TxxC Series - Surface Mount TVS Diode

**BOURNS®**

## Packaging Information

The surface mount product is packaged in an 8 mm x 4 mm tape and reel format per EIA-481 standard.

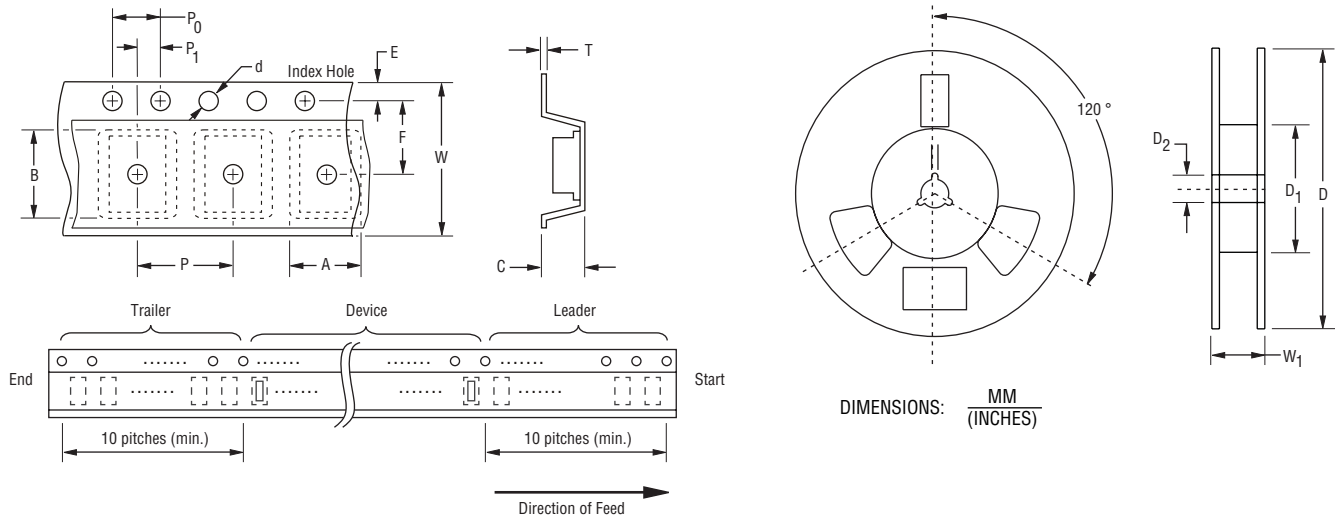

Item	Symbol	DFN-2
Carrier Width	A	$\frac{0.80 \pm 0.10}{(0.031 \pm 0.004)}$
Carrier Length	B	$\frac{1.20 \pm 0.10}{(0.047 \pm 0.004)}$
Carrier Depth	C	$\frac{0.70 \pm 0.10}{(0.027 \pm 0.004)}$
Sprocket Hole	d	$\frac{1.55 \pm 0.05}{(0.061 \pm 0.002)}$
Reel Outside Diameter	D	$\frac{178}{(7.008)}$
Reel Inner Diameter	D <sub>1</sub>	$\frac{50.0}{(1.969)}$ MIN.
Feed Hole Diameter	D <sub>2</sub>	$\frac{13.0 \pm 0.20}{(0.512 \pm 0.008)}$
Sprocket Hole Position	E	$\frac{1.75 \pm 0.10}{(0.069 \pm 0.004)}$
Punch Hole Position	F	$\frac{3.50 \pm 0.05}{(0.138 \pm 0.002)}$
Punch Hole Pitch	P	$\frac{4.00 \pm 0.10}{(0.157 \pm 0.004)}$
Sprocket Hole Pitch	P <sub>0</sub>	$\frac{4.00 \pm 0.10}{(0.157 \pm 0.004)}$
Embossment Center	P <sub>1</sub>	$\frac{2.00 \pm 0.05}{(0.079 \pm 0.002)}$
Overall Tape Thickness	T	$\frac{0.20 \pm 0.10}{(0.008 \pm 0.004)}$
Tape Width	W	$\frac{8.00 \pm 0.20}{(0.315 \pm 0.008)}$
Reel Width	W <sub>1</sub>	$\frac{14.4}{(0.567)}$ MAX.
Quantity per Reel	--	5000

REV. 03/11

Specifications are subject to change without notice.  
Customers should verify actual device performance in their specific applications.