



Features

- Lead free
- RoHS compliant*
- Low profile package
- Surface mount
- Very low forward voltage drop

Applications

- Cellular phones
- PDAs
- Desktop PCs and notebooks
- Digital cameras
- MP3 players

CD1607-B120 ~ B140L Schottky Barrier Rectifier Chip Diode

General Information

The markets of portable communications, computing and video equipment are challenging the semiconductor industry to develop increasingly smaller electronic components.

Bourns offers Schottky Rectifier Diodes for rectification applications, in compact chip package 1607 (Mini-SMA) size format, which offer PCB real estate savings and are considerably smaller than competitive parts. The Schottky Rectifier Diodes offer a forward current of 1 A with a choice of repetitive peak reverse voltage of 20 V up to 40 V.

Bourns® Chip Diodes conform to JEDEC standards, easy to handle on standard pick and place equipment and their flat configuration makes roll away much more difficult.

Electrical Characteristics (@ T_A = 25 °C Unless Otherwise Noted)

Parameter	Symbol	CD1607-				Unit
		B120	B120L	B140	B140L	
Forward Voltage (Max.) (I _f = 1 A)	V _F	0.5	0.38	0.5	0.4	V
Typical Junction Capacitance*	C _T	110	100	110	110	pF
Reverse Current (Max.) at Rated V _R	I _R	0.5	1.0	0.5	1.0	mA

* Measured at 1.0 MHz and applied reverse voltage of 4.0 V DC.

Absolute Ratings (@ T_A = 25 °C Unless Otherwise Noted)

Parameter	Symbol	CD1607-				Unit
		B120	B120L	B140	B140L	
Repetitive Peak Reverse Voltage	V _{RRM}	20	20	40	40	V
Reverse Voltage	V _R	20	20	40	40	V
Maximum RMS Voltage	V _{RMS}	14	14	28	28	V
Avg. Forward Current	I _O	1				A
Forward Current, Surge Peak (60 Hz, 1 cycle)	I _{surge}	30*				A
Typical Thermal Resistance**	R _{θJL}	20				°C/W
Storage Temperature	T _{STG}	-55 to +150				°C
Junction Temperature	T _J	-55 to +125				°C

** Thermal resistance junction to lead.

* Condition: 8.3 ms single half sine-wave superimposed on rate load (JEDEC method).



Reliable Electronic Solutions

Asia-Pacific: Tel: +886-2 2562-4117 • Fax: +886-2 2562-4116

Europe: Tel: +41-41 768 5555 • Fax: +41-41 768 5510

The Americas: Tel: +1-951 781-5500 • Fax: +1-951 781-5700

www.bourns.com

*RoHS Directive 2002/95/EC Jan 27 2003 including Annex

Specifications are subject to change without notice.

Customers should verify actual device performance in their specific applications.

How To Order

Common Code	CD 1607 - B 1 20 L LF
Chip Diode	
Package	
• 1607 = Mini-SMA	
Model	
B = Schottky Barrier Series	
Average Forward Current (I _O) Code	
1 = 1 A (Code x 1000 mA = Average Forward Current)	
Reverse Voltage (V _R) Code	
20 = 20 V	
40 = 40 V	
Forward Voltage Suffix	
L = Low Forward Voltage V _f (CD1607-B120L, CD1607-B140L)	
Terminations	
LF = 100 % Sn (lead free)	

CD1607-B120 ~ B140L Schottky Barrier Rectifier Chip Diode



Product Dimensions

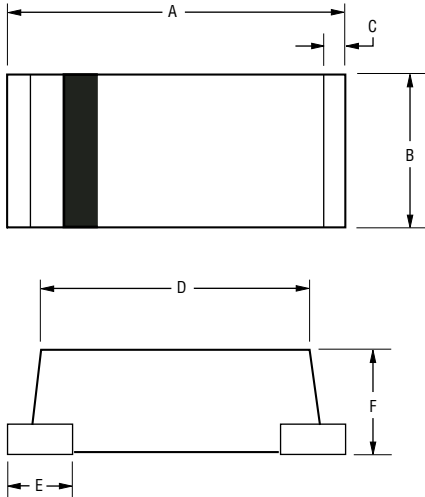

Dimension	Mini-SMA
A	$\frac{3.70 - 4.10}{(0.146 - 0.161)}$
B	$\frac{1.40 - 1.80}{(0.055 - 0.071)}$
C	$\frac{0.30}{(0.012)}$ TYP.
D	$\frac{2.40 - 2.80}{(0.094 - 0.110)}$
E	2 PLCS. $\frac{0.90}{(0.035)}$ TYP.
F	$\frac{1.40 - 1.60}{(0.055 - 0.063)}$

DIMENSIONS: $\frac{\text{MM}}{\text{(INCHES)}}$

Recommended Pad Layout

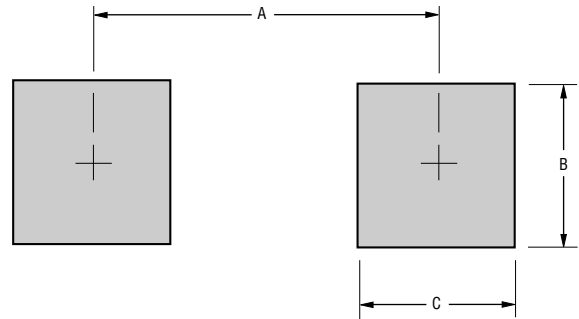

Dimension	Mini-SMA
A (Max.)	$\frac{3.50}{(0.138)}$
B (Min.)	$\frac{1.50}{(0.059)}$
C (Min.)	$\frac{1.50}{(0.059)}$

DIMENSIONS: $\frac{\text{MM}}{\text{(INCHES)}}$

Physical Specifications

Case.....1607 Molded plastic
 PolarityColor band denotes cathode end
 Terminals.....Solderable per MIL-STD-750, Method 206
 WeightApproximately 0.04 grams

Typical Part Marking

CD1607-B120L2
 CD1607-B120LL2
 CD1607-B140L4
 CD1607-B140LL4

CD1607-B120 ~ B140L Schottky Barrier Rectifier Chip Diode

BOURNS®

Rating and Characteristic Curves: CD1607-B120 & CD1607-B140

Forward Characteristics

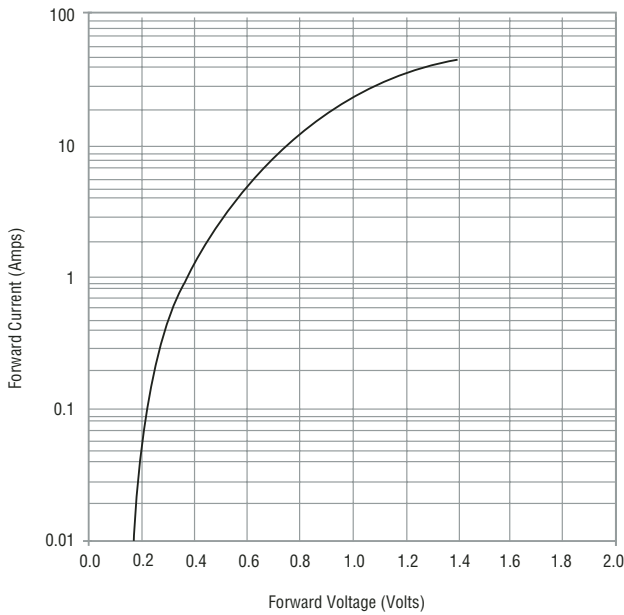

Reverse Characteristics

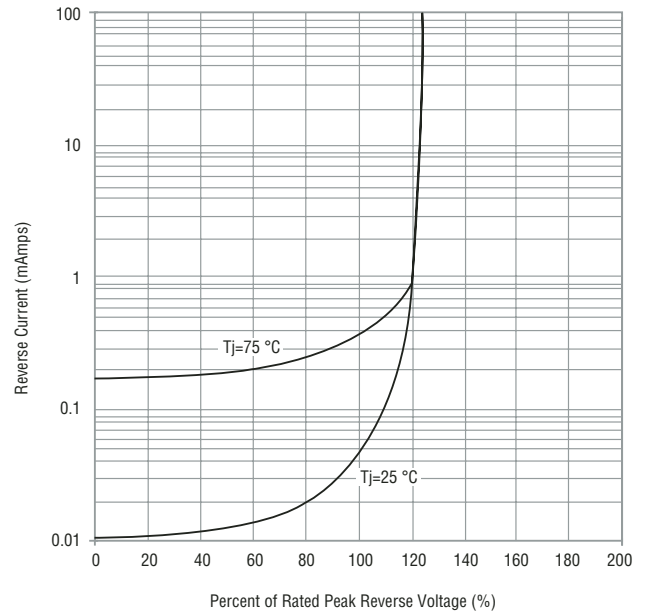

Derating Curve

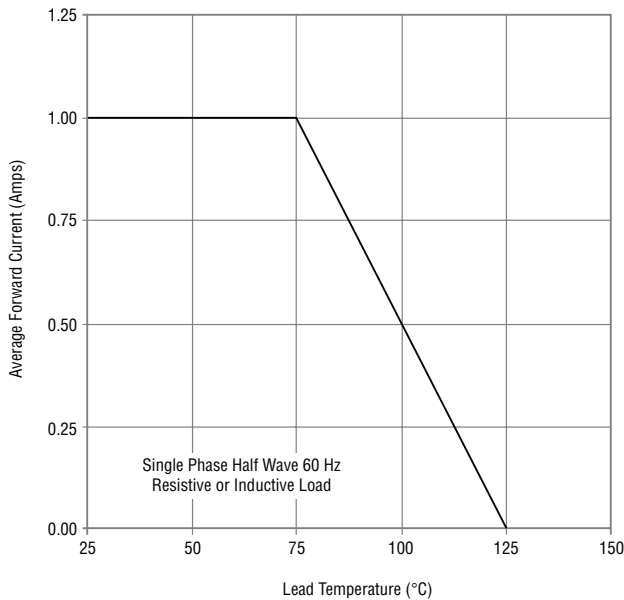

Capacitance Between Terminals

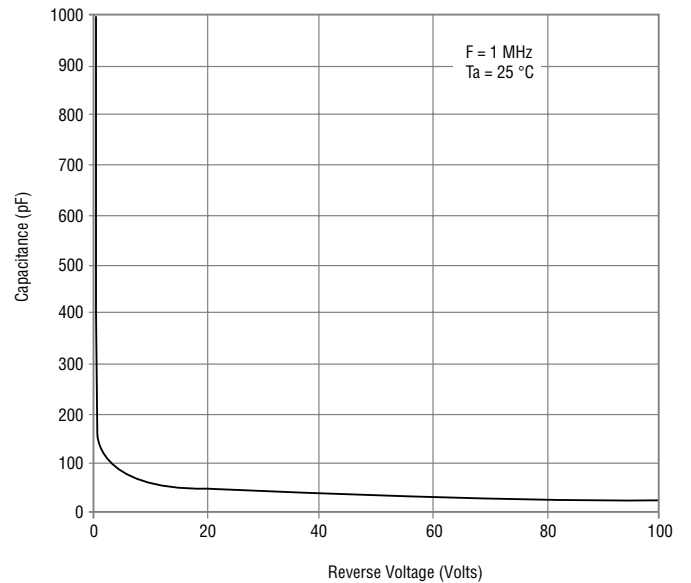

Specifications are subject to change without notice. Customers should verify actual device performance in their specific applications.

CD1607-B120 ~ B140L Schottky Barrier Rectifier Chip Diode



Rating and Characteristic Curves: CD1607-B120L & CD1607-B140L

Forward Characteristics

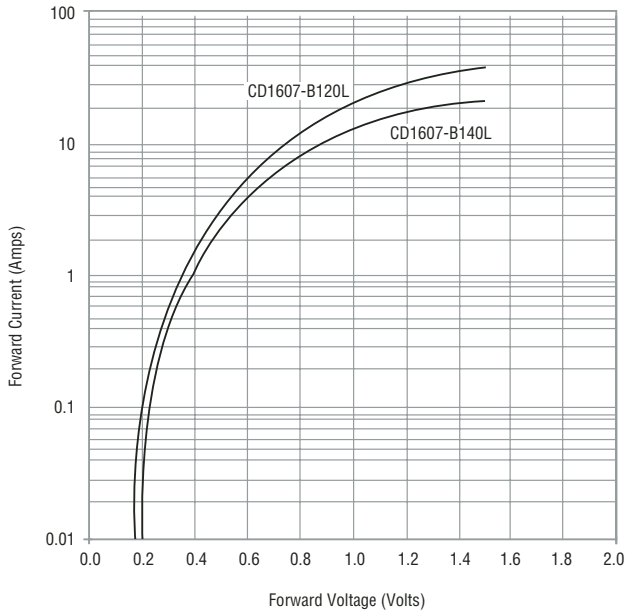

Reverse Characteristics

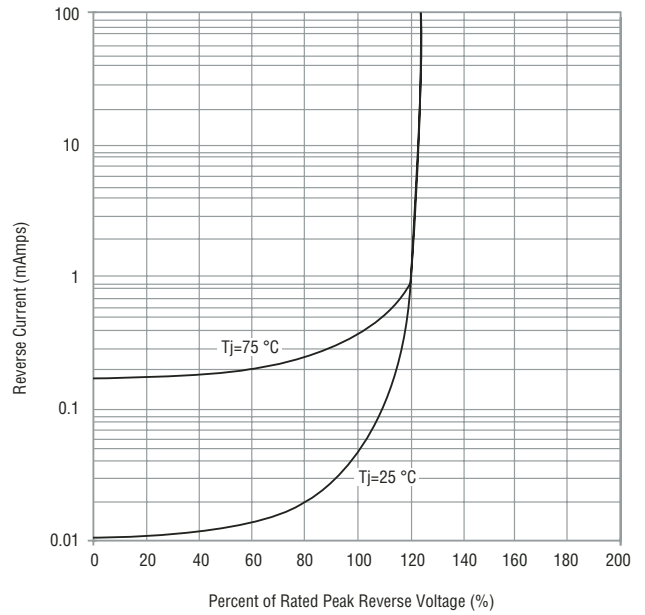

Derating Curve

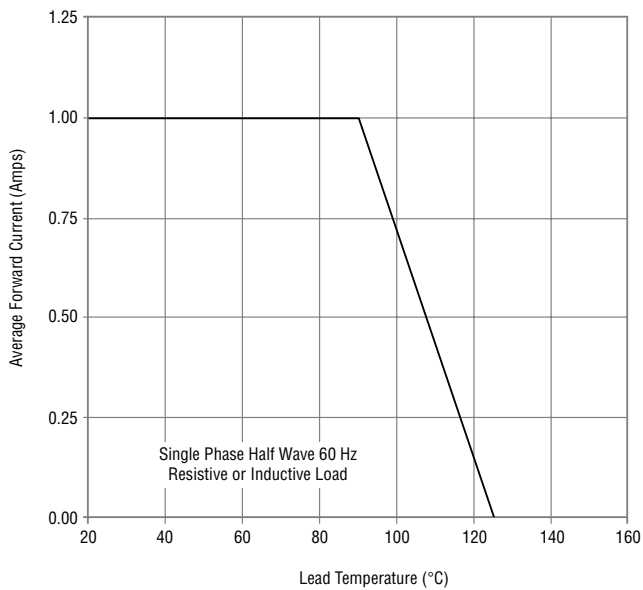

Capacitance Between Terminals

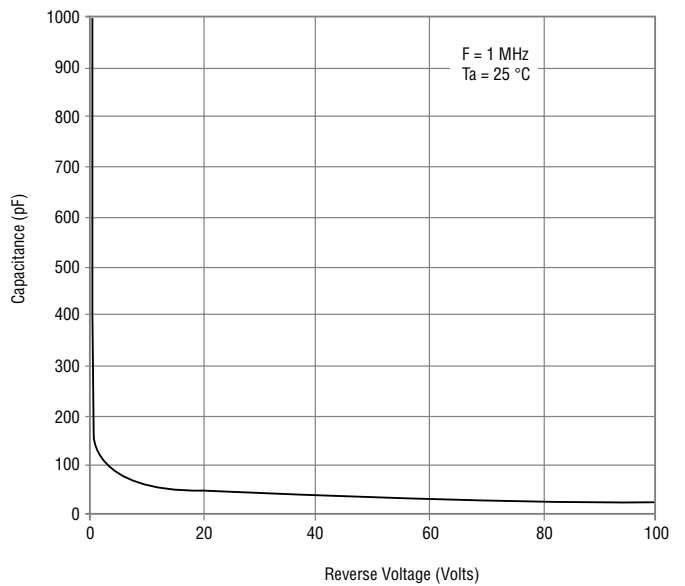

Specifications are subject to change without notice. Customers should verify actual device performance in their specific applications.

CD1607-B120 ~ B140L Schottky Barrier Rectifier Chip Diode

BOURNS®

Packaging Information

The product will be dispensed in Tape and Reel format (see diagram below).

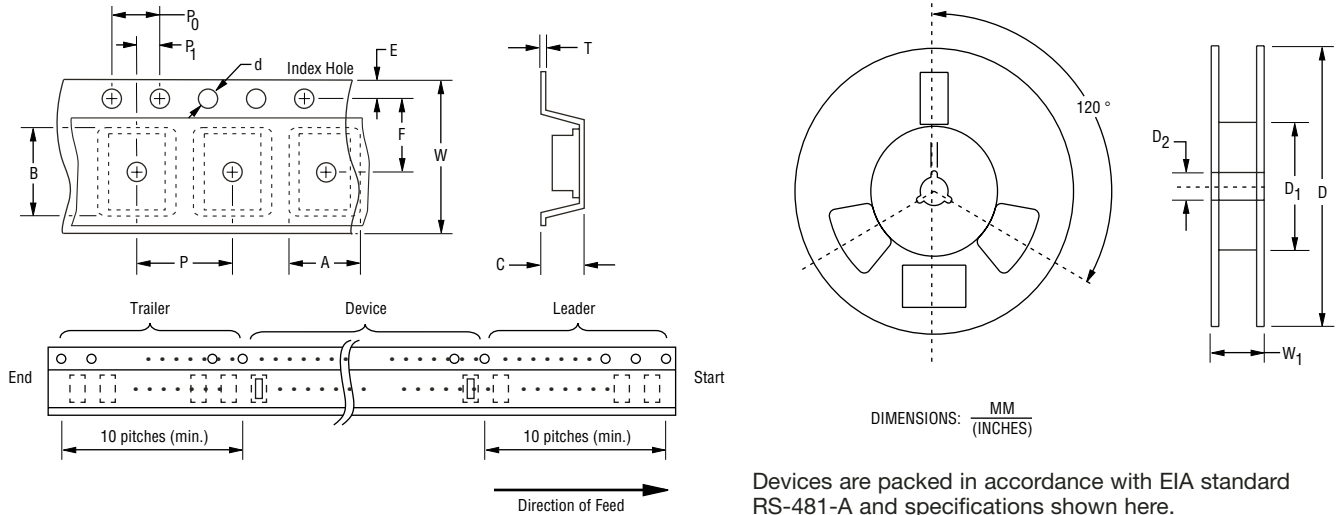

Item	Symbol	1607
Carrier Width	A	$\frac{1.90 \pm 0.10}{(0.075 - 0.004)}$
Carrier Length	B	$\frac{4.30 \pm 0.10}{(0.169 - 0.004)}$
Carrier Depth	C	$\frac{1.80 \pm 0.10}{(0.071 - 0.004)}$
Sprocket Hole	d	$\frac{1.55 \pm 0.05}{(0.061 - 0.002)}$
Reel Outside Diameter	D	$\frac{178}{(7.008)}$
Reel Inner Diameter	D ₁	$\frac{80.0}{(3.150)}$ MIN.
Feed Hole Diameter	D ₂	$\frac{13.0 \pm 0.20}{(0.512 - 0.008)}$
Sprocket Hole Position	E	$\frac{1.75 \pm 0.10}{(0.069 - 0.004)}$
Punch Hole Position	F	$\frac{3.50 \pm 0.05}{(0.138 - 0.002)}$
Punch Hole Pitch	P	$\frac{4.00 \pm 0.10}{(0.157 - 0.004)}$
Sprocket Hole Pitch	P ₀	$\frac{4.00 \pm 0.10}{(0.157 - 0.004)}$
Embossment Center	P ₁	$\frac{2.00 \pm 0.05}{(0.079 - 0.002)}$
Overall Tape Thickness	T	$\frac{0.20 \pm 0.10}{(0.008 - 0.004)}$
Tape Width	W	$\frac{8.00 \pm 0.20}{(0.315 - 0.008)}$
Reel Width	W ₁	$\frac{13.5}{(0.531)}$ MAX.
Quantity per Reel	--	2,500

REV. 01/08

Specifications are subject to change without notice.
Customers should verify actual device performance in their specific applications.