

High Performance Schottky Generation 5.0, 20 A

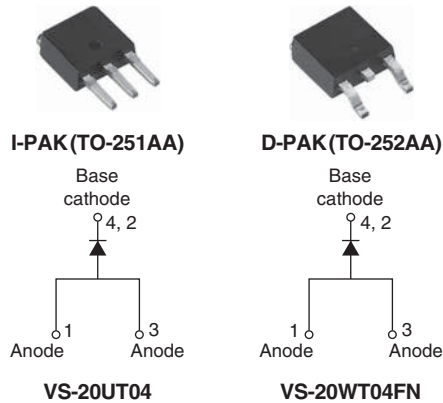

FEATURES

- 175 °C high performance Schottky diode
- Very low forward voltage drop
- Extremely low reverse leakage
- Optimized V_F vs. I_F trade off for high efficiency
- Increased ruggedness for reverse avalanche capability
- RBSOA available
- Negligible switching losses
- Submicron trench technology
- Compliant to RoHS Directive 2002/95/EC

RoHS
COMPLIANT

PRODUCT SUMMARY	
Package	D-PAK (TO-252AA), I-PAK (TO-251AA)
$I_{F(AV)}$	20 A
V_R	45 V
V_F at I_F	0.53 V
I_{RM} max.	7 mA at 125 °C
T_J max.	175 °C
Diode variation	Single die
E_{AS}	108 mJ

Note

- V_F measured at 125 °C, connecting 2 anode pins

APPLICATIONS

- Specific for PV cells bypass diode
- High efficiency SMPS
- High frequency switching
- Output rectification
- Reverse battery protection
- Freewheeling
- DC/DC systems
- Increased power density systems

MAJOR RATINGS AND CHARACTERISTICS			
SYMBOL	CHARACTERISTICS	VALUES	UNITS
V_{RRM}		45	V
V_F	20 Apk, $T_J = 125$ °C (typical, measured connecting 2 anode pins)	0.480	V
T_J	Range	- 55 to 175	°C

VOLTAGE RATINGS				
PARAMETER	SYMBOL	TEST CONDITIONS	VS-20UT04 VS-20WT04FN	UNITS
Maximum DC reverse voltage	V_R	$T_J = 25$ °C	45	V

VS-20UT04, VS-20WT04FN



Vishay Semiconductors

High Performance Schottky
Generation 5.0, 20 A

ABSOLUTE MAXIMUM RATINGS					
PARAMETER	SYMBOL	TEST CONDITIONS		VALUES	UNITS
Maximum average forward current	$I_{F(AV)}$	50 % duty cycle at $T_C = 153\text{ }^\circ\text{C}$, rectangular waveform		20	A
Maximum peak one cycle non-repetitive surge current	I_{FSM}	5 μs sine or 3 μs rect. pulse	Following any rated load condition and with rated V_{RRM} applied ⁽¹⁾	900	A
		10 ms sine or 6 ms rect. pulse		220	
Non-repetitive avalanche energy	E_{AS}	$T_J = 25\text{ }^\circ\text{C}$, $I_{AS} = 7\text{ A}$, $L = 4.4\text{ mH}$		108	mJ
Repetitive avalanche current	I_{AR}	Limited by frequency of operation and time pulse duration so that $T_J < T_{J\text{max}}$. I_{AS} at $T_{J\text{max}}$ as a function of time pulse		I_{AS} at $T_{J\text{max}}$.	A

Note

⁽¹⁾ Measured connecting 2 anode pins

ELECTRICAL SPECIFICATIONS						
PARAMETER	SYMBOL	TEST CONDITIONS		TYP.	MAX.	UNITS
Forward voltage drop	V_{FM} ⁽¹⁾⁽²⁾	10 A	$T_J = 25\text{ }^\circ\text{C}$	0.505	0.540	V
		20 A		0.570	0.610	
		10 A	$T_J = 125\text{ }^\circ\text{C}$	0.415	0.450	
		20 A		0.520	0.580	
Reverse leakage current	I_{RM} ⁽¹⁾	$T_J = 25\text{ }^\circ\text{C}$	$V_R = \text{Rated } V_R$	-	100	μA
		$T_J = 125\text{ }^\circ\text{C}$		-	7	mA
Junction capacitance	C_T	$V_R = 5\text{ V}_{DC}$ (test signal range 100 kHz to 1 MHz), $25\text{ }^\circ\text{C}$		1900	-	pF
Series inductance	L_S	Measured lead to lead 5 mm from package body		-	-	nH
Maximum voltage rate of change	dV/dt	Rated V_R		-	10 000	V/ μs

Notes

- ⁽¹⁾ Pulse width < 300 μs , duty cycle < 2 %
- ⁽²⁾ Only 1 anode pin connected

THERMAL - MECHANICAL SPECIFICATIONS					
PARAMETER	SYMBOL	TEST CONDITIONS		VALUES	UNITS
Maximum junction and storage temperature range	T_J, T_{Stg}			- 55 to 175	$^\circ\text{C}$
Maximum thermal resistance, junction to case	R_{thJC}	DC operation		1.2	$^\circ\text{C/W}$
Typical thermal resistance, case to heatsink	R_{thCS}			0.3	
Approximate weight				2	g
				0.07	oz.
Marking device		Case style I-PAK		20UT04	
		Case style D-PAK		20WT04FN	

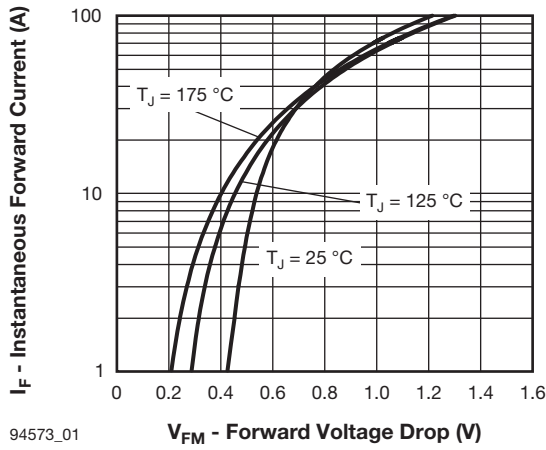

Fig. 1 - Maximum Forward Voltage Drop Characteristics

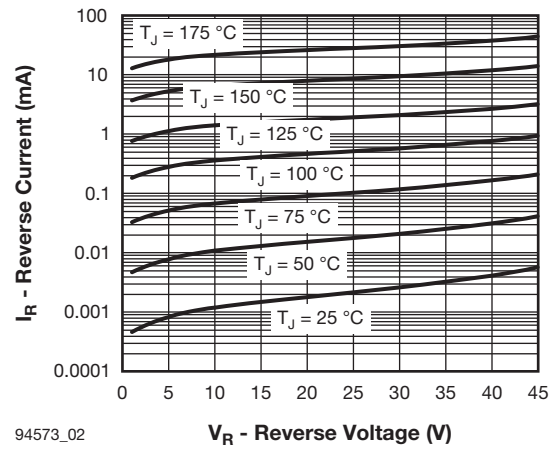

Fig. 2 - Typical Values of Reverse Current vs. Reverse Voltage

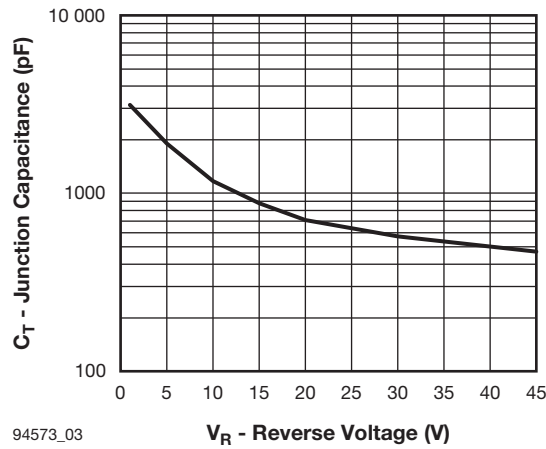

Fig. 3 - Typical Junction Capacitance vs. Reverse Voltage

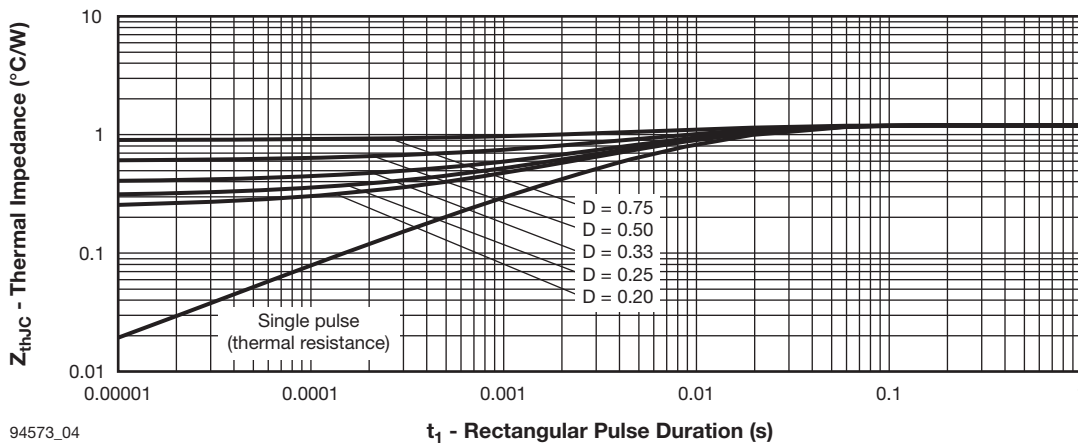

Fig. 4 - Maximum Thermal Impedance Z_{thJC} Characteristics

VS-20UT04, VS-20WT04FN



Vishay Semiconductors

High Performance Schottky
Generation 5.0, 20 A

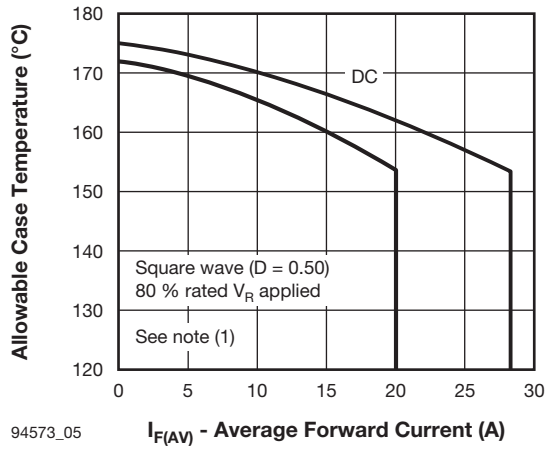

Fig. 5 - Maximum Allowable Case Temperature vs. Average Forward Current

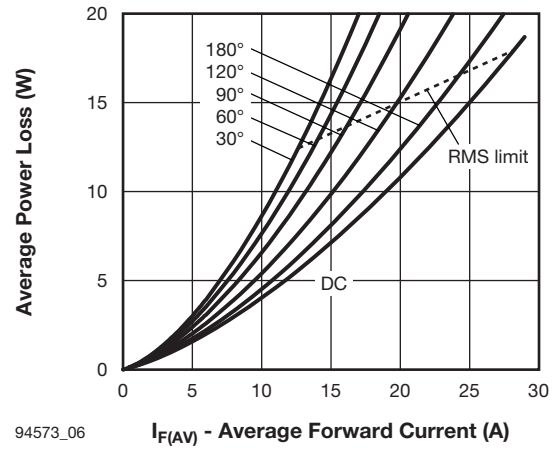

Fig. 6 - Forward Power Loss Characteristics

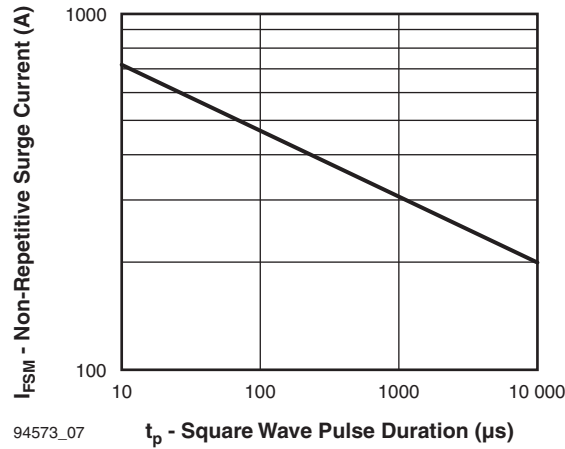
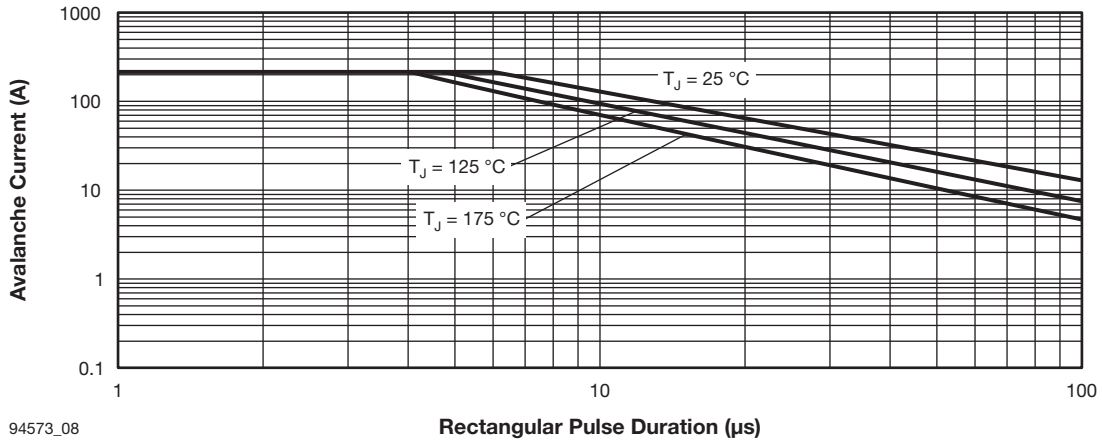

Fig. 7 - Maximum Non-Repetitive Surge Current

Note

- (1) Formula used: $T_C = T_J - (P_d + P_{d_{REV}}) \times R_{thJC}$;
 P_d = Forward power loss = $I_{F(AV)} \times V_{FM}$ at $(I_{F(AV)}/D)$ (see fig. 6);
 $P_{d_{REV}}$ = Inverse power loss = $V_{R1} \times I_R (1 - D)$; I_R at $V_{R1} = 80\%$ rated V_R



94573_08

Fig. 8 - Reverse Bias Safe Operating Area (Avalanche Current vs. Rectangular Pulse Duration)

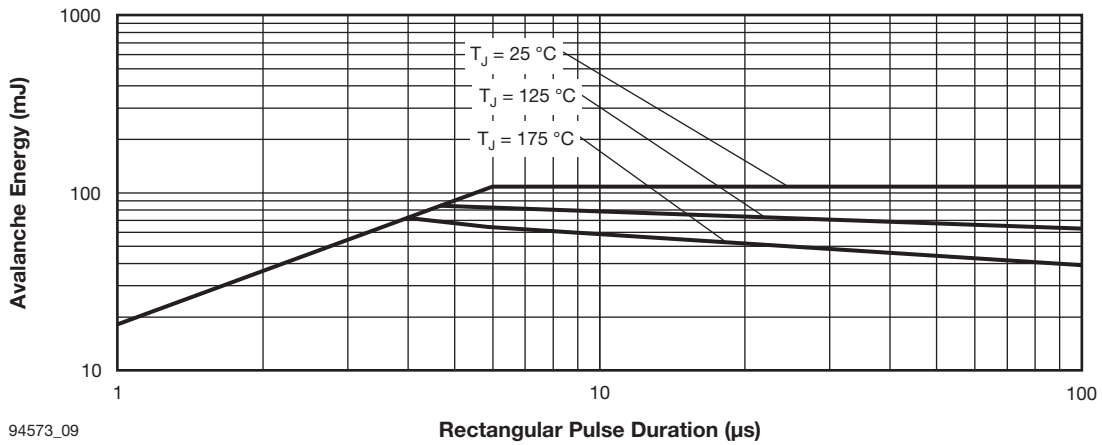

94573_09

Fig. 9 - Reverse Bias Safe Operating Area (Avalanche Energy vs. Rectangular Pulse Duration)

VS-20UT04, VS-20WT04FN

Vishay Semiconductors

High Performance Schottky
Generation 5.0, 20 A



ORDERING INFORMATION TABLE

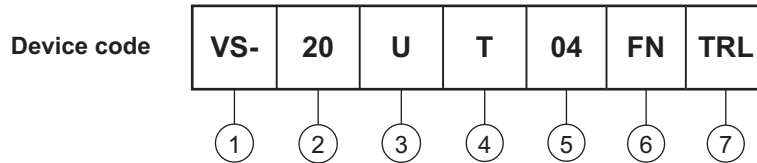

- 1** - Vishay Semiconductors product
- 2** - Current rating (20 A)
- 3** - Package:
 - U = I-PAK
 - W = D-PAK
- 4** - T = Trench
- 5** - Voltage code (45 V)
- 6** - TO-252AA (D-PAK)
- 7** - D-PAK, I-PAK:
 - None = Tube (75 pieces)
 - D-PAK only:
 - TR = Tape and reel
 - TRL = Tape and reel (left oriented)
 - TRR = Tape and reel (right oriented)

LINKS TO RELATED DOCUMENTS	
Dimensions	www.vishay.com/doc?95024
Part marking information	www.vishay.com/doc?95025
Packaging information	www.vishay.com/doc?95033
SPIICE model	www.vishay.com/doc?95027



Disclaimer

ALL PRODUCT, PRODUCT SPECIFICATIONS AND DATA ARE SUBJECT TO CHANGE WITHOUT NOTICE TO IMPROVE RELIABILITY, FUNCTION OR DESIGN OR OTHERWISE.

Vishay Intertechnology, Inc., its affiliates, agents, and employees, and all persons acting on its or their behalf (collectively, "Vishay"), disclaim any and all liability for any errors, inaccuracies or incompleteness contained in any datasheet or in any other disclosure relating to any product.

Vishay makes no warranty, representation or guarantee regarding the suitability of the products for any particular purpose or the continuing production of any product. To the maximum extent permitted by applicable law, Vishay disclaims (i) any and all liability arising out of the application or use of any product, (ii) any and all liability, including without limitation special, consequential or incidental damages, and (iii) any and all implied warranties, including warranties of fitness for particular purpose, non-infringement and merchantability.

Statements regarding the suitability of products for certain types of applications are based on Vishay's knowledge of typical requirements that are often placed on Vishay products in generic applications. Such statements are not binding statements about the suitability of products for a particular application. It is the customer's responsibility to validate that a particular product with the properties described in the product specification is suitable for use in a particular application. Parameters provided in datasheets and/or specifications may vary in different applications and performance may vary over time. All operating parameters, including typical parameters, must be validated for each customer application by the customer's technical experts. Product specifications do not expand or otherwise modify Vishay's terms and conditions of purchase, including but not limited to the warranty expressed therein.

Except as expressly indicated in writing, Vishay products are not designed for use in medical, life-saving, or life-sustaining applications or for any other application in which the failure of the Vishay product could result in personal injury or death. Customers using or selling Vishay products not expressly indicated for use in such applications do so at their own risk and agree to fully indemnify and hold Vishay and its distributors harmless from and against any and all claims, liabilities, expenses and damages arising or resulting in connection with such use or sale, including attorneys fees, even if such claim alleges that Vishay or its distributor was negligent regarding the design or manufacture of the part. Please contact authorized Vishay personnel to obtain written terms and conditions regarding products designed for such applications.

No license, express or implied, by estoppel or otherwise, to any intellectual property rights is granted by this document or by any conduct of Vishay. Product names and markings noted herein may be trademarks of their respective owners.