

HFA25TB60PbF

Ultrafast, Soft Recovery Diode

HEXFRED™

Features

- Ultrafast Recovery
- Ultrasoft Recovery
- Very Low I_{RRM}
- Very Low Q_{rr}
- Specified at Operating Conditions
- Lead-Free

Benefits

- Reduced RFI and EMI
- Reduced Power Loss in Diode and Switching Transistor
- Higher Frequency Operation
- Reduced Snubbing
- Reduced Parts Count

Description

International Rectifier's HFA25TB60 is a state of the art ultra fast recovery diode. Employing the latest in epitaxial construction and advanced processing techniques it features a superb combination of characteristics which result in performance which is unsurpassed by any rectifier previously available. With basic ratings of 600 volts and 25 amps continuous current, the HFA25TB60 is especially well suited for use as the companion diode for IGBTs and MOSFETs. In addition to ultra fast recovery time, the HEXFRED product line features extremely low values of peak recovery current (I_{RRM}) and does not exhibit any tendency to "snap-off" during the t_b portion of recovery. The HEXFRED features combine to offer designers a rectifier with lower noise and significantly lower switching losses in both the diode and the switching transistor. These HEXFRED advantages can help to significantly reduce snubbing, component count and heatsink sizes. The HEXFRED HFA25TB60 is ideally suited for applications in power supplies and power conversion systems (such as inverters), motor drives, and many other similar applications where high speed, high efficiency is needed.

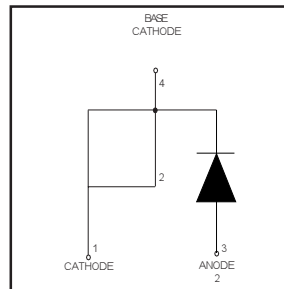

$V_R = 600V$
$V_F(\text{typ.})^* = 1.3V$
$I_{F(AV)} = 25A$
$Q_{rr}(\text{typ.}) = 112nC$
$I_{RRM} = 10A$
$t_{rr}(\text{typ.}) = 23ns$
$di_{(rec)M}/dt(\text{typ.}) = 250A/\mu s$

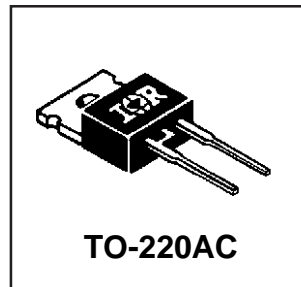

Absolute Maximum Ratings

	Parameter	Max	Units
V_R	Cathode-to-Anode Voltage	600	V
$I_F @ T_C = 100^\circ C$	Continuous Forward Current	25	A
I_{FSM}	Single Pulse Forward Current	225	
I_{FRM}	Maximum Repetitive Forward Current	100	
$P_D @ T_C = 25^\circ C$	Maximum Power Dissipation	125	C
$P_D @ T_C = 100^\circ C$	Maximum Power Dissipation	50	
T_J	Operating Junction and	-55 to +150	W
T_{STG}	Storage Temperature Range		

* 125°C
Document Number: 94065

10/19/04
www.vishay.com

Electrical Characteristics @ T_J = 25°C (unless otherwise specified)

	Parameter	Min	Typ	Max	Units	Test Conditions
V _{BR}	Cathode Anode Breakdown Voltage	600			V	I _R = 100μA
V _{FM}	Max Forward Voltage		1.3	1.7	V	I _F = 25A
			1.5	2.0		I _F = 50A
			1.3	1.7		I _F = 25A, T _J = 125°C
I _{RM}	Max Reverse Leakage Current		1.5	20	μA	V _R = V _R Rated
			600	2000		T _J = 125°C, V _R = 0.8 x V _R Rated
C _T	Junction Capacitance		55	100	pF	V _R = 200V
L _S	Series Inductance		8.0		nH	Measured lead to lead 5mm from package body

Dynamic Recovery Characteristics @ T_J = 25°C (unless otherwise specified)

	Parameter	Min	Typ	Max	Units	Test Conditions
t _{rr}	Reverse Recovery Time		23		ns	I _F = 1.0A, di _F /dt = 200A/μs, V _R = 30V
t _{rr1}	See Fig. 5, 6 & 16		50	75		T _J = 25°C
t _{rr2}			105	160		T _J = 125°C
I _{RRM1}	Peak Recovery Current		4.5	10	A	T _J = 25°C
I _{RRM2}	See Fig. 7 & 8		8.0	15		T _J = 125°C
Q _{rr1}	Reverse Recovery Charge		112	375	nC	T _J = 25°C
Q _{rr2}	See Fig. 9 & 10		420	1200		T _J = 125°C
di _{(rec)M} /dt1	Peak Rate of Fall of Recovery Current		250		A/μs	T _J = 25°C
di _{(rec)M} /dt2	During t _b See Fig. 11 & 12		160			T _J = 125°C

Thermal - Mechanical Characteristics

	Parameter	Min	Typ	Max	Units
T _{lead} ①	Lead Temperature			300	°C
R _{thJC}	Thermal Resistance, Junction to Case			1.0	K/W
R _{thJA} ②	Thermal Resistance, Junction to Ambient			80	
R _{thCS} ③	Thermal Resistance, Case to Heat Sink		0.5		
Wt	Weight		2.0		g
			0.07		(oz)
	Mounting Torque		6.0	12	Kg-cm
			5.0	10	lbf-in

① 0.063 in. from Case (1.6mm) for 10 sec

② Typical Socket Mount

③ Mounting Surface, Flat, Smooth and Greased

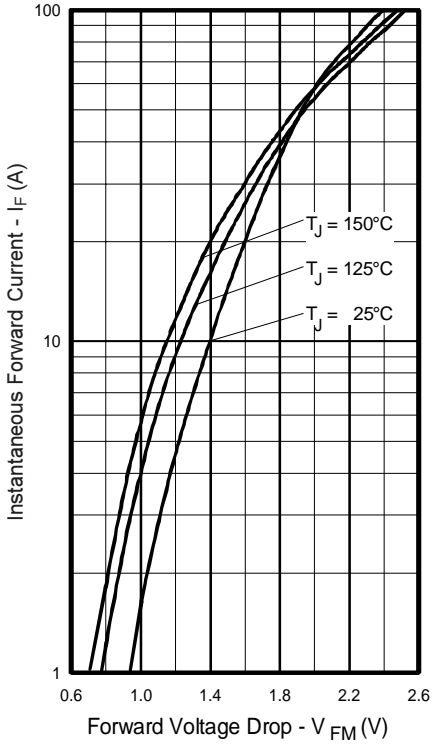

Fig. 1 - Maximum Forward Voltage Drop vs. Instantaneous Forward Current

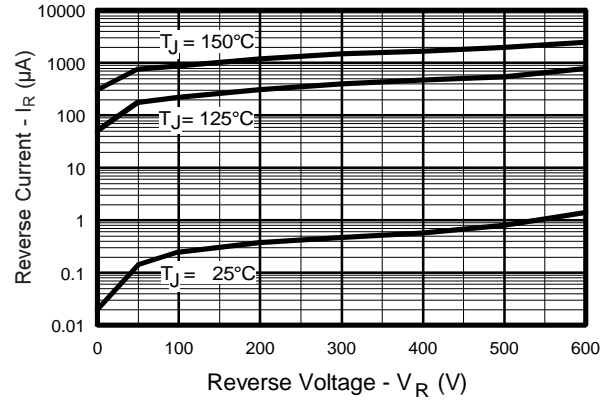

Fig. 2 - Typical Reverse Current vs. Reverse Voltage

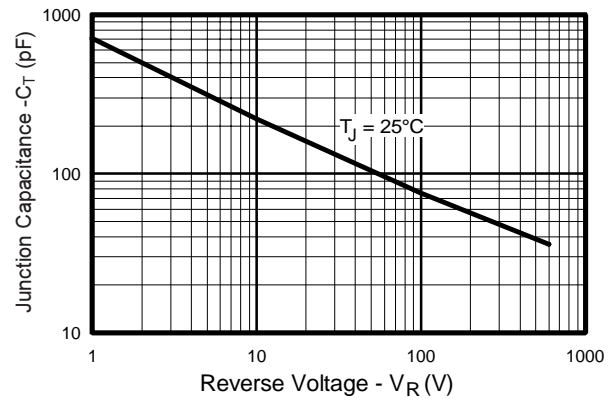

Fig. 3 - Typical Junction Capacitance vs. Reverse Voltage

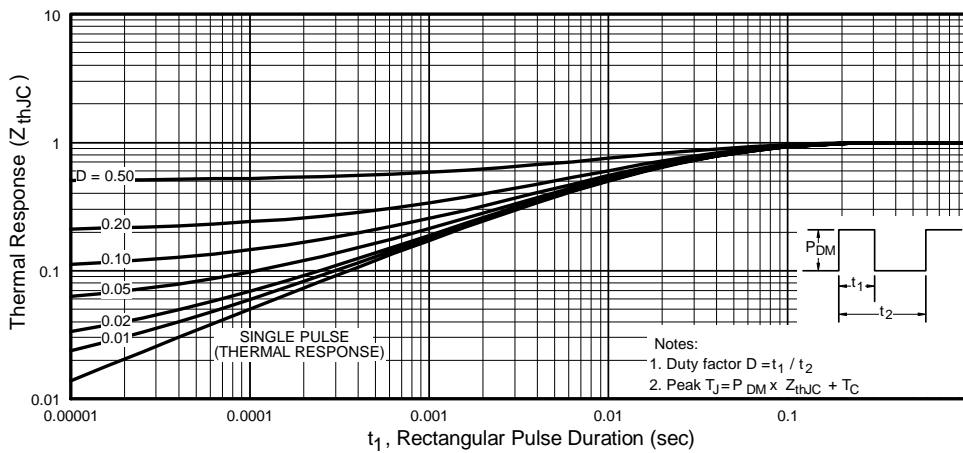

Fig. 4 - Maximum Thermal Impedance Z_{thJC} Characteristics

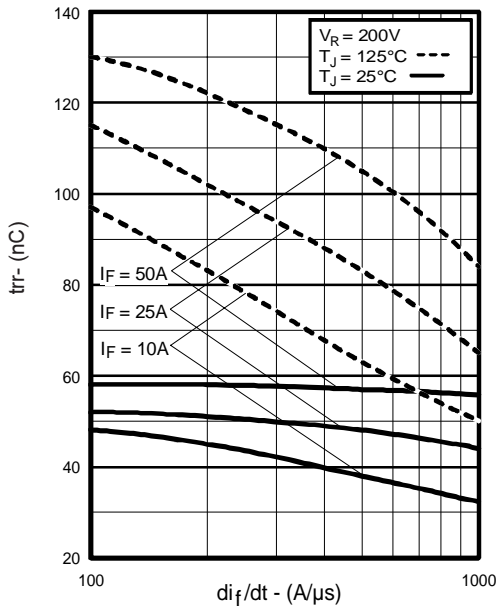

Fig. 5 - Typical Reverse Recovery vs. di_f/dt

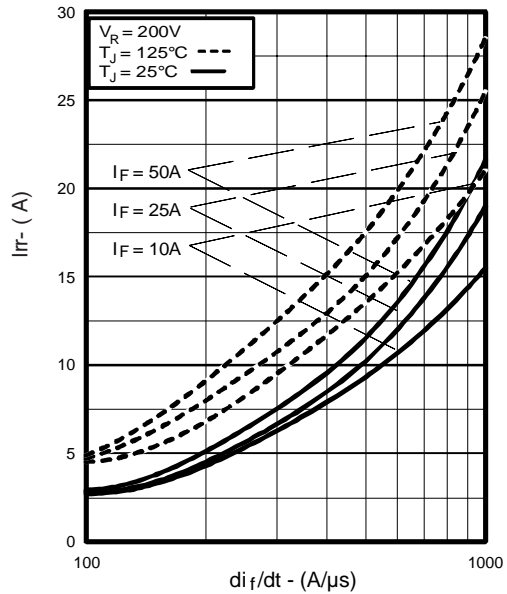

Fig. 6 - Typical Recovery Current vs. di_f/dt

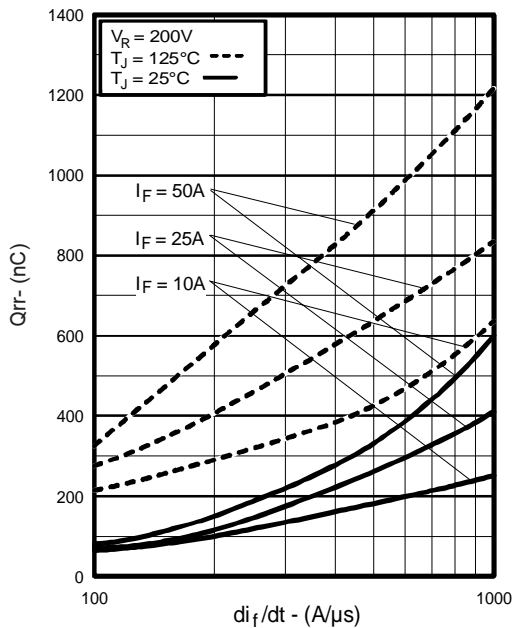

Fig. 7 - Typical Stored Charge vs. di_f/dt

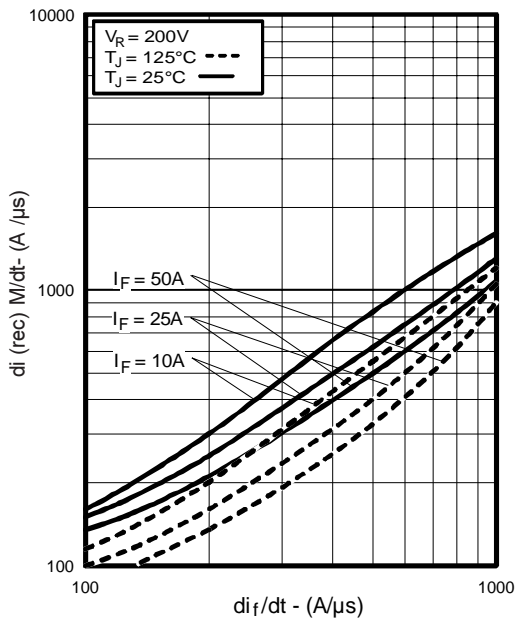

Fig. 8 - Typical $di_{(rec)M}/dt$ vs. di_f/dt

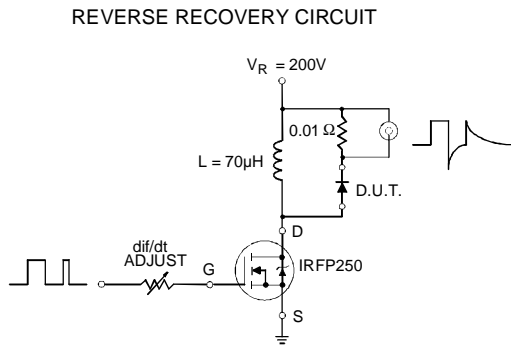

Fig. 9 - Reverse Recovery Parameter Test Circuit

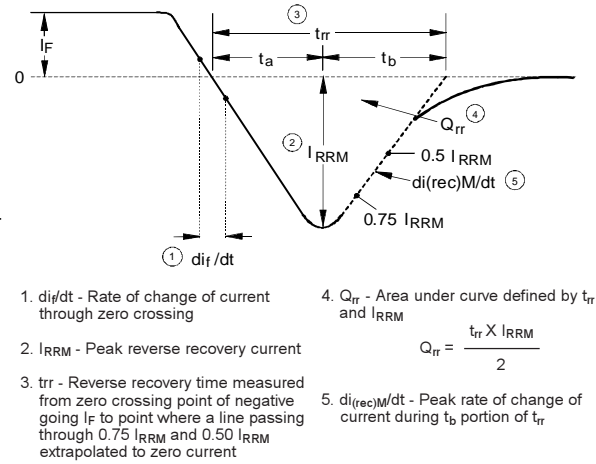
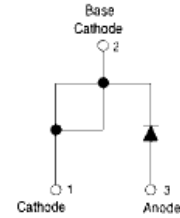
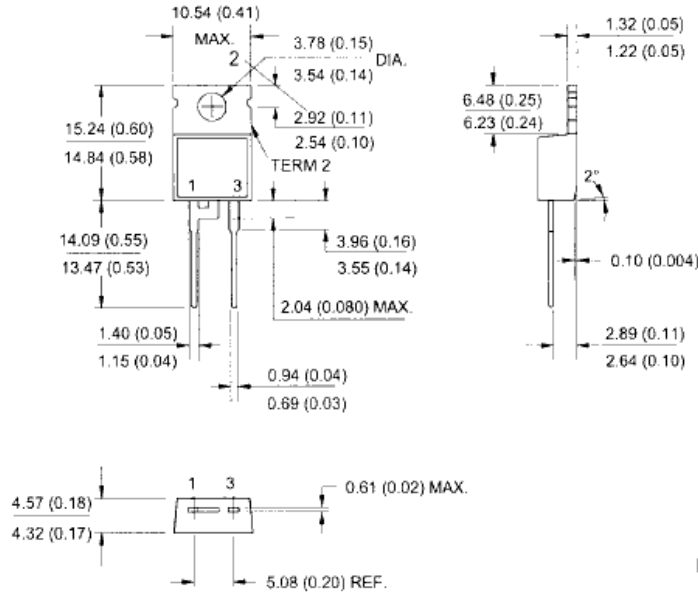

Fig. 10 - Reverse Recovery Waveform and Definitions

HFA25TB60PbF

TO-220AC Package Outline

Dimensions are shown in millimeters (inches)



TO-220AC
Dimensions in millimeters (inches)

TO-220AC Part Marking Information

EXAMPLE: THIS IS A HFA06TB120
LOT CODE 1789
ASSEMBLED ON WW 19, 2001
IN THE ASSEMBLY LINE "C"

Note: "P" in the beginning of date code indicates "Lead-Free"

OR

EXAMPLE: THIS IS A HFA06TB120
LOT CODE 1789
ASSEMBLED ON WW 19, 2001
IN THE ASSEMBLY LINE "C"

Note: "P" in assembly line position indicates "Lead-Free"

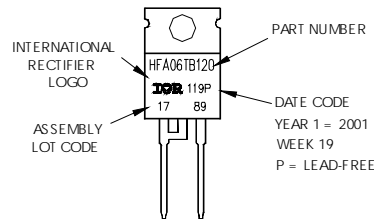
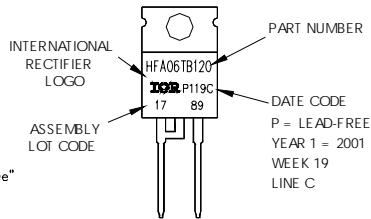

Data and specifications subject to change without notice.

International
IR Rectifier

IR WORLD HEADQUARTERS: 233 Kansas St., El Segundo, California 90245, USA Tel: (310) 252-7105
TAC Fax: (310) 252-7903

Document Number: 94065

10/04
www.vishay.com



Notice

The products described herein were acquired by Vishay Intertechnology, Inc., as part of its acquisition of International Rectifier's Power Control Systems (PCS) business, which closed in April 2007. Specifications of the products displayed herein are pending review by Vishay and are subject to the terms and conditions shown below.

Specifications of the products displayed herein are subject to change without notice. Vishay Intertechnology, Inc., or anyone on its behalf, assumes no responsibility or liability for any errors or inaccuracies.

Information contained herein is intended to provide a product description only. No license, express or implied, by estoppel or otherwise, to any intellectual property rights is granted by this document. Except as provided in Vishay's terms and conditions of sale for such products, Vishay assumes no liability whatsoever, and disclaims any express or implied warranty, relating to sale and/or use of Vishay products including liability or warranties relating to fitness for a particular purpose, merchantability, or infringement of any patent, copyright, or other intellectual property right.

The products shown herein are not designed for use in medical, life-saving, or life-sustaining applications. Customers using or selling these products for use in such applications do so at their own risk and agree to fully indemnify Vishay for any damages resulting from such improper use or sale.

International Rectifier®, IR®, the IR logo, HEXFET®, HEXSense®, HEXDIP®, DOL®, INTERO®, and POWIRTRAIN® are registered trademarks of International Rectifier Corporation in the U.S. and other countries. All other product names noted herein may be trademarks of their respective owners.