

AP562

3.3-3.8 GHz WiMAX 8W Power Amplifier



Product Features

- 3.3 – 3.8 GHz
- +39.4 dBm P1dB
- 11.5 dB Gain
- 2.0% EVM @ 30 dBm Pout
- +12 V Supply Voltage
- Lead-free/green/RoHS-compliant 5x6 mm power DFN package

Applications

- WiMAX CPE/BTS

Product Description

The AP562 is a high dynamic range broadband power amplifier in a surface mount package. The single-stage amplifier has 11.5 dB gain, while being able to achieve high performance for 3.3–3.8 GHz WiMAX applications with up to 39.4 dBm of compressed 1dB power.

The AP562 uses a high reliability +12V InGaP/GaAs HBT process technology. The device incorporates proprietary bias circuitry to compensate for variations in linearity and current draw over temperature. The device does not require any negative bias voltage; an internal active bias allows the AP562 to operate directly off a commonly used +12V supply and has the added feature of a +5V power down control pin. RoHS-compliant 5x6mm DFN package is surface mountable to allow for low manufacturing costs to the end user.

The AP562 is targeted for use in a balanced or single ended configuration for WiMAX applications where high linearity and high power is required.

Functional Diagram

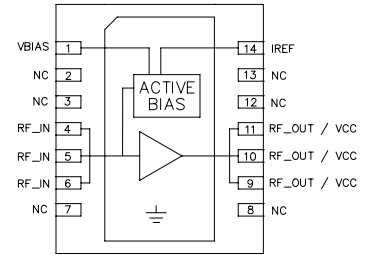

Function	Pin No.
RF _{IN}	4,5,6
RF _{OUT}	9,10,11
I _{REF}	14
V _{BIAS}	1
NC	2,3,7,8,12,13

Specifications

Parameter	Units	Min	Typ	Max
Operational Bandwidth	GHz	3.3		3.8
Test Frequency	GHz		3.5	
Output Channel Power	dBm		+30	
Power Gain	dB		11.5	
Input Return Loss	dB		15	
Output Return Loss	dB		6.7	
Error Vector Magnitude	%		1.9	
Operating Current, I _{cc}	mA		685	
RF Switching Speed	ns		50	
Collector Efficiency	%		11.7	
Output P1dB	dBm		39.4	
Quiescent Current, I _q	mA		400	
V _{pd} ⁽⁴⁾	V		+5	
V _{cc}	V		+12	

Notes:

1. Test conditions unless otherwise noted: T = 25°C, V_{pd} = +5V, V_{cc} = +12, I_q = 400mA at P_{out} = +30 dBm and f = 3.5 GHz.
2. Using an 802.16-2004 OFDMA, 64QAM-1/2, 1024-FFT, 20 symbols, 30 subchannels signal, 9.5 dB PAR @ 0.01%.
3. Switching speed: 50% TTL to 100/0% RF.
4. V_{pd} used for device power down. (low=RF off)
5. Capable of handling 10:1 VSWR @ 12 V_{DC}, WiMax signal, P_{out,AVG} = 30dBm.

Typical Performance

Parameter	Units	Typical		
Test Frequency	GHz	3.4	3.5	3.6
Channel Power	dBm	+30	+30	+30
Power Gain	dB	11.5	11.5	11.3
Input Return Loss	dB	11	15	15
Output Return Loss	dB	5.6	6.7	5.9
Error Vector Magnitude	%	2.2	1.9	1.7
Operating Current, I _{cc}	mA	720	685	670
Collector Efficiency	%	11.1	11.7	12.2
Output P1dB	dBm	39.5	39.4	38.7
Quiescent Current, I _q	mA	400		
V _{pd}	V	+5		
V _{cc}	V	+12		

Absolute Maximum Rating

Parameter	Rating
Pin max (CW into 50Ω load)	+33 dBm
Storage Temperature	-55 to +125 °C
Max Junction Temperature, T _{J,max}	158 °C
Thermal Resistance, Θ _{JC}	8.4 °C / W

Operation of this device above any of these parameters may cause permanent damage.

Ordering Information

Part No.	Description
AP562-F	WiMAX 12V 8W HBT Amplifier
AP562-PCB3500	3.4-3.6 GHz Fully Assembled Evaluation Board

Standard T/R size = 500 pieces on a 7" reel.

Specifications and information are subject to change without notice

AP562

3.3-3.8 GHz WiMAX 8W Power Amplifier



Application Circuit PC Board Layout

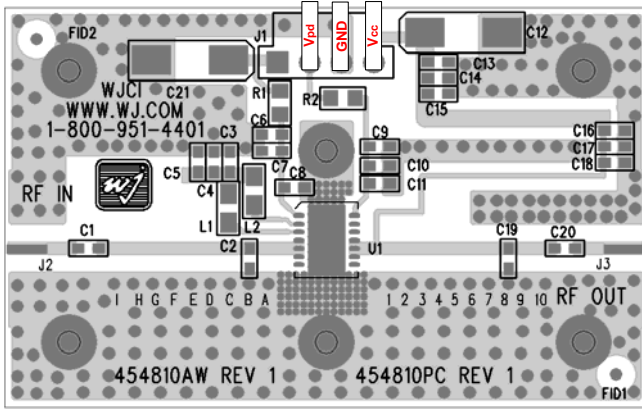

Circuit Board Material: 0.0147" Rogers Ultralam 2000, single layer, 1 oz copper, $\epsilon_r = 2.45$, Microstrip line details: width = .042", spacing = .050"

Baseplate Configuration

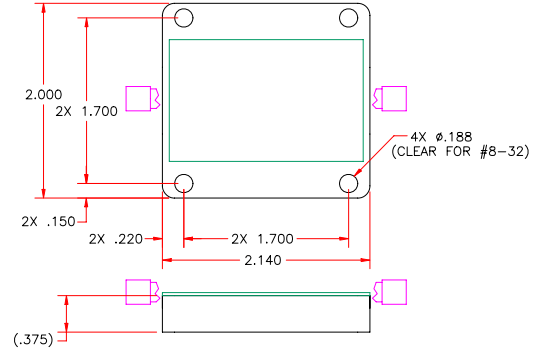

Notes:

1. Please note that for reliable operation, the evaluation board will have to be mounted to a much larger heat sink during operation and in laboratory environments to dissipate the power consumed by the device. The use of a convection fan is also recommended in laboratory environments.
2. The area around the module underneath the PCB should not contain any soldermask in order to maintain good RF grounding.
3. For proper and safe operation in the laboratory, the power-on sequencing is recommended.

Evaluation Board Bias Procedure

Following bias procedure is recommended to ensure proper functionality of AP562 in a laboratory environment. The sequencing is not required in the final system application.

Bias.	Voltage (V)
Vcc	+12
Vpd	+5

Turn-on Sequence:

1. Attach input and output loads onto the evaluation board.
2. Turn on power supply Vcc = +12V.
3. Turn on power supply Vpd = +5V.
4. Turn on RF power.

Turn-off Sequence:

1. Turn off RF power.
2. Turn off power supply Vpd = +5V.
3. Turn off power supply Vcc = +12V.

Typical Device Data

S-Parameters ($V_{CC} = +12\text{ V}$, $I_{CC} = 400\text{ mA}$, $25\text{ }^\circ\text{C}$, unmatched 50 ohm system)

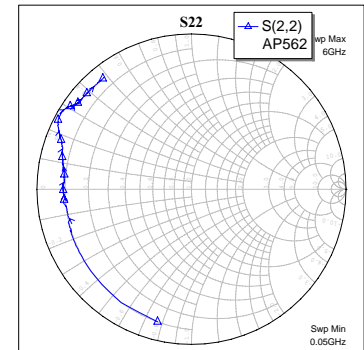
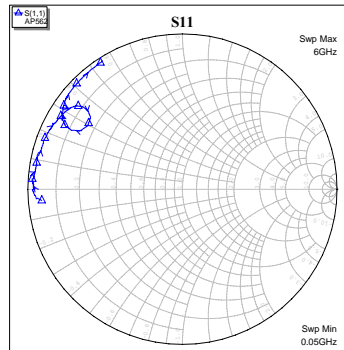
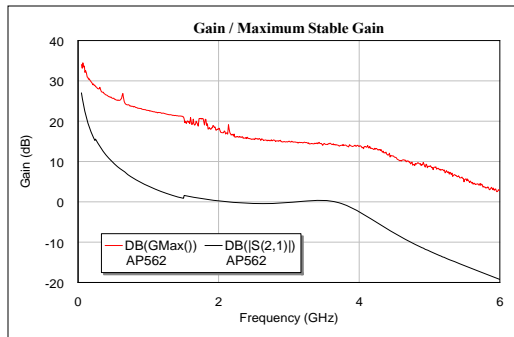

Notes:

The gain for the unmatched device in 50 ohm system is shown as the trace in black color. For a tuned circuit for a particular frequency, it is expected that actual gain will be higher, up to the maximum stable gain. The maximum stable gain is shown in the red line.

S-Parameters ($V_{CC} = +12\text{ V}$, $I_{CC} = 400\text{ mA}$, $25\text{ }^\circ\text{C}$, unmatched 50 ohm system, calibrated to device leads)

Freq (MHz)	S11 (dB)	S11 (ang)	S21 (dB)	S21 (ang)	S12 (dB)	S12 (ang)	S22 (dB)	S22 (ang)
50	-0.79	-175.42	27.05	124.23	-41.01	40.51	-1.10	-104.38
100	-0.40	-177.67	22.28	107.37	-41.94	16.01	-1.53	-137.35
300	-0.31	179.53	14.07	90.92	-41.94	2.09	-1.68	-163.78
500	-0.29	177.89	9.72	82.63	-41.62	0.94	-1.77	-171.20
700	-0.29	175.84	6.87	75.39	-41.31	8.79	-1.81	-175.14
900	-0.34	173.80	4.76	69.22	-41.51	0.79	-1.71	-177.04
1100	-0.36	171.63	3.14	62.91	-41.31	-1.63	-1.63	-178.74
1300	-0.37	168.83	1.85	56.68	-41.31	-5.01	-1.60	179.84
1500	-0.35	165.93	0.86	50.02	-41.31	-8.04	-1.57	178.03
1700	-0.47	161.85	0.96	41.71	-40.35	-13.12	-1.66	174.97
1900	-0.50	158.09	0.45	34.33	-40.35	-18.22	-1.61	172.45
2100	-0.60	154.55	0.05	26.46	-40.18	-24.14	-1.51	170.10
2300	-0.69	150.84	-0.24	17.89	-40.09	-31.86	-1.38	167.43
2500	-0.82	147.61	-0.40	9.26	-39.83	-40.50	-1.28	164.93
2700	-0.94	144.72	-0.44	-0.25	-39.58	-51.10	-1.17	162.74
2900	-1.16	142.23	-0.27	-11.07	-39.33	-65.09	-1.02	160.45
3100	-1.51	140.70	-0.02	-23.54	-38.79	-81.01	-0.81	158.40
3300	-2.02	140.58	0.25	-38.88	-38.06	-102.23	-0.59	156.27
3500	-2.49	142.81	0.36	-58.18	-37.59	-129.91	-0.33	153.91
3700	-2.56	147.66	-0.16	-80.37	-37.20	-160.59	-0.23	150.78
3900	-2.06	151.40	-1.53	-102.11	-37.33	169.42	-0.28	148.13
4100	-1.43	151.78	-3.50	-120.64	-37.79	144.14	-0.40	146.26
4300	-1.01	150.24	-5.66	-135.37	-38.27	122.49	-0.53	145.38
4500	-0.76	148.06	-7.78	-147.04	-38.56	107.83	-0.64	144.44

Device S-parameters are available for download off of the website at: <http://www.tqs.com>

3.4-3.6 GHz Application Circuit (AP562-PCB3500)

Typical O-FDMA Performance at 25°C

Frequency (GHz)	3.4	3.5	3.6	Units
Channel Power	+30	+30	+30	dBm
Power Gain	11.5	11.5	11.3	dB
Input Return Loss	11	15	15	dB
Output Return Loss	5.6	6.7	5.9	dB
EVM	2.2	1.9	1.7	%
Operating Current, I _{cc}	720	685	670	mA
Collector Efficiency	11.1	11.7	12.2	%
Output P _{1dB}	39.5	39.4	38.7	dBm
Quiescent Current, I _{cq}	400			mA
V _{pd}	+5			V
V _{cc}	+12			V

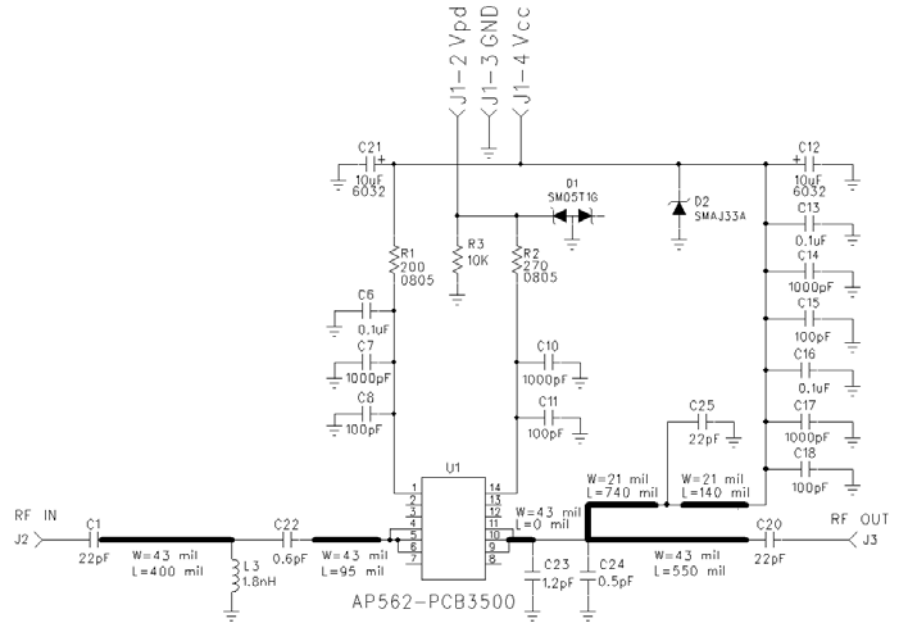
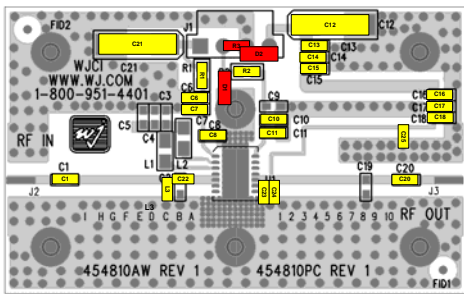

Notes:

The primary RF microstrip line is 50 Ω.
 Components shown on the silkscreen but not on the schematic are not used.

1. The edge of C23 is placed at 43mil from AP562 RFout pin.
2. The edge of C24 is placed right next to C23.
3. The edge of C22 is placed at 95mil from AP562 RFin pin.
4. The edge of L3 is placed right next to C22.

3.4-3.6 GHz Application Circuit Performance Plots

802.16-2004 O-FDMA, 64QAM-1/2, 1024-FFT, 20 symbols and 30 subchannels. 9.5 dB PAR @ 0.01%, 5 MHz Carrier BW

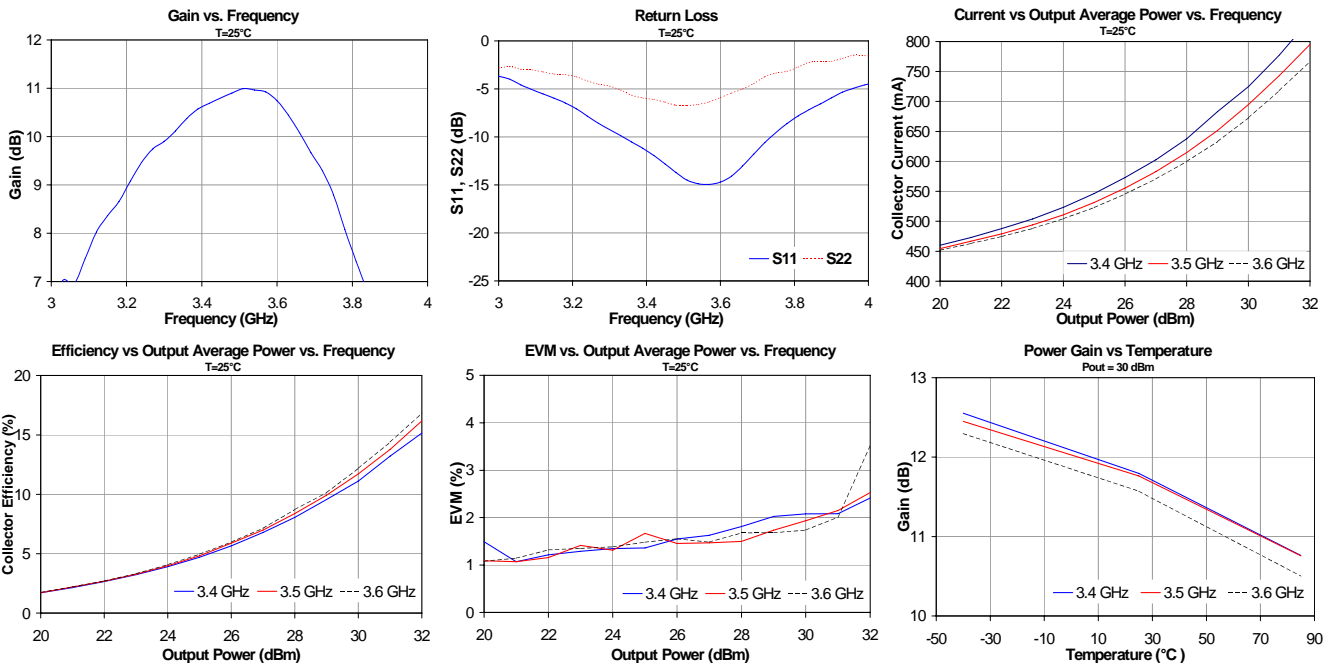

Specifications and information are subject to change without notice

AP562

3.3-3.8 GHz WiMAX 8W Power Amplifier

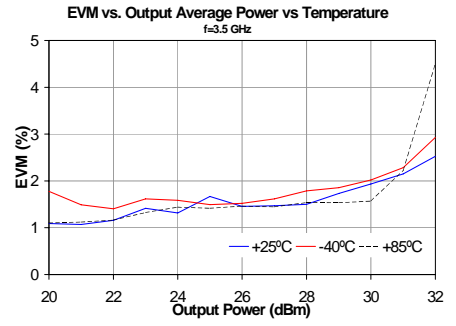
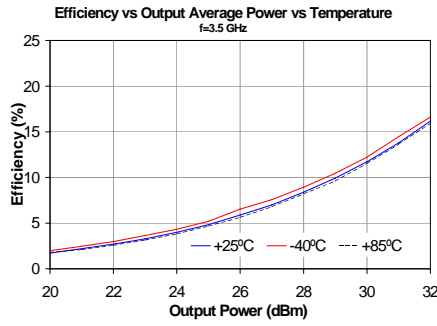
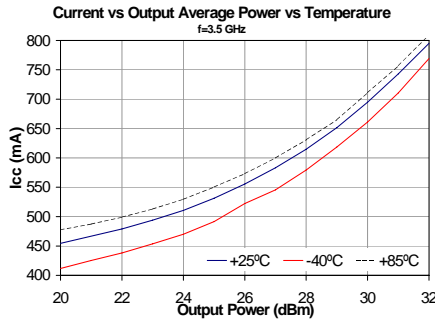

3.4 – 3.6 GHz Application Note: Changing Icq Biasing Configurations

The AP562 can be configured to operate with lower bias current by varying the bias-adjust resistor R2. (Table 1) The recommended circuit configurations shown previously in this datasheet have the device operating with a 400 mA as the quiescent current (I_{CQ}). This biasing level represents a tradeoff in terms of EVM and efficiency. Lowering I_{CQ} will improve upon the efficiency of the device, but degrade the EVM performance. Measured data shown in the plots below represents the AP562 measured and configured for 3.5 GHz applications. It is expected that variation of the bias current for other frequency applications will produce similar performance results.

Table 1 : Reduced Current Operation

I _{cq} (mA)	R ₂ (Ω)	V _{PD} (V)	I _{REF} (V)
400	270	5	2.92
350	275	5	2.88
300	320	5	2.83
250	380	5	2.8
200	473	5	2.73
150	616	5	2.66
100	857	5	2.6

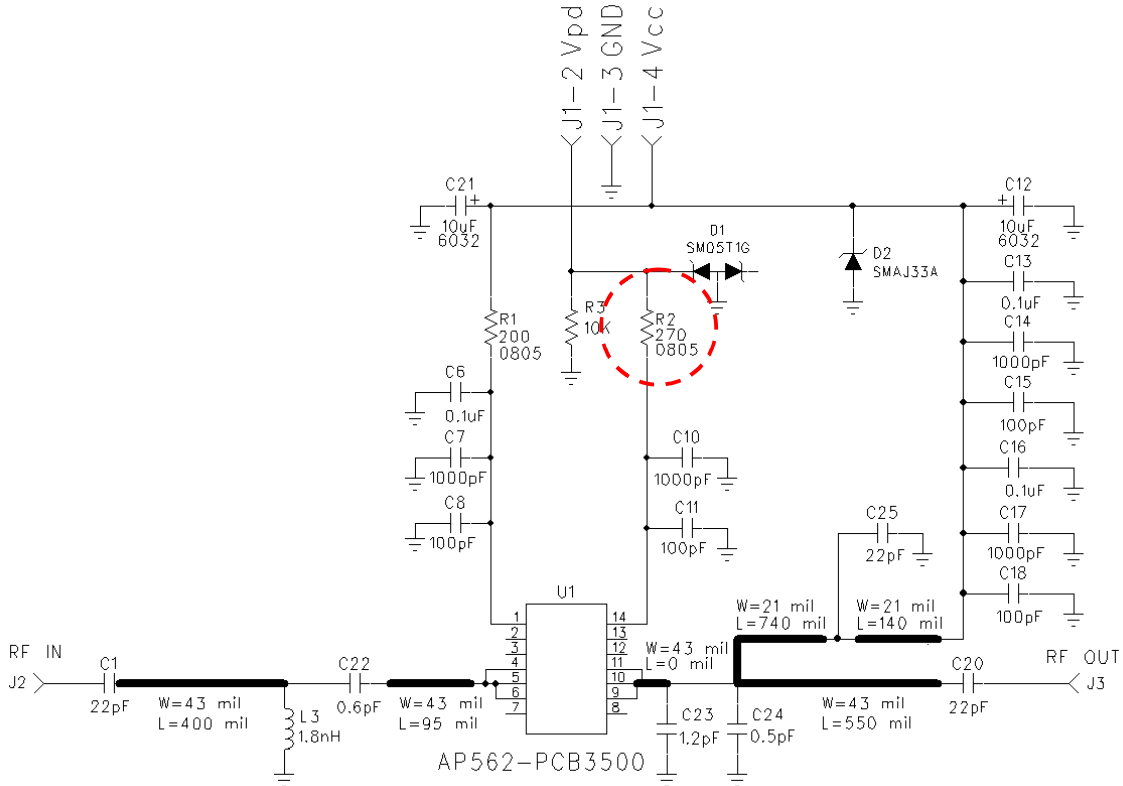
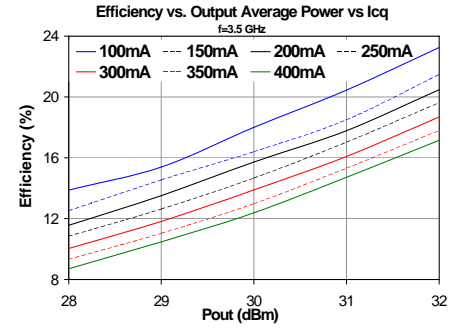
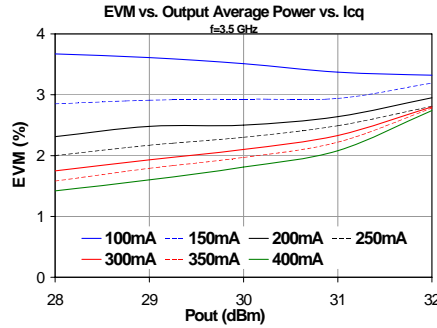

Parameter Measurement Information

Switching Speed Test

Test Conditions:

$V_{cc} = +12V$ at $25^{\circ}C$
 Output Power = $+30dBm$ @ 2.5 GHz
 Rep Rate = 1 KHz, 50% duty cycle
 V_{pd} amplitude = $+5V$
 $R_2 = 200\ \Omega$, $C_9 = 12pF$
 (C_{10} , C_{11} removed for best switching performance)
 Xtal Detector Voltage = $15mV$ (square law)

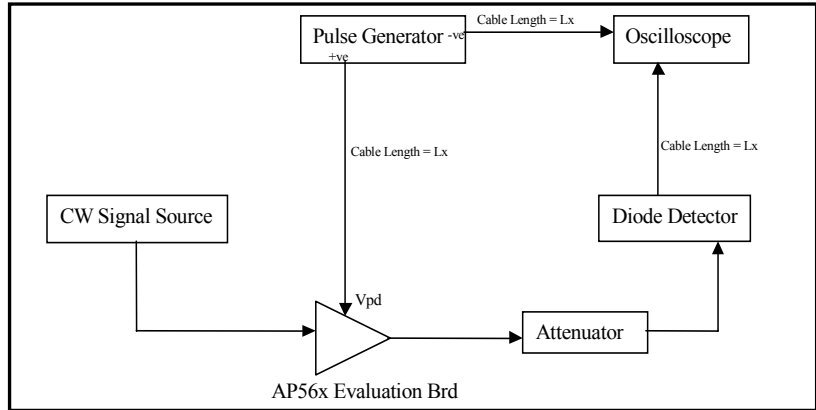

Test Result Waveforms:

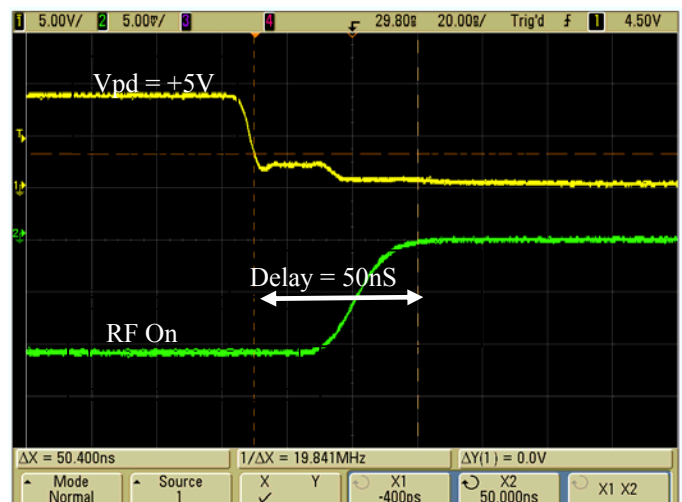
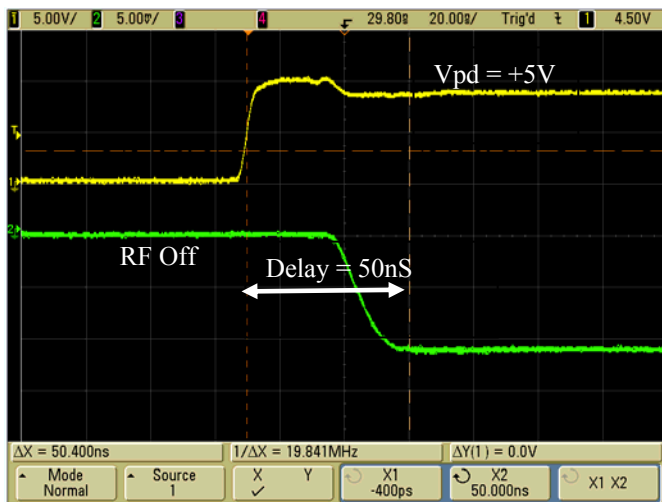
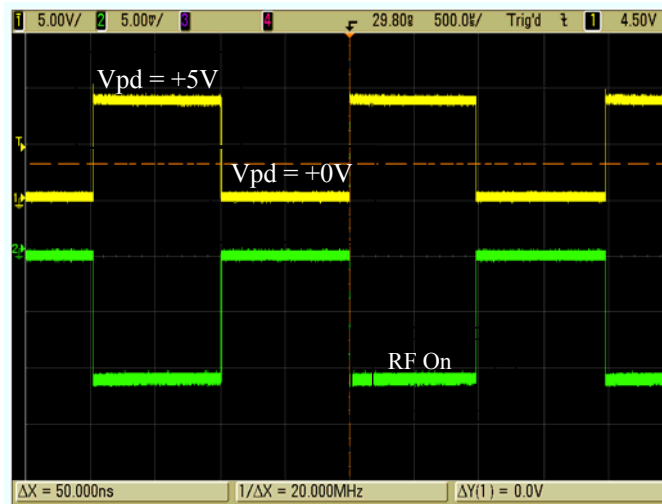

Specifications and information are subject to change without notice

Mechanical Information

This package is lead-free/Green/RoHS-compliant. The plating material on the pins is annealed matte tin over copper. It is compatible with both lead-free (maximum 260 °C reflow temperature) and leaded (maximum 245 °C reflow temperature) soldering processes.

Outline Drawing

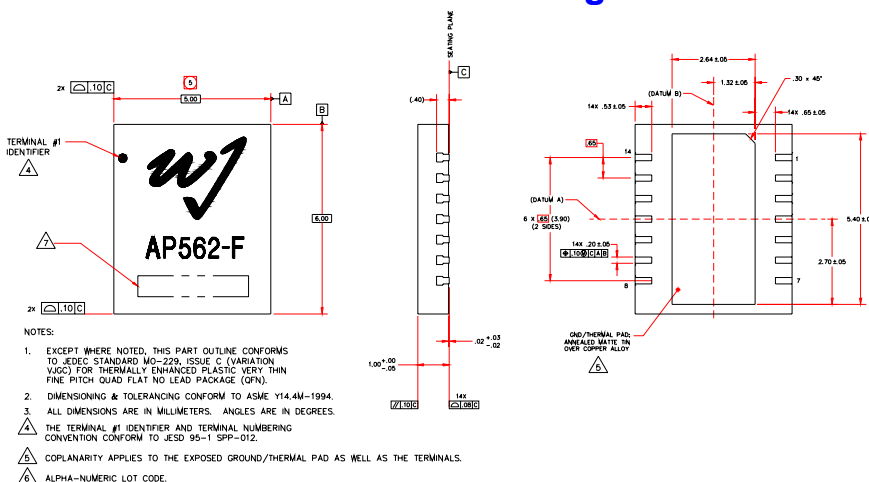

Product Marking

The component will be laser marked with a “AP562-F” product label with an alphanumeric lot code on the top surface of the package.

Tape and reel specifications for this part will be located on the website in the “Application Notes” section.

Functional Pin Layout

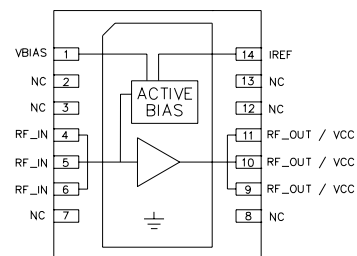

Pin	Function
1	VBIAS
2, 3, 7, 8, 12, 13	N/C
4, 5, 6	RF IN
9, 10, 11	RF Output / Vcc
14	IREF
Backside paddle	GND

Mounting Configuration / Land Pattern

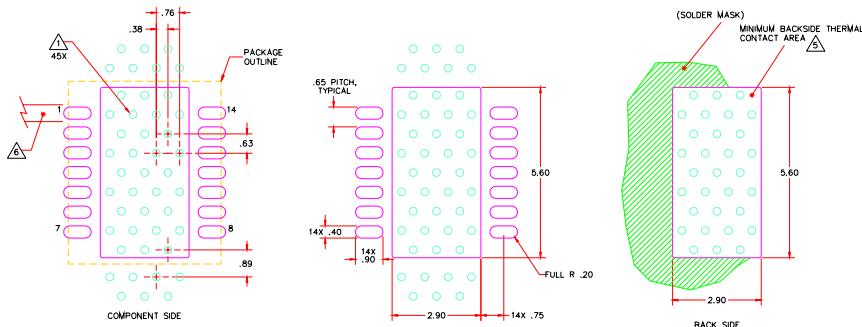

- NOTES:**
- GROUND/THERMAL VIAS ARE CRITICAL FOR THE PROPER PERFORMANCE OF THIS DEVICE. VIAS SHOULD USE A .35mm (#80/.0135") DIAMETER DRILL AND HAVE A FINAL PLATED THRU DIAMETER OF .25mm (.010").
 - ADD AS MUCH COPPER AS POSSIBLE TO INNER AND OUTER LAYERS NEAR THE PART TO ENSURE OPTIMAL THERMAL PERFORMANCE.
 - TO ENSURE RELIABLE OPERATION, DEVICE GROUND PADDLE-TO-GROUND PAD SOLDER JOINT IS CRITICAL.
 - ADD MOUNTING SCREWS NEAR THE PART TO FASTEN THE BOARD TO A HEATSINK. ENSURE THAT THE GROUND/THERMAL VIA REGION CONTACTS THE HEATSINK.
 - DO NOT PUT SOLDER MASK ON THE BACK SIDE OF THE PCB BOARD IN THE REGION WHERE THE BOARD CONTACTS THE HEATSINK.
 - RF TRACE WIDTH DEPENDS UPON THE PCB BOARD MATERIAL AND CONSTRUCTION.
 - USE 1 OZ. COPPER MINIMUM.
 - ALL DIMENSIONS ARE IN MILLIMETERS. ANGLES ARE IN DEGREES.
 - A HEATSINK UNDERNEATH THE AREA OF THE PCB FOR THE MOUNTED DEVICE IS STRICTLY REQUIRED FOR PROPER THERMAL OPERATION. DAMAGE TO THE DEVICE CAN OCCUR WITHOUT THE USE OF ONE.

MSL / ESD Rating



Caution! ESD sensitive device.

ESD Rating: Class 1A
 Value: Passes $\geq 250V$ to $<500V$
 Test: Human Body Model (HBM)
 Standard: JEDEC Standard JESD22-A114

ESD Rating: Class IV
 Value: Passes $\geq 1000V$ to $<2000V$
 Test: Charged Device Model (CDM)
 Standard: JEDEC Standard JESD22-C101

MSL Rating: Level 3 at $+260\text{ }^{\circ}\text{C}$ convection reflow
 Standard: JEDEC Standard J-STD-020