

## Product Features

- DC – 5.5 GHz
- 15 dB Gain @ 1 GHz
- +15.5 dBm P1dB @ 1 GHz
- +32 dBm OIP3 @ 1 GHz
- 3.7 dB Noise Figure
- Internally matched to 50 Ω
- Robust 1000V ESD, Class 1C
- Lead-free/green/RoHS-compliant SOT-86, SOT-363 & SOT-89 Package

## Applications

- Mobile Infrastructure
- CATV / FTTX
- WLAN / ISM
- RFID
- WiMAX / WiBro

## Product Description

The ECG006 is a general-purpose buffer amplifier that offers high dynamic range in a low-cost surface-mount package. At 1000 MHz, the ECG006 typically provides 15 dB of gain, +32 dBm Output IP3, and +15.5 dBm P1dB.

The ECG006 consists of a Darlington-pair amplifier using the high reliability InGaP/GaAs HBT process technology and only requires DC-blocking capacitors, a bias resistor, and an inductive RF choke for operation. The device is ideal for wireless applications and is available in low-cost, surface-mountable plastic lead-free/green/RoHS-compliant SOT-363, SOT-86 and SOT-89 packages. All devices are 100% RF and DC tested.

The broadband MMIC amplifier can be directly applied to various current and next generation wireless technologies such as GPRS, GSM, CDMA, and W-CDMA. In addition, the ECG006 will work for other various applications within the DC to 5.5 GHz frequency range such as CATV and mobile wireless.

## Functional Diagram

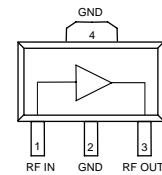

**ECG006B-G**

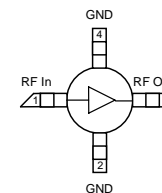

**ECG006C-G**

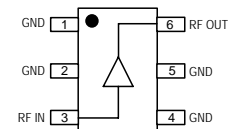

**ECG006F-G**

## Specifications <sup>(1)</sup>

Parameter	Units	Min	Typ	Max
Operational Bandwidth	MHz	DC		5500
Test Frequency	MHz		1000	
Gain	dB		15	
Output P1dB	dBm		+15.4	
Output IP3 <sup>(2)</sup>	dBm		+32	
Test Frequency	MHz		2000	
Gain	dB	12	14	18
Input Return Loss	dB		18	
Output Return Loss	dB		14	
Output P1dB	dBm	+12	+15	
Output IP3 <sup>(2)</sup>	dBm		+32	
Noise Figure	dB		4.0	
Device Voltage	V	3.5	3.9	4.3
Device Current	mA		45	

1. Test conditions unless otherwise noted: 25°C, Supply Voltage = +5 V, Rbias = 24.3 Ω, 50 Ω System.  
 2. 3OIP measured with two tones at an output power of +2 dBm/tone separated by 1 MHz. The suppression on the largest IM3 product is used to calculate the 3OIP using a 2:1 rule.

## Absolute Maximum Rating

Parameter	Rating
Storage Temperature	-55 to +150 °C
Device Current	150 mA
RF Input Power (continuous)	+12 dBm
Thermal Resistance - ECG006B-G	131 °C/W
Thermal Resistance - ECG006C-G	233 °C/W
Thermal Resistance - ECG006F-G	233 °C/W
Junction Temperature	+160 °C

Operation of this device above any of these parameters may cause permanent damage.

## Typical Performance <sup>(1)</sup>

Parameter	Units	Typical			
Frequency	MHz	500	900	1900	2140
S21	dB	15.5	15	14.2	14
S11	dB	-20	-14	-17.4	-18
S22	dB	-16	-13	-14.5	-15
Output P1dB	dBm	+15.8	+15.4	+15	+15
Output IP3 <sup>(2)</sup>	dBm	+32	+32	+30	+30
Noise Figure	dB	3.7	3.7	3.7	3.7

## Ordering Information

Part No.	Description
ECG006B-G	InGaP HBT Gain Block (lead-free/green/RoHS-compliant SOT-89 package)
ECG006C-G	InGaP HBT Gain Block (lead-free/green/RoHS-compliant SOT-86 package)
ECG006F-G	InGaP HBT Gain Block (lead-free/green/RoHS-compliant SOT-363 package)
ECG006B-PCB	700 – 2400 MHz Fully Assembled Eval. Board
ECG006C-PCB	700 – 2400 MHz Fully Assembled Eval. Board
ECG006F-PCB	700 – 2400 MHz Fully Assembled Eval. Board

Standard tape / reel size = 1000 pieces on a 7" reel for ECG006B-G

Standard tape / reel size = 1000 pieces on a 7" reel for ECG006C-G

Standard tape / reel size = 3000 pieces on a 7" reel for ECG006F-G

Specifications and information are subject to change without notice

**Typical Device RF Performance**  
Supply Bias = +5 V,  $R_{bias} = 24.3 \Omega$ ,  $I_{cc} = 45 \text{ mA}$

Frequency	MHz	100	500	900	1900	2140	2400	3500	5800
S21	dB	15.3	15.2	15.1	14.5	14.3	14.1	13.9	10.2
S11	dB	-20	-18	-14	-17	-18	-20	-17	-12.5
S22	dB	-29	-16	-13	-14	-14	-15	-15	-9.5
Output P1dB	dBm	+15.8	+15.4	+15.2	+15.0	+14.9	+14.6	+14	
Output IP3	dBm	+31	+31.5	+32	+30	+30	+29.6		
Noise Figure	dB	3.8	3.7	3.6	3.6	3.6	3.6		

1. Test conditions: T = 25° C, Supply Voltage = +5 V, Device Voltage = +3.9 V,  $R_{bias} = 24.3 \Omega$ ,  $I_{cc} = 45 \text{ mA}$  typical, 50  $\Omega$  System.
2. 3OIP measured with two tones at an output power of +2 dBm/tone separated by 1 MHz. The suppression on the largest IM3 product is used to calculate the 3OIP using a 2:1 rule.
3. Data is shown as device performance only. Actual implementation for the desired frequency band will be determined by external components shown in the application circuit.

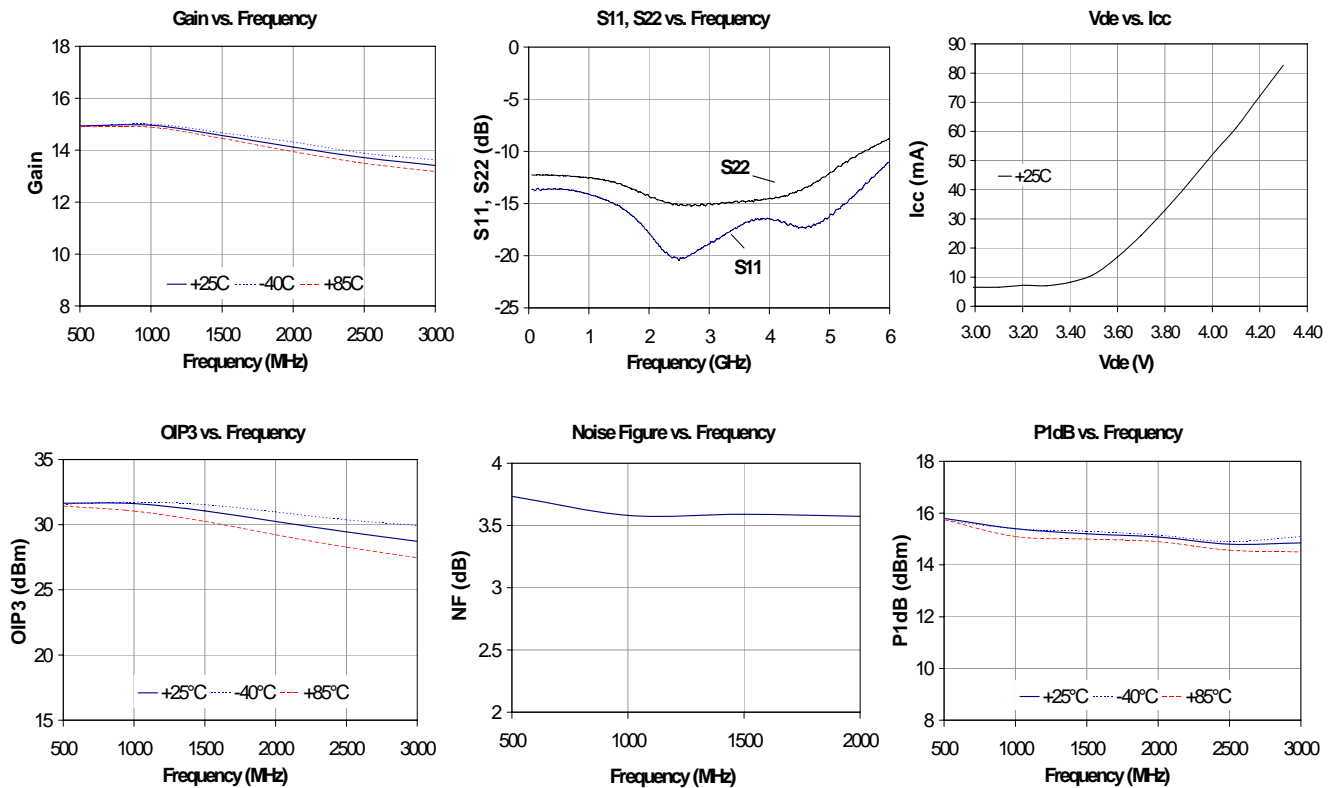

**Recommended Application Circuit**

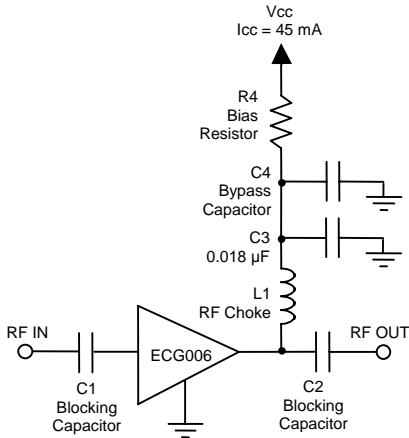

**ECG006C-PCB**

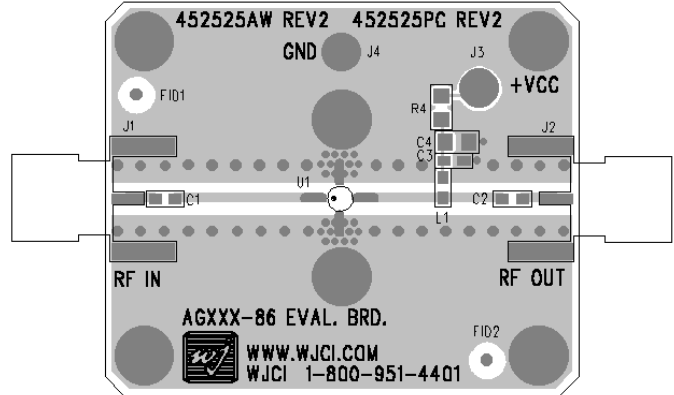

**ECG006B-PCB**

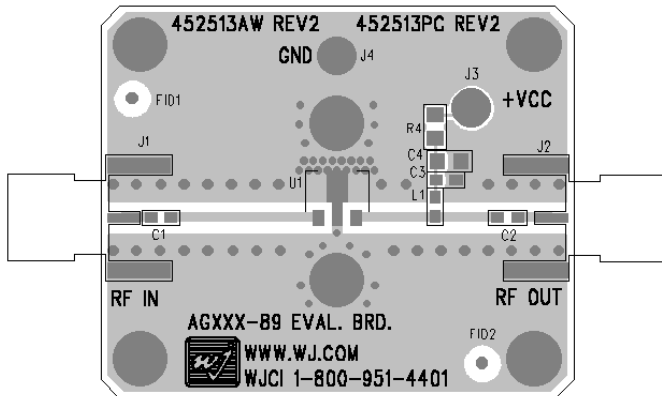

**ECG006F-PCB**

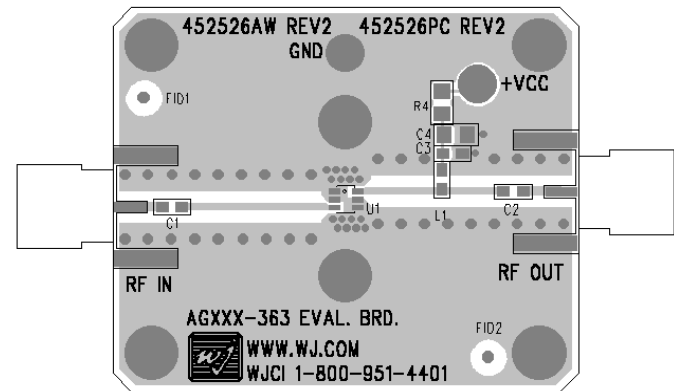

**Recommended Component Values**

Reference Designator	Frequency (MHz)						
	50	500	900	1900	2200	2500	3500
L1	820 nH	220 nH	68 nH	27 nH	22 nH	18 nH	15 nH
C1, C2, C4	.018 µF	1000 pF	100 pF	68 pF	68 pF	56 pF	39 pF

1. The proper values for the components are dependent upon the intended frequency of operation.
2. The following values are contained on the evaluation board to achieve optimal broadband performance:

Ref. Desig.	Value / Type	Size
L1	39 nH wirewound inductor	0603
C1, C2	56 pF chip capacitor	0603
C3	0.018 µF chip capacitor	0603
C4	Do Not Place	
R4	24.3Ω 1% tolerance	0805

**Recommended Bias Resistor Values**

Supply Voltage	R1 value	Size
5 V	24.4 ohms	0805
6 V	46.7 ohms	0805
8 V	91 ohms	1210
9 V	113 ohms	1210
10 V	136 ohms	2010
12 V	180 ohms	2010

The proper value for R1 is dependent upon the supply voltage and allows for bias stability over temperature. WJ recommends a minimum supply bias of +5 V. A 1% tolerance resistor is recommended.



## ECG006C-G Mechanical Information

This package is lead-free/Green/RoHS-compliant. The plating material on the pins is annealed matte tin over copper. It is compatible with both lead-free (maximum 260 °C reflow temperature) and leaded (maximum 245 °C reflow temperature) soldering processes.

### Outline Drawing

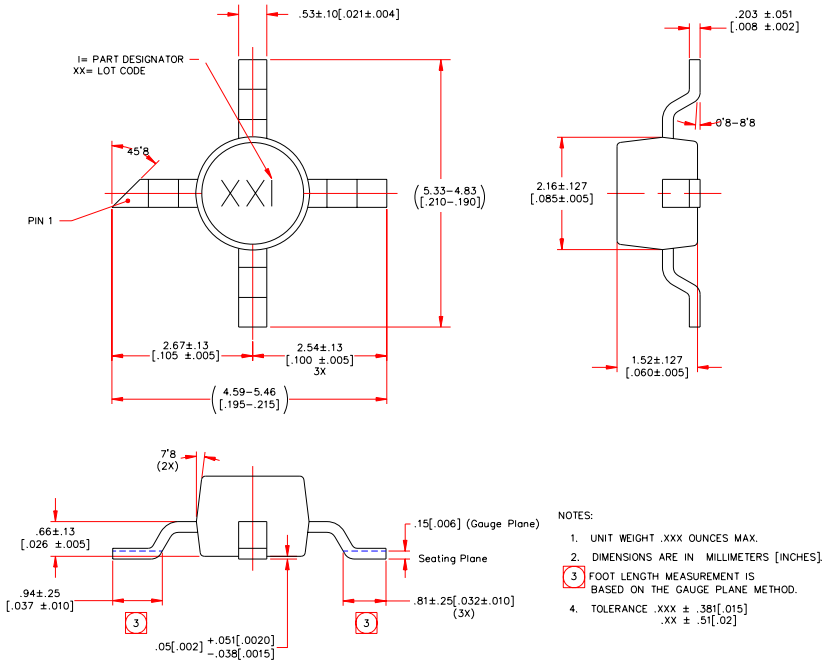

### Product Marking

The component will be marked with a two-digit numeric lot code (shown as "XX") followed with an "I" designator on the top surface of the package. The obsolete tin-lead package is marked with a two-digit numeric lot code followed with a "N" designator; it may also have been marked with a "N" designator followed by a two-digit lot code.

Tape and reel specifications for this part are located on the website in the "Application Notes" section.

### MSL / ESD Rating



Caution! ESD sensitive device.

ESD Rating: Class 1A  
 Value: Passes between 250 and 500V  
 Test: Human Body Model (HBM)  
 Standard: JEDEC Standard JESD22-A114

MSL Rating: Level 3 at +260 °C convection reflow  
 Standard: JEDEC Standard J-STD-020

### Land Pattern

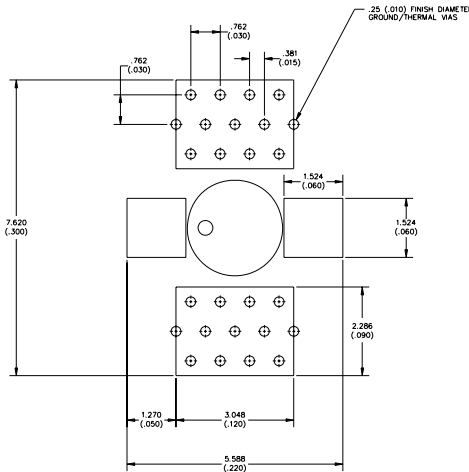

### Mounting Config. Notes

1. Ground / thermal vias are critical for the proper performance of this device. Vias should use a .35mm (#80 / .0135") diameter drill and have a final plated thru diameter of .25 mm (.010").
2. Add as much copper as possible to inner and outer layers near the part to ensure optimal thermal performance.
3. Mounting screws can be added near the part to fasten the board to a heatsink. Ensure that the ground / thermal via region contacts the heatsink.
4. Do not put solder mask on the backside of the PC board in the region where the board contacts the heatsink.
5. RF trace width depends upon the PC board material and construction.
6. Use 1 oz. Copper minimum.
7. All dimensions are in millimeters (inches). Angles are in degrees.

## ECG006F-G Mechanical Information

This package is lead-free/Green/RoHS-compliant. The plating material on the leads is annealed matte tin over copper. It is compatible with both lead-free (maximum 260 °C reflow temperature) and leaded (maximum 245 °C reflow temperature) soldering processes.

### Outline Drawing

SYMBOL	MIN	MAX
A	0.80 (.031)	1.30 (.047)
A1	0.25 (.010)	0.066 (.004)
A2	0.80 (.031)	1.05 (.041)
D	1.80 (.071)	2.20 (.087)
E	1.80 (.071)	2.40 (.094)
E1	1.15 (.045)	1.35 (.053)
L	0.15 (.004)	0.30 (.012)
L1	2.75 (.101)	3.75 (.148)
L2	0.09 (.004)	0.18 (.007)
b	0.15 (.006)	0.40 (.016)
c	.09 (.004)	.18 (.007)
e	.65 BASIC (.026)	
e1	1.30 BASIC (.051)	

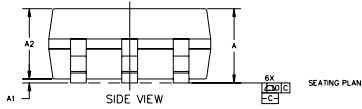
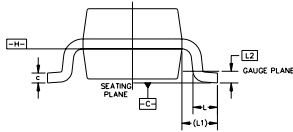
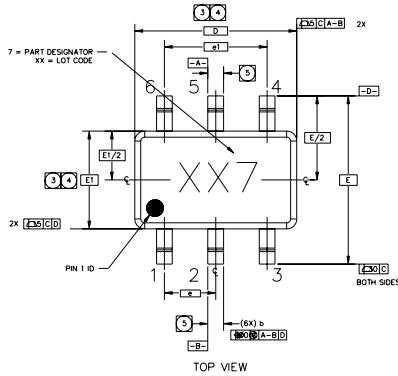

**NOTES:**

- DIMENSIONS AND TOLERANCING PER ASME Y14.5M-1194. PACKAGE CONFORMS TO JEDEC MO-203, ISSUE B.
- DIMENSIONS ARE IN MILLIMETERS (INCHES).
- DIMENSION D DOES NOT INCLUDE MOLD FLASH, PROTRUSIONS OR GATE BURRS. MOLD FLASH, PROTRUSIONS OR GATE BURRS SHALL NOT EXCEED 0.15 mm PER END. DIMENSION E1 DOES NOT INCLUDE INTERLEAD FLASH OR PROTRUSION. INTERLEAD FLASH OR PROTRUSION SHALL NOT EXCEED 0.15 mm PER SIDE. D AND E1 DIMENSIONS ARE DETERMINED AT DATUM H.
- THE PACKAGE TOP MAY BE SMALLER THAN THE PACKAGE BOTTOM. DIMENSIONS D AND E1 ARE DETERMINED AT THE OUTERMOST EXTREMES OF THE PLASTIC BODY EXCLUSIVE OF MOLD FLASH, GATE BURRS, GATE BURRS AND INTERLEAD FLASH, BUT INCLUDING ANY MISMATCH BETWEEN THE TOP AND THE BOTTOM OF THE PLASTIC BODY. D AND E1 DIMENSIONS ARE DETERMINED AT DATUM H.
- DATUM A & B TO BE DETERMINED AT DATUM H.
- DIMENSION 'b' DOES NOT INCLUDE DAMBAR PROTRUSION. ALLOWABLE DAMBAR PROTRUSION SHALL BE 0.08 mm TOTAL IN EXCESS OF THE 'b' DIMENSION AT MAXIMUM MATERIAL CONDITION. THE DAMBAR IS NOT LOCATED ON THE LOWER RADIUS OF THE FOOT. MINIMUM SPACE BETWEEN PROTRUSION AND AN ADJACENT LEAD SHALL NOT BE LESS THAN 0.07 mm.

### Land Pattern

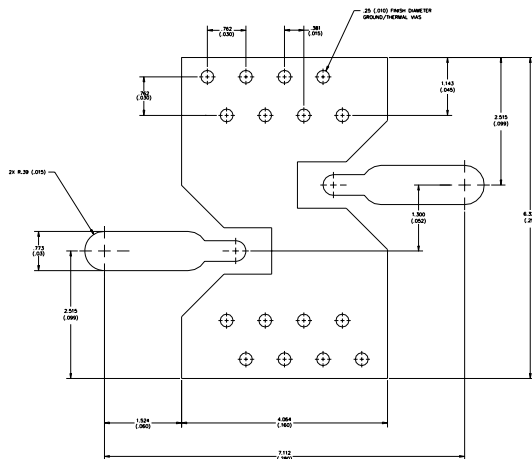

### Product Marking

The component will be marked with a two-digit numeric lot code (shown as "XX") followed with a "7" designator on the top surface of the package. The obsolete tin-lead package is marked with a two-digit numeric lot code followed with a "3" designator; it may also have been marked with a "30" designator followed by a letter lot code.

Tape and reel specifications for this part are located on the website in the "Application Notes" section.

### MSL / ESD Rating



**Caution!** ESD sensitive device.

ESD Rating: Class 1A  
Value: Passes between 250 and 500V  
Test: Human Body Model (HBM)  
Standard: JEDEC Standard JESD22-A114

MSL Rating: Level 3 at +260 °C convection reflow  
Standard: JEDEC Standard J-STD-020

### Mounting Config. Notes

- Ground / thermal vias are critical for the proper performance of this device. Vias should use a .35mm (#80 / .0135") diameter drill and have a final plated thru diameter of .25mm (.010").
- Add as much copper as possible to inner and outer layers near the part to ensure optimal thermal performance.
- Mounting screws can be added near the part to fasten the board to a heatsink. Ensure that the ground / thermal via region contacts the heatsink.
- Do not put solder mask on the backside of the PC board in the region where the board contacts the heatsink.
- RF trace width depends upon the PC board material and construction.
- Use 1 oz. Copper minimum.
- All dimensions are in millimeters (inches). Angles are in degrees.

## Typical Device S-Parameters – ECG006B-G

S-Parameters ( $V_{\text{device}} = +3.9 \text{ V}$ ,  $I_{\text{CC}} = 45 \text{ mA}$ ,  $T = 25^\circ\text{C}$ , calibrated to device leads)

Freq (MHz)	S11 (dB)	S11 (ang)	S21 (dB)	S21 (ang)	S12 (dB)	S12 (ang)	S22 (dB)	S22 (ang)
50	-16.18	-2.18	15.76	178.02	-18.89	-0.38	-14.36	-2.29
500	-16.13	-22.13	15.57	160.12	-18.77	-2.87	-14.40	-26.41
1000	-15.97	-44.58	15.21	141.76	-18.46	-5.33	-14.15	-51.57
1500	-15.79	-68.38	14.80	124.56	-17.94	-9.45	-13.78	-77.30
2000	-15.34	-96.24	14.57	108.50	-17.29	-14.37	-13.23	-104.15
2500	-14.99	-124.42	14.34	91.11	-16.69	-21.48	-12.79	-131.75
3000	-14.73	-153.90	14.02	74.20	-16.16	-29.16	-12.22	-160.58
3500	-14.29	174.59	13.65	56.77	-15.76	-38.37	-11.63	170.65
4000	-13.38	141.41	13.22	39.56	-15.49	-47.75	-10.44	143.61
4500	-11.80	110.87	12.66	22.19	-15.29	-57.59	-9.04	117.68
5000	-9.66	85.53	12.00	5.48	-15.28	-68.56	-7.50	96.34
5500	-7.85	63.77	11.20	-10.89	-15.43	-79.10	-6.12	76.71
6000	-6.37	47.01	10.36	-26.75	-15.69	-89.87	-4.95	59.58

## Typical Device S-Parameters – ECG006C-F

S-Parameters ( $V_{\text{device}} = +3.9 \text{ V}$ ,  $I_{\text{CC}} = 45 \text{ mA}$ ,  $T = 25^\circ\text{C}$ , calibrated to device leads)

Freq (MHz)	S11 (dB)	S11 (ang)	S21 (dB)	S21 (ang)	S12 (dB)	S12 (ang)	S22 (dB)	S22 (ang)
50	-13.66	-1.22	15.30	178.47	-18.67	-0.33	-12.25	-1.92
500	-13.64	-13.39	15.23	164.32	-18.59	0.29	-12.33	-20.62
1000	-14.11	-23.99	15.01	149.00	-18.38	0.78	-12.52	-41.41
1500	-15.20	-35.45	14.72	134.06	-17.99	0.29	-13.08	-62.51
2000	-17.86	-52.47	14.44	119.89	-17.52	-0.93	-14.31	-82.78
2500	-20.46	-93.43	14.06	105.18	-17.12	-3.33	-15.20	-99.71
3000	-18.86	-135.97	13.53	91.27	-16.59	-6.24	-15.01	-124.98
3500	-17.20	-158.47	12.99	77.75	-16.21	-10.91	-14.89	-157.99
4000	-16.45	-171.80	12.38	65.03	-15.93	-15.16	-14.50	170.24
4500	-17.31	166.84	11.76	52.68	-15.73	-19.74	-13.75	147.52
5000	-16.22	136.42	11.25	40.65	-15.52	-24.35	-12.08	133.59
5500	-13.68	110.91	10.56	28.09	-15.42	-29.98	-10.21	119.31
6000	-11.01	97.79	9.95	17.28	-15.43	-34.96	-8.73	106.39

## Typical Device S-Parameters – ECG006F-G

S-Parameters ( $V_{\text{device}} = +3.9 \text{ V}$ ,  $I_{\text{CC}} = 45 \text{ mA}$ ,  $T = 25^\circ\text{C}$ , calibrated to device leads)

Freq (MHz)	S11 (dB)	S11 (ang)	S21 (dB)	S21 (ang)	S12 (dB)	S12 (ang)	S22 (dB)	S22 (ang)
50	-16.22	-0.52	15.76	178.32	-18.82	-0.82	-14.16	-2.06
500	-14.87	-18.97	15.63	165.77	-18.87	1.49	-12.83	-24.91
1000	-16.45	-51.46	15.51	151.31	-18.40	1.44	-14.19	-55.98
1500	-16.41	-95.69	15.22	137.15	-18.07	0.35	-14.59	-93.37
2000	-14.08	-118.65	14.79	123.39	-17.74	-1.31	-13.52	-120.99
2500	-12.50	-114.48	14.48	112.93	-17.16	-2.57	-13.05	-122.53
3000	-12.18	-126.96	14.14	100.74	-16.80	-4.49	-12.19	-138.80
3500	-11.70	-139.53	13.94	88.52	-16.16	-8.66	-11.93	-159.41
4000	-10.97	-158.51	13.57	75.28	-15.72	-12.48	-11.00	174.63
4500	-10.24	178.62	13.03	62.14	-15.50	-19.07	-9.10	151.63
5000	-9.06	161.58	12.33	51.12	-15.19	-24.71	-7.50	139.14
5500	-8.32	150.77	11.60	42.08	-15.22	-28.00	-6.87	136.14
6000	-7.84	140.56	10.95	33.72	-15.14	-30.97	-6.78	137.51

Device S-parameters are available for download from the website at: <http://www.wj.com>