

## Product Features

- 150 – 3000 MHz
- +44 dBm OIP3  
(balanced configuration)
- +48 dBm OIP3  
(dual push-pull configuration)
- Single-ended performance:
  - 13.5 dB Gain
  - 2.7 dB Noise Figure
  - +21 dBm P1dB
- Single +5 Volt Supply
- Lead-free/green/RoHS-compliant SOIC-8 package

## Applications

- Mobile Infrastructure
- Defense / Homeland Security
- Fixed Wireless

## Product Description

The AH11 is a high linearity amplifier for use in digital communication systems. It combines low noise figure and high intercept point into a low-cost SMT solution. This device extends the linear efficiency advantages of WJ's AH1 to higher power levels by combining two internally matched die. This dual-amplifier configuration allows for the optimal design of balanced or push-pull operation. The amplifier can also be used for single-ended operation in each branch of a diversity receive system.

A mature and reliable GaAs MESFET technology is employed to maximize linearity while achieving low noise figure. The package is a thermally enhanced lead-free/green/RoHS-compliant SOIC-8 package thus allowing the device to achieve an MTTF greater than 100 years at a case temperature of 85 °C. All devices are 100% RF and DC tested.

## Functional Diagram

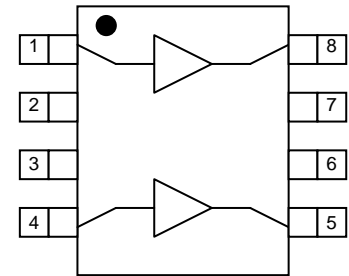

Function	Pin No.
Input (Amp 1)	1
Ground	2, 3, 6, 7, Bottom Slug
Input (Amp 2)	4
Output (Amp 1)	5
Output (Amp 2)	8

## Specifications <sup>(1)</sup> (Single-ended Performance)

Parameter	Units	Min	Typ	Max
Test Frequency	MHz		800	
Gain	dB	12.4	13.5	
Input Return Loss <sup>(2)</sup>	dB		8	
Output Return Loss	dB		15	
Output IP3 <sup>(3)</sup>	dBm	+37	+41	
Output P1dB	dBm		+21	
Noise Figure	dB		2.7	
Operating Current Range	mA	120	150	180
Supply Voltage	V		+5	

1. Test conditions unless otherwise noted: T = 25 °C, Supply Voltage = +5 V, Frequency = 800 MHz, 50 Ω System, tested on each single-ended amplifier (there are two amplifiers in an AH11 package)
2. S21 and S11 can be improved in the band of interest with some slight input tuning.
3. 3OIP measured with two tones at an output power of +5 dBm/tone separated by 10 MHz. The suppression on the largest IM3 product is used to calculate the 3OIP using a 2:1 rule. Slight OIP3 degradation of about 2 dB is expected to occur at lower temperatures (from 25 °C to -40 °C).

## Typical Performance (Balanced Configuration)

Parameter	Units	Typical		
Frequency	MHz	900	1900	2100
S21	dB	12.2	11.2	10.6
S11	dB	-10	-14	-10
S22	dB	-18	-10	-10
Output IP3	dBm	+46	+44	+45
Noise Figure	dB	4.1	4.2	5.6
Supply Bias		+5 V @ 300 mA		

Test conditions: T = 25 °C, in a tuned application circuit (shown on page 2)

## Typical Performance (Dual P-P Configuration)

Parameter	Units	Typical	
Frequency	MHz	900	1900
S21	dB	13.4	11.9
S11	dB	-19	-19
S22	dB	-12	-10
Output IP3	dBm	+48	+48
Noise Figure	dB	3.4	3.7
Supply bias		+5 V @ 600 mA	

Test conditions: T = 25 °C, in a tuned application circuit (shown on pages 3 and 4)

## Absolute Maximum Rating

Parameter	Rating
Storage Temperature	-55 to +125 °C
Supply Voltage	+6 V
RF Input Power (continuous)	4 dB above Input P1dB
Thermal Resistance, Rth	29°C/W
Junction Temperature	+160°C

Operation of this device above any of these parameters may cause permanent damage.

## Ordering Information

Part No.	Description
AH11-G	High Dynamic Range CATV Amplifier (lead-free/green/RoHS-compliant SOIC-8 Package)
AH11BAL-PCB	0.6-2.1GHz Eval Board, Balanced Configuration
AH11PP900-PCB	0.9GHz Eval Board, Dual Push-Pull Configuration
AH11PP1900-PCB	1.9GHz Eval Board, Dual Push-Pull Configuration

Standard tape / reel size = 500 pieces on a 7" reel

Specifications and information are subject to change without notice

## Balanced Circuit: 600 – 2100 MHz

Typical Performance (50 Ohm System)

Frequency	600 MHz	900 MHz	1900 MHz	2100 MHz
Magnitude S21	10.7 dB	12.2 dB	11.2 dB	10.6 dB
Magnitude S11	-10.0 dB	-10.0 dB	-13.5 dB	-10.0 dB
Magnitude S22	-12.7 dB	-18.2 dB	-10.0 dB	-10.0 dB
NF	7.62 dB	4.13 dB	4.16 dB	5.55 dB
OIP2	63 dBm	65 dBm	65 dBm	63 dBm
OIP3	42 dBm	46 dBm	44 dBm	45 dBm
Bias	Vds = 5.0 V, Id = 300 mA			

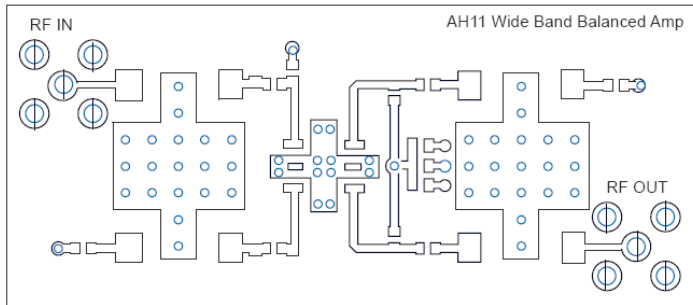
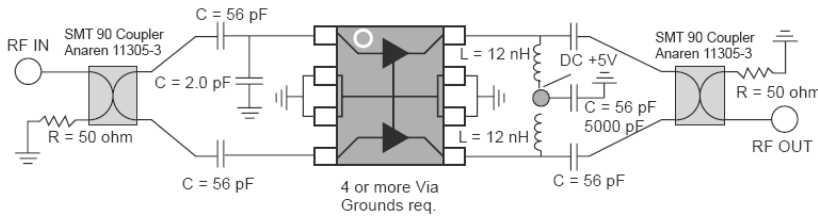

### Parts List

QTY	Description	Size	MFR	Part No.
1	Hi pwr Linear Amp	SOIC8	WJ	AH11
2	90 Coupler Wideband		Anaren	11305-3
5	56 pF Capacitor	0603	Kemet	
1	5000 pF Capacitor	0603	Kemet	
1	0.1 uF Capacitor	0805	Kemet	
2	12 nH Inductor	0603	Toko	
1	2.0 pF Capacitor	0603	Kemet	
4	100 ohm Resistor	0603		

## Performance Charts

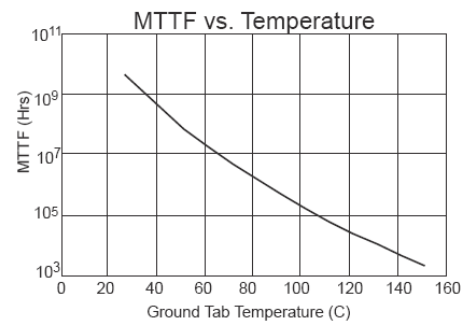
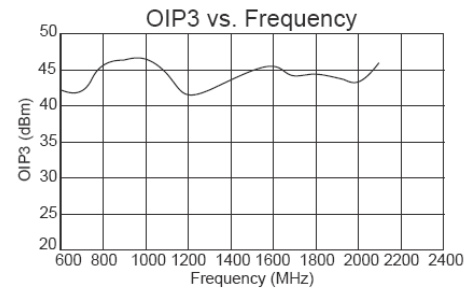
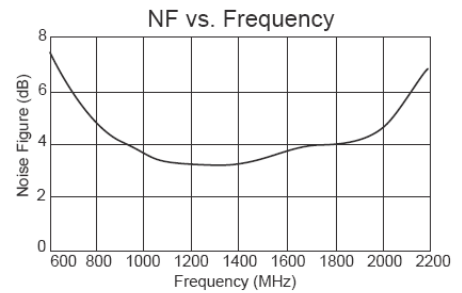
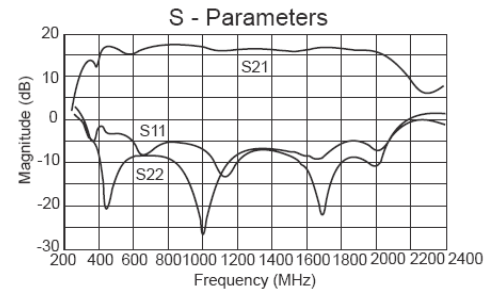



# AH11

## High Dynamic Range Dual Amplifier



### Dual Push-Pull Circuit: 900 MHz

Typical Performance (50 Ohm System)

Frequency	700 MHz	800 MHz	900 MHz	1000 MHz
Magnitude S21	13.8 dB	13.8 dB	13.4 dB	12.8 dB
Magnitude S11	-30.0 dB	-27.0 dB	-18.6 dB	-12.2 dB
Magnitude S22	-11.5 dB	-13.0 dB	-12.0 dB	-12.5 dB
NF	3.4 dB	3.1 dB	3.4 dB	3.4 dB
OIP3	48 dBm	48 dBm	48 dBm	48 dBm
Bias	Vds = 5.0 V, Id = 600 mA			

### Performance Charts

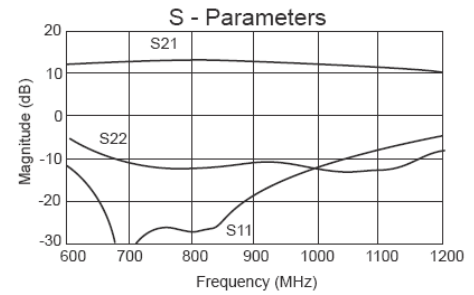

### Schematic

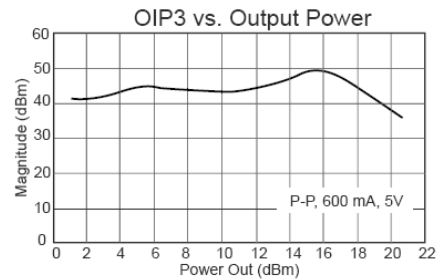
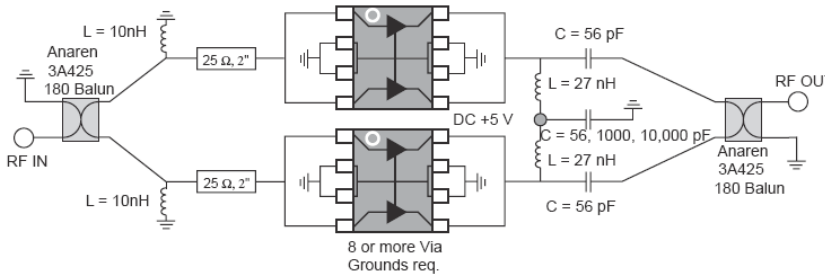

### FR4 Board Layout (T = 14 Mils to ground plane)

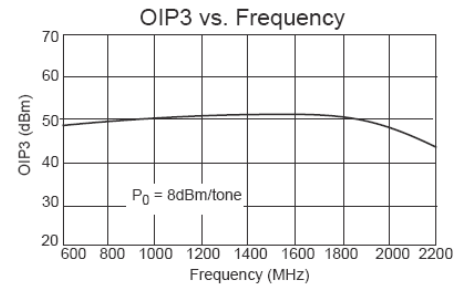
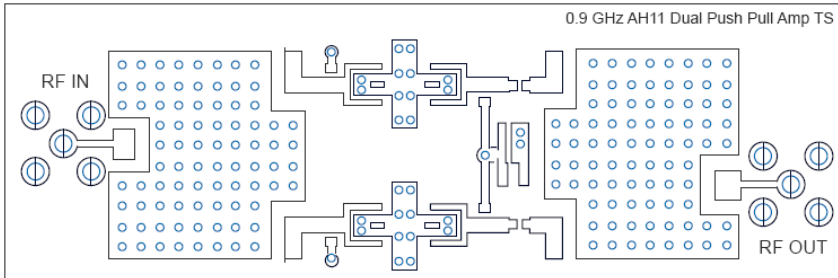

### Parts List

QTY	Description	Size	MFR	Part No.
2	Hi pwr Linear Amp	SOIC8	WJ	AH11
2	180 Balun 0.9 GHz		Anaren	3A425
5	56 pF Capacitor	0603	Kemet	
1	5000 pF Capacitor	0603	Kemet	
1	.01 uF Capacitor	0805	Kemet	
2	47 nH Inductor	0805	Coilcraft	0805CS-470XMBC
2	10 nH Inductor	0603	Toko	LL 1608-F10NK

## Dual Push-Pull Circuit: 1900 MHz

Typical Performance (50 Ohm System)

Frequency	1700 MHz	1800 MHz	1900 MHz	2000 MHz
Magnitude S21	11.8 dB	11.9 dB	11.9 dB	11.6 dB
Magnitude S11	-10.0 dB	-14.0 dB	-19.0 dB	-10.0 dB
Manitude S22	-8.3 dB	-10.0 dB	-10.0 dB	-14.0 dB
NF	3.8 dB	3.6 dB	3.7 dB	3.6 dB
OIP3	47 dBm	47 dBm	48 dBm	48 dBm
Bias	Vds = 5.0 V, Id = 600 mA			

## Performance Charts

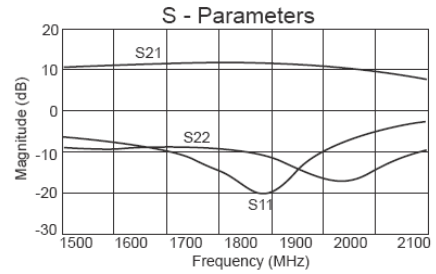

### Schematic

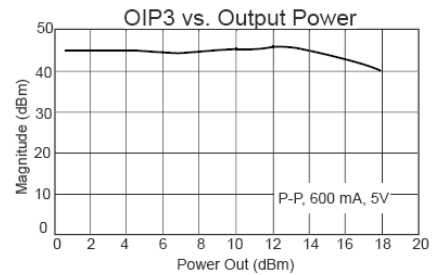
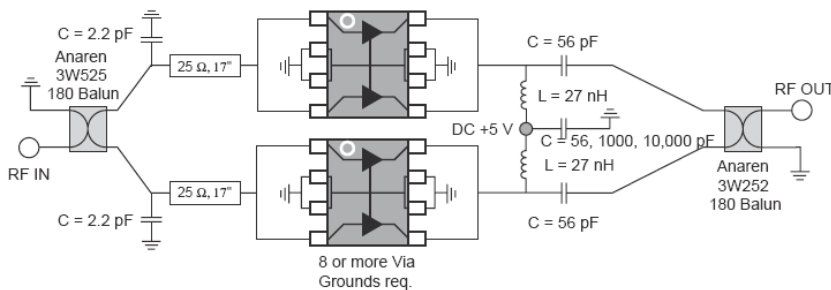

### FR4 Board Layout (T = 14 Mils to ground plane)

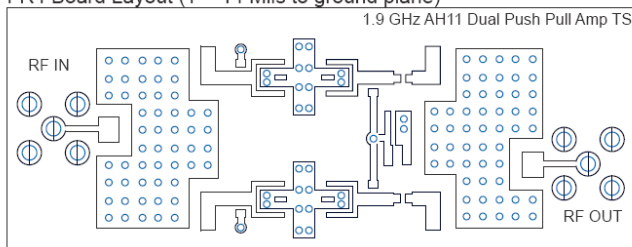

### Parts List

QTY	Description	Size	MFR	Part No.
2	Hi pwr Linear Amp	SOIC8	WJ	AH11
2	180 Balun 1.9 GHz		Anaren	3W525
5	56 pF Capacitor	0603	Kemet	
1	5000 pF Capacitor	0603	Kemet	
1	.01 uF Capacitor	0805	Kemet	
2	27 nH Inductor	0805	Coilcraft	0805CS-270XMBC
2	2.2 nH Inductor	0603	Toko	

## AH11-G Mechanical Information

This package is lead-free/Green/RoHS-compliant. The plating material on the leads is NiPdAu. It is compatible with both lead-free (maximum 260 °C reflow temperature) and lead (maximum 245 °C reflow temperature) soldering processes.

### Outline Drawing

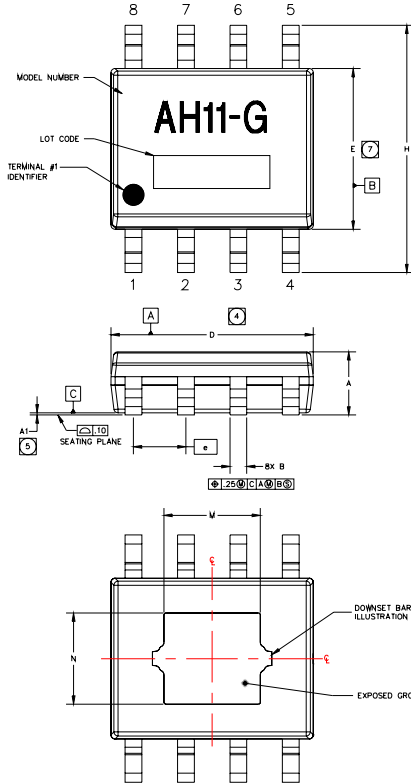

- NOTES:
- EXCEPT WHERE NOTED, THIS PART OUTLINE CONFORMS TO JEDEC STANDARD MS-012, ISSUE C FOR SMALL OUTLINE (S2) PERIPHERAL TERMINALS 3.75mm BODY WIDTH (PLASTIC).
  - DIMENSIONING & TOLERANCING CONFORM TO ANSI Y14.4M-1994.
  - ALL DIMENSIONS ARE IN MILLIMETERS (INCHES). ANGLES ARE IN DEGREES.
  - DOES NOT INCLUDE MOLD FLASH, PROTRUSIONS OR GATE BURRS, WHICH SHALL NOT EXCEED .15mm(.006in) PER SIDE.
  - DEVIATION FROM JEDEC MS-012 STANDARD.
  - LENGTH OF TERMINAL FOR SOLDERING TO A SUBSTRATE.
  - DOES NOT INCLUDE INTER-LEAD FLASH OR PROTRUSIONS, WHICH SHALL NOT EXCEED .25mm(.010in) PER SIDE.

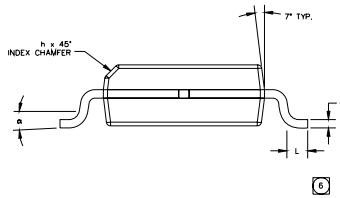

SYMBOL	MILLIMETERS			INCHES		
	MIN	NOM	MAX	MIN	NOM	MAX
A	1.42	1.52	1.62	.056	.060	.064
A1	0	.05	.10	0	.002	.004
B	.38	.41	.43	.015	.016	.017
C	.19	.20	.25	.007	.008	.010
D	4.80	4.90	5.00	.189	.193	.197
E	3.80	3.90	4.00	.150	.154	.157
e	1.27 BSC			.050 BSC		
H	5.80	6.0	6.20	.228	.236	.244
h	.25	.33	.50	.01	.013	.02
L	.40	.84	1.27	.016	.033	.050
M	2.21	2.34	2.47	.087	.092	.097
N	2.08	2.21	2.34	.082	.087	.092
a	0	4*	8*	0	4*	8*

### Land Pattern

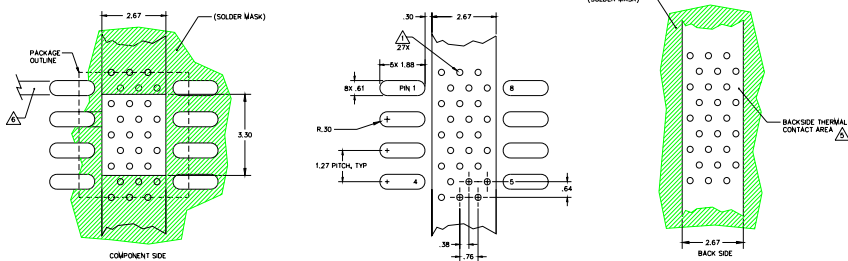

### Product Marking

The component will be marked with an "AH11-G" designator with an alphanumeric lot code on the top surface of the package. The obsolete tin-lead package is marked with an "AH11" designator followed by an alphanumeric lot code.

Tape and reel specifications for this part are located on the website in the "Application Notes" section.

### ESD / MSL Information

ESD Rating: Class 1B  
 Value: Passes from 500 to 1000 V  
 Test: Human Body Model (HBM)  
 Standard: JEDEC Standard JESD22-A114

ESD Rating: Class IV  
 Value: Passes greater than 1000 V  
 Test: Charge Device Model (CDM)  
 Standard: JEDEC Standard JESD22-C101

MSL Rating: Level 2 at +260 °C convection reflow  
 Standard: JEDEC Standard J-STD-020A

### Functional Pin Layout

Pin	Function
1	RF input (Amp1 input)
2	Ground
3	Ground
4	RF input (Amp2 input)
5	RF output (Amp2 output)
6	Ground
7	Ground
8	RF output (Amp1 output)

The backside paddle is the Source and should be grounded for thermal and electrical purposes.

### Mounting Config. Notes

- Ground / thermal vias are critical for the proper performance of this device. Vias should use a .35mm (#80/.0135") diameter drill and have a final plated through diameter of .25mm (.010")
- Add as much copper as possible to inner and outer layers near the part to ensure optimal thermal performance.
- To ensure reliable operation, device ground paddle-to-ground pad solder joint is critical.
- Add mounting screws near the part to fasten the board to a heatsink. Ensure that the ground / thermal via region contacts the heatsink.
- For optimal thermal performance, expose soldermask on backside where it contacts the heatsink.
- RF trace width depends upon the PC board material and construction.
- Use 1 oz. Copper minimum.
- If the PCB design rules allow, ground vias should be placed under the land pattern for better RF and thermal performance. Otherwise ground vias should be placed as close to the land pattern as possible.
- All dimensions are in mm. Angles are in degrees.

Specifications and information are subject to change without notice



# AH11

## High Dynamic Range Dual Amplifier



### Typical Device Data

S-Parameters, single unmatched device (2 per package):  $V_{DS} = +5\text{ V}$ , 100%  $I_{DSS}$ ,  $T = 25\text{ }^\circ\text{C}$ , 50  $\Omega$  system, calibrated to device leads

Freq (MHz)	S11 (dB)	S11 (ang)	S21 (dB)	S21 (ang)	S12 (dB)	S12 (ang)	S22 (dB)	S22 (ang)
50	-2.63	-31.03	17.82	162.23	-23.39	47.82	-6.12	-36.95
250	-9.02	-47.58	14.82	156.18	-20.06	8.90	-16.47	-55.07
500	-9.98	-61.76	14.31	144.67	-20.01	-1.10	-20.37	-43.85
750	-10.09	-83.24	13.83	132.14	-20.02	-6.79	-21.92	-31.28
1000	-10.11	-102.89	13.29	119.28	-20.11	-11.57	-21.92	-23.71
1250	-9.98	-122.71	12.76	106.77	-20.25	-14.32	-22.27	-17.24
1500	-9.69	-141.39	12.18	94.43	-20.31	-18.20	-22.53	-17.00
1750	-9.28	-159.83	11.61	83.21	-20.53	-21.39	-22.93	-10.89
2000	-8.86	-175.83	11.06	72.08	-20.71	-24.33	-23.65	-9.69
2250	-8.41	169.88	10.49	61.25	-20.82	-27.30	-23.68	-13.98
2500	-7.81	155.71	9.92	50.78	-20.98	-29.62	-23.88	-1.56
2750	-7.26	143.52	9.41	41.01	-21.11	-31.71	-25.42	-1.60
3000	-6.70	133.22	8.81	31.62	-21.22	-34.23	-24.24	5.13

Device S-parameters are available for download from the website at: <http://www.wj.com>