

AVR-P20 development board

Users Manual



All boards produced by Olimex are ROHS compliant

Revision A, October 2005

Copyright(c) 2009, OLIMEX Ltd, All rights reserved

INTRODUCTION:

The **AVR Microcontrollers** are low-power CMOS 8-bit controller based on the RISC architecture. The AVR core combines a rich instruction set with general purpose working registers. All the registers are directly connected to the Arithmetic Logic Unit (ALU), allowing two independent registers to be accessed in one single instruction executed in one clock cycle. The resulting architecture is more code efficient while achieving throughputs up to ten times faster than conventional CISC microcontrollers.

AVR-P20 is prototype board for 20 pin AVR microcontrollers with STKxxx compatible 10 pin ICSP connector.

BOARD FEATURES:

- STK200 compatible ICSP 5x2 pin connector for in-circuit programming with AVR-PG1B or AVR-PG2B
- RS232 Tx, Rx interface with MAX232 IC on socket
- 10MHz crystal on socket (user can replace with any value)
- reset IC ZM33064
- reset button
- general purpose push button
- status LED connected to PB7 via removable jumper
- DIL20 microcontroller socket
- selectable +3.3V / +5V power supply voltage regulator
- extension pin headers for each uC pin
- four mounting holes 3.3 mm (0.13")
- FR-4, 1.5 mm (0,062"), green soldermask, white silkscreen component print
- dimensions 100x80 mm (3.9x3.15")

ELECTROSTATIC WARNING:

The AVR-P20 board is shipped in protective anti-static packaging. The board must not be subject to high electrostatic potentials. General practice for working with static sensitive devices should be applied when working with this board.

BOARD USE REQUIREMENTS:

Cables: The cable you will need depends on the programmer/ debugger you use. If you use [AVR-PG1](#), you will need RS232 cable, if you use [AVR-PG2](#), you will need LPT cable, if you use [AVR-ISP500](#), [AVR-ISP500-TINY](#) or [AVR-ISP500-ISO](#), you will need 1.8 meter USB A-B cable.

Hardware: Programmer - one of the Olimex AVR Programmers: AVR-PG1, AVR-PG2, AVR-ISP500, AVR-ISP500-TINY, AVR-ISP500-ISO.

SCHEMATIC:

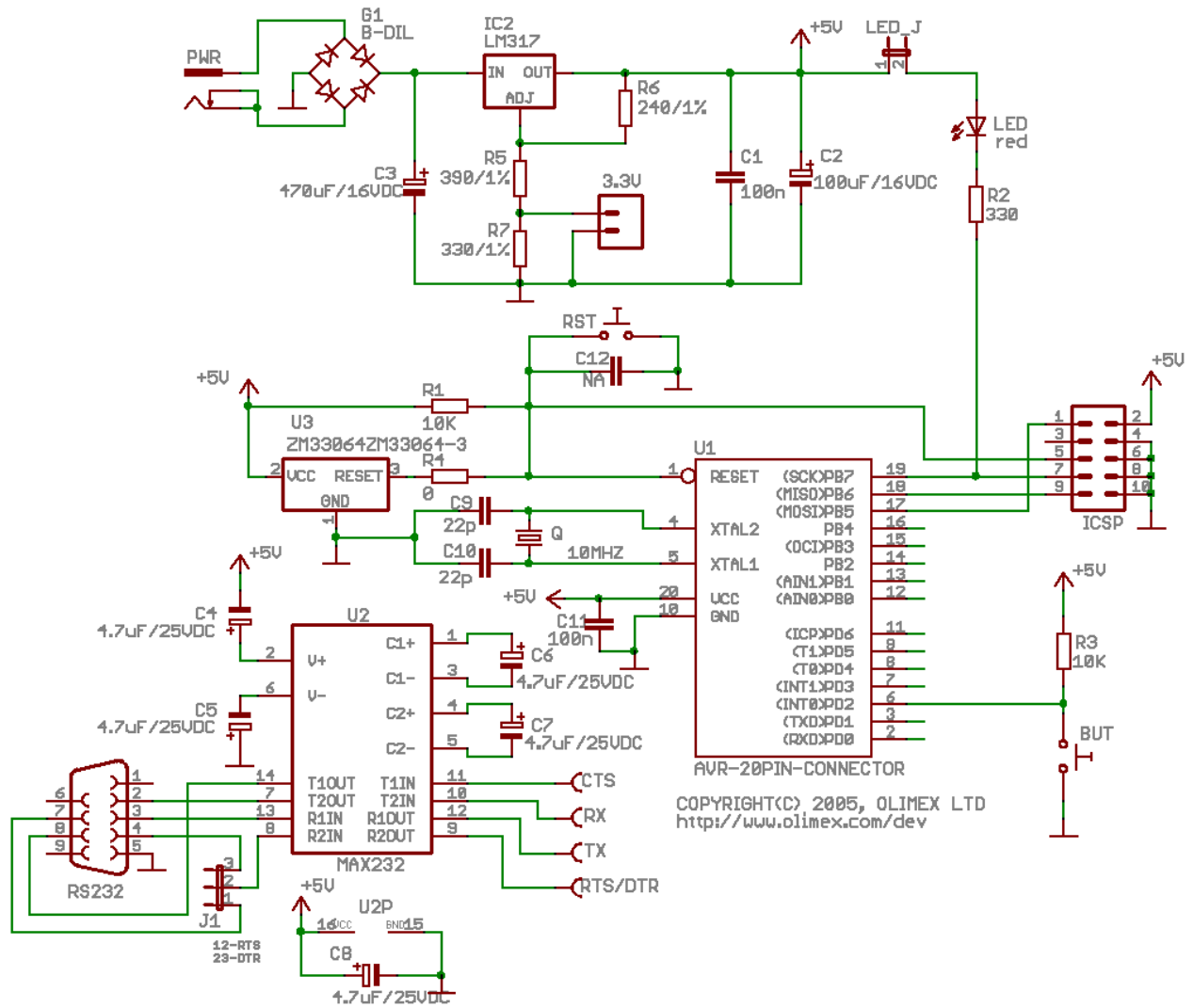

BOARD LAYOUT:

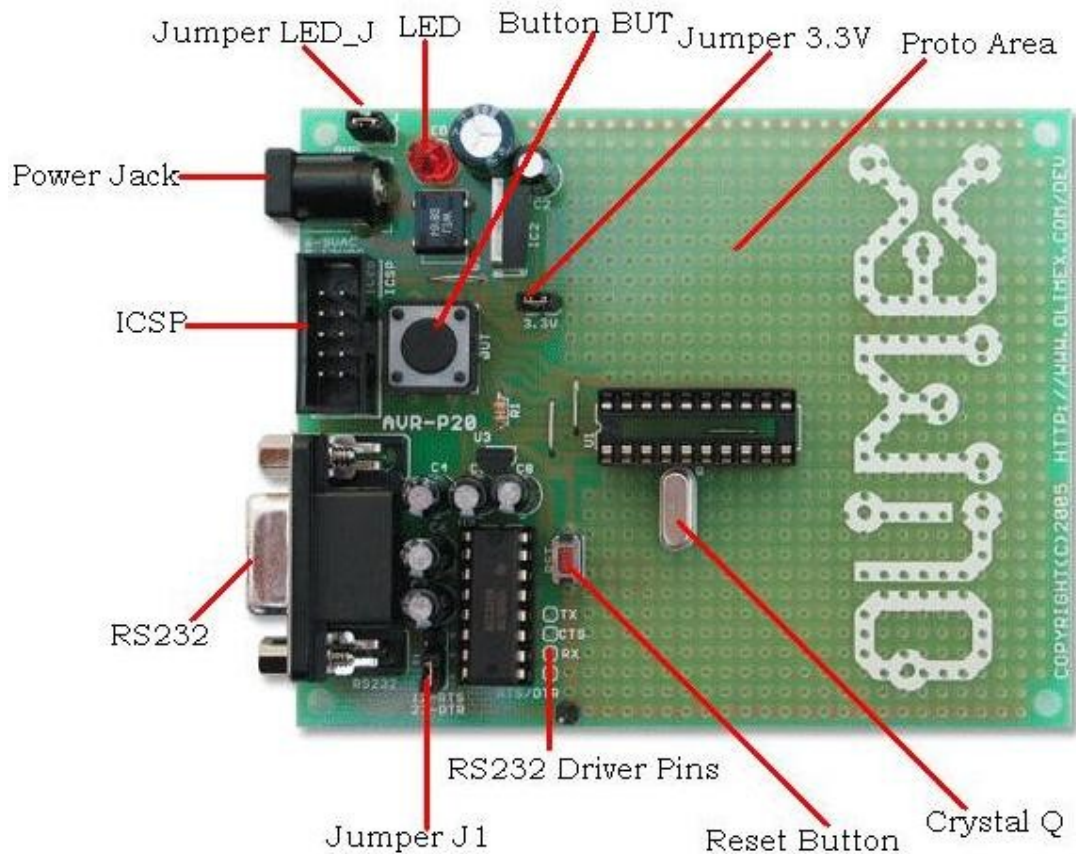

POWER SUPPLY CIRCUIT:

AVR-P20 is typically power supplied with min 9.0V DC max 12.0V DC, or min 6.0V AC max 9.0V AC.

RESET CIRCUIT:

AVR-P20 reset circuit includes pin 5 of ICSP connector, pin 1 of U1, Reset scheme - U3 and RESET button (RST).

CLOCK CIRCUIT:

Quartz crystal 10MHz is connected to AVR Microcontroller pin 4 (XTAL2) and pin 5 (XTAL1).

JUMPER DESCRIPTION:

J1

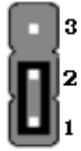

When 1-2 are shorted – RTS is connected to terminal pin RTS/DTR.
When 2-3 are shorted – DTR is connected to terminal pin RTS/DTR.
Default state is 1-2.

LED_J



When this jumper is open – LED is not connected.
When this jumper is closed – LED is connected to pin 19 (PB7/SCK) of the
Microcontroller.
Default state is closed.

3.3V



When this jumper is open – LM317 output is 5V DC.
When this jumper is closed – LM317 output is 3.3V DC.
Default state is open.

WARNINGS!!!

**1. The 3.3V jumper selects the power voltage to be 5V (open) or 3.3V (closed).
MAX232 can operate only at 5V power supply so if you are working with 3.3V you should replace it
with MAX3232 which works at 3.3V power supply.**

2. If you want to operate with 3,3V power supply, remove R4 resistor.

INPUT/OUTPUT:

Status Led with name **LED (red)** – this led is connected to PIN19 (PB7 / SCK) via
jumper LED_J.

User button with name **BUT** - connected to PIN6 (PD2 / INT0).

Reset button with name **RST** - connected to PIN1 (RESET).

CONNECTOR DESCRIPTIONS:

ICSP:

PIN #	Signal Name	Functionality
1	MOSI	PB5 / MOSI
2	+5V	Supply
3	Not connected	-
4	GND	Ground
5	Reset	RESET
6	GND	Ground
7	SCK	PB7 / SCK
8	GND	Ground
9	MISO	PB6 / MISO
10	GND	Ground

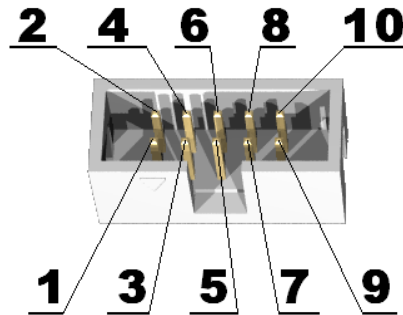

RS232:

PIN #	Signal Name
1	Not connected
2	RXD
3	TXD
4	DTR
5	GND
6	Not connected
7	RTS
8	CTS
9	Not connected

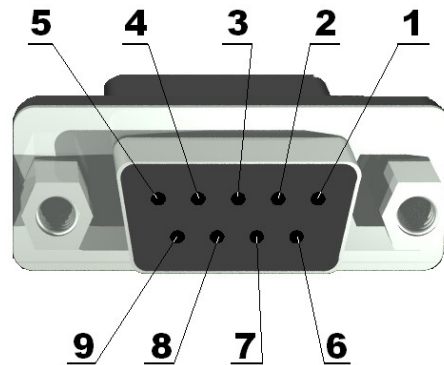

Note1: RTS and DTR is connected to terminal pins via jumper J1, which position was described above.

Note2: RX RS232 driver pins have to be connected to AVR microcontroller pin - TXD/PD1 (PIN 3).
TX RS232 driver pins have to be connected to AVR microcontroller pin - RXD/PD0 (PIN 2).

PWR:

PIN #	Signal Name
1	Power Input
2	GND

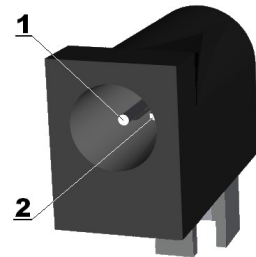

MECHANICAL DIMENSIONS:

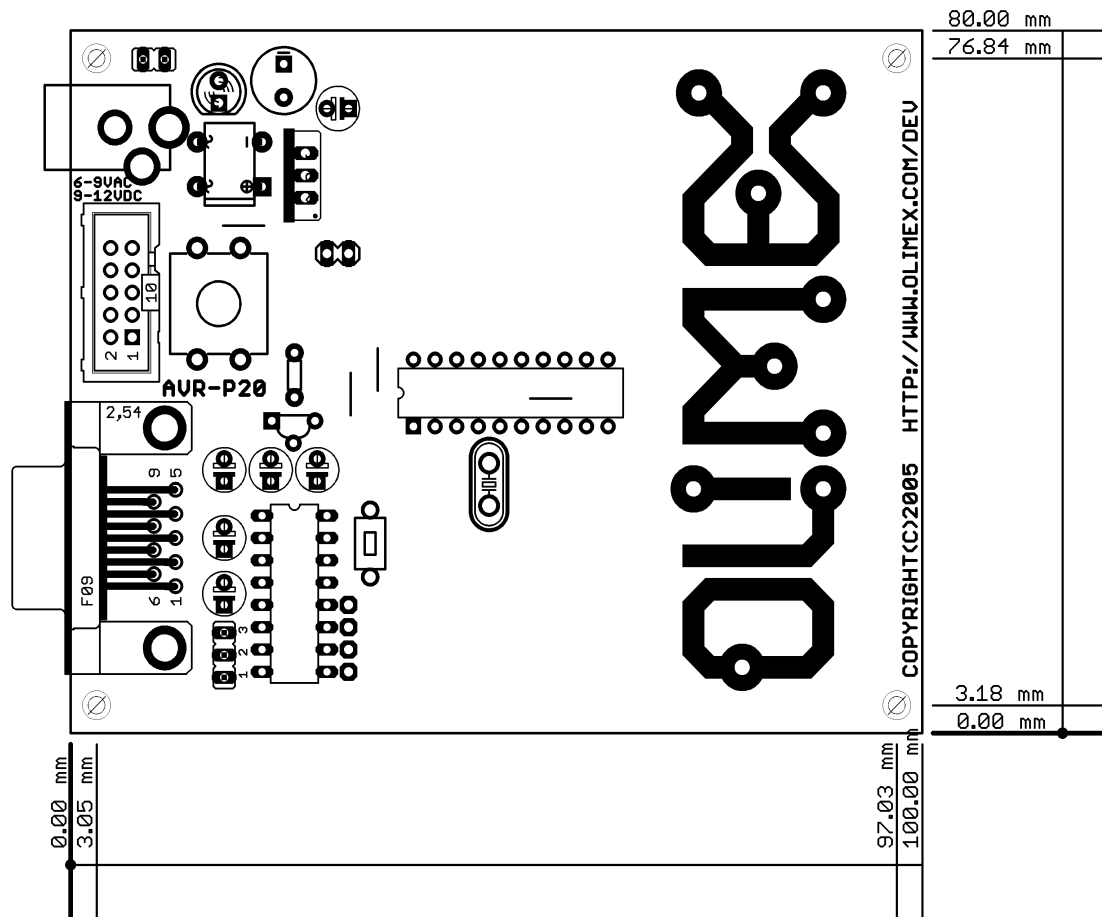

AVAILABLE DEMO SOFTWARE:

- AVR-P20 + AT90S2313 blink LED ([C source](#) and [HEX](#))
- AVR-P20 + AT90S2313 UART demo code ([C source](#) and [HEX](#)) and ([C source](#) and [HEX](#))
- AVR-P20 + AT90S2313 Button demo code ([C source](#) and [HEX](#))
- AVR-P20 + AT90S2313 demo ([C source](#) and [HEX](#))

ORDER CODE:

AVR-P20 Completely assembled and tested with 10Mhz crystal on board
AVR-P20/PCB blank PCB.

How to order?

You can order to us directly or by any of our distributors.

Check our web www.olimex.com/dev for more info.

Revision history:

REV.A - created October 2005

Disclaimer:

© 2009 Olimex Ltd. All rights reserved. Olimex®, logo and combinations thereof, are registered trademarks of Olimex Ltd. Other terms and product names may be trademarks of others.

The information in this document is provided in connection with Olimex products. No license, express or implied or otherwise, to any intellectual property right is granted by this document or in connection with the sale of Olimex products.

Neither the whole nor any part of the information contained in or the product described in this document may be adapted or reproduced in any material form except with the prior written permission of the copyright holder.

The product described in this document is subject to continuous development and improvements. All particulars of the product and its use contained in this document are given by OLIMEX in good faith. However all warranties implied or expressed including but not limited to implied warranties of merchantability or fitness for purpose are excluded.

This document is intended only to assist the reader in the use of the product. OLIMEX Ltd. shall not be liable for any loss or damage arising from the use of any information in this document or any error or omission in such information or any incorrect use of the product.