

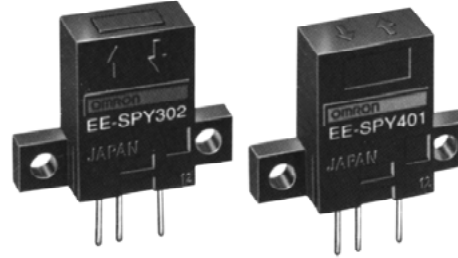

EE-SPY301/401/302/402

Slim, Diffuse Sensor Detects Objects Without Background Interference

- Light modulation effectively reduces external light interference
- Easy adjustment and optical axis monitoring with a Light-ON indicator
- Wide operating voltage range (5 to 24 VDC) makes smooth connection possible with a TTLs, relays, and programmable controllers (PLCs)
- Easy-to-wire connector ensures ease of maintenance
- Convert to PNP output with EE-2001 conversion connector



Ordering Information

Appearance	Sensing method	Sensing distance	Output configuration	Weight	Part number
Horizontal 	Diffuse	5 mm	Dark-ON	Approx. 2.6 g	EE-SPY301
			Light-ON		EE-SPY401
Vertical 			Dark-ON		EE-SPY302
			Light-ON		EE-SPY402

ACCESSORIES

Name	Part number
Solder connector	EE-1002
Connector with 1 m cable	EE-1003
Connector holder for EE-1003	EE-1003A

Specifications

■ RATINGS

Item		Reflective			
		EE-SPY301	EE-SPY401	EE-SPY302	EE-SPY402
Supply voltage		5 to 24 VDC $\pm 10\%$, ripple (p-p): 5% max.			
Current consumption		Average: 15 mA max.; Peak: 50 mA max.			
Rated sensing distance		5 mm (Reflection factor: 90%; white paper: 15 x 15 mm)			
Standard reference object		Transparent, opaque			
Differential distance		0.2 mm (with a sensing distance of 3 mm, horizontally)			
Control output		At 5 to 24 VDC: 80-mA load current (I_C) with a residual voltage of 1.0 V max. When driving TTL: 10-mA load current (I_C) with a residual voltage of 0.4 V max.			
Output configuration	Transistor on output stage without detecting object	ON	OFF	ON	OFF
	Transistor on output stage with detecting object	OFF	ON	OFF	ON
	With detecting object	ON			
Indicator*	Without detecting object	OFF			
	With detecting object	ON			
Response frequency**		100 Hz			
Light source		GaAs infrared LED (pulse-modulated) with a peak wavelength of 940 nm			
Receiver		Si photo-diode with a sensing wavelength of 850 nm max.			
Connecting method		EE-1002/1003 Connectors			

*The indicator is a GaP red LED (peak emission wavelength: 700 nm).

**The response frequency was measured by detecting the following disks rotating.

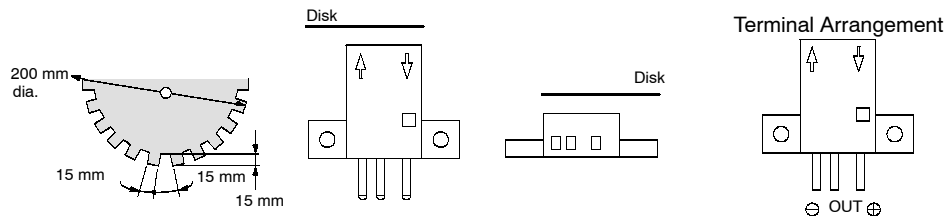

■ CHARACTERISTICS

Ambient illumination		Sensing face: fluorescent light/incandescent light: 3,000 lx max.
Enclosure ratings		IP50
Ambient temperature	Operating	-10° to 55°C (14°F to 131°F)
	Storage	-25° to 65°C (-13°F to 149°F)
Ambient humidity	Operating	35% to 85%
	Storage	35% to 95%
Vibration resistance		Destruction: 10 to 55 Hz, 1.5-mm double amplitude for 2 hrs each in X, Y, and Z directions
Shock resistance		Destruction: 500 m/s ² (approx. 50G) for 3 times each in X, Y, and Z directions
Cable length		2 m max. with a thickness of 0.3 mm ² min.

Engineering Data

OPERATING RANGE (TYPICAL)

EE-SPY301, EE-SPY401

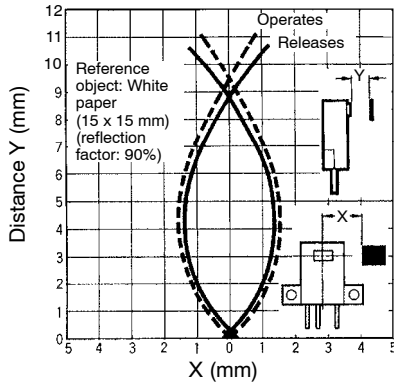

EE-SPY301, EE-SPY401

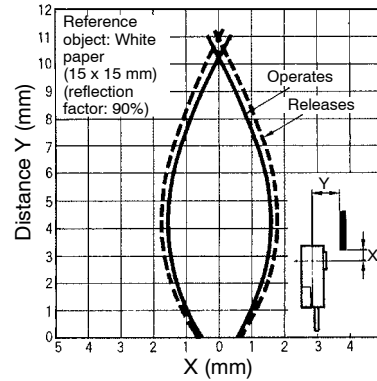

EE-SPY302, EE-SPY402

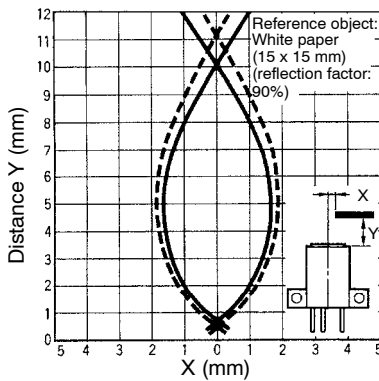

EE-SPY302, EE-SPY402

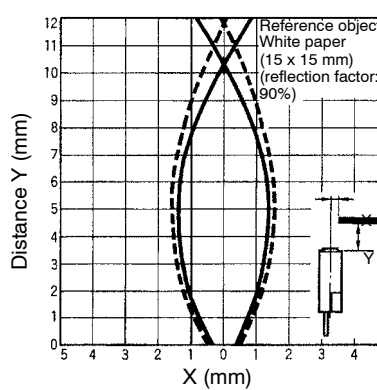

SENSING DISTANCE VS. OBJECT AREA (TYPICAL)

EE-SPY301/SPY302/SPY401/SPY402

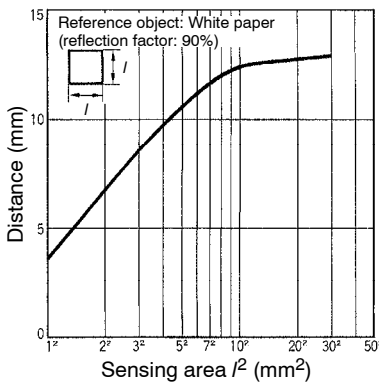

OPERATING/RESET DISTANCE VS. CABLE LENGTH (TYPICAL)

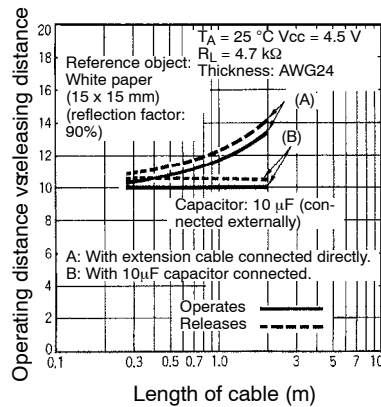

SENSING ANGLE VS. SENSING DISTANCE (TYPICAL)

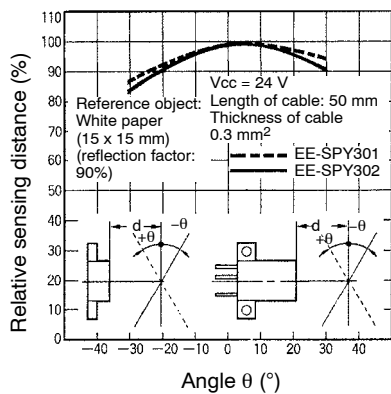

RECEIVER OUTPUT VS. SENSING DISTANCE (TYPICAL)

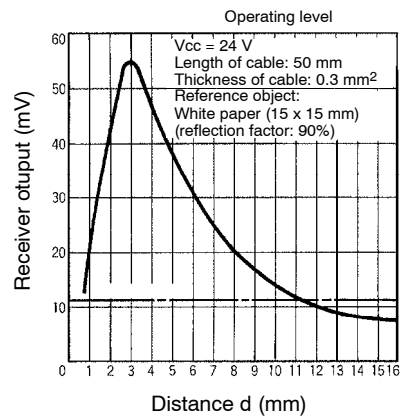

Operation

INTERNAL/EXTERNAL CIRCUIT DIAGRAM

Light-ON/Dark-ON

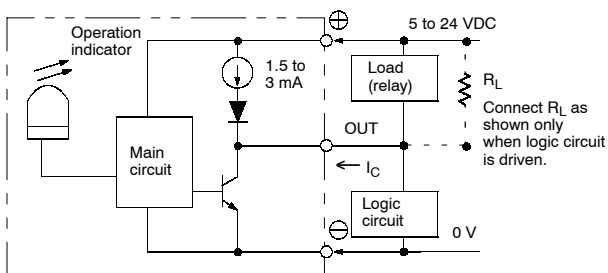

Connect a diode in parallel to the load when an inductive load is connected between + and OUT.

TIMING CHART

Light-ON

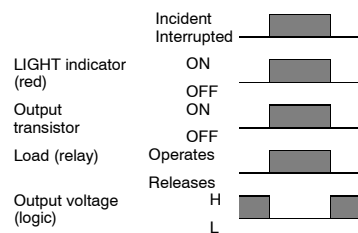

Dark-ON

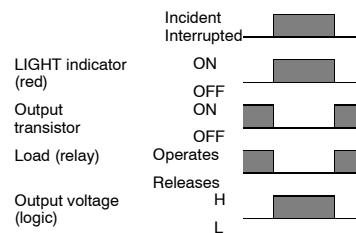

Dimensions

Unit: mm (inch)

EE-SPY301, EE-SPY401

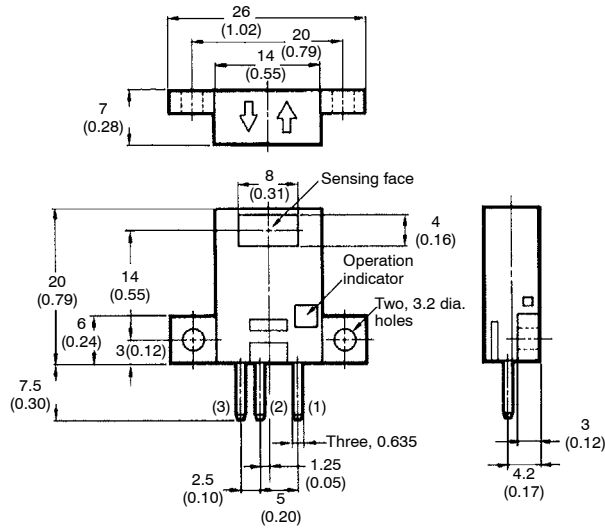
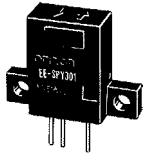

Terminal Arrangement

(1)	⊕	V _{CC}
(2)	OUT	OUTPUT
(3)	⊖	GND (0 V)

EE-SPY302, EE-SPY402

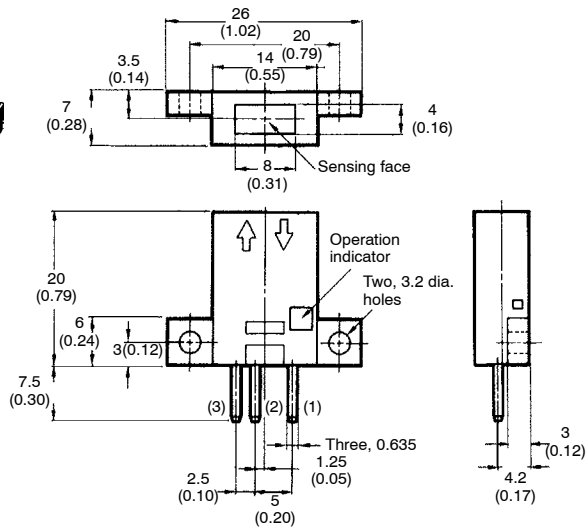
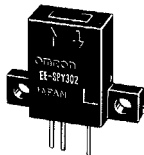

Terminal Arrangement

(1)	⊕	V _{CC}
(2)	OUT	OUTPUT
(3)	⊖	GND (0 V)

■ EE-1002 CONNECTOR

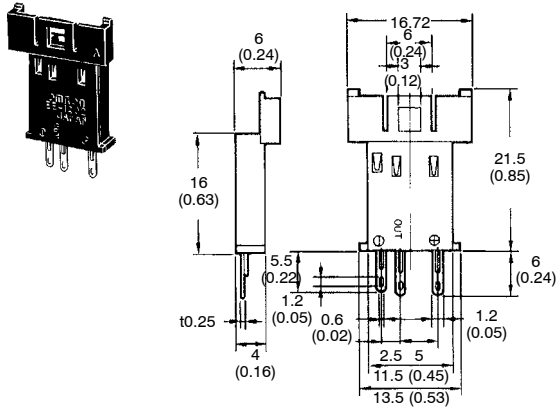

■ EE-1003 CONNECTOR

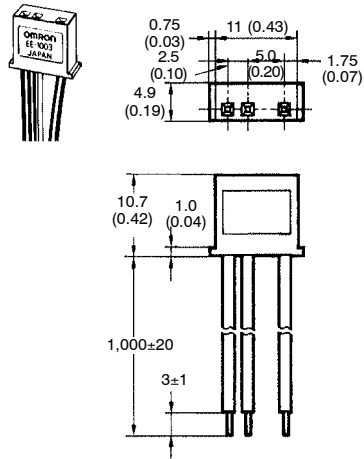

■ EE-SPY301 + EE-1003

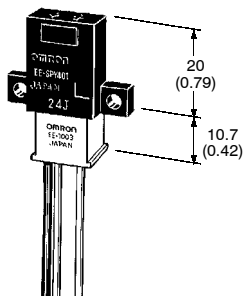

■ EE-1003A CONNECTOR HOLDER

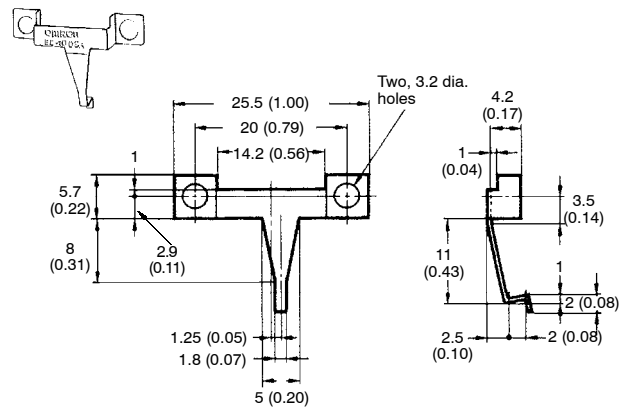

Precautions

Refer to the Technical Information Section for general precautions.

■ WIRING

A cable with a thickness of 0.3 mm² or AWG22 min. and a length of 2 m max. must be connected to the output terminals.

To use a cable longer than 2 m, attach a capacitor with a capacitance of approximately 10 µF to the wires, as shown below. The distance between the terminal and the capacitor must be within 2 m:

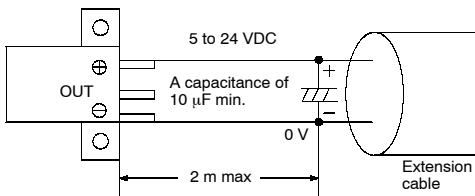

Do not solder the cable to the connectors. Use the EE-1002 Connector or EE-1003 Connector (with a 1-m cable attached) to connect the cable to the output terminals.

Use the EE1003A Connector Holder to prevent accidental disconnection of the EE-1003 Connector from the EE-SPY301/401/302/402 Photomicrosensor.

Do not impose excessive force on the terminals (refer to the diagram below). Excess force will damage the terminals.

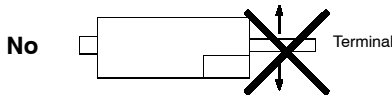

Do not disconnect the EE-1001 or EE-1006 Connector from the photomicrosensor when power is supplied to the photomicrosensor, or sensor damage could result.

If the metal mounting base is subjected to inductive electrical noise, the photomicrosensor can be activated accidentally. If noise is a problem, take the following countermeasures:

1. Connect the negative terminal to the mounting base so that there will be no difference in electric potential between the photomicrosensor and mounting base.
2. Connect the negative terminal to the mounting base via a 0.47-µF capacitor.

3. Insert a plastic insulating plate with a thickness of approximately 10 mm between the photomicrosensor and mounting base.

Wire as shown by the following illustration to connect a small inductive load (a relay for example) to the photomicrosensor. A diode must be connected parallel to the relay to absorb the reverse voltage.

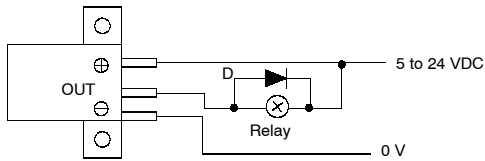

When using a standard switching regulator, ground the FG and G terminal to ensure that the photomicrosensor will be in a stable operating condition.

■ POWER SUPPLY

When using a standard switching regulator, ground the FG and G terminal to ensure that the photomicrosensor will be in a stable operating condition.

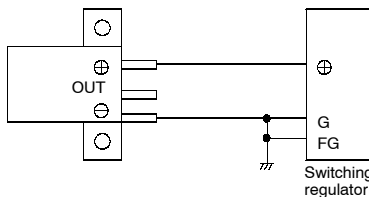

NOTE: DIMENSIONS SHOWN ARE IN MILLIMETERS. To convert millimeters to inches divide by 25.4.

OMRON®

OMRON ELECTRONICS LLC

One East Commerce Drive
Schaumburg, IL 60173

1-800-55-OMRON

OMRON ON-LINE

Global - <http://www.omron.com>

USA - <http://www.omron.com/oei>

Canada - <http://www.omron.com/oci>

OMRON CANADA, INC.

885 Milner Avenue
Toronto, Ontario M1B 5V8

416-286-6465