

FODM3062, FODM3063, FODM3082, FODM3083 4-Pin Full Pitch Mini-Flat Package Zero-Cross Triac Driver Output Optocouplers

Features

- dv/dt of 600V/ μ s guaranteed
- Compact 4-pin surface mount package (2.4mm maximum standoff height)
- Zero voltage crossing
- Peak blocking voltage: 600V (FODM306X)
800V (FODM308X)
- Available in tape and reel quantities of 2500
- C-UL, UL and VDE certifications pending

Applications

- Solenoid/valve controls
- Lighting controls
- Static power switches
- AC motor drives
- Temperature controls
- E.M. contactors
- AC motor starters
- Solid state relays

Description

The FODM306X and FODM308X series consist of an infrared emitting diode optically coupled to a monolithic silicon detector performing the function of a zero voltage crossing bilateral triac driver, and is housed in a compact 4-pin mini-flat package. The lead pitch is 2.54mm. They are designed for use with a triac in the interface of logic systems to equipment powered from 115/240 VAC lines, such as solid state relays, industrial controls, motors, solenoids and consumer appliances.

Package Dimensions

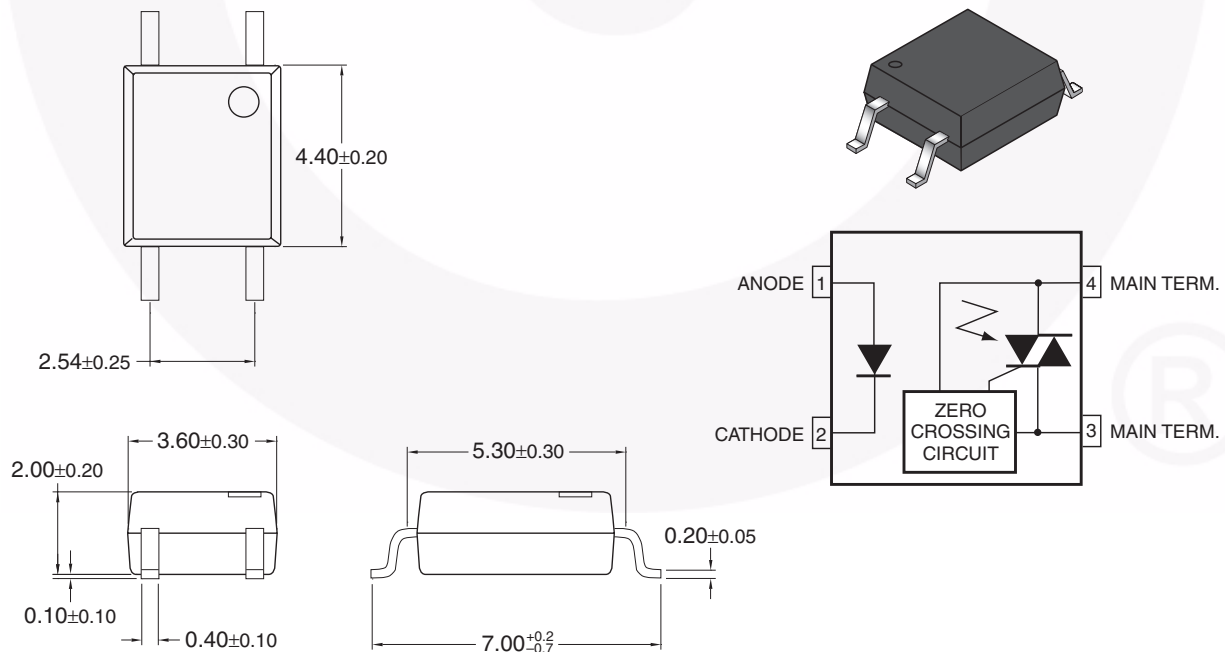

Note:

All dimensions are in millimeters.

Absolute Maximum Ratings ($T_A = 25^\circ\text{C}$ unless otherwise specified)

Stresses exceeding the absolute maximum ratings may damage the device. The device may not function or be operable above the recommended operating conditions and stressing the parts to these levels is not recommended. In addition, extended exposure to stresses above the recommended operating conditions may affect device reliability. The absolute maximum ratings are stress ratings only.

| Symbol | Parameter | Rating | Units |
|----------------------|---|-------------------|------------------|
| TOTAL PACKAGE | | | |
| T_{STG} | Storage Temperature | -55 to +150 | $^\circ\text{C}$ |
| T_{OPR} | Operating Temperature | -40 to +100 | $^\circ\text{C}$ |
| EMITTER | | | |
| I_F (avg) | Continuous Forward Current | 60 | mA |
| I_F (pk) | Peak Forward Current (1 μs pulse, 300pps.) | 1 | A |
| V_R | Reverse Input Voltage | 6 | V |
| P_D | Power Dissipation (No derating required over operating temp. range) | 100 | mW |
| DETECTOR | | | |
| $I_{T(RMS)}$ | On-State RMS Current | 70 | mA (RMS) |
| V_{DRM} | Off-State Output Terminal Voltage | FODM3062/FODM3063 | 600 |
| | | FODM3082/FODM3083 | 800 |
| P_D | Power Dissipation (No derating required over operating temp. range) | 300 | mW |

Electrical Characteristics ($T_A = 25^\circ\text{C}$)**Individual Component Characteristics**

| Symbol | Parameter | Test Conditions | Min. | Typ.* | Max. | Units |
|-------------------|--|--|------|-------|------|------------------|
| EMITTER | | | | | | |
| V_F | Input Forward Voltage | $I_F = 30\text{mA}$ | | | 1.5 | V |
| I_R | Reverse Leakage Current | $V_R = 6\text{V}$ | | | 100 | μA |
| DETECTOR | | | | | | |
| I_{DRM1} | Peak Blocking Current, Either Direction | Rated V_{DRM} , $I_F = 0^{(1)}$ | | | 500 | nA |
| dV/dt | Critical Rate of Rise of Off-State Voltage | $I_F = 0$ (Figure 1) ⁽²⁾ | 600 | | | V/ μs |

Transfer Characteristics

| Symbol | DC Characteristics | Test Conditions | Device | Min. | Typ.* | Max. | Units |
|-----------------|---|--|----------|------|-------|------|---------------|
| I_{FT} | LED Trigger Current | Main Terminal Voltage = $3\text{V}^{(3)}$ | FODM3062 | | | 10 | mA |
| | | | FODM3082 | | | | |
| | | | FODM3063 | | | 5 | |
| | | | FODM3083 | | | | |
| I_H | Holding Current, Either Direction | | All | | 300 | | μA |
| V_{TM} | Peak On-State Voltage, Either Direction | $I_F = \text{Rated } I_{\text{FT}}$, $I_{\text{TM}} = 100\text{mA peak}$ | All | | | 3 | V |

Zero Crossing Characteristics

| Symbol | Characteristics | Test Conditions | Device | Min. | Typ.* | Max. | Units |
|-------------------|--|--|--------|------|-------|------|-------|
| V_{IH} | Inhibit Voltage, MT1-MT2 Voltage above which device will not trigger | $I_F = \text{Rated } I_{\text{FT}}$ | All | | | 20 | V |
| I_{DRM2} | Leakage in Inhibit State | $I_F = \text{Rated } I_{\text{FT}}$, Rated V_{DRM} , Off-State | All | | | 2 | mA |

Isolation Characteristics

| Characteristics | Test Conditions | Symbol | Device | Min. | Typ.* | Max. | Units |
|---|---------------------------------|------------------|--------|------|-------|------|-------|
| Steady State Isolation Voltage ⁽⁴⁾ | (1 Minute) R.H. = 40% to 60% | V_{ISO} | All | 3750 | | | VRMS |

*All typicals at 25°C .**Notes:**

1. Test voltage must be applied within dv/dt rating.
2. This is static dv/dt. See Figure 1 for test circuit. Commutating dv/dt is function of the load-driving thyristor(s) only.
3. All devices are guaranteed to trigger at an I_F value less than or equal to max I_{FT} . Therefore, recommended operating I_F lies between max I_{FT} (10mA for FODM3062/82, 5mA for FODM3063/83) and absolute max I_F (60 mA).
4. Steady state isolation voltage, V_{ISO} , is an internal device dielectric breakdown rating. For this test, pins 1 & 2 are common, and pins 3 & 4 are common.

Typical Performance Curves

Fig. 1 LED Forward Voltage vs. Forward Current

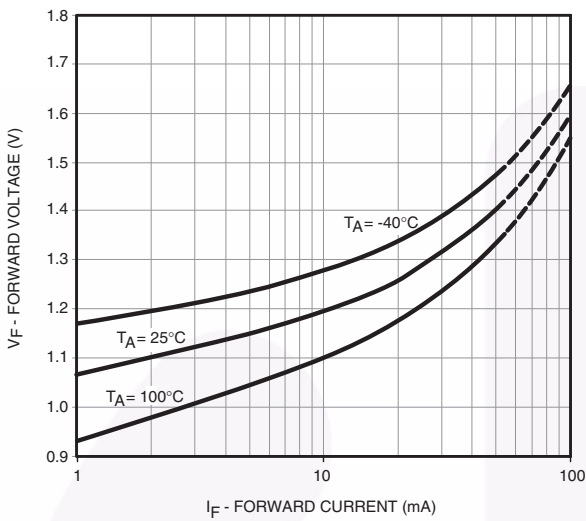

Fig. 2 Leakage Current vs. Ambient Temperature

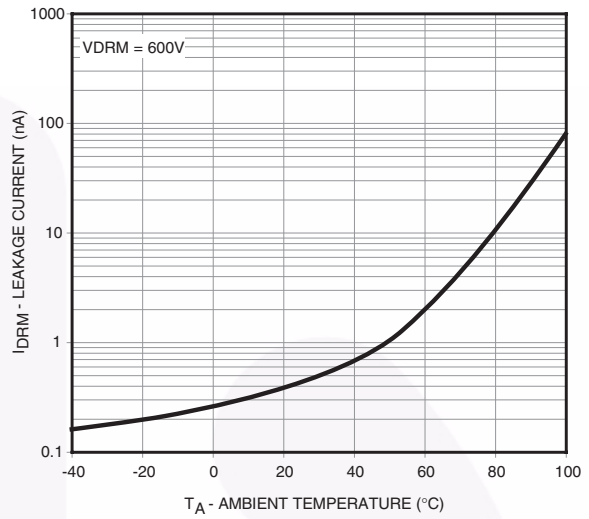

Fig. 3 Holding Current vs. Ambient Temperature

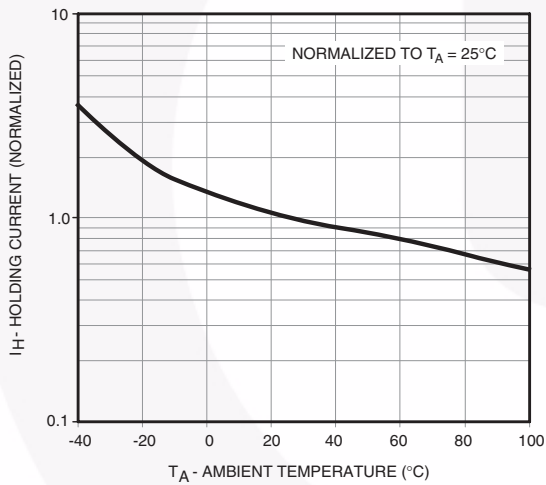
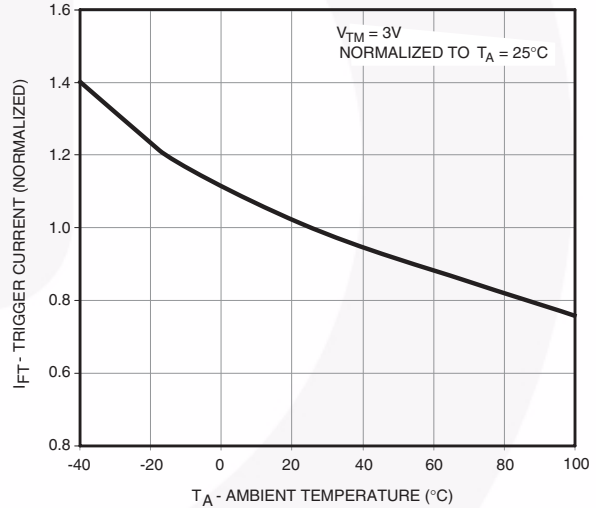

Fig. 4 Trigger Current vs. Ambient Temperature



Typical Performance Curves (Continued)

Fig. 5 LED Current Required to Trigger vs. LED Pulse Width

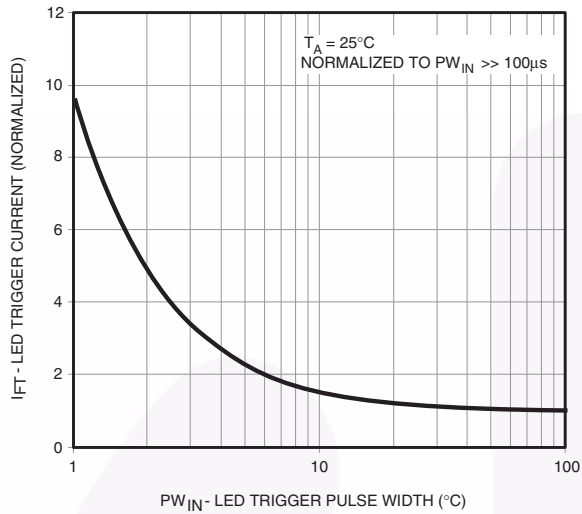

Fig. 6 Off-State Output Terminal Voltage vs. Ambient Temperature

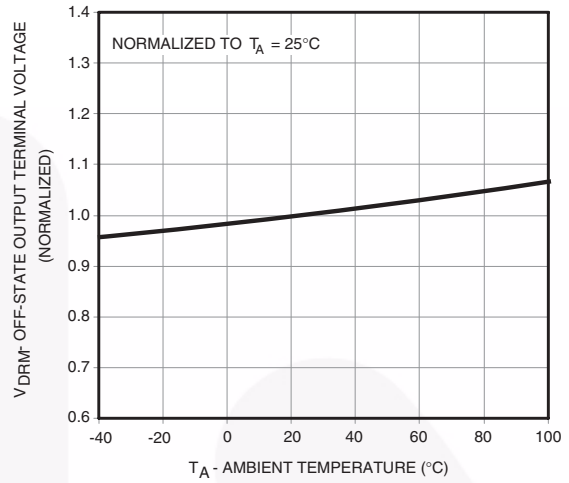
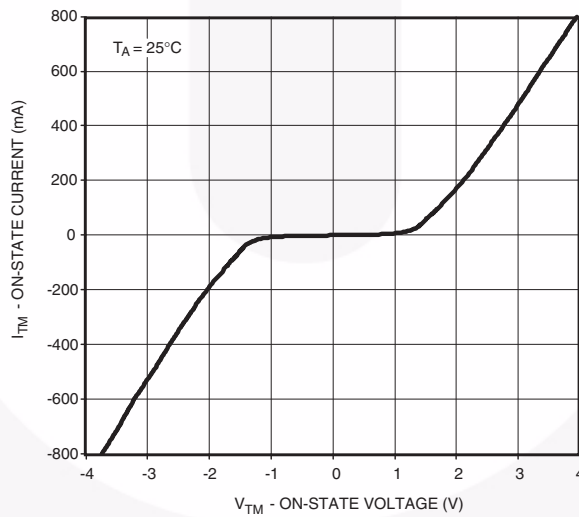

Fig. 7 On-State Characteristics



Typical Applications

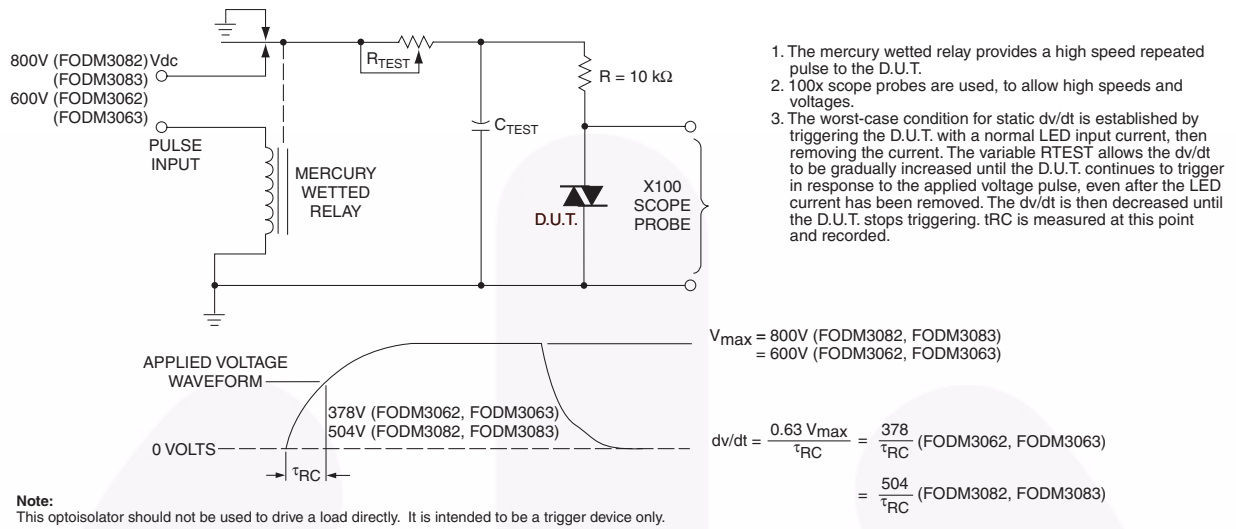

Figure 8. Static dv/dt Test Circuit

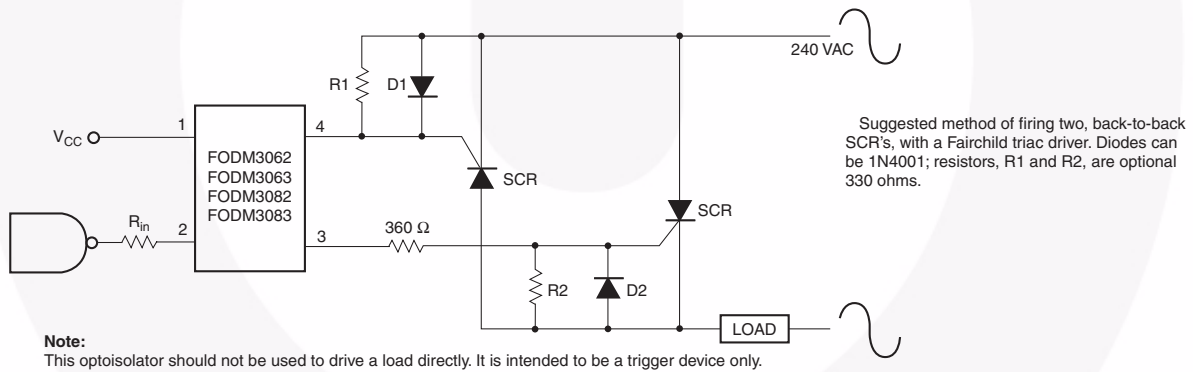

Figure 9. Inverse-Parallel SCR Driver Circuit (240VAC)

Determining the Power Rating of the Series Resistors Used in a Zero-Cross Opto-TRIAC Driver Application

The following will present the calculations for determining the power dissipation of the current limiting resistors found in an opto-TRIAC driver interface.

Figure 10 shows a typical circuit to drive a sensitive gate four quadrant power TRIAC. This figure provides typical resistor values for a zero line cross detecting opto-TRIAC when operated from a mains voltage of 20V to 240V. The wattage rating for each resistor is not given because their dissipation is dependent upon characteristics of the power TRIAC being driven.

Recall that the opto-TRIAC is used to trigger a four quadrant power TRIAC. Please note that these opto-TRIACs are not recommended for driving “snubberless” three quadrant power TRIACs.

Under normal operation, the opto-TRIAC will fire when the mains voltage is lower than the minimum inhibit trigger voltage, and the LED is driven at a current greater than the maximum LED trigger current. As an example for the FODM3063, the LED trigger current should be greater than 5mA, and the mains voltage is less than 10V peak. The inhibit voltage has a typical range of 10V minimum and 20V maximum. This means that if a sufficient LED current is flowing when the mains voltage is less than 10V, the device will fire. If a trigger appears between 10V and 20V, the device may fire. If the trigger occurs after the mains voltage has reached 20V_{peak}, the device will not fire.

The power dissipated from resistors placed in series with the opto-TRIAC and the gate of the power TRIAC is much smaller than one would expect. These current handling components only conduct current when the mains voltage is less than the maximum inhibit voltage. If the opto-TRIAC is triggered when the mains voltage is greater than the inhibit voltage, only the TRIAC leakage current will flow. The power dissipation in a 360Ω resistor shown in Figure 10 is the product of the resistance (360Ω) times the square of the current sum of main TRIAC’s gate current plus the current flowing gate to the MT2 resistor connection (330Ω). This power calculation is further modified by the duty factor of the duration for this current flow. The duty factor is the ratio of the turn-on time of the main TRIAC to the sine of the single cycle time. Assuming a main TRIAC turn-on time of 50μs and a 60Hz mains voltage, the duty cycle is approximately 0.6%. The opto-TRIAC only conducts current while triggering the main TRIAC. Once the main TRIAC fires, its on-state voltage is typically lower than the on-state sustaining voltage of the opto-TRIAC. Thus, once the main TRIAC fires, the opto-TRIAC is often shunted off. This situation results in very low power dissipation for both the 360Ω and 330Ω resistors, when driving a traditional four quadrant power TRIAC.

If a three quadrant “snubberless” TRIAC is driven by the opto-TRIAC, the calculations are different. When the main power TRIAC is driving a high power factor (resistive) load, it shuts off during the fourth quadrant.

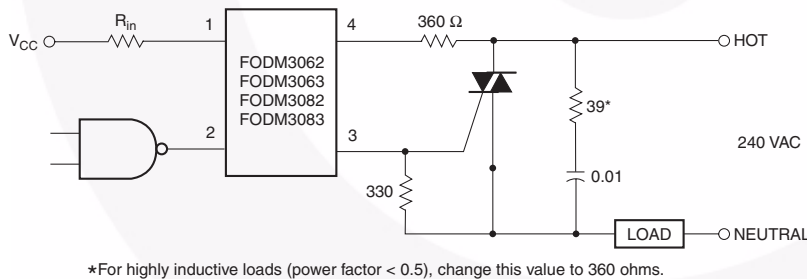

Figure 10. Hot-Line Switching Application Circuit

Typical circuit for use when hot line switching of 240VAC is required. In this circuit the “hot” side of the line is switched and the load connected to the cold or neutral side. The load may be connected to either the neutral or hot line.

R_{in} is calculated so that I_F is equal to the rated I_{FT} of the part, 5mA for the FODM3063/83 and 10mA for the FODM3062/82. The 39Ω resistor and 0.01μF capacitor are for snubbing of the triac and may or may not be necessary depending upon the particular triac and load used.

If sufficient holding current is still flowing through the opto-TRIAC, the opto-TRIAC will turn-on and attempt to carry the power TRIACs load. This situation typically causes the opto-TRIAC to operate beyond its maximum current rating, and product and resistor failures typically result. For this reason, using an opto-TRIAC to drive a three quadrant “snubberless” power TRIAC is not recommended.

Power in the 360Ω resistor, when driving a sensitive gate 4 quadrant power TRIAC:

$$\begin{aligned} I_{GT} &= 20\text{mA} \\ V_{GT} &= 1.5\text{V} \\ \text{DF} &= 0.6\% \end{aligned}$$

$$P = (I_{GT} + V_{GT} / 330\Omega)^2 \times 360\Omega \times \text{DF}$$

$$P = (20\text{mA} + 1.5 / 330\Omega)^2 \times 360\Omega \times 0.6\% = 1.3\text{mW}$$

A 1/4 watt resistor is more than adequate for both the 360Ω and 330Ω resistors.

The real power in the snubber resistor is based upon the integral of the power transient present when the load commutes. A fast commuting transient may allow a peak current of 4A to 8A in the snubbing filter. For best results, the capacitor should be a non-polarized AC unit with a low ESR. The 39Ω series resistor sets a time constant and limits the peak current. For a resistive load with a power factor near unity, the commutating transients will be small. This results in a very small peak current given the 0.01μF capacitor’s reactance. Normally, for fractional horsepower reactive loads, the resistor found in the snubber circuit will have a power rating from 1/2W to 2W. The resistor should be a low inductance type to adequately filter the high frequency transients.

Ordering Information

| Option | Description |
|-----------|---|
| No option | Bulk (100 units/tube) |
| V | VDE Approved |
| R2 | Tape and Reel (2500 units) |
| R2V | Tape and Reel (2500 units) and VDE Approved |

Marking Information

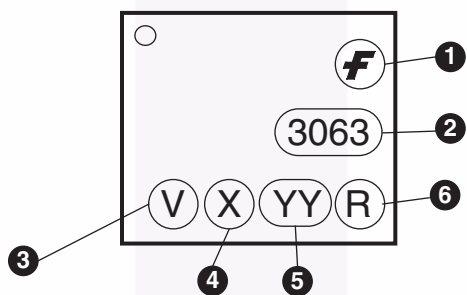

| Definitions | |
|-------------|--|
| 1 | Fairchild logo |
| 2 | Device number |
| 3 | VDE mark (Note: Only appears on parts ordered with VDE option – See order entry table) |
| 4 | One digit year code |
| 5 | Two digit work week ranging from '01' to '53' |
| 6 | Assembly package code |

Tape and Reel Information

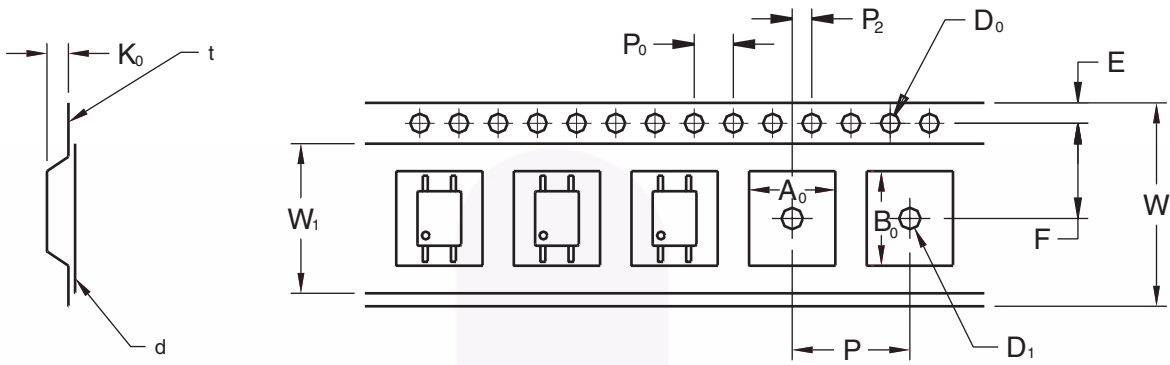

| | | 2.54 Pitch |
|---------------------------------|----------------|--------------|
| Description | Symbol | Dimensions |
| Tape Width | W | 12.00±0.4 |
| Tape Thickness | t | 0.35±0.02 |
| Sprocket Hole Pitch | P ₀ | 4.00±0.20 |
| Sprocket Hole Dia. | D ₀ | 1.55±0.20 |
| Sprocket Hole Location | E | 1.75±0.20 |
| Pocket Location | F | 5.50±0.20 |
| | P ₂ | 2.00±0.20 |
| Pocket Pitch | P | 8.00±0.20 |
| Pocket Dimension | A ₀ | 4.75±0.20 |
| | B ₀ | 7.30±0.20 |
| | K ₀ | 2.30±0.20 |
| Pocket Hole Dia. | D ₁ | 1.55±0.20 |
| Cover Tape Width | W ₁ | 9.20 |
| Cover Tape Thickness | d | 0.065±0.02 |
| Max. Component Rotation or Tilt | | 20° max |
| Devices Per Reel | | 2500 |
| Reel Diameter | | 330 mm (13") |

Footprint Drawing for PCB Layout

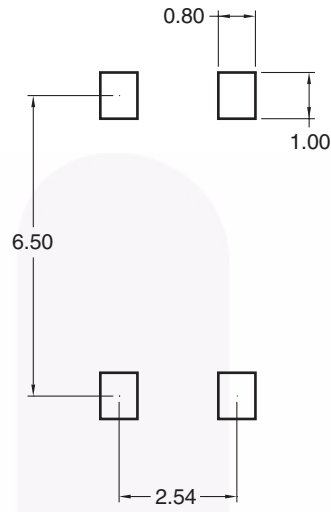

Note:
All dimensions are in mm.



Reflow Profile

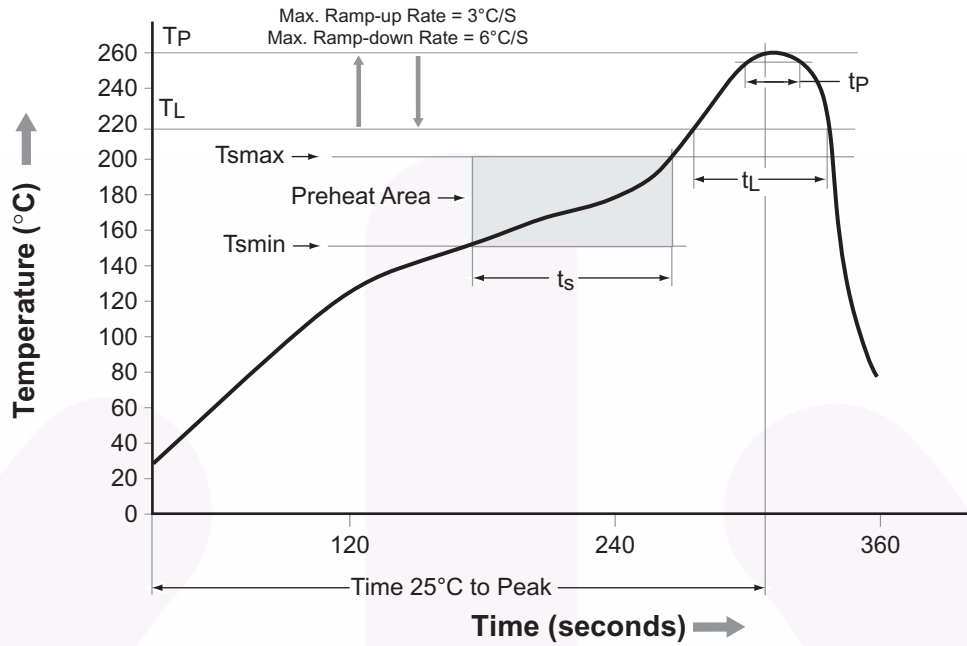

| Profile Feature | Pb-Free Assembly Profile |
|---|--------------------------|
| Temperature Min. (T _{smin}) | 150°C |
| Temperature Max. (T _{smax}) | 200°C |
| Time (t _s) from (T _{smin} to T _{smax}) | 60–120 seconds |
| Ramp-up Rate (t _L to t _p) | 3°C/second max. |
| Liquidous Temperature (T _L) | 217°C |
| Time (t _L) Maintained Above (T _L) | 60–150 seconds |
| Peak Body Package Temperature | 260°C +0°C / -5°C |
| Time (t _p) within 5°C of 260°C | 30 seconds |
| Ramp-down Rate (T _P to T _L) | 6°C/second max. |
| Time 25°C to Peak Temperature | 8 minutes max. |



TRADEMARKS

The following includes registered and unregistered trademarks and service marks, owned by Fairchild Semiconductor and/or its global subsidiaries, and is not intended to be an exhaustive list of all such trademarks.

| | | | |
|--------------------------|------------------------|---------------------------------------|---|
| AccuPower™ | F-PFS™ | Power-SPM™ | <p>SYSTEM GENERAL® The Power Franchise® the power franchise TinyBoost™ TinyBuck™ TinyCalc™ TinyLogic® TINYOPTO™ TinyPower™ TinyPWM™ TinyWire™ TriFault Detect™ TRUECURRENT™* "SerDes"™ SerDes™ UHC® Ultra FRFET™ UniFET™ VCX™ VisualMax™ XS™</p> |
| Auto-SPM™ | FRFET® | PowerTrench® | |
| Build it Now™ | Global Power Resource™ | PowerXS™ | |
| CorePLUS™ | Green FPS™ | Programmable Active Droop™ | |
| CorePOWER™ | Green FPS™ e-Series™ | QFET® | |
| CROSSVOLT™ | Gmax™ | QS™ | |
| CTL™ | GTO™ | Quiet Series™ | |
| Current Transfer Logic™ | IntelliMAX™ | RapidConfigure™ | |
| DEUXPEED® | ISOPLANAR™ | SignalWise™ | |
| Dual Cool™ | MegaBuck™ | Saving our world, 1mW/W/kW at a time™ | |
| EcoSPARK® | MICROCOUPLER™ | SmartMax™ | |
| EfficientMax™ | MicroFET™ | SMART START™ | |
| ESBC™ | MicroPak™ | SPM® | |
| Fairchild® | MicroPak2™ | STEALTH™ | |
| Fairchild Semiconductor® | MillerDrive™ | SuperFET™ | |
| FACT Quiet Series™ | MotionMax™ | SuperSOT™-3 | |
| FACT® | Motion-SPM™ | SuperSOT™-6 | |
| FAST® | OptoHiT™ | SuperSOT™-8 | |
| FastvCore™ | OPTOLOGIC® | SupreMOS® | |
| FETBench™ | OPTOPLANAR® | SyncFET™ | |
| FlashWriter®* | PDP SPM™ | Sync-Lock™ | |
| FPS™ | | | |

* Trademarks of System General Corporation, used under license by Fairchild Semiconductor.

DISCLAIMER

FAIRCHILD SEMICONDUCTOR RESERVES THE RIGHT TO MAKE CHANGES WITHOUT FURTHER NOTICE TO ANY PRODUCTS HEREIN TO IMPROVE RELIABILITY, FUNCTION, OR DESIGN. FAIRCHILD DOES NOT ASSUME ANY LIABILITY ARISING OUT OF THE APPLICATION OR USE OF ANY PRODUCT OR CIRCUIT DESCRIBED HEREIN; NEITHER DOES IT CONVEY ANY LICENSE UNDER ITS PATENT RIGHTS, NOR THE RIGHTS OF OTHERS. THESE SPECIFICATIONS DO NOT EXPAND THE TERMS OF FAIRCHILD'S WORLDWIDE TERMS AND CONDITIONS, SPECIFICALLY THE WARRANTY THEREIN, WHICH COVERS THESE PRODUCTS.

LIFE SUPPORT POLICY

FAIRCHILD'S PRODUCTS ARE NOT AUTHORIZED FOR USE AS CRITICAL COMPONENTS IN LIFE SUPPORT DEVICES OR SYSTEMS WITHOUT THE EXPRESS WRITTEN APPROVAL OF FAIRCHILD SEMICONDUCTOR CORPORATION.

As used herein:

1. Life support devices or systems are devices or systems which, (a) are intended for surgical implant into the body or (b) support or sustain life, and (c) whose failure to perform when properly used in accordance with instructions for use provided in the labeling, can be reasonably expected to result in a significant injury of the user.
2. A critical component in any component of a life support, device, or system whose failure to perform can be reasonably expected to cause the failure of the life support device or system, or to affect its safety or effectiveness.

ANTI-COUNTERFEITING POLICY

Fairchild Semiconductor Corporation's Anti-Counterfeiting Policy. Fairchild's Anti-Counterfeiting Policy is also stated on our external website, www.fairchildsemi.com, under Sales Support.

Counterfeiting of semiconductor parts is a growing problem in the industry. All manufacturers of semiconductor products are experiencing counterfeiting of their parts. Customers who inadvertently purchase counterfeit parts experience many problems such as loss of brand reputation, substandard performance, failed applications, and increased cost of production and manufacturing delays. Fairchild is taking strong measures to protect ourselves and our customers from the proliferation of counterfeit parts. Fairchild strongly encourages customers to purchase Fairchild parts either directly from Fairchild or from Authorized Fairchild Distributors who are listed by country on our web page cited above. Products customers buy either from Fairchild directly or from Authorized Fairchild Distributors are genuine parts, have full traceability, meet Fairchild's quality standards for handling and storage and provide access to Fairchild's full range of up-to-date technical and product information. Fairchild and our Authorized Distributors will stand behind all warranties and will appropriately address any warranty issues that may arise. Fairchild will not provide any warranty coverage or other assistance for parts bought from Unauthorized Sources. Fairchild is committed to combat this global problem and encourage our customers to do their part in stopping this practice by buying direct or from authorized distributors.

PRODUCT STATUS DEFINITIONS

Definition of Terms

| Datasheet Identification | Product Status | Definition |
|--------------------------|-----------------------|---|
| Advance Information | Formative / In Design | Datasheet contains the design specifications for product development. Specifications may change in any manner without notice. |
| Preliminary | First Production | Datasheet contains preliminary data; supplementary data will be published at a later date. Fairchild Semiconductor reserves the right to make changes at any time without notice to improve design. |
| No Identification Needed | Full Production | Datasheet contains final specifications. Fairchild Semiconductor reserves the right to make changes at any time without notice to improve the design. |
| Obsolete | Not In Production | Datasheet contains specifications on a product that is discontinued by Fairchild Semiconductor. The datasheet is for reference information only. |

Rev. I49