

Data Sheet



Description

The ACPL-827 is a DC-input dual channel full-pitch phototransistor optocoupler which contains two light emitting diode optically coupled to two separate transistor. It is packaged in a 8-pin DIP package.

Likewise, the ACPL-847 is a DC-input quad channel full-pitch phototransistor optocoupler which contains four light emitting diode optically coupled to four separate transistor. It is packaged in a 16-pin DIP package

For both types, it is also available in wide-lead spacing option and lead bend SMD option with input-output isolation voltage at 5000 Vrms. Response time, t_r , is typically 4 μ s and minimum CTR is 50% at input current of 5 mA

ACPL-827 pin layout

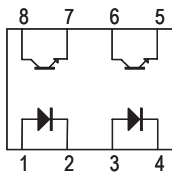

- Pin 1, 3 Anode
- Pin 2, 4 Cathode
- Pin 5, 7 Emitter
- Pin 6, 8 Collector

ACPL-847 pin layout

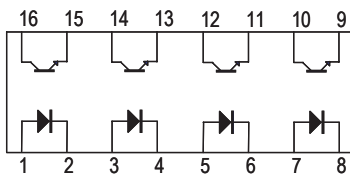

- Pin 1, 3, 5, 7 Anode
- Pin 2, 4, 6, 8 Cathode
- Pin 9, 11, 13, 15 Emitter
- Pin 10, 12, 14, 16 Collector

Features

- Current transfer ratio (CTR: min. 50% at $I_F = 5\text{mA}$, $V_{CE} = 5\text{V}$)
- High input-output isolation voltage ($V_{ISO} = 5,000V_{RMS}$)
- Response time (t_r : typ. 4 μ s at $V_{CE} = 2\text{V}$, $I_C = 2\text{mA}$, $R_L = 100\Omega$)
- Compact dual-in-line package
- Safety and regulatory approvals
 - CSA
 - UL 1577
 - IEC/EN/DIN EN 60747-5-2
- Options available:
 - Leads with 0.4" (10.16 mm) spacing (W00)
 - Lead bend for surface mounting (300)
 - Tape and reel for SMD (500) – available only for ACPL-827
 - IEC/EN/DIN EN 60747-5-2 approved (060)
 - Lead-Free (000E)

Applications

- I/O Interface for Programmable controllers, computers.
- Sequence controllers
- System appliances, measuring instruments
- Signal transmission between circuits of different potentials and impedances.

Ordering Information

ACPL-8x7 is UL Recognized with 5000 Vrms for 1 minute per UL1577 and is approved under CSA Component Acceptance Notice #5, File CA 88324.

Part number	RoHS Compliant Option				Package	No. of Channels	Surface Mount	Gull Wing	Tape & Reel	IEC/EN/DIN EN 60747-5-2	Quantity	
	Rank 'O' 50% <CTR< 600%	Rank 'B' 130% <CTR< 260%	Rank 'C' 200% <CTR< 400%	Rank 'G' 130% <CTR< 400%								
ACPL-827	-000E	-00BE	-00CE		300mil DIP-8						50 pcs per tube	
	-300E	-30BE	-30CE		300mil DIP-8		x	X			50 pcs per tube	
	-500E	-50BE	-50CE		300mil DIP-8		X	X	X		1000 pcs per reel	
	-060E	-06BE	-06CE		300mil DIP-8	Dual				X	50 pcs per tube	
	-360E	-36BE	-36CE		300mil DIP-8		x	X		X	50 pcs per tube	
	-560E	-56BE	-56CE		300mil DIP-8		x	X	X	X	1000 pcs per reel	
	-W00E	-W0BE	-W0CE		400mil DIP-8							50 pcs per tube
	-W60E	-W6BE	-W6CE		400mil DIP-8						X	50 pcs per tube
-000E			-00GE	300mil DIP-16							25 pcs per tube	
-300E			-30GE	300mil DIP-16			X	X			25 pcs per tube	
-060E			-06GE	300mil DIP-16	Quad					X	25 pcs per tube	
-360E			-36GE	300mil DIP-16		X	X		X	25 pcs per tube		
-W00E			-W0GE	400mil DIP-16							25 pcs per tube	
-W60E			-W6GE	400mil DIP-16						X	25 pcs per tube	

To order, choose a part number from the part number column and combine with the desired option from the option column to form an order entry.

Example 1:

ACPL-827-36GE to order product of 300mil DIP-8 Dual Channel DC Gull Wing Surface Mount package in Tube packaging with 130%<CTR<400%, IEC/EN/DIN EN 60747-5-2 Safety Approval and RoHS compliant.

Example 2:

ACPL-847-W00E to order product of 400mil DIP-16 Quad Channel DC package in Tube packaging with 50%<CTR<600% and RoHS compliant.

Option datasheets are available. Contact your Avago sales representative or authorized distributor for information.

Package Outline Drawings

ACPL-827 Package Outline

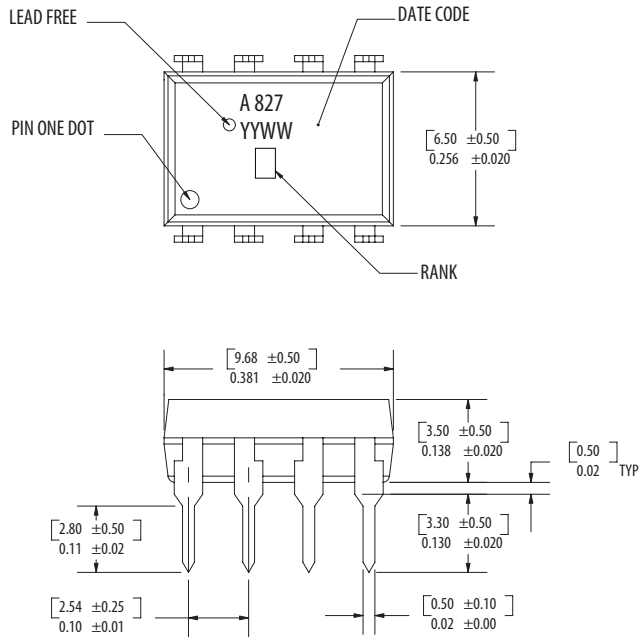

DIMENSIONS IN [MILLIMETERS] AND INCHES

ACPL-827 Package Outline – Option 060

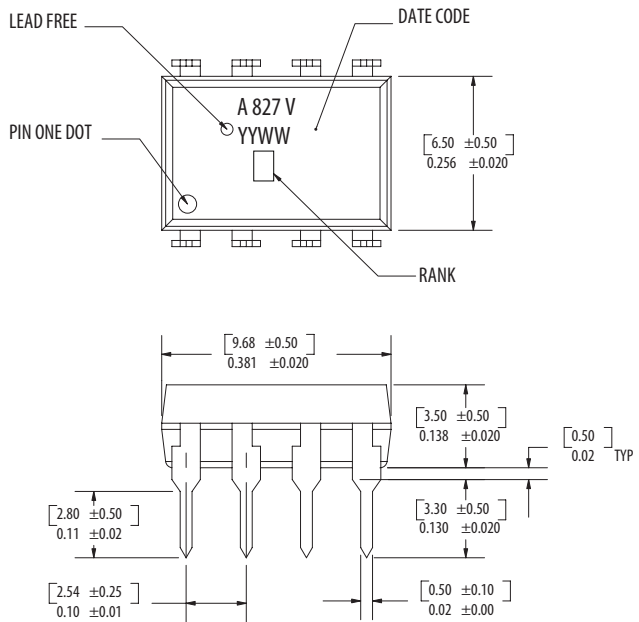

DIMENSIONS IN [MILLIMETERS] AND INCHES

ACPL-827 Package Outline – Option W00

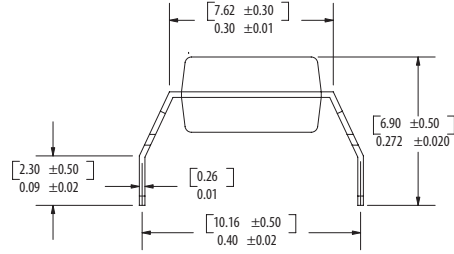
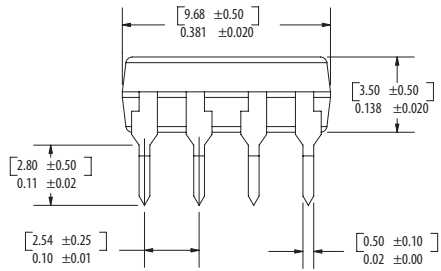
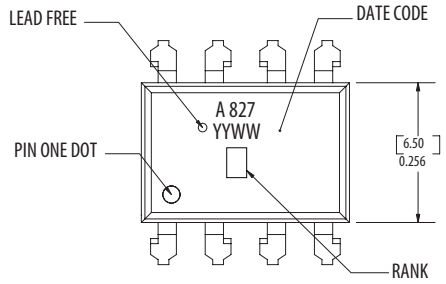

DIMENSIONS IN [MILLIMETERS] AND INCHES

ACPL-827 Package Outline – Option 300

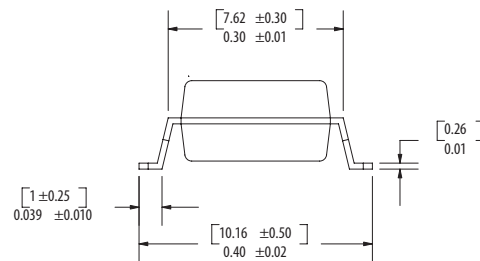
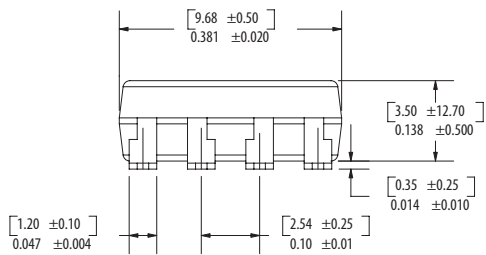
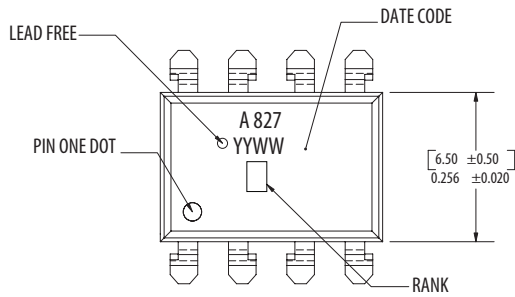

DIMENSIONS IN [MILLIMETERS] AND INCHES

ACPL-847 Package Outline

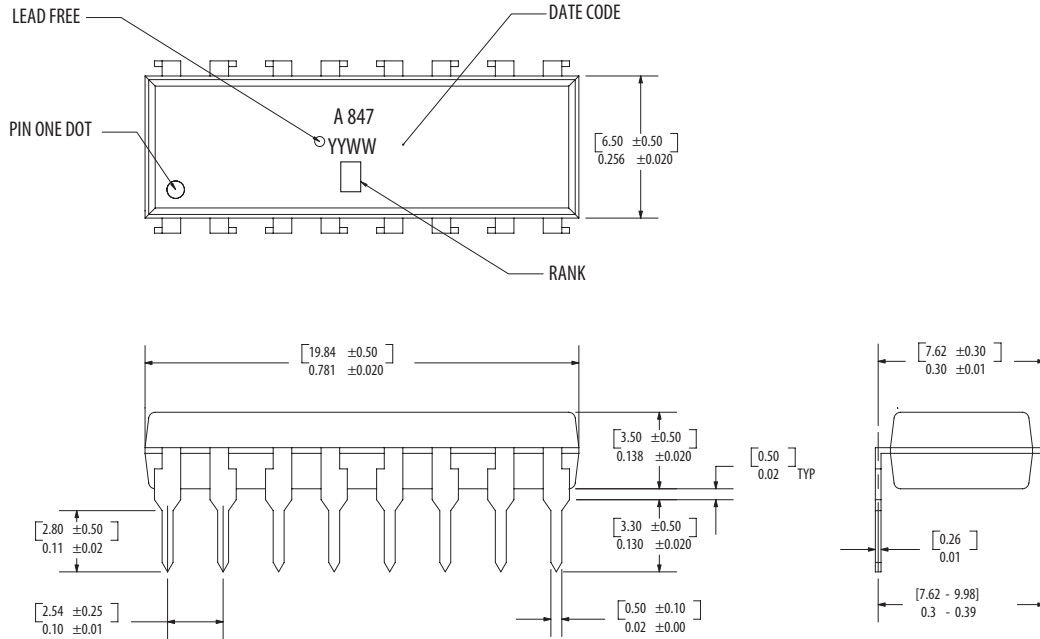

DIMENSIONS IN [MILLIMETERS] AND INCHES

ACPL-847 Package Outline - Option 060

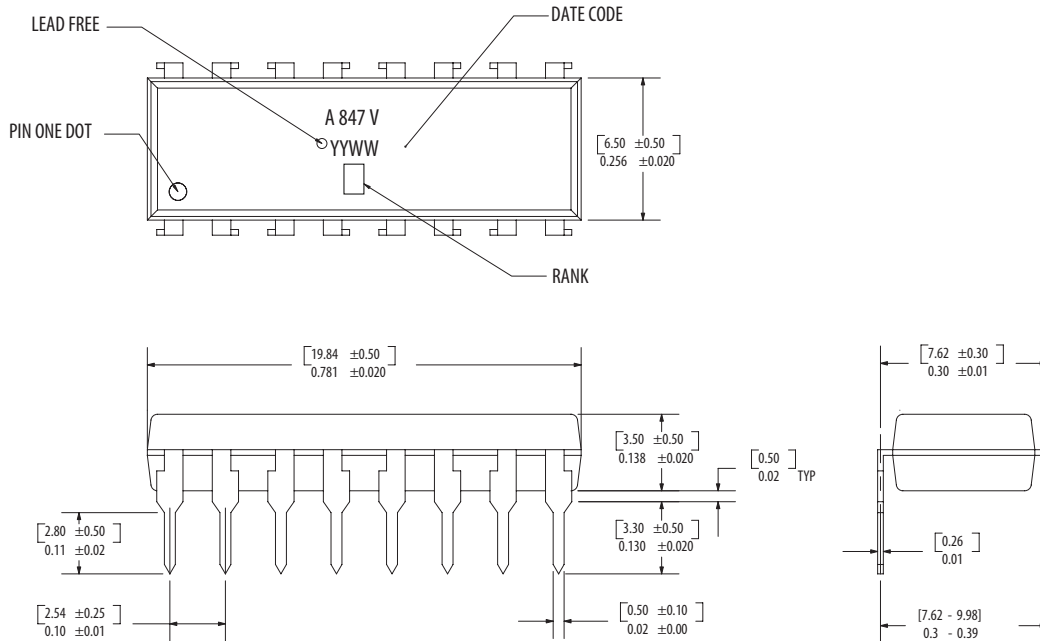

DIMENSIONS IN [MILLIMETERS] AND INCHES

ACPL-847 Package Outline - Option W00

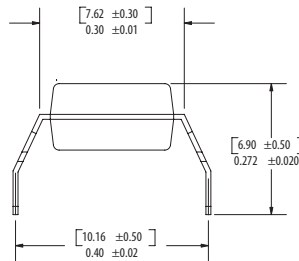
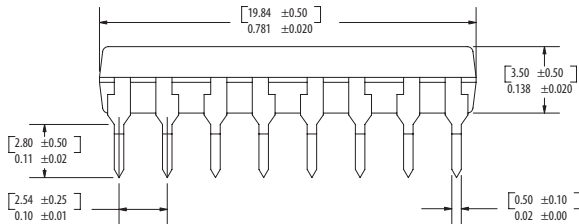
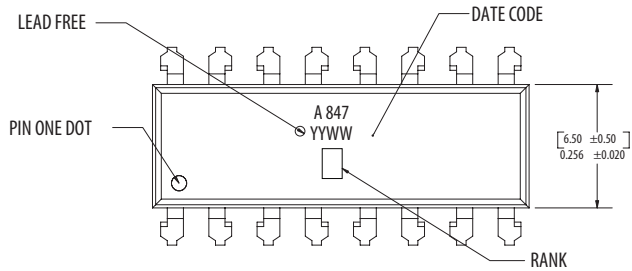

DIMENSIONS IN [MILLIMETERS] AND INCHES

ACPL-847 Package Outline - Option 300

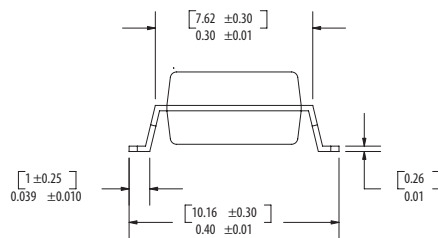
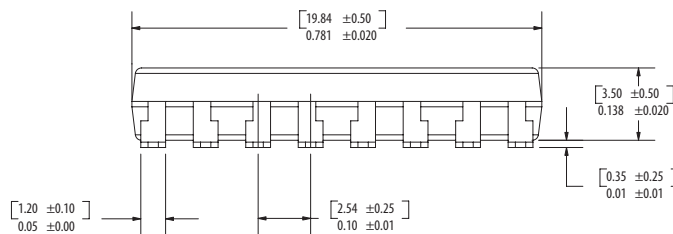
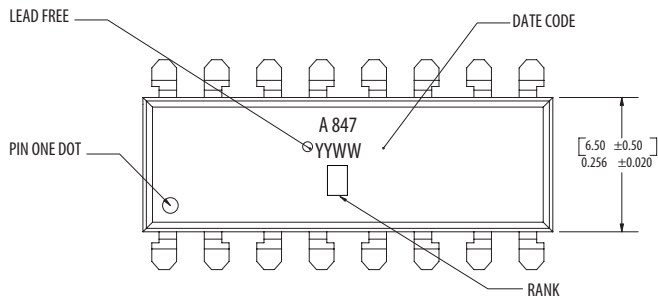

DIMENSIONS IN [MILLIMETERS] AND INCHES

Solder Reflow Temperature Profile

1. One-time soldering reflow is recommended within the condition of temperature and time profile shown at right.
2. When using another soldering method such as infrared ray lamp, the temperature may rise partially in the mold of the device. Keep the temperature on the package of the device within the condition of (1) above.

Note: Non-halide flux should be used.

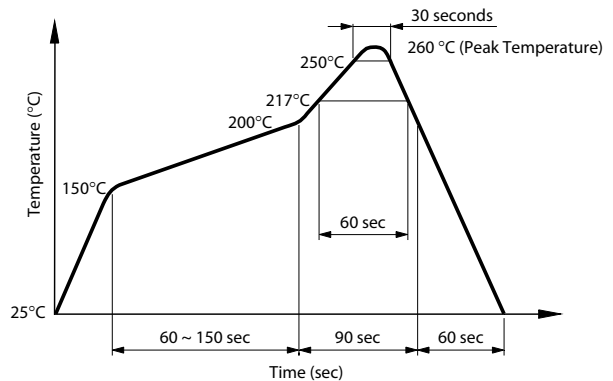

Absolute Maximum Ratings

Parameter	Symbol	Min.	Max.	Units	Note
Storage Temperature	T_S	-55	125	°C	
Operating Temperature	T_A	-30	100	°C	
Average Forward Current	$I_{F(AVG)}$	-	50	mA	
Input Power Dissipation	P_I	-	70	mW	
Input Reverse Voltage	V_R	-	6	V	
Collector Current	I_C	-	50	mA	
Collector-Emitter Voltage	V_{CEO}	-	70	V	
Emitter-Collector Voltage	V_{ECO}	-	6	V	
Isolation Voltage (AC for 1min, R.H. 40~60%)	V_{ISO}	-	5000	V_{RMS}	
Collector Power Dissipation	P_C	-	150	mW	
Total Power Dissipation	P_{TOT}	-	200	mW	
Lead Solder Temperature		260°C for 10 sec., 1.6 mm below seating plane			

Electrical Specifications (DC)

Over recommended operating conditions unless otherwise specified.

Parameter	Symbol	Min.	Typ.	Max.	Units	Test Conditions	Note
Forward Voltage	V_F	-	1.2	1.4	V	$I_F = 20\text{mA}$	
Reverse Current	I_R	-	-	10	μA	$V_R = 4\text{V}$	
Terminal Capacitance	C_t		30	250	pF	$V = 0, f = 1\text{KHz}$	
Collector Dark Current	I_{CEO}		-	100	nA	$V_{CE} = 20\text{V}, I_F = 0\text{mA}$	
Collector-Emitter Breakdown Voltage	BV_{CEO}	70	-	-	V	$I_C = 0.1\text{mA}, I_F = 0\text{mA}$	
Emitter-Collector Breakdown Voltage	BV_{ECO}	6	-	-	V	$I_E = 10\mu\text{A}, I_F = 0\text{mA}$	
Collector Current	I_C	2.5	-	30	mA	$I_F = 5\text{mA}, V_{CE} = 5\text{V}$	$CTR = (I_C/I_F) * 100\%$
Current Transfer Ratio	CTR	50	-	600	%		
Collector-Emitter Saturation Voltage	$V_{CE(sat)}$	-	0.1	0.2	V	$I_F = 20\text{mA}, I_C = 1\text{mA}$	
Isolation Resistance	R_{ISO}	5×10^{10}	1×10^{11}	-	Ω	DC500V, R.H. 40~60%	
Floating Capacitance	C_F	-	0.6	1	pF	$V = 0, f = 1\text{MHz}$	
Cut-off Frequency (-3dB)	F_C	-	80	-	KHz	$V_{CE} = 5\text{V}, I_C = 2\text{mA}, RL = 100\Omega$	See fig 13
Response Time (Rise)	t_r	-	4	18	μs	$V_{CE} = 2\text{V}, I_C = 2\text{mA}, RL = 100\Omega$	See fig 12
Response Time (Fall)	t_f	-	3	18	μs		

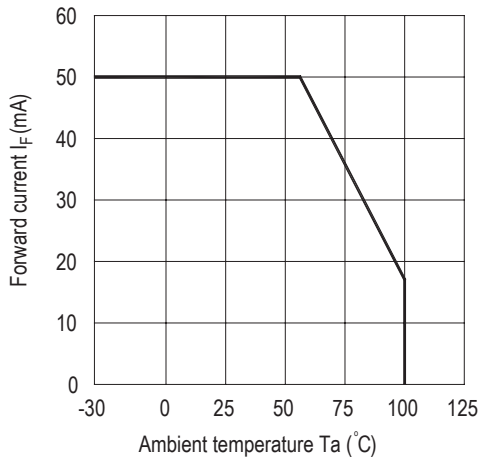

Figure 1. Forward Current vs. Ambient Temperature.

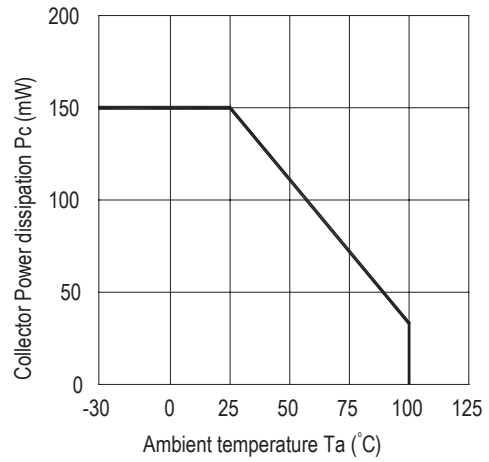

Figure 2 Collector Power Dissipation vs. Ambient Temperature

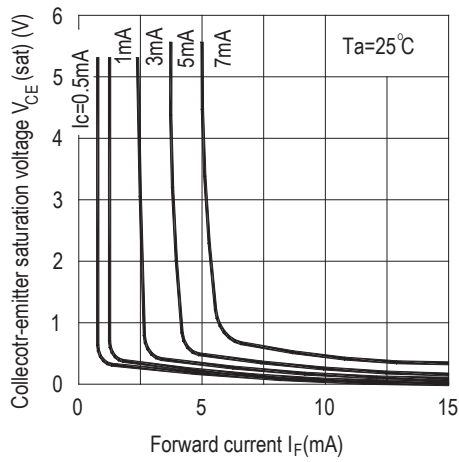

Figure 3. Collector-emitter Saturation Voltage vs. Forward Current

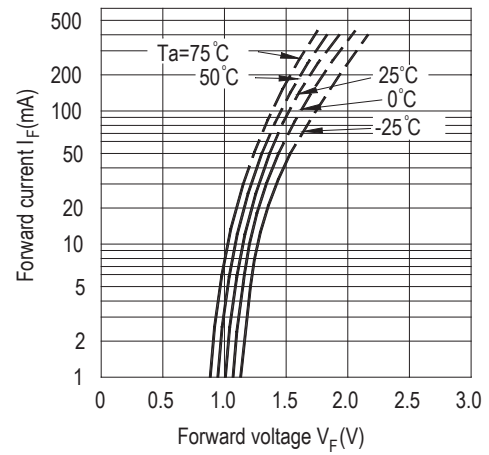

Figure 4. Forward Current vs. Forward Voltage

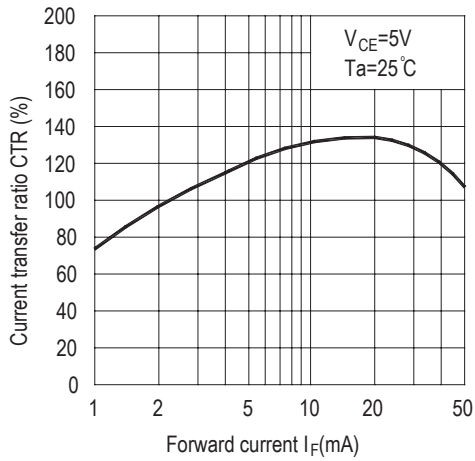

Figure 5. Current Transfer Ratio vs. Forward Current

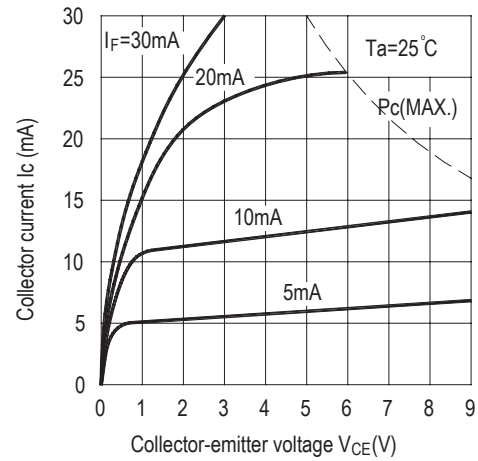

Figure 6. Collector Current vs. Collector-emitter Voltage.

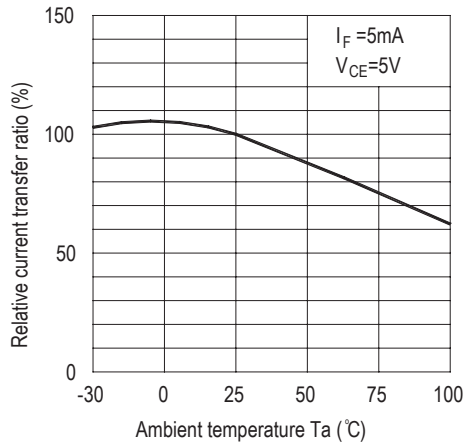

Figure 7. Relative Current Transfer Ratio vs. Ambient Temperature

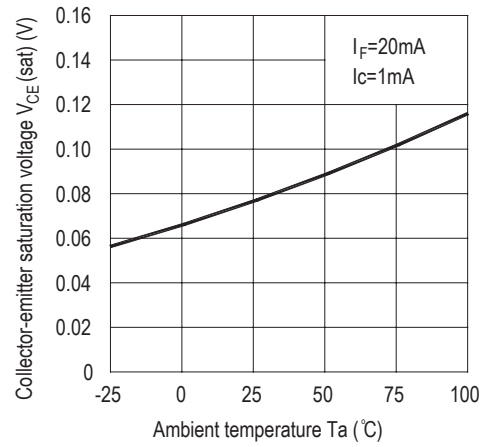

Figure 8. Collector-emitter Saturation Voltage vs. Ambient Temperature

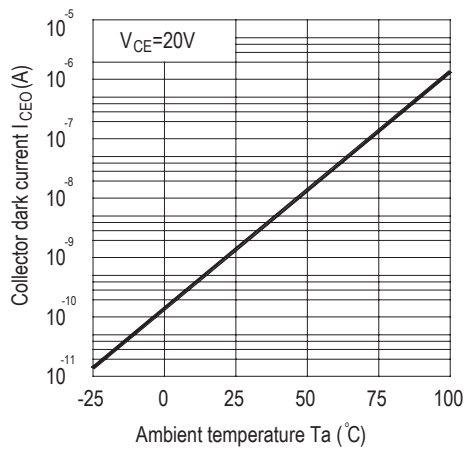

Figure 9. Collector Dark Current vs. Ambient Temperature

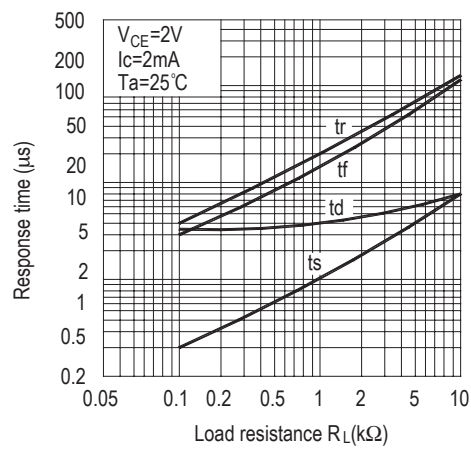

Figure 10. Response Time vs. Load Resistance

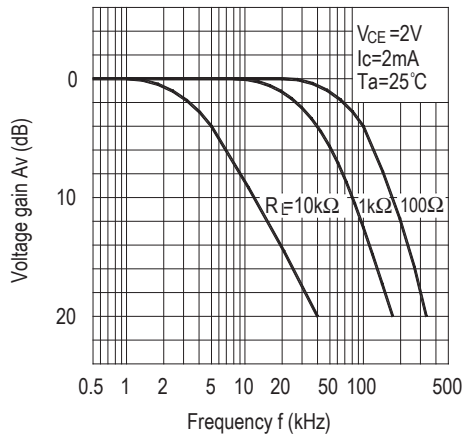

Figure 11. Frequency Response

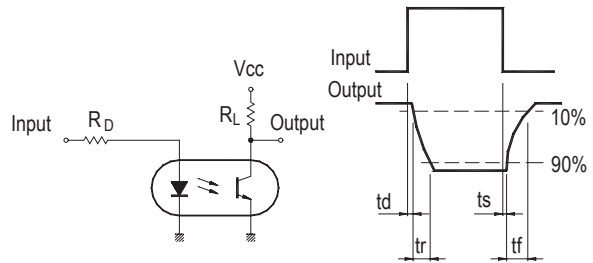

Figure 12. Test Circuit for Response Time

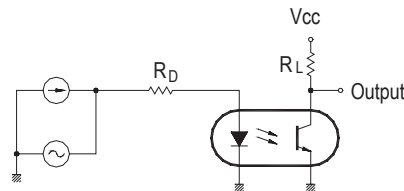

Figure 13. Test Circuit for Frequency Response

For product information and a complete list of distributors, please go to our web site: www.avagotech.com

Avago, Avago Technologies, and the A logo are trademarks of Avago Technologies in the United States and other countries. Data subject to change. Copyright © 2005-2008 Avago Technologies. All rights reserved. Obsoletes AV01-0612EN AV02-1429EN - December 22, 2008

AVAGO
TECHNOLOGIES