

# FOD814 Series, FOD817 Series 4-Pin High Operating Temperature Phototransistor Optocouplers

## Features

- AC input response (FOD814 only)
- Applicable to Pb-free IR reflow soldering
- Compact 4-pin package
- Current transfer ratio in selected groups:
 

FOD814: 20–300%	FOD817: 50–600%
FOD814A: 50–150%	FOD817A: 80–160%
	FOD817B: 130–260%
	FOD817C: 200–400%
	FOD817D: 300–600%
- C-UL, UL and VDE approved
- High input-output isolation voltage of 5000Vrms
- Minimum  $BV_{CEO}$  of 70V guaranteed
- Higher operating temperatures (versus H11AXXX counterparts)

## Applications

### FOD814 Series

- AC line monitor
- Unknown polarity DC sensor
- Telephone line interface

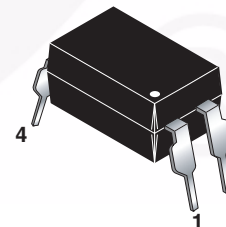
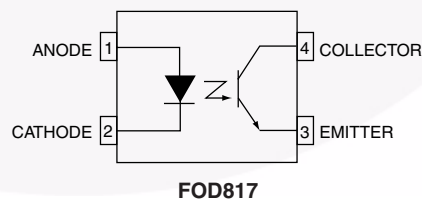
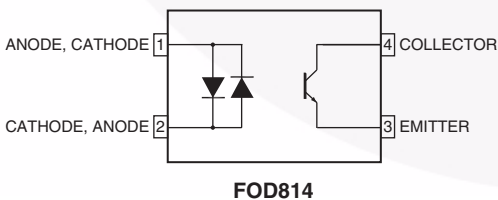
### FOD817 Series

- Power supply regulators
- Digital logic inputs
- Microprocessor inputs

## Description

The FOD814 consists of two gallium arsenide infrared emitting diodes, connected in inverse parallel, driving a silicon phototransistor output in a 4-pin dual in-line package. The FOD817 Series consists of a gallium arsenide infrared emitting diode driving a silicon phototransistor in a 4-pin dual in-line package.

## Functional Block Diagram



**Absolute Maximum Ratings** ( $T_A = 25^\circ\text{C}$  Unless otherwise specified.)

Stresses exceeding the absolute maximum ratings may damage the device. The device may not function or be operable above the recommended operating conditions and stressing the parts to these levels is not recommended. In addition, extended exposure to stresses above the recommended operating conditions may affect device reliability. The absolute maximum ratings are stress ratings only.

Symbol	Parameter	Value		Units
		FOD814	FOD817	
<b>TOTAL DEVICE</b>				
$T_{STG}$	Storage Temperature	-55 to +150		$^\circ\text{C}$
$T_{OPR}$	Operating Temperature	-55 to +105	-55 to +110	$^\circ\text{C}$
$T_{SOL}$	Lead Solder Temperature	260 for 10 sec		$^\circ\text{C}$
$T_J$	Junction Temperature	125 Max.		$^\circ\text{C}$
$\theta_{JC}$	Junction-to-Case Thermal Resistance	210		$^\circ\text{C}/\text{W}$
$P_{TOT}$	Total Power Dissipation	200		mW
<b>EMITTER</b>				
$I_F$	Continuous Forward Current	$\pm 50$	50	mA
$V_R$	Reverse Voltage		6	
$P_D$	Power Dissipation Derate above $100^\circ\text{C}$	70 1.7		mW mW/ $^\circ\text{C}$
<b>DETECTOR</b>				
$V_{CEO}$	Collector-Emitter Voltage	70		V
$V_{ECO}$	Emitter-Collector Voltage	6		V
$I_C$	Continuous Collector Current	50		mA
$P_C$	Collector Power Dissipation Derate above $90^\circ\text{C}$	150 2.9		mW mW/ $^\circ\text{C}$

**Electrical Characteristics** ( $T_A = 25^\circ\text{C}$  Unless otherwise specified.)**Individual Component Characteristics**

Symbol	Parameter	Device	Test Conditions	Min.	Typ.*	Max.	Unit
<b>EMITTER</b>							
$V_F$	Forward Voltage	FOD814	$I_F = \pm 20\text{mA}$		1.2	1.4	V
		FOD817	$I_F = 20\text{mA}$		1.2	1.4	
$I_R$	Reverse Leakage Current	FOD817	$V_R = 4.0\text{V}$			10	$\mu\text{A}$
$C_t$	Terminal Capacitance	FOD814	$V = 0, f = 1\text{kHz}$		50	250	pF
		FOD817	$V = 0, f = 1\text{kHz}$		30	250	
<b>DETECTOR</b>							
$I_{CEO}$	Collector Dark Current	FOD814	$V_{CE} = 20\text{V}, I_F = 0$			100	nA
		FOD817	$V_{CE} = 20\text{V}, I_F = 0$			100	
$BV_{CEO}$	Collector-Emitter Breakdown Voltage	FOD814	$I_C = 0.1\text{mA}, I_F = 0$	70			V
		FOD817	$I_C = 0.1\text{mA}, I_F = 0$	70			
$BV_{ECO}$	Emitter-Collector Breakdown Voltage	FOD814	$I_E = 10\mu\text{A}, I_F = 0$	6			V
		FOD817	$I_E = 10\mu\text{A}, I_F = 0$	6			

**DC Transfer Characteristics**

Symbol	DC Characteristic	Device	Test Conditions	Min.	Typ.*	Max.	Unit
CTR	Current Transfer Ratio	FOD814	$I_F = \pm 1\text{mA}, V_{CE} = 5\text{V}^{(1)}$	20		300	%
		FOD814A		50		150	
		FOD817	$I_F = 5\text{mA}, V_{CE} = 5\text{V}^{(1)}$	50		600	
		FOD817A		80		160	
		FOD817B		130		260	
		FOD817C		200		400	
		FOD817D		300		600	
$V_{CE(sat)}$	Collector-Emitter Saturation Voltage	FOD814	$I_F = \pm 20\text{mA}, I_C = 1\text{mA}$		0.1	0.2	V
		FOD817	$I_F = 20\text{mA}, I_C = 1\text{mA}$		0.1	0.2	

**AC Transfer Characteristics**

Symbol	AC Characteristic	Device	Test Conditions	Min.	Typ.*	Max.	Unit
$f_C$	Cut-Off Frequency	FOD814	$V_{CE} = 5\text{V}, I_C = 2\text{mA}, R_L = 100\Omega, -3\text{dB}$	15	80		kHz
$t_r$	Response Time (Rise)	FOD814, FOD817	$V_{CE} = 2\text{V}, I_C = 2\text{mA}, R_L = 100\Omega^{(2)}$		4	18	$\mu\text{s}$
$t_f$	Response Time (Fall)	FOD814, FOD817			3	18	$\mu\text{s}$

\*Typical values at  $T_A = 25^\circ\text{C}$

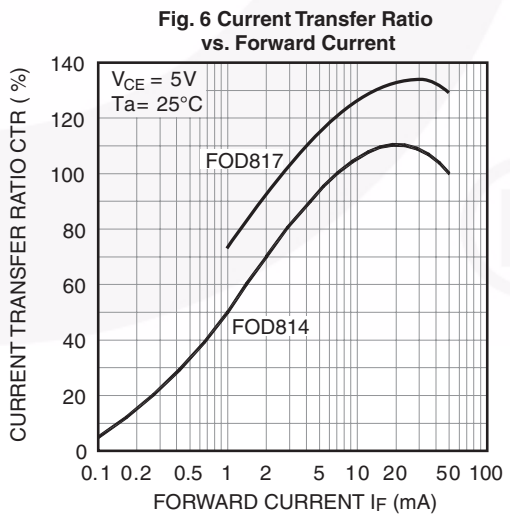
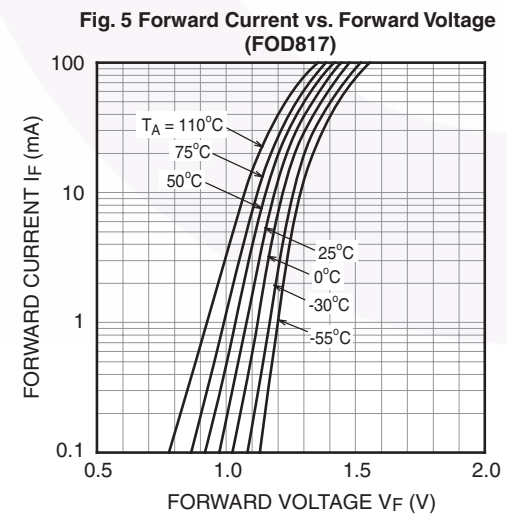
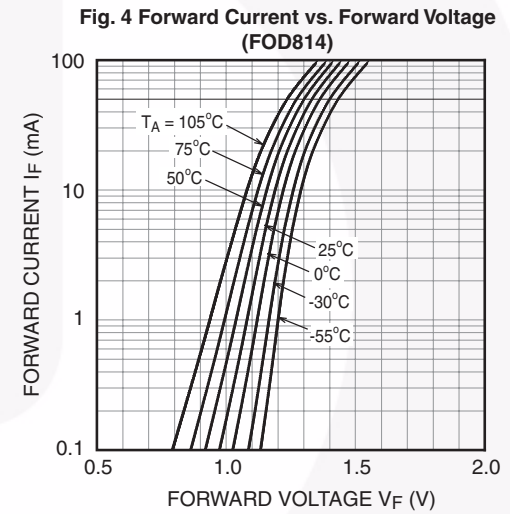
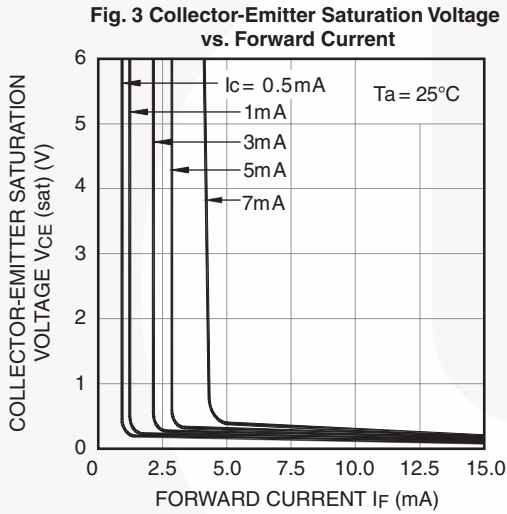
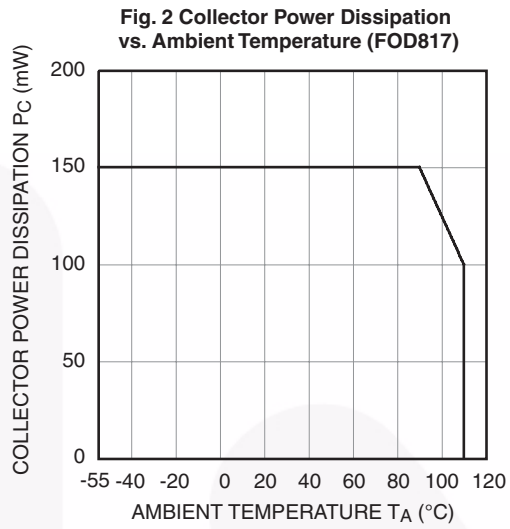
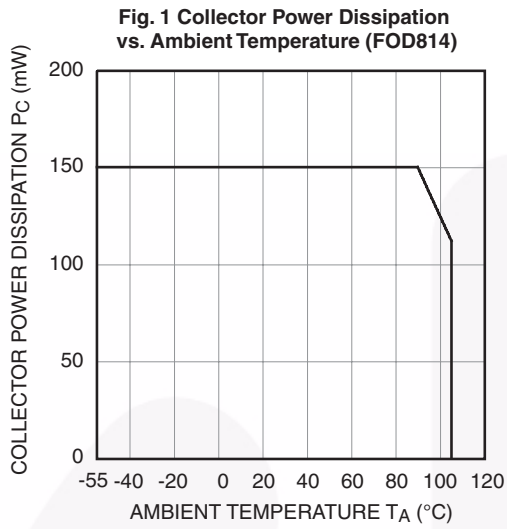
**Electrical Characteristics** ( $T_A = 25^\circ\text{C}$  Unless otherwise specified.) (Continued)**Isolation Characteristics**

Symbol	Characteristic	Device	Test Conditions	Min.	Typ.*	Max.	Units
$V_{ISO}$	Input-Output Isolation Voltage <sup>(3)</sup>	FOD814, FOD817	$f = 60\text{Hz}$ , $t = 1 \text{ min}$ , $I_{I-O} \leq 2\mu\text{A}$	5000			Vac(rms)
$R_{ISO}$	Isolation Resistance	FOD814, FOD817	$V_{I-O} = 500\text{VDC}$	$5 \times 10^{10}$	$1 \times 10^{11}$		$\Omega$
$C_{ISO}$	Isolation Capacitance	FOD814, FOD817	$V_{I-O} = 0$ , $f = 1 \text{ MHz}$		0.6	1.0	pf

\*Typical values at  $T_A = 25^\circ\text{C}$ **Notes:**

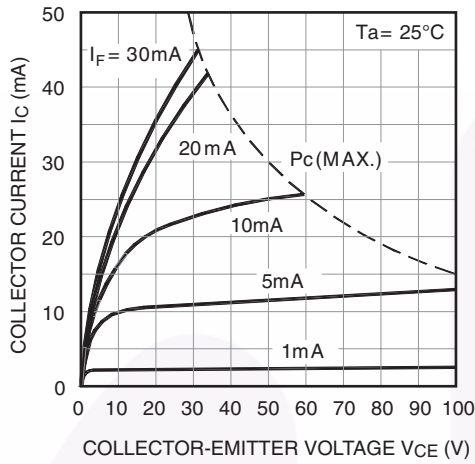
1. Current Transfer Ratio (CTR) =  $I_C/I_F \times 100\%$ .
2. For test circuit setup and waveforms, refer to page 7.
3. For this test, Pins 1 and 2 are common, and Pins 3 and 4 are common.

**Typical Electrical/Optical Characteristics** ( $T_A = 25^\circ\text{C}$  Unless otherwise specified.)

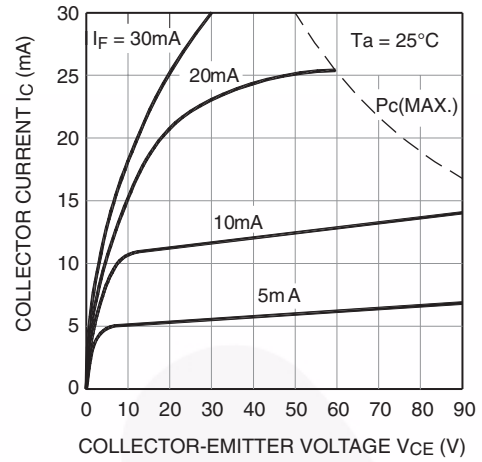


**Typical Electrical/Optical Characteristics** (Continued) ( $T_A = 25^\circ\text{C}$  Unless otherwise specified.)

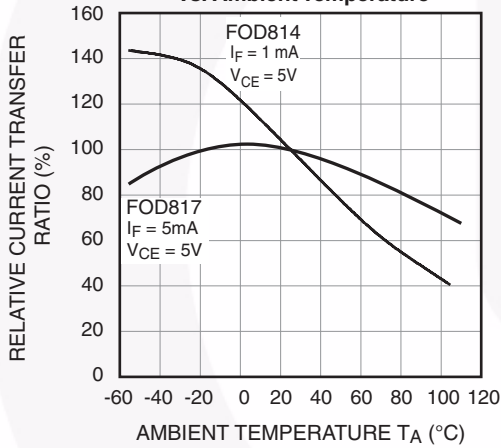
**Fig. 7 Collector Current vs. Collector-Emitter Voltage (FOD814)**



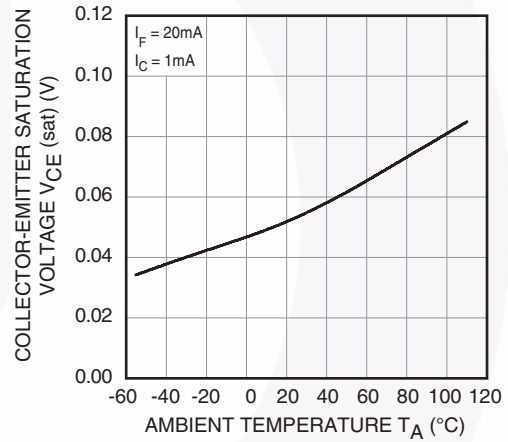
**Fig. 8 Collector Current vs. Collector-Emitter Voltage (FOD817)**



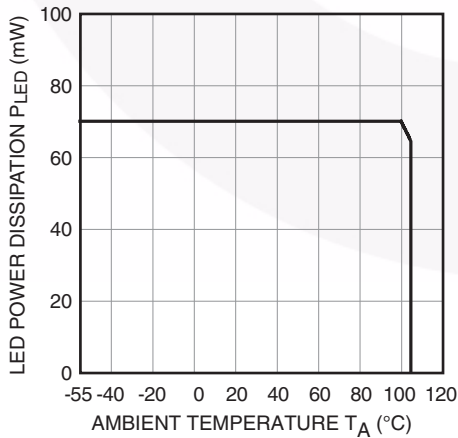
**Fig. 9 Relative Current Transfer Ratio vs. Ambient Temperature**



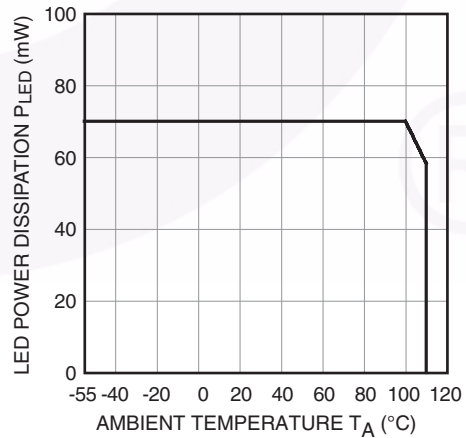
**Fig. 10 Collector-Emitter Saturation Voltage vs. Ambient Temperature**



**Fig. 11 LED Power Dissipation vs. Ambient Temperature (FOD814)**

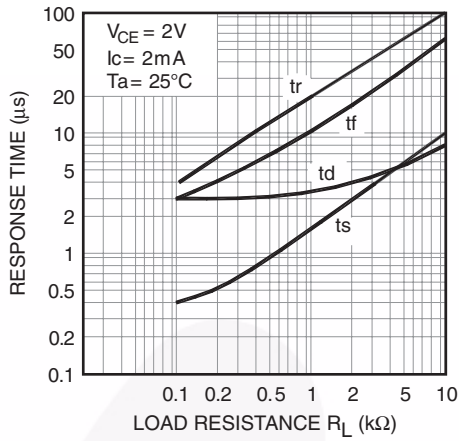


**Fig. 12 LED Power Dissipation vs. Ambient Temperature (FOD817)**

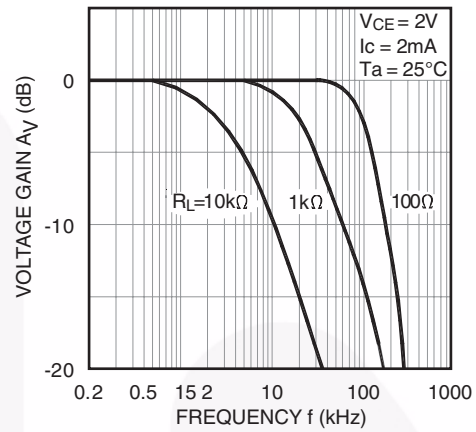


**Typical Electrical/Optical Characteristics** (Continued) ( $T_A = 25^\circ\text{C}$  Unless otherwise specified.)

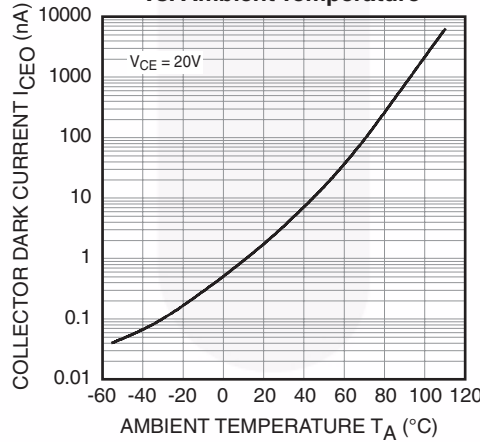
**Fig. 13 Response Time vs. Load Resistance**



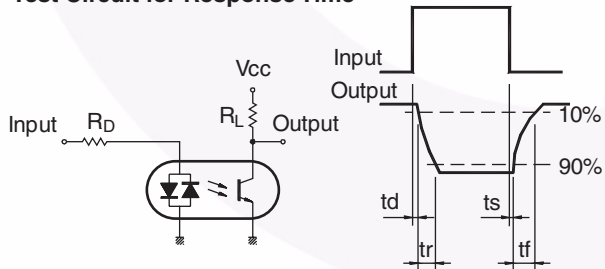
**Fig. 14 Frequency Response**



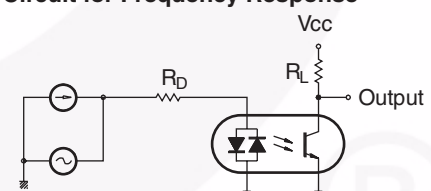
**Fig. 15 Collector Dark Current vs. Ambient Temperature**



**Test Circuit for Response Time**

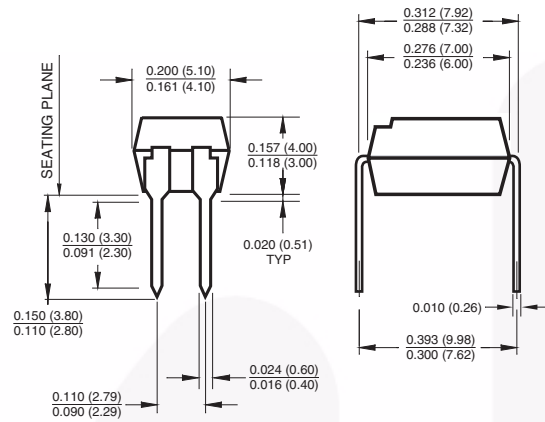


**Test Circuit for Frequency Response**

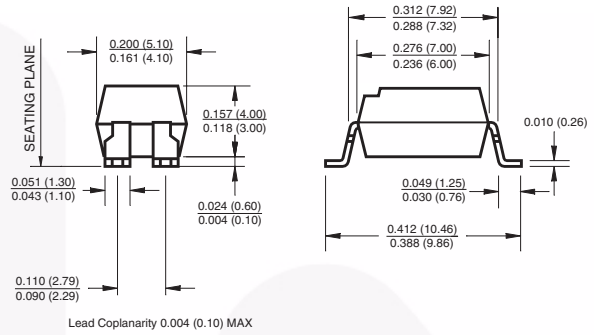


## Package Dimensions

### Through Hole

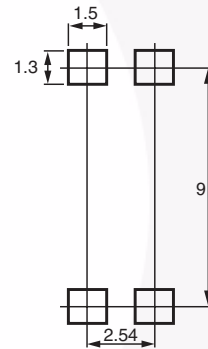
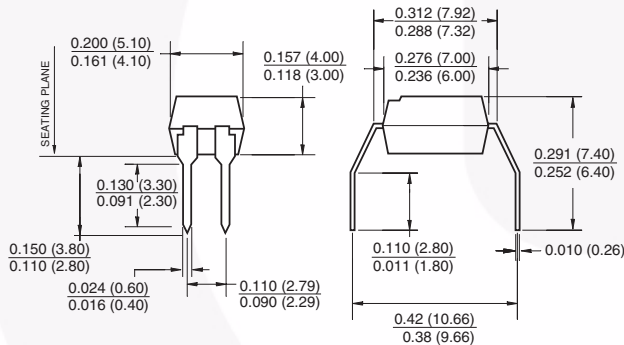


### Surface Mount



### Surface Mount (Footprint Dimensions)

### 0.4" Lead Spacing



### Note:

All dimensions are in inches (millimeters)

Package drawings are provided as a service to customers considering Fairchild components. Drawings may change in any manner without notice. Please note the revision and/or date on the drawing and contact a Fairchild Semiconductor representative to verify or obtain the most recent revision. Package specifications do not expand the terms of Fairchild's worldwide terms and conditions, specifically the warranty therein, which covers Fairchild products.

Always visit Fairchild Semiconductor's online packaging area for the most recent package drawings:

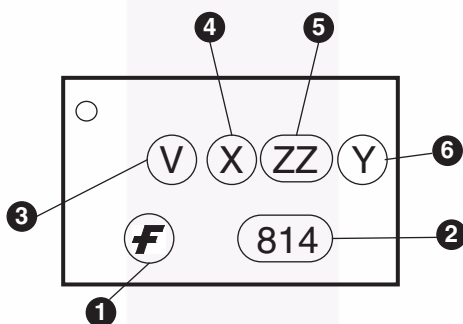
<http://www.fairchildsemi.com/packaging/>



## Ordering Information

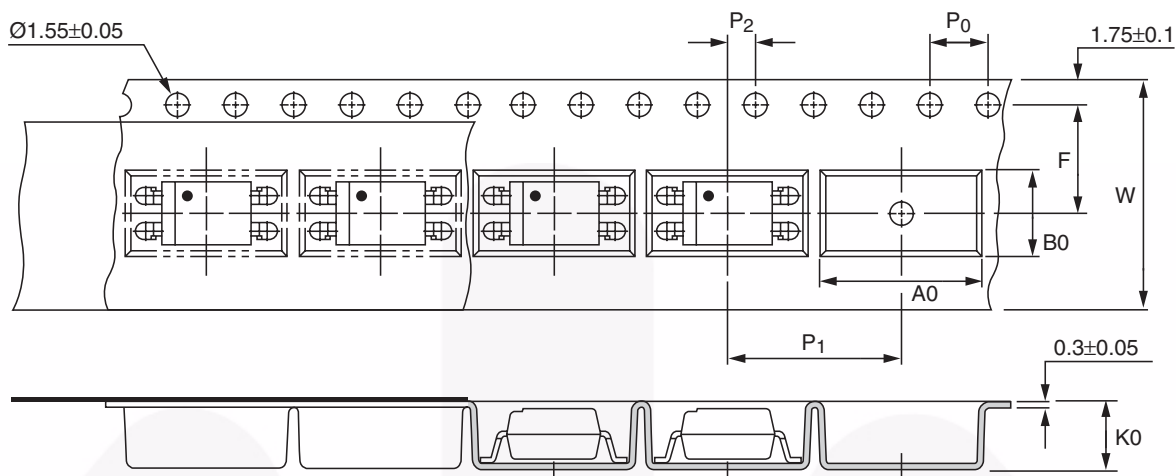
Option	Part Number Example	Description
S	FOD814S	Surface Mount Lead Bend
SD	FOD814SD	Surface Mount; Tape and reel
300	FOD814300	VDE Approved
300W	FOD814300W	VDE Approved, 0.4" Lead Spacing
3S	FOD8143S	VDE Approved, Surface Mount
3SD	FOD8143SD	VDE Approved, Surface Mount, Tape & Reel

## Marking Information



Definitions	
1	Fairchild logo
2	Device number
3	VDE mark (Note: Only appears on parts ordered with VDE option – See order entry table)
4	One digit year code
5	Two digit work week ranging from '01' to '53'
6	Assembly package code

### Carrier Tape Specifications

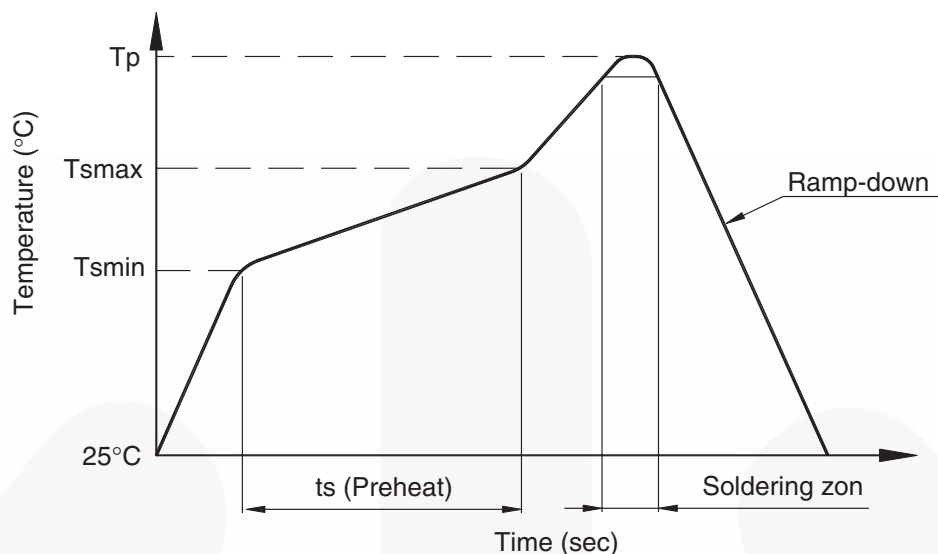


**Note:**

All dimensions are in millimeters.

Symbol	Description	Dimensions in mm (inches)
W	Tape wide	$16 \pm 0.3$ (.63)
$P_0$	Pitch of sprocket holes	$4 \pm 0.1$ (.15)
F $P_2$	Distance of compartment	$7.5 \pm 0.1$ (.295) $2 \pm 0.1$ (.079)
$P_1$	Distance of compartment to compartment	$12 \pm 0.1$ (.472)
A0	Compartment	$10.45 \pm 0.1$ (.411)
B0		$5.30 \pm 0.1$ (.209)
K0		$4.25 \pm 0.1$ (.167)

### Lead Free Recommended IR Reflow Condition



Profile Feature	Pb-Sn solder assembly	Lead Free assembly
Preheat condition (Tsmín-Tsmáx / ts)	100°C ~ 150°C 60 ~ 120 sec	150°C ~ 200°C 60 ~ 120 sec
Melt soldering zone	183°C 60 ~ 120 sec	217°C 30 ~ 90 sec
Peak temperature (Tp)	240 +0/-5°C	260 +0/-5°C
Ramp-down rate	6°C/sec max.	6°C/sec max.






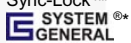
### Recommended Wave Soldering condition

Profile Feature	For all solder assembly
Peak temperature (Tp)	Max 260°C for 10 sec



**TRADEMARKS**

The following includes registered and unregistered trademarks and service marks, owned by Fairchild Semiconductor and/or its global subsidiaries, and is not intended to be an exhaustive list of all such trademarks.

- |  |   |  |   |
|--|---|--|---|
| Auto-SPM™  | F-PFS™  | PowerTrench®   | The Power Franchise®  |
| Build it Now™  | FRFET®  | PowerXS™   | the power franchise   |
| CorePLUS™  | Global Power Resource SM  | Programmable Active Droop™   | TinyBoost™  |
| CorePOWER™   | Green FPS™  | QFET®  | TinyBuck™   |
| CROSSVOLT™   | Green FPS™ e-Series™  | QS™  | TinyLogic®  |
| CTL™   | Gmax™   | Quiet Series™  | TINYOPTO™   |
| Current Transfer Logic™  | GTO™  | RapidConfigure™  | TinyPower™  |
| EcoSPARK®  | IntelliMAX™   |  ™  | TinyPWM™  |
| EfficientMax™  | ISOPLANAR™  | Saving our world, 1mW/W/kW at a time™  | TinyWire™   |
| EZSWITCH™*   | MegaBuck™   | SmartMax™  | TriFault Detect™  |
|  ™* | MICROCOUPLER™   | SMART START™   | TRUECURRENT™*   |
|  ®  | MicroFET™   | SPM®   | µSerDes™  |
| Fairchild®   | MicroPak™   | STEALTH™   |  ™ |
| Fairchild Semiconductor®   | MillerDrive™  | SuperFET™  | UHC®  |
| FACT Quiet Series™   | MotionMax™  | SuperSOT™.3  | Ultra FRFET™  |
| FACT®  | Motion-SPM™   | SuperSOT™.6  | UniFET™   |
| FAST®  | OPTOLOGIC®  | SuperSOT™.8  | VCX™  |
| FastvCore™   | OPTOPLANAR®   | SupreMOS™  | VisualMax™  |
| FETBench™  |  ™ | SyncFET™   | XS™   |
| FlashWriter®*  | PDP SPM™  | Sync-Lock™   |   |
| FPS™   | Power-SPM™  |  ™* |   |

\* Trademarks of System General Corporation, used under license by Fairchild Semiconductor.

**DISCLAIMER**

FAIRCHILD SEMICONDUCTOR RESERVES THE RIGHT TO MAKE CHANGES WITHOUT FURTHER NOTICE TO ANY PRODUCTS HEREIN TO IMPROVE RELIABILITY, FUNCTION, OR DESIGN. FAIRCHILD DOES NOT ASSUME ANY LIABILITY ARISING OUT OF THE APPLICATION OR USE OF ANY PRODUCT OR CIRCUIT DESCRIBED HEREIN; NEITHER DOES IT CONVEY ANY LICENSE UNDER ITS PATENT RIGHTS, NOR THE RIGHTS OF OTHERS. THESE SPECIFICATIONS DO NOT EXPAND THE TERMS OF FAIRCHILD'S WORLDWIDE TERMS AND CONDITIONS, SPECIFICALLY THE WARRANTY THEREIN, WHICH COVERS THESE PRODUCTS.

**LIFE SUPPORT POLICY**

FAIRCHILD'S PRODUCTS ARE NOT AUTHORIZED FOR USE AS CRITICAL COMPONENTS IN LIFE SUPPORT DEVICES OR SYSTEMS WITHOUT THE EXPRESS WRITTEN APPROVAL OF FAIRCHILD SEMICONDUCTOR CORPORATION.

As used herein:

- Life support devices or systems are devices or systems which, (a) are intended for surgical implant into the body or (b) support or sustain life, and (c) whose failure to perform when properly used in accordance with instructions for use provided in the labeling, can be reasonably expected to result in a significant injury of the user.
- A critical component in any component of a life support, device, or system whose failure to perform can be reasonably expected to cause the failure of the life support device or system, or to affect its safety or effectiveness.

**ANTI-COUNTERFEITING POLICY**

Fairchild Semiconductor Corporation's Anti-Counterfeiting Policy. Fairchild's Anti-Counterfeiting Policy is also stated on our external website, [www.fairchildsemi.com](http://www.fairchildsemi.com), under Sales Support.

Counterfeiting of semiconductor parts is a growing problem in the industry. All manufacturers of semiconductor products are experiencing counterfeiting of their parts. Customers who inadvertently purchase counterfeit parts experience many problems such as loss of brand reputation, substandard performance, failed applications, and increased cost of production and manufacturing delays. Fairchild is taking strong measures to protect ourselves and our customers from the proliferation of counterfeit parts. Fairchild strongly encourages customers to purchase Fairchild parts either directly from Fairchild or from Authorized Fairchild Distributors who are listed by country on our web page cited above. Products customers buy either from Fairchild directly or from Authorized Fairchild Distributors are genuine parts, have full traceability, meet Fairchild's quality standards for handling and storage and provide access to Fairchild's full range of up-to-date technical and product information. Fairchild and our Authorized Distributors will stand behind all warranties and will appropriately address any warranty issues that may arise. Fairchild will not provide any warranty coverage or other assistance for parts bought from Unauthorized Sources. Fairchild is committed to combat this global problem and encourage our customers to do their part in stopping this practice by buying direct or from authorized distributors.

**PRODUCT STATUS DEFINITIONS**

**Definition of Terms**

Datasheet Identification	Product Status	Definition
Advance Information	Formative / In Design	Datasheet contains the design specifications for product development. Specifications may change in any manner without notice.
Preliminary	First Production	Datasheet contains preliminary data; supplementary data will be published at a later date. Fairchild Semiconductor reserves the right to make changes at any time without notice to improve design.
No Identification Needed	Full Production	Datasheet contains final specifications. Fairchild Semiconductor reserves the right to make changes at any time without notice to improve the design.
Obsolete	Not In Production	Datasheet contains specifications on a product that is discontinued by Fairchild Semiconductor. The datasheet is for reference information only.

Rev. I40