



Parameter	Rating	Units
Blocking Voltage	350	V _p
Load Current	120	mA
Max R _{ON}	35	Ω
Input Control Current	0.25	mA

Features

- Lowest Available Input Control Current (0.25mA)
- Small 6 Pin DIP Package
- Low Drive Power Requirements (TTL/CMOS Compatible)
- No Moving Parts
- High Reliability
- Arc-Free With No Snubbing Circuits
- 3750V_{rms} Input/Output Isolation
- No EMI/RFI Generation
- Machine Insertable, Wave Solderable
- Surface Mount, Tape & Reel Version Available

Applications

- Telecommunications
 - Telecom Switching
 - Tip/Ring Circuits
 - Modem Switching (Laptop, Notebook, PocketSize)
 - Hook Switch
 - Dial Pulsing
 - Ground Start
 - Ringing Injection
- Instrumentation
 - Multiplexers
 - Data Acquisition
 - Electronic Switching
 - I/O Subsystems
 - Meters (Watt-Hour, Water, Gas)
- Medical Equipment Patient/Equipment Isolation
- Aerospace
- Industrial Controls

Description

The LCA182 is a 1-Form-A solid state relay that uses optically coupled MOSFET technology to provide 3750V_{rms} of input to output isolation. It features an extremely low input control current of only 0.25mA, the lowest available in the Clare Solid State Relay Family. The efficient MOSFET switches and photovoltaic die use Clare's patented OptoMOS architecture. The optically coupled output is controlled by a highly efficient GaAIAs infrared LED. The LCA182 can be used to replace mechanical relays and offers the superior reliability associated with semiconductor devices. Because they have no moving parts, they offer faster, bounce-free switching in a more compact surface mount or through-hole package.

Approvals

- UL Recognized Component: File # E76270
- CSA Certified Component: Certificate # 1175739
- EN/IEC 60950 Compliant

Ordering Information

Part #	Description
LCA182	6 Pin DIP (50/Tube)
LCA182S	6 Pin Surface Mount (50/Tube)
LCA182STR	6 Pin Surface Mount (1000/Reel)

Pin Configuration

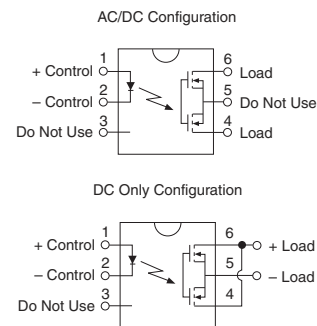

Switching Characteristics of Normally Open (Form A) Devices

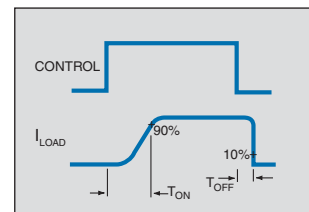

Absolute Maximum Ratings (@ 25°C)

Parameter	Ratings	Units
Blocking Voltage	350	V _P
Reverse Input Voltage	5	V
Input Control Current	50	mA
Peak (10ms)	1	A
Input Power Dissipation ¹	150	mW
Total Power Dissipation ²	800	mW
Isolation Voltage, Input to Output	3750	V _{rms}
Operational Temperature	-40 to +85	°C
Storage Temperature	-40 to +125	°C

¹ Derate Linearly 1.33 mW/°C

² Derate Linearly 6.67 mW/°C

Absolute Maximum Ratings are stress ratings. Stresses in excess of these ratings can cause permanent damage to the device. Functional operation of the device at conditions beyond those indicated in the operational sections of this data sheet is not implied.

Electrical Characteristics

Parameter	Conditions	Symbol	Min	Typ	Max	Units
Output Characteristics @ 25°C						
Load Current, Continuous						
AC/DC Configuration	-	I _L	-	-	120	mA
DC Configuration					200	
Peak Load Current	t=10ms	I _{LPK}	-	-	350	mA
On-Resistance						
AC/DC Configuration	I _L =120mA	R _{ON}	-	23	35	Ω
DC Configuration	I _L =200mA			7	10	
Off-State Leakage Current	V _L =350V	I _{LEAK}	-	-	1	μA
Switching Speeds						
Turn-On	I _F =1mA, V _L =10V	t _{ON}	-	-	3	ms
Turn-Off		t _{OFF}	-	-	3	
Output Capacitance	50V; f=1MHz	C _{OUT}	-	25	-	pF
Input Characteristics @ 25°C						
Input Control Current ¹	I _L =120mA	I _F	-	-	0.25	mA
Input Dropout Current	-	I _F	0.05	-	-	mA
Input Voltage Drop	I _F =1mA	V _F	0.9	1.2	1.4	V
Reverse Input Current	V _R =5V	I _R	-	-	10	μA
Common Characteristics @ 25°C						
Input to Output Capacitance	-	C _{I/O}	-	3	-	pF

¹ It is recommended that the input control current be increased to 1mA in high temperature (>55°C) operation.

PERFORMANCE DATA*

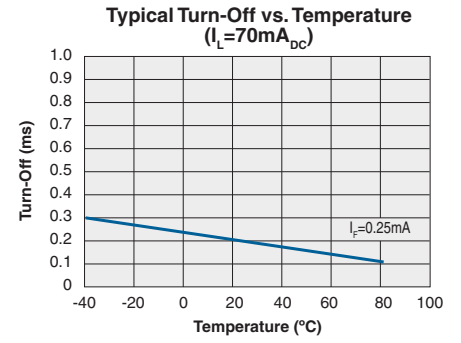
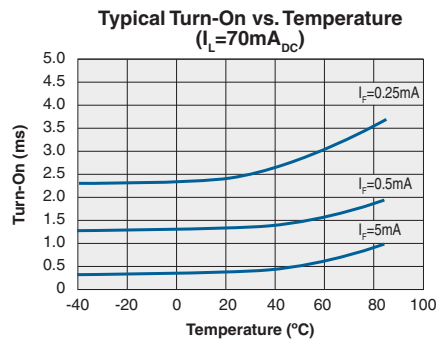
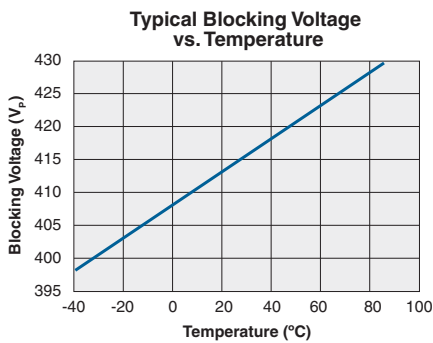
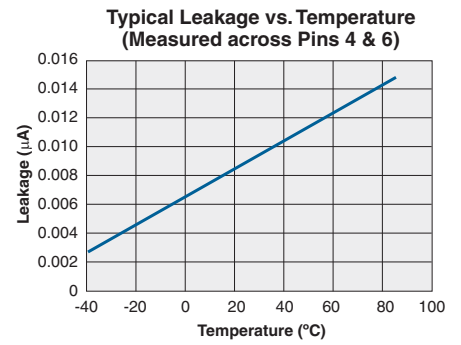
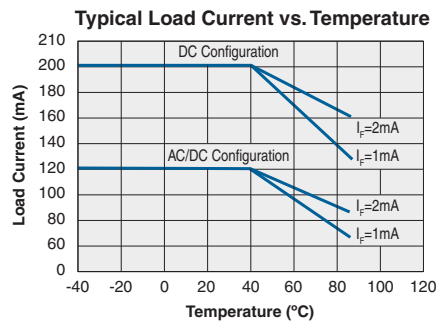
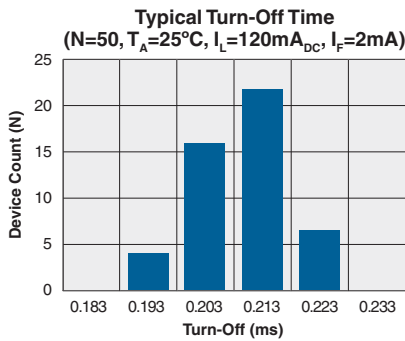
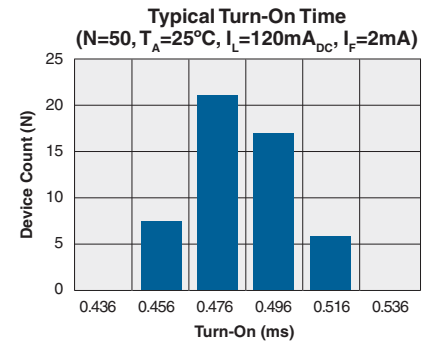
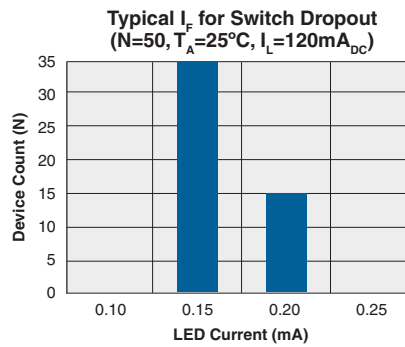
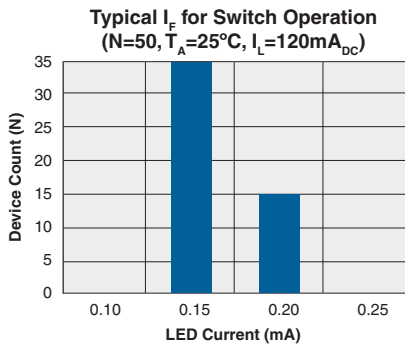
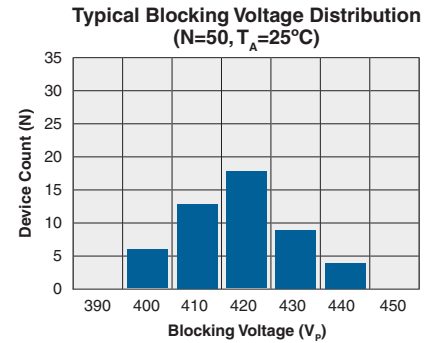
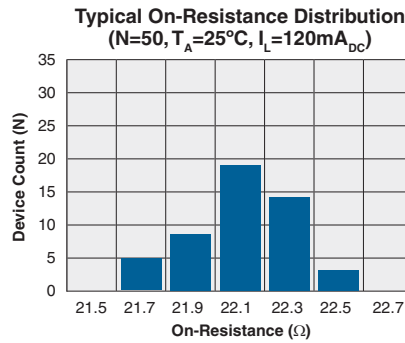
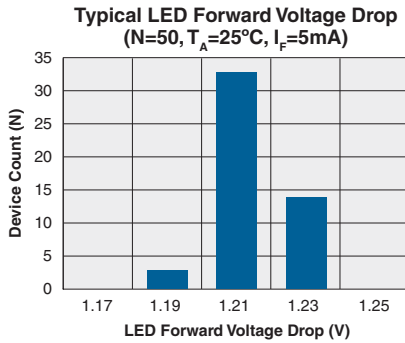

*The Performance data shown in the graphs above is typical of device performance. For guaranteed parameters not indicated in the written specifications, please contact our application department.

PERFORMANCE DATA*

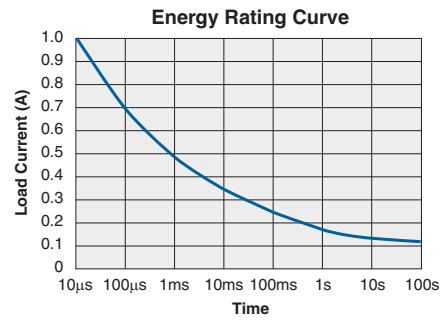
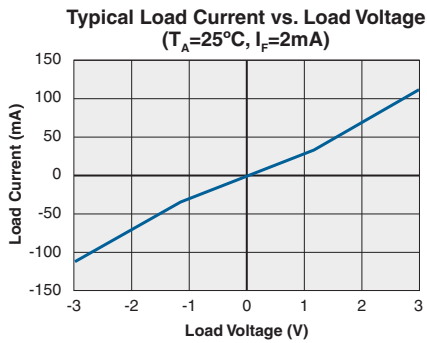
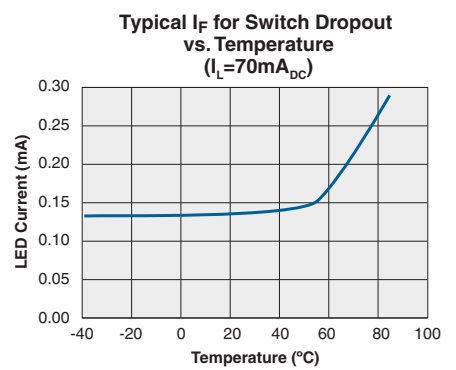
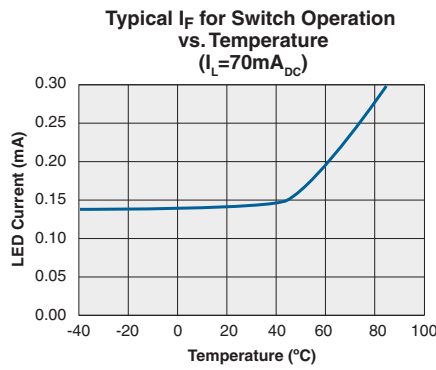
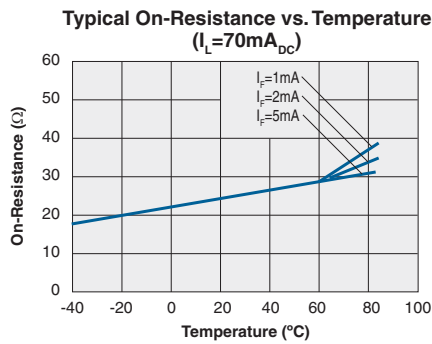
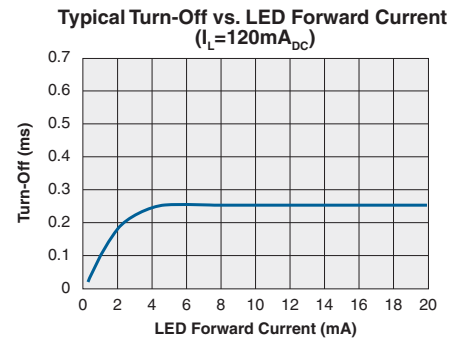
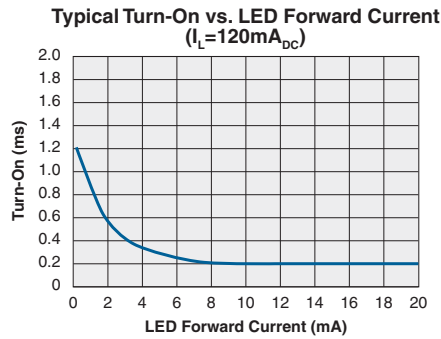
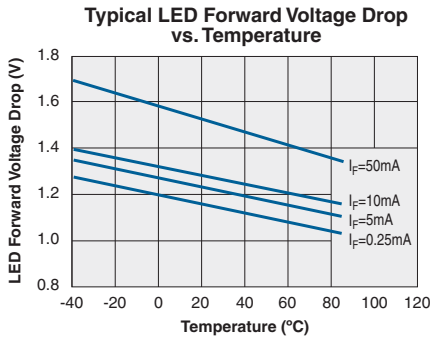

*The Performance data shown in the graphs above is typical of device performance. For guaranteed parameters not indicated in the written specifications, please contact our application department.

Manufacturing Information

Soldering

For proper assembly, the component must be processed in accordance with the current revision of IPC/JEDEC standard J-STD-020. Failure to follow the recommended guidelines may cause permanent damage to the device resulting in impaired performance and/or a reduced lifetime expectancy.

Washing

Clare does not recommend ultrasonic cleaning or the use of chlorinated solvents.



MECHANICAL DIMENSIONS

6-Pin DIP Thru-Hole Package

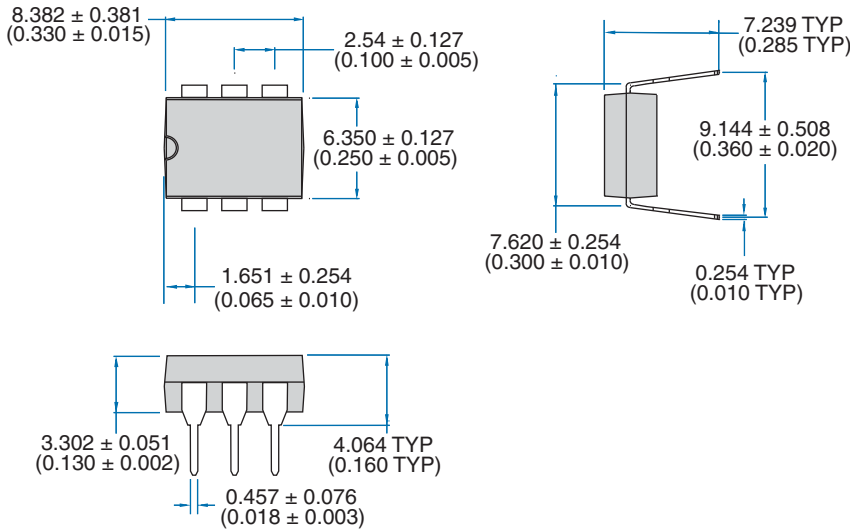

PC Board Pattern

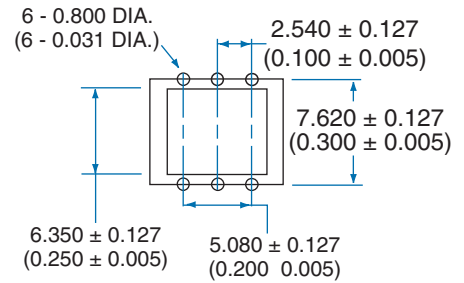

Dimensions
mm
(inches)

6-Pin Surface Mount Package ("S" Suffix)

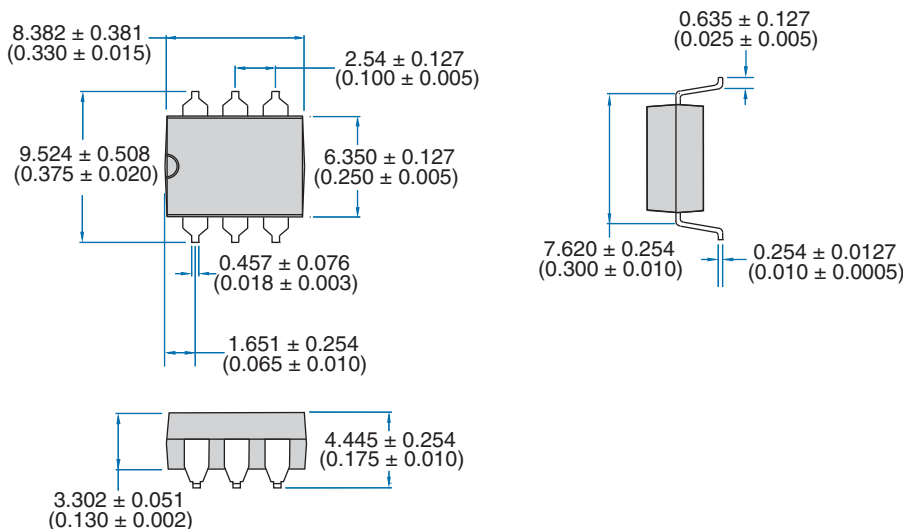

Recommended PCB Land Pattern

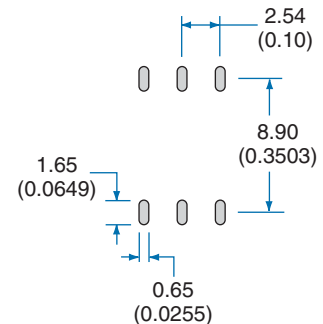

Dimensions
mm
(inches)

MECHANICAL DIMENSIONS (Cont.)

Tape and Reel Packaging for 6-Pin “S” Suffix Parts

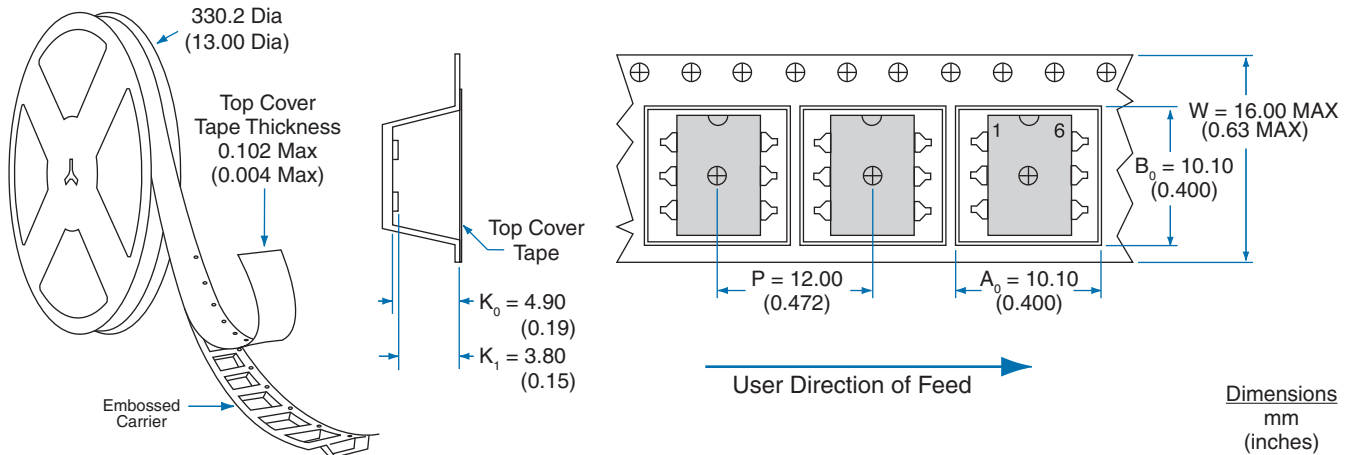

NOTE: Tape dimensions not shown comply with JEDEC Standard EIA-481-2

For additional information please visit our website at: www.clare.com

Clare, Inc. makes no representations or warranties with respect to the accuracy or completeness of the contents of this publication and reserves the right to make changes to specifications and product descriptions at any time without notice. Neither circuit patent licenses nor indemnity are expressed or implied. Except as set forth in Clare's Standard Terms and Conditions of Sale, Clare, Inc. assumes no liability whatsoever, and disclaims any express or implied warranty, relating to its products including, but not limited to, the implied warranty of merchantability, fitness for a particular purpose, or infringement of any intellectual property right.

The products described in this document are not designed, intended, authorized or warranted for use as components in systems intended for surgical implant into the body, or in other applications intended to support or sustain life, or where malfunction of Clare's product may result in direct physical harm, injury, or death to a person or severe property or environmental damage. Clare, Inc. reserves the right to discontinue or make changes to its products at any time without notice.