

FEATURES/BENEFITS

- Zero-cross models for resistive loads
- Low zero-cross turn-on voltage
- Input protection and control LED standard
- IP20 touch-proof flaps optional
- Connectors for power wiring and heat sinks available
- Designed in conformity with EN60947-4-3 (IEC947-4-3) and EN60950/VDE0805 (Reinforced Insulation)



With IP20 touch-proof flaps

Without IP20 touch-proof flaps

Part No.	Load Voltage	Load Current	Control Voltage	Switch Type
STH24D12	12-280 Vac	12A	3-32 Vdc	Zero Cross
STH24D25	12-280 Vac	25A	3-32 Vdc	Zero Cross
STH24D35	12-280 Vac	35A	3-32 Vdc	Zero Cross
STH24D50	12-280 Vac	50A	3-32 Vdc	Zero Cross
STH48D35	24-600 Vac	35A	3-32 Vdc	Zero Cross
STH48D50	24-600 Vac	50A	3-32 Vdc	Zero Cross
STH24D75	24-600 Vac	75A	3-32 Vdc	Zero Cross

MECHANICAL SPECIFICATION

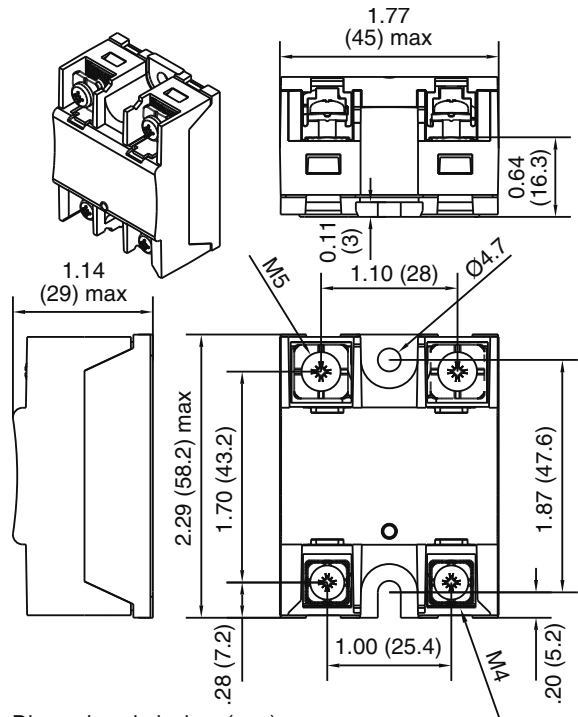

Figure 2

TYPICAL APPLICATION

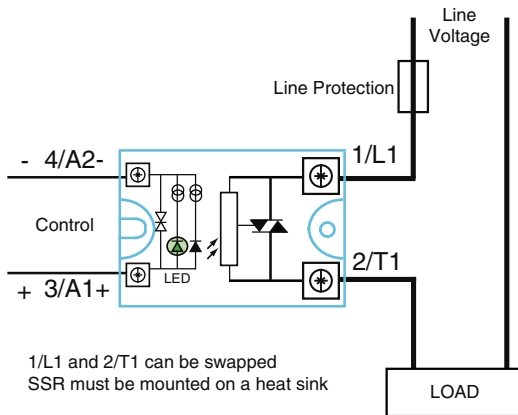

Figure 1a — STH relays, up to 25A

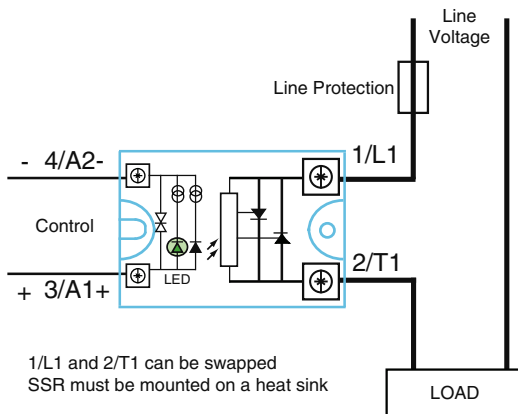

Figure 1b — STH relays, 35A and above

CONTROL CHARACTERISTICS

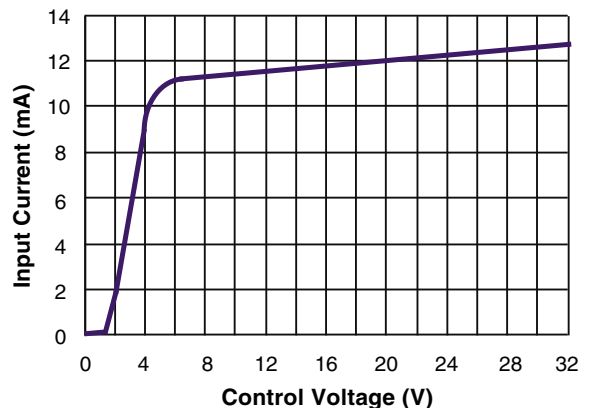

Figure 3 — STH relays

ELECTRICAL SPECIFICATIONS

(+25°C ambient temperature unless otherwise specified)

INPUT (CONTROL) SPECIFICATIONS

	Min	Max	Units
Input Current Range	10	13	mA
Must Turn-Off Voltage	2.0	Vdc	
Reverse Voltage Protection (R/D)		32	V
Clamping Voltage (R/D)		36	V
Input Immunity (EN61000-4-4)		2	kV
Input Immunity (EN61000-4-5)		2	kV

OUTPUT (LOAD) SPECIFICATIONS

	Min	Max	Units
Peak Voltage			
STH24DXX		600	Vpeak
STH48DXX		1200	Vpeak

Load Current Range (Resistive)

	Min	Max	Units
12 output current	.005	12	Arms
25 output current	.005	25	Arms
35 output current	.005	40	Arms
50 output current	.005	60	Arms
75 output current	.005	90	Arms

Maximum Surge Current Rating (Non-Repetitive)

12 output current		170	A
25 output current		350	A
35 output current		500	A
50 output current		720	A
75 output current		1200	A

On-State Voltage Drop

Up to 25 output current		0.85	V
Above 35 output current		0.9	V

Output Power Dissipation (Max)

12 output current	$0.9 \times 0.85 \times I + 0.042 \times I^2$	W
25 output current	$0.9 \times 0.85 \times I + 0.016 \times I^2$	W
35 output current	$0.9 \times 0.9 \times I + 0.015 \times I^2$	W
50 output current	$0.9 \times 0.9 \times I + 0.012 \times I^2$	W
75 output current	$0.9 \times 0.9 \times I + 0.0045 \times I^2$	W

Zero-Cross Window (Typical)	±35	Vac
Off-State Leakage Current	1	mA
Turn-On Time (60 Hz)	8.3	ms
Turn-Off Time (60 Hz)	8.3	ms
Off-State dv/dt	500	V/μs
Maximum di/dt (Non-Repetitive)	50	A/μs
Operating Frequency	0.1	800 Hz

I²t for fuse matching (<10ms)

12 output current	128	A ² s
25 output current	600	A ² s
35 output current	1250	A ² s
50 output current	2500	A ² s
75 output current	7200	A ² s

Junction-Case Thermal Resistance

12 output current	2.5	°C/W
25 output current	1.7	°C/W
35 output current	0.6	°C/W
50 output current	0.45	°C/W
75 output current	0.4	°C/W

Conducted Immunity Level

IEC/EN61000-4-4 (bursts)	2kV criterion B
IEC/EN61000-4-5 (surge)	2kV criterion A (with external VDR)

GENERAL SPECIFICATIONS

(+25°C ambient temperature unless otherwise specified)

ENVIRONMENTAL SPECIFICATIONS

	Min	Max	Units
Operating Temperature			
Up to 35 output current	-55	+80	°C
STH24D50	-40	+100	°C
STH48XXX	-40	+80	°C
Storage Temperature			
Up to 35 output current	-55	+125	°C
STH24D50	-40	+100	°C
STH48XXX	-40	+125	°C
Ambient Humidity	40 to 85		%
Input-Output Isolation	4000		Vrms
Output-Case Isolation			
Up to 25 output current	2500		Vrms
Above 35 output current	4000		Vrms
Insulation Resistance @500Vdc	1000		MΩ
Rated Impulse Voltage	4000		V
Protection Level (CEI529)	IP20		
Vibration (10–55 Hz according to CE168)	1.5		mm
Shock (according to CD168)	30/50		g
Housing Material	PA6 UL94VO		
Baseplate	Aluminum, nickel-plated		

SURGE CURRENT

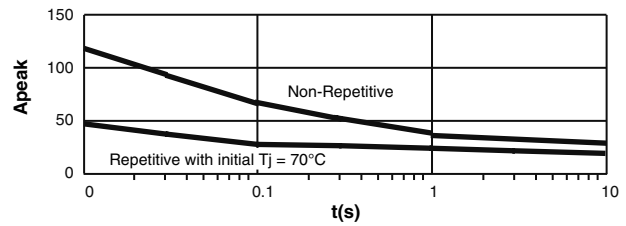

Figure 4a — 12A output current

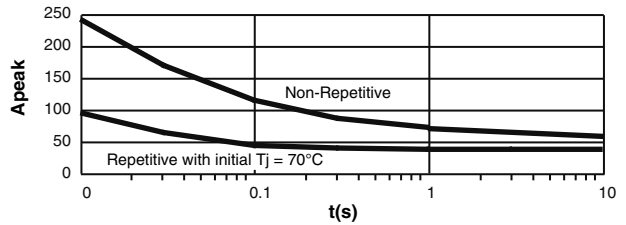

Figure 4b — 25A output current

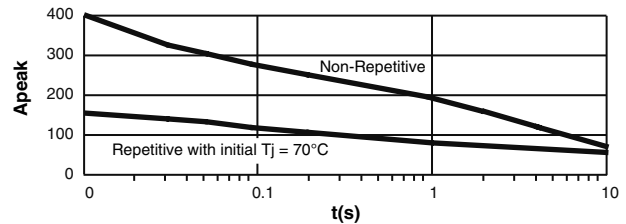

Figure 4c — 35A output current

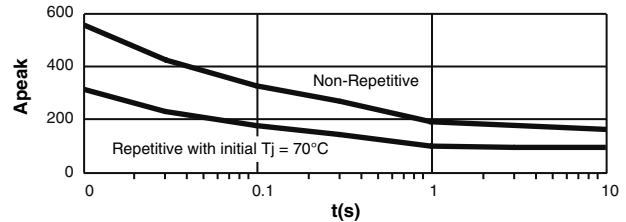

Figure 4d — 50A output current

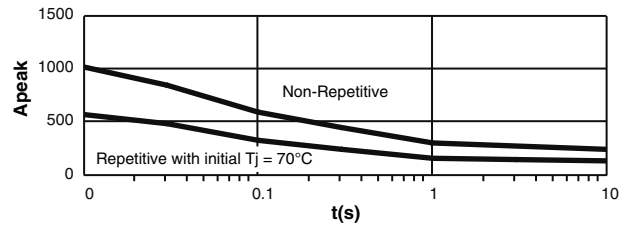

Figure 4e — 75A output current

THERMAL CURVES

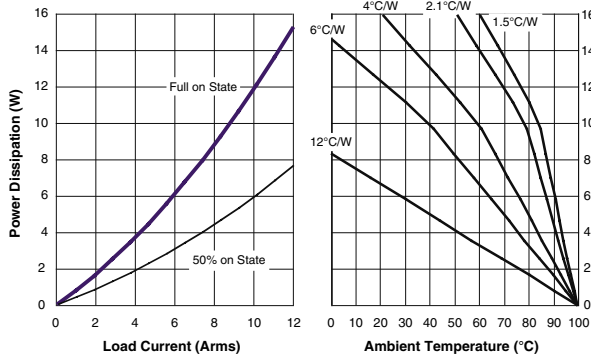

Figure 5a — 12A output power

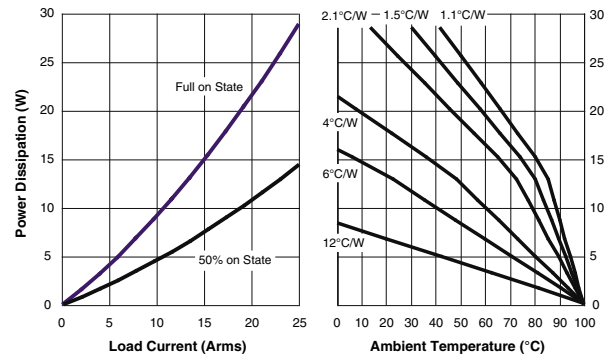

Figure 5b — 25A output power

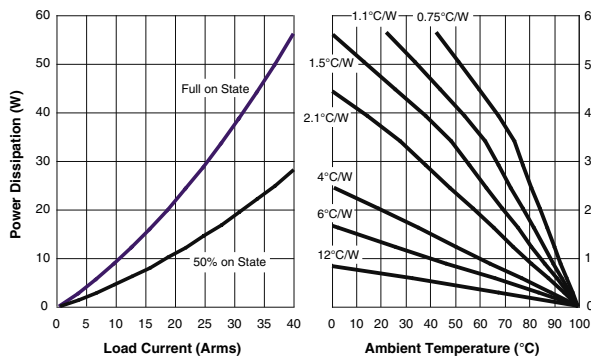

Figure 5c — 35A output power

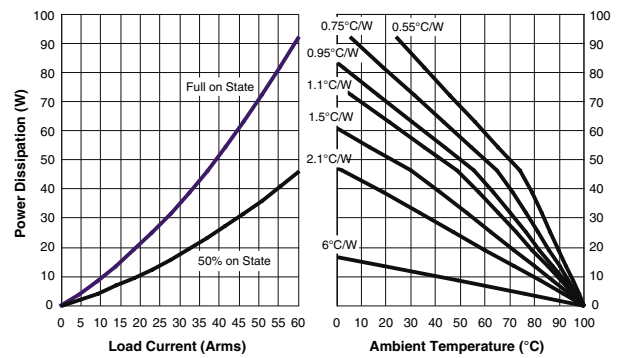

Figure 5d — 50A output power

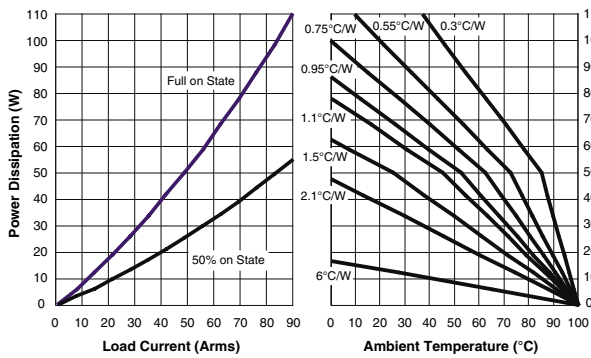

Figure 5e — 75A output power

12°C/W corresponds to a relay without heat sink
6°C/W corresponds to a relay mounted on a DIN-rail adaptor (Teledyne P/N DL12)

OPTIONAL CONNECTIONS



Directly with wires,
with or without ferrules



With tips
(ring terminals)

CONTROL WIRING

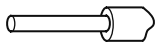
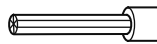
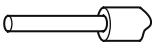
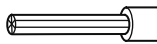
Number of Wires				Screwdriver Type	Recommended Torque
1		2			
Solid (no ferrule)	Fine Stranded (with ferrule)	Solid (no ferrule)	Fine Stranded (with ferrule)		N.m
					
AWG18...AWG14	AWG18...AWG14	AWG18...AWG14	AWG18...AWG14		

POWER WIRING

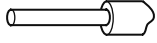
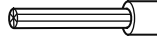
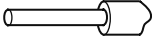
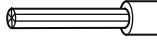
Number of Wires				Screwdriver Type	Recommended Torque
1		2			
Solid (no ferrule)	Fine Stranded (with ferrule)	Solid (no ferrule)	Fine Stranded (with ferrule)		N.m
					
AWG16...AWG8	AWG16...AWG10	AWG16...AWG8	AWG16...AWG10		

Power with tips

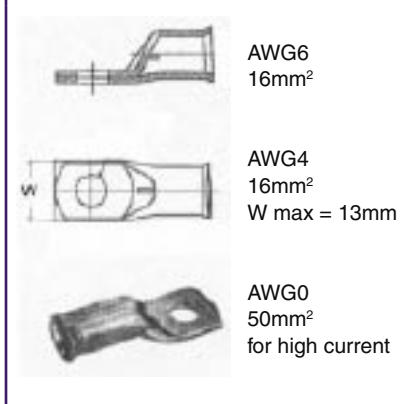

Options

TF100
Flap reference without mounting

P/N + -16
1 flap (on output) + 1 Teledyne mounting

P/N + -17
2 flaps (input & output) + 2 Teledyne mounting

Fastons: Call us

- Connectors for power wiring and heat sinks available
- Designed in conformity with EN60947-4-3 (IEC947-4-3) and EN60950/VDE0805 (Reinforced Insulation)





2–2.5°C/W
Teledyne P/N FW151



1.1°C/W
Teledyne P/N FW108



0.3°C/W
Teledyne P/N FW031

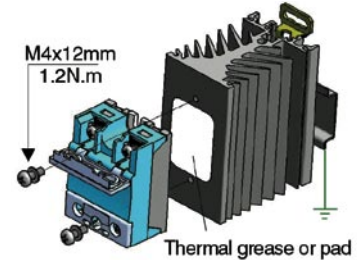

Thermal grease or pad



DIN Rail Adapter
Teledyne P/N DL12

Mounting

HIPpak SSRs must be mounted on heat sinks. A large range of heat sinks is available. For heat-sink mounting, use thermal grease or a thermal pad with high conductivity specified by Teledyne.



Thermal Pad
Teledyne P/N –12

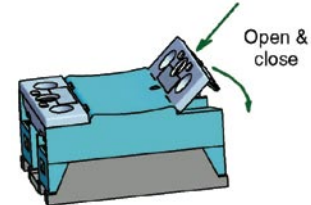

Removable IP20 touch-proof flaps

Typical Loads

STH relays are designed for AC-51 resistive loads (heating). For other loads, consult our selection guide.

Protection

- To protect the SSR against a short-circuit of the load, use a fuse with a I^2t value = 1/2 I^2t value specified.

EMC

Immunity:

- Our data sheets list the immunity level of our SSRs according to the main standards for these of products: IEC/EN61000-4-4 and IEC/EN61000-4-5. You can compare the high immunity level with other products on the market.

Emission:

- Teledyne SSRs are designed in compliance with standards for class A equipment (Industry).
- Use of this product in domestic environments may cause radio interference. In this case the user may be required to employ additional devices to reduce noise. SSRs are complex devices that must be interconnected with other equipment (loads, cables, etc.) to form a system. Because the other equipment or interconnections may not be under Teledyne's control, it shall be the responsibility of the system integrator to ensure that systems containing SSRs comply with the requirement of any rules and regulations applicable at the system level.