

MOS FET Relays

G3VM-355C/CR/F/FR

MOS FET Relay with Both SPST-NO and SPST-NC Contacts Incorporated in a Single DIP Package. General-purpose Models Added.

- SPST-NO/SPST-NC models included in the 350-V load series.
- Continuous load current of 120 mA.
- Dielectric strength of 2,500 Vrms between I/O.
- General-purpose models (high ON resistance) added.
- RoHS Compliant.

Application Examples

- Measurement devices
- Security systems
- Amusement machines

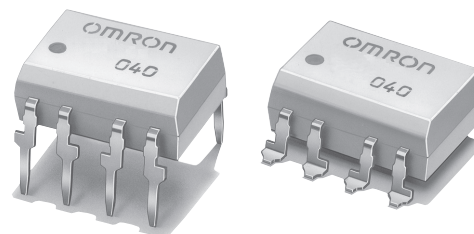

Note: The actual product is marked differently from the image shown here.

List of Models

Contact form	Terminals	Load voltage (peak value)	Model	Number per stick	Number per tape
SPST-NO/ SPST-NC	PCB terminals	350 VAC	G3VM-355CR	50	---
			G3VM-355C		
			G3VM-355FR		
			G3VM-355F		
	Surface-mounting terminals		G3VM-355FR(TR)	---	1,500
			G3VM-355F(TR)		

Dimensions

Note: All units are in millimeters unless otherwise indicated.

G3VM-355C/CR

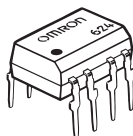

Note: The actual product is marked differently from the image shown here.

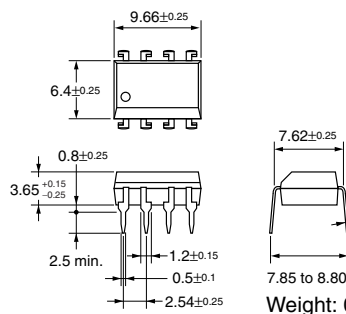

G3VM-355F/FR

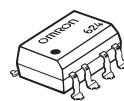

Note: The actual product is marked differently from the image shown here.

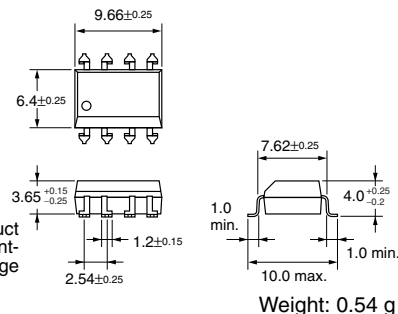

Terminal Arrangement/Internal Connections (Top View)

G3VM-355C/CR

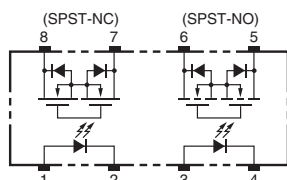

G3VM-355F/FR

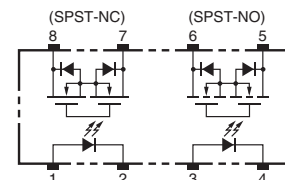

PCB Dimensions (Bottom View)

G3VM-355C/CR

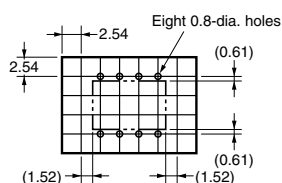

Actual Mounting Pad Dimensions (Recommended Value, Top View)

G3VM-355F/FR

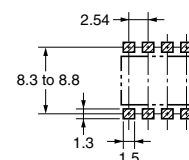

■ Absolute Maximum Ratings (Ta = 25°C)

Item		Symbol	Rating	Unit	Measurement conditions
Input	LED forward current	I_F	50	mA	
	Repetitive peak LED forward current	I_{FP}	1	A	100 μ s pulses, 100 pps
	LED forward current reduction rate	$\Delta I_F/^\circ\text{C}$	-0.5	mA/°C	Ta \geq 25°C
	LED reverse voltage	V_R	5	V	
	Connection temperature	T_j	125	°C	
Output	Load voltage (AC peak/DC)	V_{OFF}	350	V	
	Continuous load current (AC peak/DC)	I_O	120 (100)	mA	
	ON current reduction rate	$\Delta I_{ON}/^\circ\text{C}$	-1.2 (-1)	mA/°C	Ta \geq 25°C
	Connection temperature	T_j	125	°C	
Dielectric strength between input and output (See note 1.)		V_{I-O}	2,500	V_{rms}	AC for 1 min
Operating temperature		T_a	-40 to +85	°C	With no icing or condensation
Storage temperature		T_{stg}	-55 to +125	°C	With no icing or condensation
Soldering temperature (10 s)		---	260	°C	10 s

Note: 1. The dielectric strength between the input and output was checked by applying voltage between all pins as a group on the LED side and all pins as a group on the light-receiving side.

Values in parentheses are for the G3VM-355C/F

■ Electrical Characteristics (Ta = 25°C)

Item		Sym	Mini-	Typical	Maxi-	Unit	Measurement conditions
Input	LED forward voltage	V_F	1.0	1.15	1.3	V	$I_F = 10$ mA
	Reverse current	I_R	---	---	10	μ A	$V_R = 5$ V
	Capacity between terminals	C_T	---	30	---	pF	$V = 0$, $f = 1$ MHz
	Trigger LED forward current	I_{FT}	---	1	3	mA	SPST-NO: $I_O = 120$ mA (100 mA) SPST-NC: $I_{OFF} = 10$ μ A
Output	Maximum resistance with output ON	R_{ON}	---	15 (40)	25 (50)	Ω	SPST-NO: $I_F = 5$ mA, $I_O = 120$ mA (100 mA) SPST-NC: $I_F = 0$ mA, $I_O = 120$ mA (100 mA)
				0.0015 NO (0.006)	1.0	μ A	$V_{OFF} = 350$ V
	Current leakage when the relay is open	I_{LEAK}	---	0.0105 NC (0.003)	---	---	---
Capacity between terminals		C_{OFF}	---	65 (30)	---	pF	$V = 0$, $f = 1$ MHz (NO) $V = 0$, $f = 1$ MHz, $I_F = 5$ mA (NC)
Capacity between I/O terminals		C_{I-O}	---	0.8	---	pF	$f = 1$ MHz, $V_s = 0$ V
Insulation resistance		R_{I-O}	1,000	---	---	M Ω	$V_{I-O} = 500$ VDC, $R_{oh} \leq 60\%$
Turn-ON time	SPST-NO	t_{ON}	---	0.18 (0.3)	1.0 (1.0)	ms	$I_F = 5$ mA, $R_L = 200$ Ω , $V_{DD} = 20$ V (See note 2.)
	SPST-NC	t_{ON}	---	0.15 (0.25)	1.0 (1.0)	ms	
Turn-OFF time	SPST-NO	t_{OFF}	---	0.11 (0.15)	1.0 (1.0)	ms	
	SPST-NC	t_{OFF}	---	0.7 (0.5)	3.0 (1.0)	ms	

Values in parentheses are for the G3VM-355C/F

■ Recommended Operating Conditions

Use the G3VM under the following conditions so that the Relay will operate properly.

Item	Symbol	Minimum	Typical	Maximum	Unit
Load voltage (AC peak/DC)	V_{DD}	---	---	280	V
Operating LED forward current	I_F	5	---	25	mA
Continuous load current (AC peak/DC)	I_O	---	---	120 (100)	mA
Operating temperature	T_a	-20	---	65	°C

Values in parentheses are for the G3VM-355C/F

Note: 2. Turn-ON and Turn-OFF Times

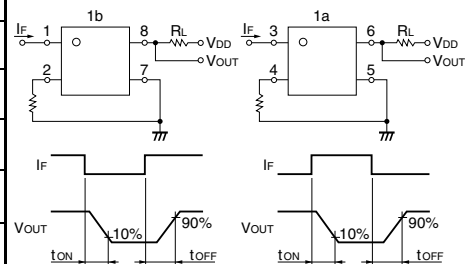

■ Engineering Data

G3VM-355C/F

Common Characteristics; SPST-NO / SPST-NC

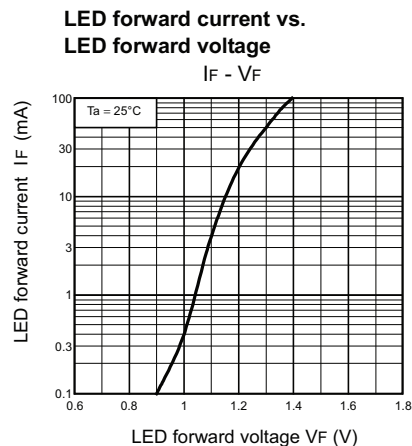
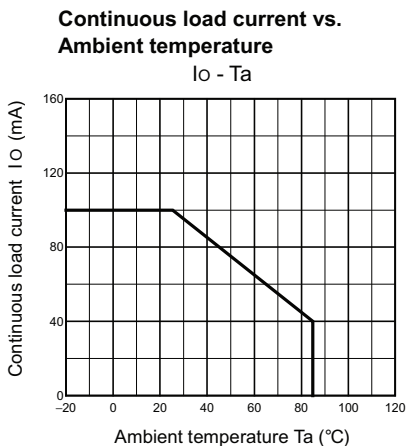
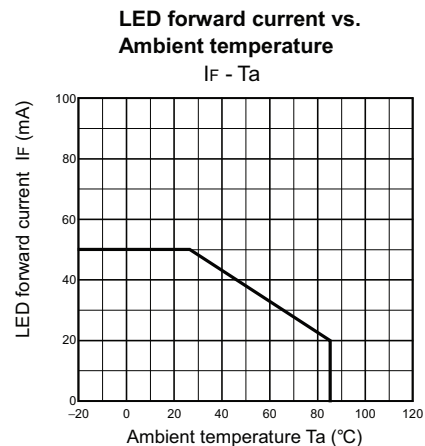

Characteristics; SPST-NO

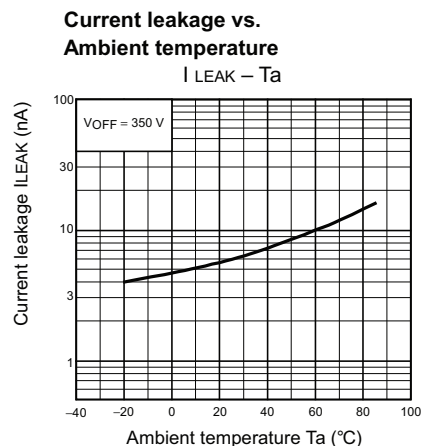
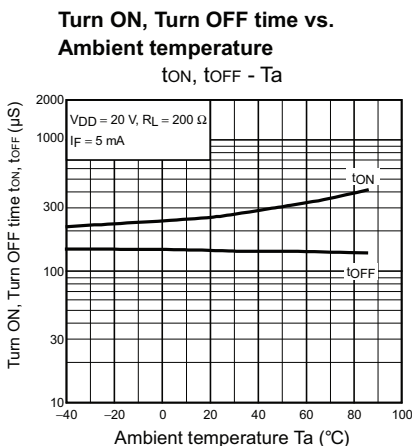
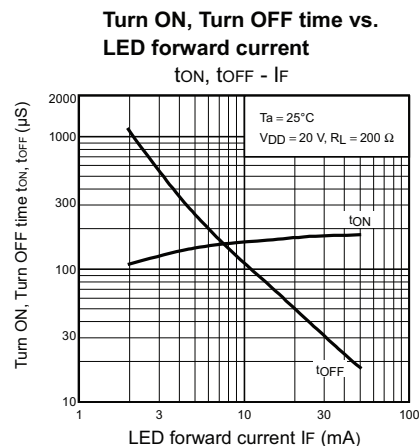
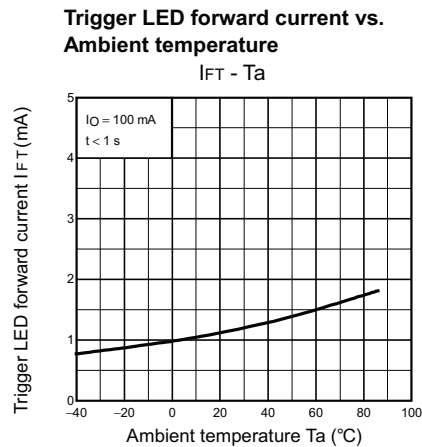
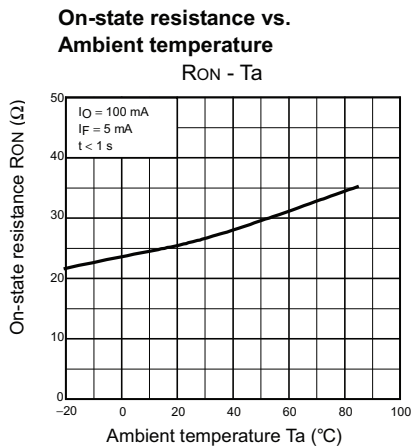
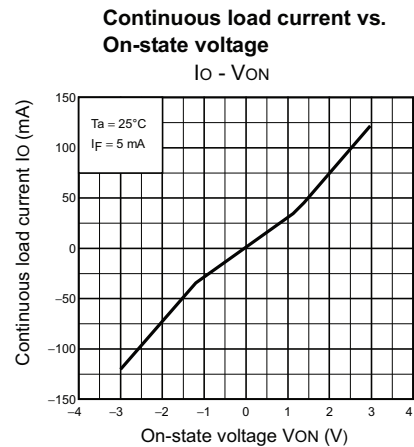

■ Engineering Data
G3VM-355C/F (continued)
 Characteristics; SPST-NC

Continuous load current vs. On-state voltage
 $I_O - V_{ON}$

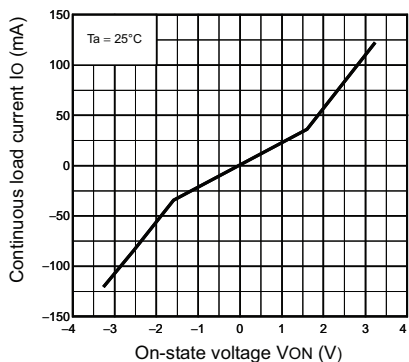

On-state resistance vs. Ambient temperature
 $R_{ON} - T_a$

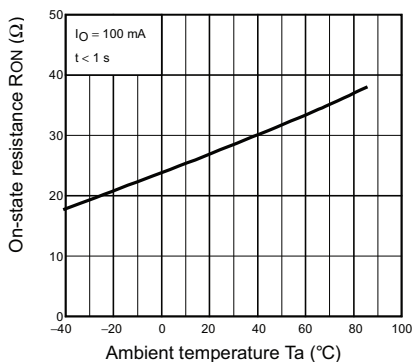

Trigger LED forward current vs. Ambient temperature
 $I_{FC} - T_a$

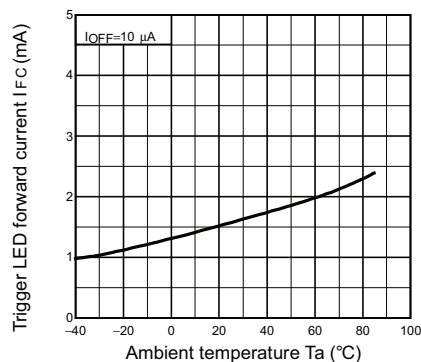

Turn ON, Turn OFF time vs. LED forward current
 $t_{ON}, t_{OFF} - I_F$

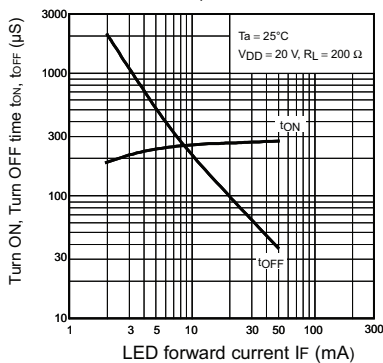

Turn ON, Turn OFF time vs. Ambient temperature
 $t_{ON}, t_{OFF} - T_a$

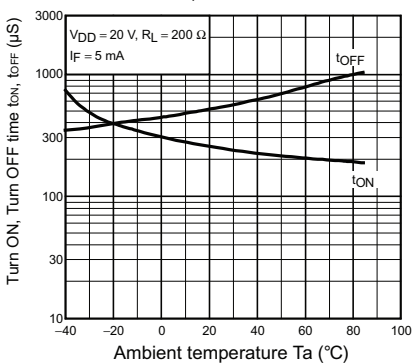

Current leakage vs. Ambient temperature
 $I_{LEAK} - T_a$

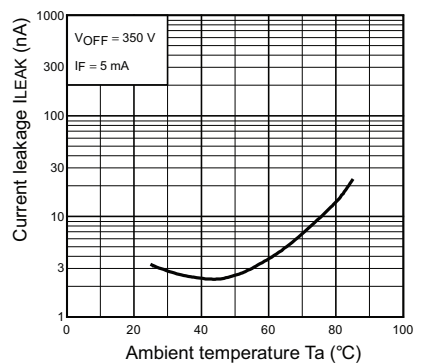

■ Engineering Data

G3VM-355CR/FR

Common Characteristics; SPST-NO / SPST-NC

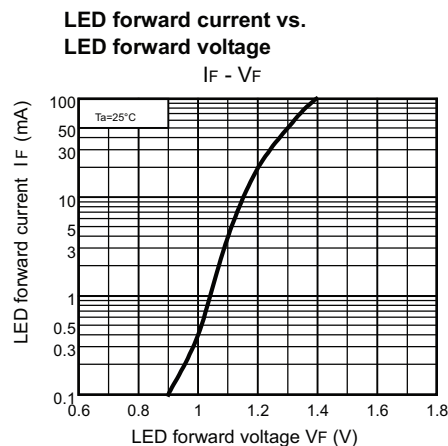
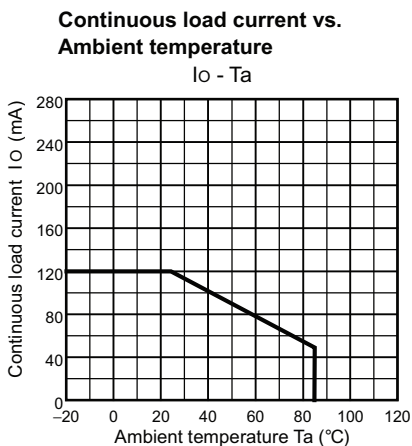
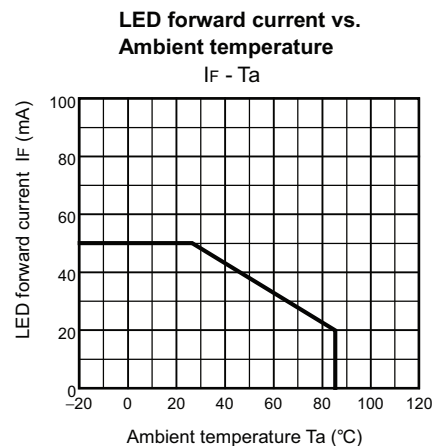

Characteristics; SPST-NO

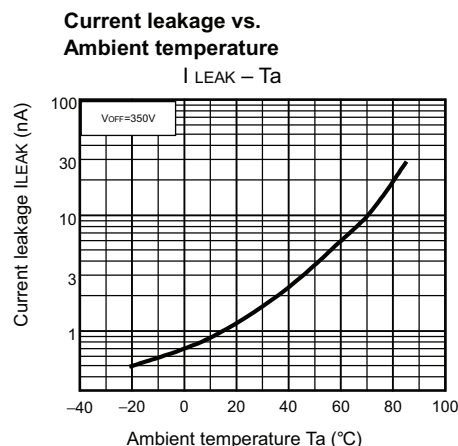
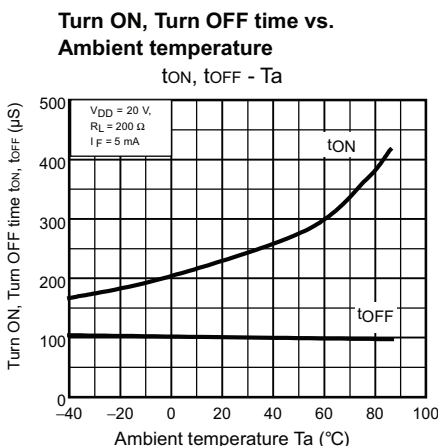
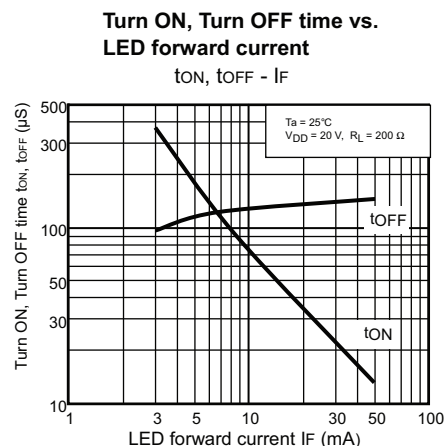
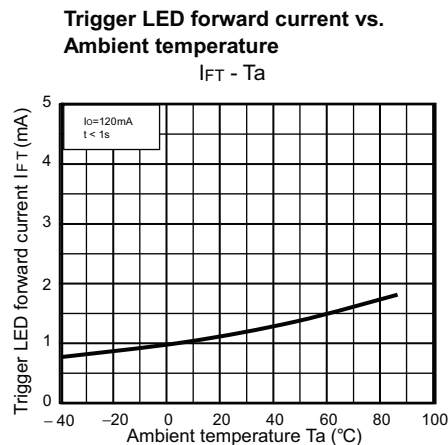
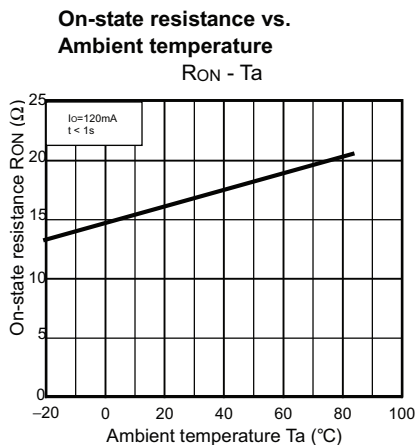
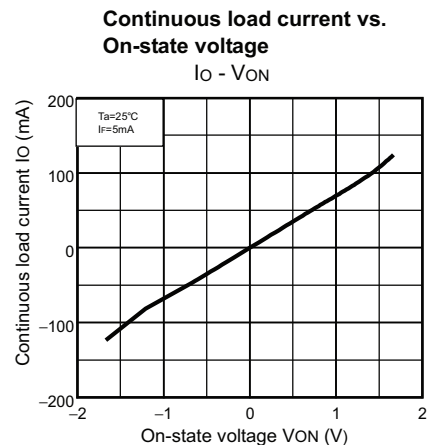

■ Engineering Data
G3VM-355CR/FR (continued)
 Characteristics; SPST-NC

Continuous load current vs. On-state voltage
 $I_O - V_{ON}$

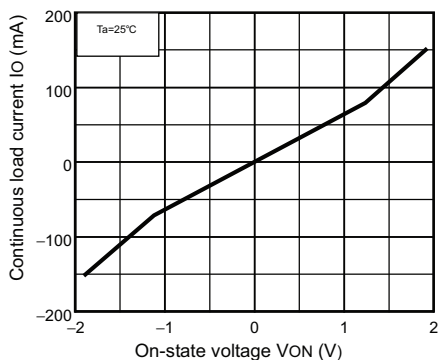

On-state resistance vs. Ambient temperature
 $R_{ON} - T_a$

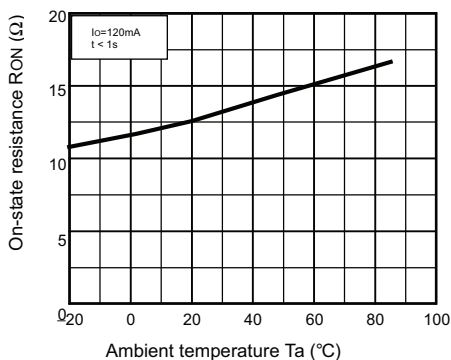

Trigger LED forward current vs. Ambient temperature
 $I_{FC} - T_a$

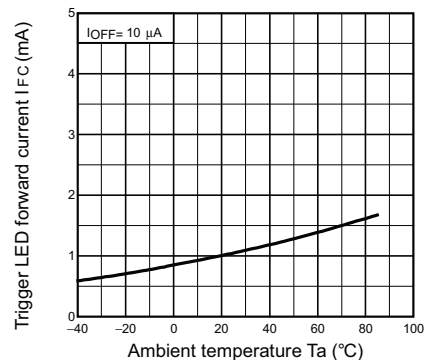

Turn ON, Turn OFF time vs. LED forward current
 $t_{ON}, t_{OFF} - I_F$

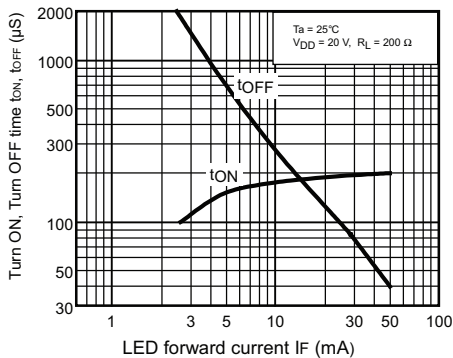

Turn ON, Turn OFF time vs. Ambient temperature
 $t_{ON}, t_{OFF} - T_a$

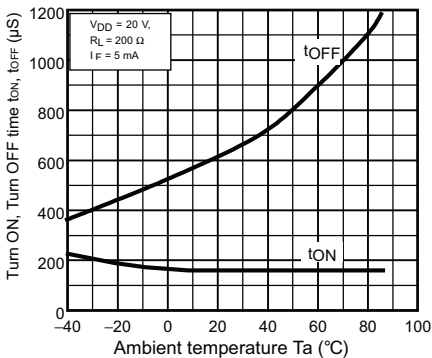

Current leakage vs. Ambient temperature
 $I_{LEAK} - T_a$

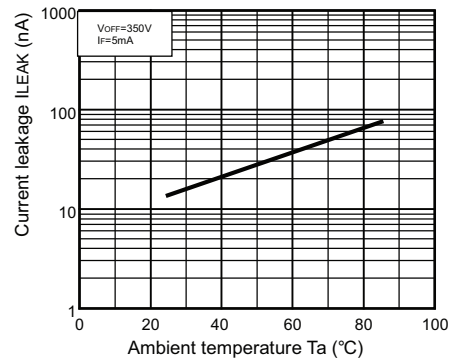

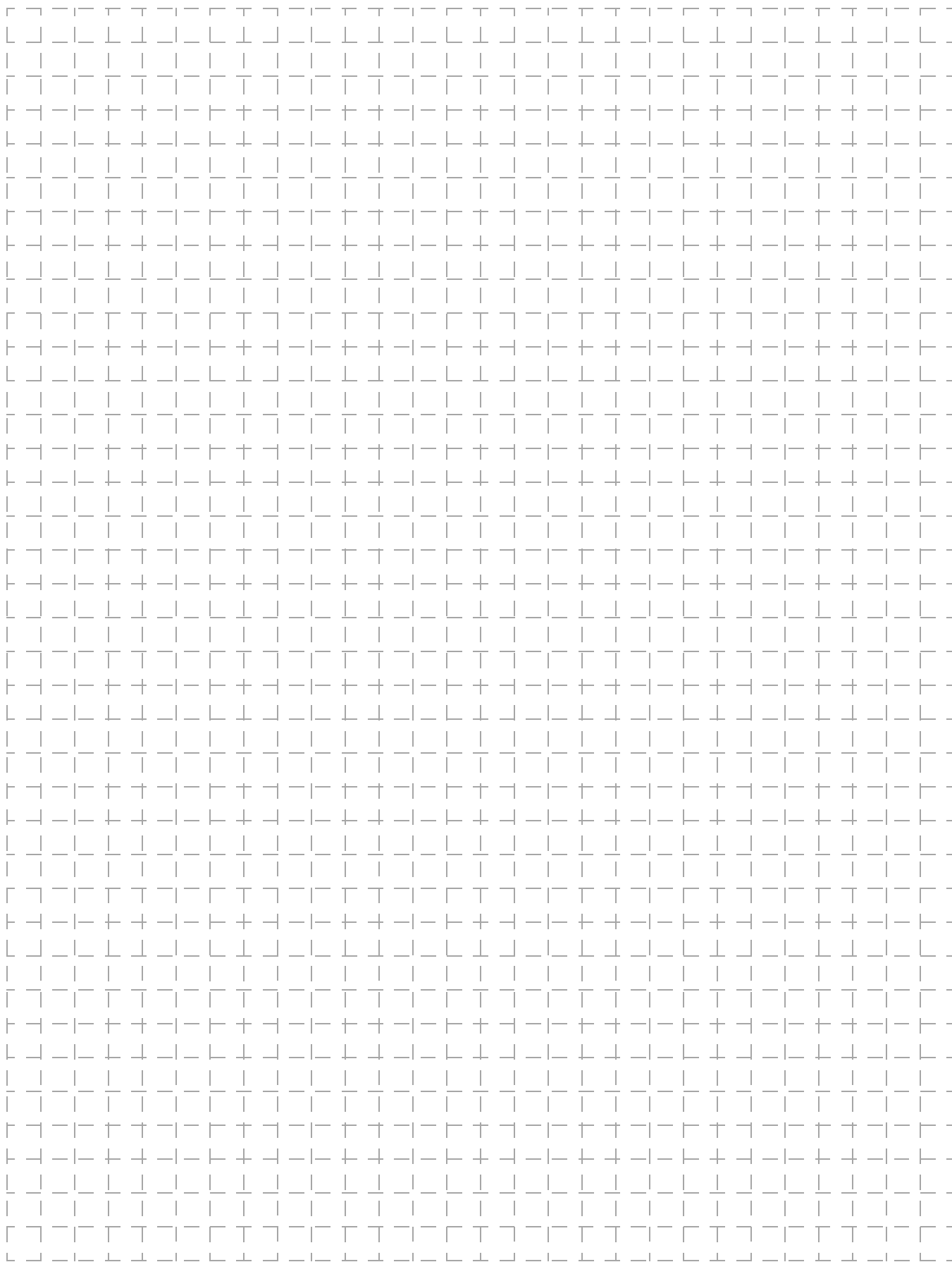

All sales are subject to Omron Electronic Components LLC standard terms and conditions of sale, which can be found at http://www.components.omron.com/components/web/webfiles.nsf/sales_terms.html

ALL DIMENSIONS SHOWN ARE IN MILLIMETERS.
To convert millimeters into inches, multiply by 0.03937. To convert grams into ounces, multiply by 0.03527.

OMRON[®]

**OMRON ELECTRONIC
COMPONENTS LLC**

55 E. Commerce Drive, Suite B
Schaumburg, IL 60173

847-882-2288

OMRON ON-LINE

Global - <http://www.omron.com>

USA - <http://www.components.omron.com>

Cat. No. X302-E-1

12/10

Specifications subject to change without notice

Printed in USA

MOS FET Relays **G3VM-355C/CR/F/FR**