

Digital Fiber Optic & Laser Optic Sensor Guide



E32 Series Fiber Units

Amplifier Units



E3X-DAC-S True Color Series



E3X-DA-S/-MDA Series



E3X-NA/-SD Series

- »Offering unsurpassed sensing solutions
- »General purpose, standard detection requirements
- »Special beam, non-standard requirements
- »Application specific requirements

Automation...simple...powerful.

CONTENTS

■ Fiber Unit Overview

Standard Models	Flexible (New Standard).....	4
	Standard	4
	Break-resistant.....	4
	Fluorine Coated	5
Special-beam Models	Long Distance, High Power.....	8
	Ultracompact, Ultrafine Sleeve.....	8
	Coaxial, Small Spot	9
	Fine Beam (narrow Vision Field).....	10
	Area Sensing.....	10
	Retroreflective	11
	Limited-reflective	11
Environmental-resistive Models	Heat-resistant.....	12
	Chemical-resistant.....	12
	Vacuum-resistant.....	13
Application-specific Models	Label Detection	14
	Liquid-level Detection.....	14
	Glass-substrate Alignment.....	15
	Glass-substrate Mapping.....	15
	Water Mapping.....	16
	True Color Detection	16
Ordering Information	Through-beam Fiber Units.....	18
	Fiber Units with Reflective Sensors.....	29
	Application-specific Fiber Units.....	38
	Through-beam Fiber Units used with E3X-DAC True Color Detection.....	41
	Fiber Units with Reflective Sensors used with E3X-DAC True Color Detection.....	43
	Accessories.....	45
Ratings/Characteristics		49
Dimensions	Through-beam Fiber Units.....	51
	Fiber Units with Reflective Sensors.....	58
	Application-specific Fiber Units.....	65
	Accessories.....	68
Precautions.....		70

■ Amplifier Overview

Ordering Information/Ratings/Characteristics	E3X-SD Simple Fiber Optic Amplifiers with Digital Display	73
	E3X-NA Simple Fiber Optic Amplifiers with Bar Graph Display.....	73
	E3X-DA-S Dual Display Digital Fiber Optic Amplifiers.....	75
	E3X-MDA Two-channel Dual Display Digital Fiber Optic Amplifiers	77
	E3X-DAC-S True Color Fiber Optic Amplifiers with Digital Dual Display	79

■ Laser Optic Unit Overview

Sensing Heads.....	81
E3C-LDA Dual Display Laser Optics Amplifiers	81
Ratings/Characteristics	83
Accessories.....	85
Dimensions.....	85

■ Accessories

Accessories.....	86
------------------	----

■ Dimensions

Dimensions.....	90
-----------------	----

<i>Index</i>	98
--------------------	----

Fiber Unit

Standard Models

Solutions for General-Purpose Applications

These Fibers Units can be used in a variety of applications, such as detecting the presence of workpieces and positioning.

A Wide Variety of Shapes for Adapting to Different Installation Locations

Choose the model that suits the installation space from a wide variety of shapes and sizes (7 shapes, in standard or small sizes).

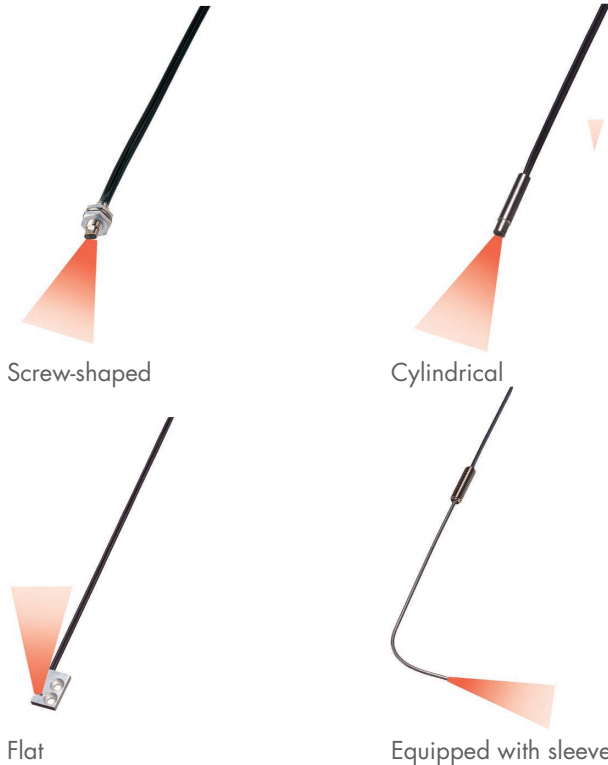

Space Savings and Simple Mounting

Flat Models

Flat models that allow simple screw mounting and straightforward wiring have been added to the lineup. Using these models eliminates the problem of fibers getting caught on surrounding objects.

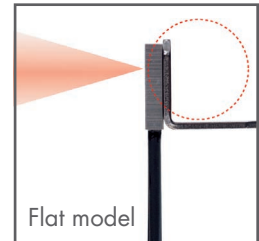

Detect Workpieces in Tight Spaces

Custom-produced Sleeves

Models with sleeves allow detection in tight spaces. We will perform the time-consuming task of fashioning the sleeve, with a length and bends to suit the space (except for ultrafine sleeves).



Flexible, Pliable Fiber That Can Be Handled Like Wire

We have developed a broad range of fibers to meet a wide variety of needs. Multicore (flexible) fiber is a new type of standard fiber that can be used like wire without worrying about the bending radius. We have also produced fiber that will not break when used in moving parts and fiber that is not degraded by contact with oil.

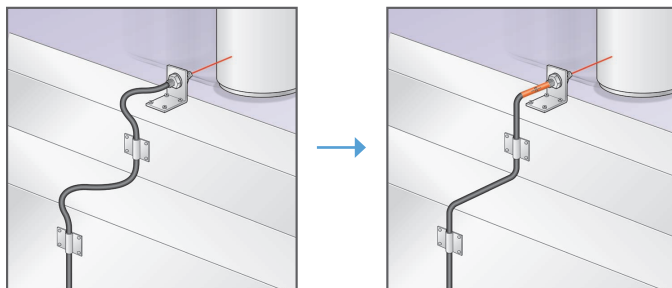

Conventional fiber

Flexible fiber

You will certainly appreciate the ease of use that flexible fiber ensures.

Cut to Length in the Field

Omron's fibers marked with this symbol  let you customize the length and eliminate excess fiber for a tidy, safe installation.

Length Can Be Specified in 1-m Units

Saving Energy and Work

We will produce fiber of the required length (in meter units). For large-scale installations, specifications of up to 20 m can be handled. (Specifications of 0.3 m and 0.5 m are also possible.)



Special-beam Models

Detection with Increased Reliability

A variety of heads incorporating the latest optical technology makes it possible to solve common problems related to detection and to increase reliability.

- Resistant to dust and dirt
- Capable of detecting small workpieces
- Resistant to workpiece vibration

Use these models to handle unstable detection conditions.



Small-spot models
E32-C42+
E39-F3A



Area-sensing models
E32-T16J



Limited-reflective models
E32-L24L



Area-sensing models
E32-T16J

Environment-resistive Models

High Resistance to External Conditions with Fiber

We have developed model variations for adapting to a variety of environmental conditions. These models enable detection in high-temperature environments and vacuums.

- High-temperature environments
- Environments subject to the splattering of chemicals
- Vacuums

Use these models to handle applications in special environments.



Heat-resistant models



Chemical-resistant models

Application-specific Models

Fiber Units for the Food-packaging, Semiconductor, and Solar Industries

These models, which were developed for specific applications, offer top-quality detection performance.

- Label detection
- Liquid-level detection
- Alignment and mapping of glass substrates
- Wafer mapping
- True color detection
- Distance measurement

Use these models for specific applications.



Label-detection models
E32-G14



Alignment-check models
E32-L16



Liquid-level detection models
E32-D36T

Standard Models

Flexible (New Standard)

R : Flexible fiber

- Perform wiring without worrying about the bending radius.
- Choose the model to suit the installation space from a variety of shapes.

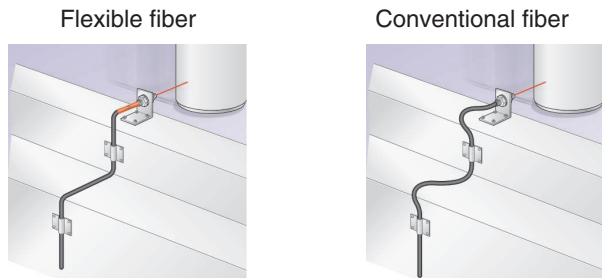

Fewer problems ◀ Light intensity affected by bends in fiber
Fiber broken by getting caught on surrounding objects

■ Feature: Multicore (Flexible) Fibers



A large number of ultrafine cores are all surrounded by cladding. As a result, the fiber is flexible and can be bent without significantly reducing the light intensity. This helps solve problems, such as fiber being broken by getting caught on other objects.

■ Ratings/Characteristics

Min. sensing object	0.005-mm dia.
Min. bending radius	1 mm
Ambient temperature	-40°C to 70°C (no icing or condensation)
Fiber material	Plastic Free-cut

Standard

- Choose the model to suit the installation space from a variety of shapes.
- New flat models allow space savings and simple installation.

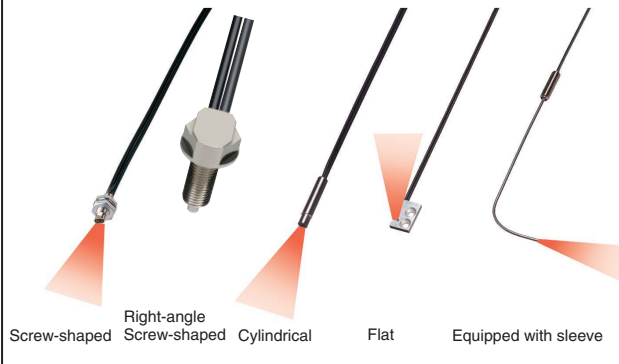

■ Feature: Flat Models

Flat models, which allow simple attachment and wiring, have been added to the lineup. Choose the model to suit the installation space from 3 sensing directions and 2 sizes, standard and small.



■ Ratings/Characteristics

Min. sensing object	0.005-mm dia.
Min. bending radius	10 or 25 mm*
Ambient temperature	-40°C to 70°C (no icing or condensation)
Fiber material	Plastic Free-cut

* Depends on the fiber diameter.

Break-resistant

B : Bendable fiber

- Bundle-fiber models can be used for moving parts.
- Capable of withstanding at least one million repeated bends (in typical applications).

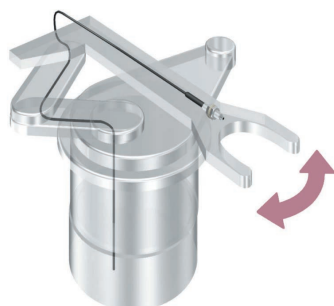

■ Feature: Bundle Fibers

The Fiber Units contain a large number of independent fine fibers, ensuring a high degree of flexibility.

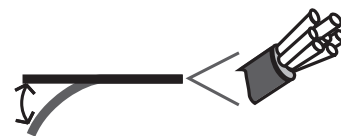

■ Ratings/Characteristics

Min. sensing object	0.005-mm dia.
Min. bending radius	4 mm (withstands repeated bending)
Ambient temperature	-40°C to 70°C (no icing or condensation)
Fiber material	Plastic Free-cut

Standard Models

Fluorine Coating

U: Fluorine-coated fiber

- Fiber degradation due to oil is prevented using a fluororesin coating.
- Free cutting is possible with cutter provided.

Oil is blocked!

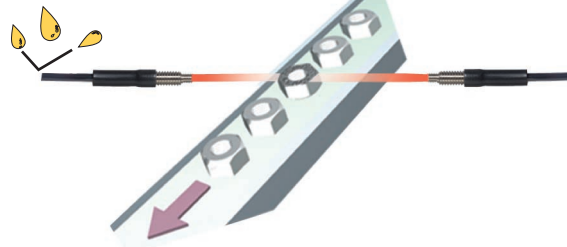

Feature: Fluorine Coating

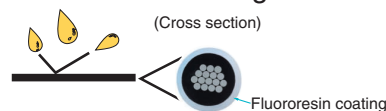

Fluororesin is used as the sheath material to prevent fiber degradation resulting from oil adhesion.

Note: The tip of the head is not chemical-resistant.

Ratings/Characteristics

Min. sensing object	0.005-mm dia.
Min. bending radius	4 mm
Ambient temperature	-40°C to 70°C (no icing or condensation)
Fiber material	Plastic Free-cut

Fiber Customization Service

(Fiber Length, Sleeve Length, and Bends)

Fiber Length

- Applicable Models
Standard models
- Model Number Used for Ordering
Standard model number + Fiber length
Fiber length: 0.3 m, 0.5 m, or any length from 1 to 20 m (in 1-m units)



Sleeve Length and Bends

This customization/delivery service applies to standard models. It is aimed at reducing industrial waste and simplifying the installation procedure.

Model Number Used When Changing the Sleeve Length and Bends

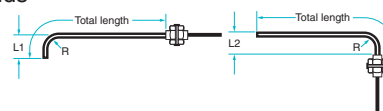

Model Numbers Incorporating the Bending Radius, R, and Dimensions L1 and L2

Fiber Length vs. Sensing Distance

Through-beam Fiber Units
E32-TC200B/E32-TC200F
(Fiber length of 2 m corresponds to 100%.)

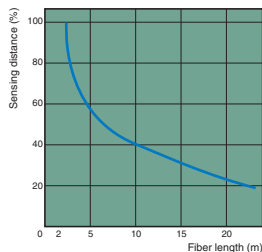

Fiber Units with Reflective Sensors
E32-DC200B/E32-DC200F
(Fiber length of 2 m corresponds to 100%.)

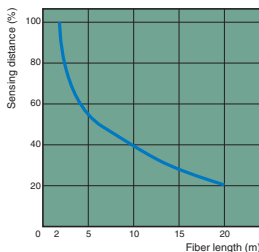

Model Number Used When Changing Only the Sleeve Length

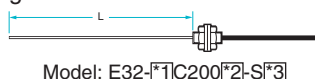

*1: Insert "T" for Through-beam Fiber Units and "D" for Fiber Units with Reflective Sensors.
*2: Insert the "B" or "F" that appears at the end of the original model number.
*3: Insert "50" if the total length is 50 mm. The total length must not exceed 120 mm.

Specifying L1 Only

Bending Radius	L1 (±1)	Model number
R5	10	E32- ^{*1} C200 ^{*2} -S ^{*3} A1
	15	E32- ^{*1} C200 ^{*2} -S ^{*3} A2
R7.5	12.5	E32- ^{*1} C200 ^{*2} -S ^{*3} B1
	17.5	E32- ^{*1} C200 ^{*2} -S ^{*3} B2
R10	15	E32- ^{*1} C200 ^{*2} -S ^{*3} C1
	20	E32- ^{*1} C200 ^{*2} -S ^{*3} C2
R12.5	17.5	E32- ^{*1} C200 ^{*2} -S ^{*3} D1
	22.5	E32- ^{*1} C200 ^{*2} -S ^{*3} D2

Specifying L2 Only













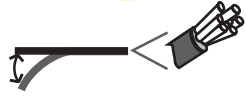
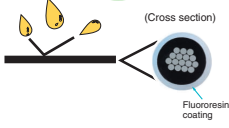
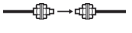







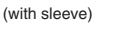



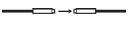











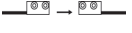



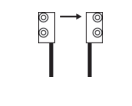

Bending Radius	L2 (±1)	Model number
R5	5	E32- ^{*1} C200 ^{*2} -S ^{*3} A3
	10	E32- ^{*1} C200 ^{*2} -S ^{*3} A4
R7.5	7.5	E32- ^{*1} C200 ^{*2} -S ^{*3} B3
	17.5	E32- ^{*1} C200 ^{*2} -S ^{*3} B4
R10	10	E32- ^{*1} C200 ^{*2} -S ^{*3} C3
	20	E32- ^{*1} C200 ^{*2} -S ^{*3} C4
R12.5	12.5	E32- ^{*1} C200 ^{*2} -S ^{*3} D3
	22.5	E32- ^{*1} C200 ^{*2} -S ^{*3} D4

Standard Models

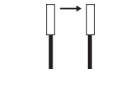
Sensing distance (mm)
(See note 1.)

Overview of Model Variations

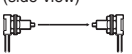
Through-beam Fiber Units

Type (See note 2.)		Flexible (New Standard) <i>R</i>  Flexible and pliable	Standard 	Break-resistant <i>B</i>  Withstands repeated bending	Fluorine coating <i>U</i>  Cable protected against oil
Shape of head					
Screw-shaped (top-view) 	M4	 530	 760	 680	 680
	E32-T11R		E32-TC200	E32-T11	E32-T11U
	M3	 130	 220	 200	
	E32-T21R		E32-TC200E	E32-T21	
(with sleeve) 	M4 (1.2-dia. sleeve)	 530	 760		
	E32-TC200BR		E32-TC200B		
	M3 (0.9-dia. sleeve)	 130	 220		
	E32-TC200FR		E32-TC200F		
Cylindrical (top-view) 	3 dia.	 530	 760	 680	
	E32-T12R		E32-T12	E32-T12B	
	1.5 dia.	 130	 220	 200	
	E32-T22R		E32-T222	E32-T22B	
(side-view) 	3 dia.	 210	 460		
	E32-T14LR		E32-T14L		
	1 dia.	 50	 130		
	E32-T24R		E32-T24		
Flat (top-view) 	15 x 8 x 3	 530	 760	 680	
	E32-T15XR		E32-T15X	E32-T15XB	
	12 x 7 x 2	 130	 220	 150	
	E32-T25XR		E32-T25X	E32-T25XB	
(side-view) 	15 x 8 x 3	 210	 460		
	E32-T15YR		E32-T15Y		
	12 x 7 x 2	 50	 130		
	E32-T25YR		E32-T25Y		
(flat-view) 	15 x 8 x 3	 210	 460		
	E32-T15ZR		E32-T15Z		
	12 x 7 x 2	 50	 130		
	E32-T25ZR		E32-T25Z		
Right Angle (side-view) 	M4	 350			
	E32-T11N				

Note 1. The sensing distances apply for use in combination with the E3X-DA-S Amplifier Unit (general-purpose, standard mode).







Standard Models

Overview of Model Variations

Sensing distance (mm)
(See note 1.)

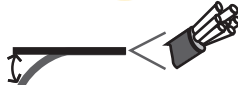
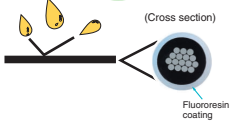
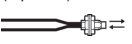
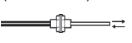
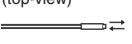
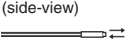
Model

Fiber Units with Reflective Sensors

Type (See note 2.)		Flexible (New Standard) <i>R</i>	Standard	Break-resistant <i>B</i>	Fluorine coating <i>U</i>
Shape of head		 Flexible and pliable		 Withstands repeated bending	 Cable protected against oil
Screw-shaped (top-view) 	M6	170	300	170	170
	E32-D11R	E32-DC200	E32-D11	E32-D11U	
	M3	30	80	30	
	E32-D21R	E32-DC200E	E32-D21		
(with sleeve) 	M4 (2.5-dia. sleeve)	170	300		
	E32-DC200BR	E32-DC200B			
	M3 (1.2-dia. sleeve)	30	80		
	E32-DC200FR	E32-DC200F			
Cylindrical (top-view) 	3 dia.	170	230	70	
	E32-D12R	E32-D12	E32-D221B		
	3 dia. (1.5 dia.)	30	80	30	
	E32-D22R	E32-D22	E32-D22B		
(side-view) 	6 dia.	45	110		
	E32-D14LR	E32-D14L			
	2 dia.	15	30		
	E32-D24R	E32-D24			
Flat (top-view) 	15 x 10 x 3	170	300	170	
	E32-D15XR	E32-D15X	E32-D15XB		
	12 x 7 x 2	30	80	50	
	E32-D25X	E32-D25X	E32-D25XB		
(side-view) 	15 x 10 x 3	40	100		
	E32-D15YR	E32-D15Y			
	12 x 8 x 2	8	20		
	E32-D25YR	E32-D25Y			
(flat-view) 	15 x 10 x 3	40	100		
	E32-D15ZR	E32-D15Z			
	12 x 8 x 2	8	20		
	E32-D25ZR	E32-D25Z			
Right Angle (side-view) 	M6	170			
	E32-D11N				

Note 1. The sensing distances apply for use in combination with the E3X-DA-S Amplifier Unit (general-purpose, standard mode).

Special-beam Models

Long Distance, High Power

- Powerful beam reduces influence of dust and dirt.
- Long sensing distance enables use in large-scale installations.



E32-T14

Applications

Detecting parts inside (translucent) containers

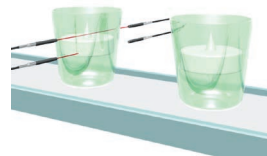

E32-T11L

Detecting workpieces in coating processes



E32-T17L

Ratings/Characteristics

Ambient temperature	-40°C to 70°C (no icing or condensation)
Fiber material	Plastic Free-cut

Overview of Model Variations

Type	Features	Shape, sensing distance (mm)*	Model number
Through-beam	Equipped with large lens	20,000	E32-T17L
	Side-view, screw mounting	3,400	E32-T14
	M4 screw	1,330	E32-T11L
Reflective	Equipped with large lens	700	E32-D16
	M6 screw	400	E32-D11L

Ultracompact, Ultrafine Sleeve

- Ultracompact head can be installed in tight spaces.
- Ultrafine sleeve ensures reliable detection of small objects, such as electronic components.



Applications

Alignment inspections

E32-D33

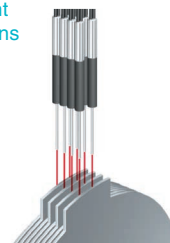

Detection of terminals

E32-T33-S5



Ratings/Characteristics

Min. sensing object	0.005-mm dia.
Ambient temperature	-40°C to 70°C (no icing or condensation)
Material	Plastic

Overview of Model Variations

Type	Features	Shape, sensing distance (mm)*	Model number
Through-beam	1-dia. cylinder	130	E32-T223R
	0.5-dia. sleeve (0.25-dia. opening)	44	E32-T33-S5
	0.22-dia. sleeve (0.1-dia. opening)	5	E32-T334-S5
Reflective	0.8-dia. sleeve	16	E32-D33
	0.5-dia. sleeve	3	E32-D331

*The sensing distances apply for use in combination with the E3X-DA-S Amplifier Unit (general-purpose, standard mode).

Special-beam Models

Coaxial, Small Spot

- Small spot diameter (0.1 mm min. in diameter) enables the reliable detection of small workpieces.
- Use of red light ensures easy visual recognition and simple positioning.

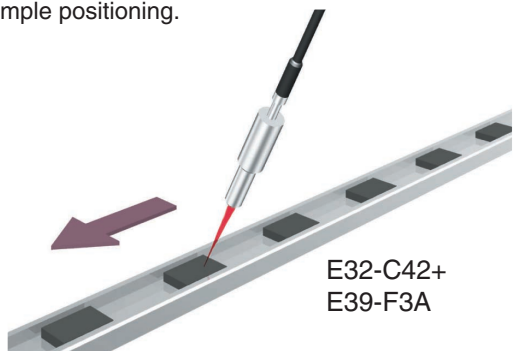

Applications

Detecting of CDs

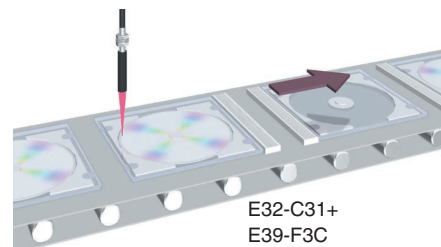

Ratings/Characteristics

Min. sensing object	0.005-mm dia.
Ambient temperature	-40°C to 70°C (no icing or condensation)
Fiber material	Plastic

Overview of Model Variations

Type	Features	Shape, sensing distance (mm)*	Model number
Coaxial, reflective	Coaxial, M6 screw	300	E32-CC200
	Coaxial, 3-dia. cylinder	150	E32-D32L
	Small spot	0.1-dia. spot at a distance of 7 mm	E32-C41+ E39-F3A-5
	Small variable spot	Spot diameter variable in the range 0.1 to 0.6 mm at distances in the range 6 to 15 mm	E32-C42+ E39-F3A
	Long distance, small spot	0.5-dia. spot at 17 mm	E32-C31+ E39-F3B
	Long distance, parallel light	Spot diameter of 4 mm max. at distances in the range 0 to 20 mm	E32-C31+ E39-F3C

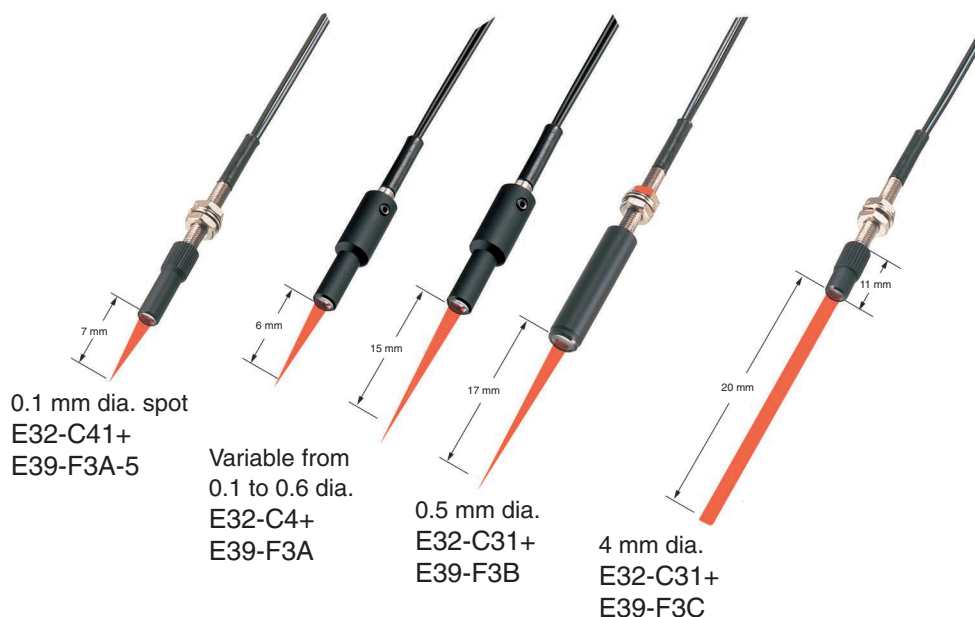

*The sensing distances apply for use in combination with the E3X-DA-S Amplifier Unit (general-purpose, standard mode).

Special-beam Models

Fine Beam (Narrow Vision Field)

- Fine beam reduces unwanted light in surrounding area.
- Powerful beam allows use in applications requiring a long sensing distance.

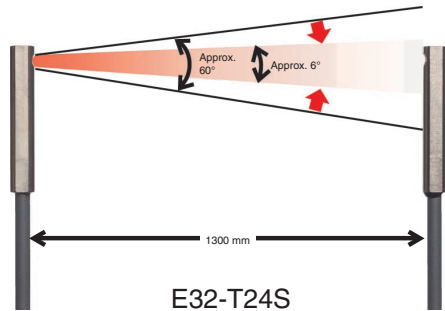

E32-T24S

Applications

Alignment inspection of orientation flats

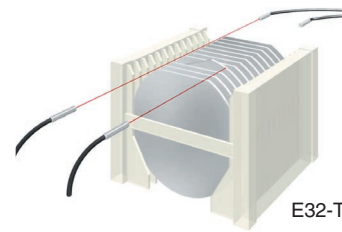

E32-T22S

Ratings/Characteristics

Min. bending radius	10 mm
Ambient temperature	-40°C to 70°C (no icing or condensation)
Fiber material	Plastic Free-cut

Overview of Model Variations

Type	Features	Shape, sensing distance (mm)*	Model number
Through-beam	Top-view	1,900	E32-T22S
	Side-view	1,300	E32-T24S

Area Sensing

- These Fiber Units ensure greater reliability with the detection of position inconsistencies in passing workpieces and the presence of workpieces with holes.
- Wide sensing bands of 11 and 30 mm (through-beam models) enable the detection of large position inconsistencies.

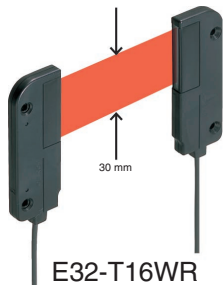

E32-T16WR

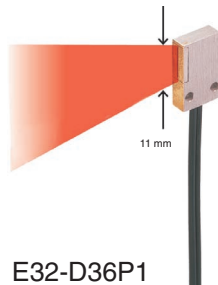

E32-D36P1

Applications

Detecting passage of candies

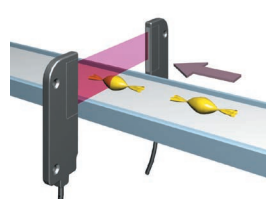

E32-T16WR

Detecting chips on film

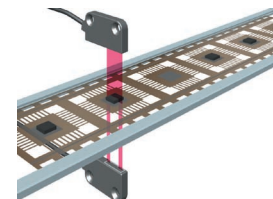

E32-T16R

Ratings/Characteristics

Ambient temperature	-40°C to 70°C (no icing or condensation) E32-T16W□ only: -25°C to 55°C
Fiber material	Plastic Free-cut

Overview of Model Variations

Type	Features	Shape, sensing distance (mm)*	Model number
Through-beam	Sensing width: 11 mm	840	E32-T16PR
	Sensing width: 11 mm Flat-view	750	E32-T16JR
	Sensing width: 30 mm	1,300	E32-T16WR
Reflective	Beam width: 11 mm	150	E32-D36P1

*The sensing distances apply for use in combination with the E3X-DA-S Amplifier Unit (general-purpose, standard mode).

Special-beam Models

Retroreflective

- The return optical path ensures that more light is interrupted by transparent workpieces than with through-beam models.
- Equipped with MSR function to eliminate light reflection.

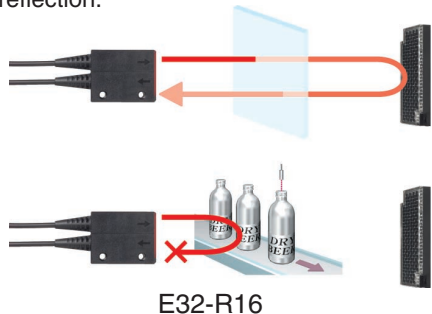

E32-R16

Applications

Detecting translucent medicine

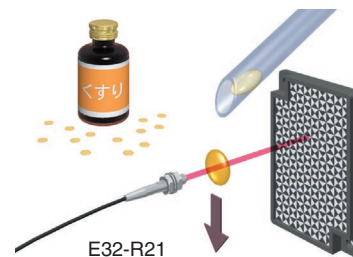

E32-R21

Ratings/Characteristics

Ambient temperature	E32-R21: -40°C to 70°C E32-R16: -25°C to 55°C (no icing or condensation)
Fiber material	Plastic Free-cut

Overview of Model Variations

Type	Features	Shape, sensing distance (mm)*	Model number
Retroreflective	MSR function, M6 screw	250	E32-R21
	MSR function, screw mounting, long distance	1,500	E32-R16

Limited-reflective

- Limited-reflective models eliminate light reflected from distant objects.
- Small level differences can be reliably detected.
- The optical-axis direction can be selected according to the installation space.



E32-L24L

Applications

Detecting connector pins

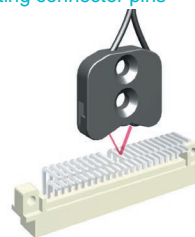

E32-L25L

Detecting wafers (glass substrates)

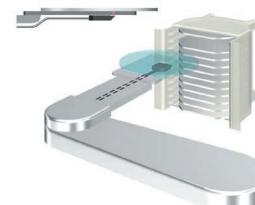

E32-L24L

Ratings/Characteristics

Min. sensing object	0.005-mm dia.
Fiber material	Plastic Free-cut 200°C models only: Glass

Overview of Model Variations

Type	Features	Shape, sensing distance (mm)*	Model number
Limited-reflective	Ultracompact, flat-view Ideal for checking stocks of glass substrates	0 to 4	E32-L24S
	Heat-resistant up to 105°C, top-view	5.4 to 9 (center: 7.2)	E32-L25L
	Wide sensing range flat-view	0 to 15	E32-L16
	Heat-resistant up to 200°C, flat-view	4 to 10	E32-L86

*The sensing distances apply for use in combination with the E3X-DA-S Amplifier Unit (general-purpose, standard mode).

Environment-resistive Models

Heat-resistant

- These Fiber Units can be used for various applications in temperatures up to 400°C.

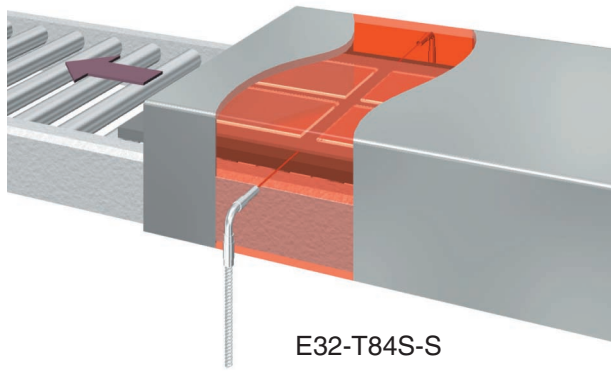

Applications

Detecting wafers in high-temperature environments

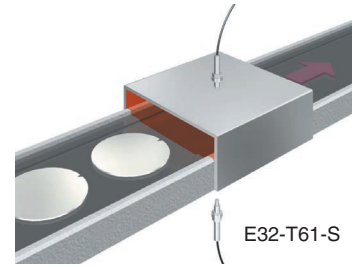

Ratings/Characteristics

	150°C models	200°C and higher models	
		E32-T81R E32-D81R	All other models
Min. bending radius	35 mm	10 mm	25 mm
Fiber material	Plastic (fluororesin coating) Free-cut	Glass (fluororesin coating)	Glass (SUS spiral coating)

Overview of Model Variations

Type	Ambient Temperature	Features	Shape, sensing distance (mm)*	Model number
Through-beam	-40°C to 150°C	M4 screw	760	E32-T51
	-40°C to 200°C	L-shaped, long distance	1,300	E32-T84S-S
	-60°C to 350°C	M4 screw	450	E32-T61-S
Reflective	-60°C to 350°C	M6 screw	90	E32-D61-S
	-40°C to 400°C	M6 screw, with sleeve	60	E32-D73-S

Chemical-resistant

- Built-in lens and high-power beam reduce the influence of dirt and drops of water.
- Round design prevents drops of water sticking to the head (E32-T11F).

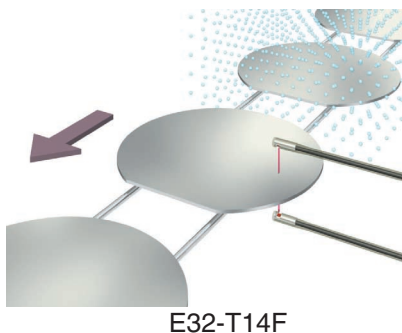

Applications

Detecting workpieces in cleaning processes

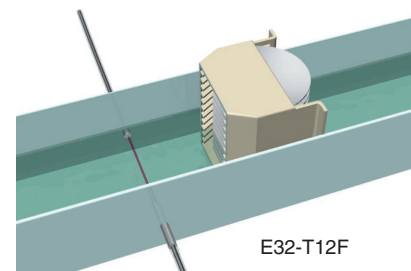

Ratings/Characteristics

	All other models	E32-T51F	E32-T81F-S
		Ambient temperature	-40°C to 70°C
Fiber material	Plastic (fluororesin coating) Free-cut		Glass (fluororesin coating)

Overview of Model Variations

Type	Features	Shape, sensing distance (mm)*	Model number
Through-beam	Water-resistant round head	2,000	E32-T11F
	Built-in lens, high power	3,000	E32-T12F
	Heat-resistant up to 200°C	700	E32-T81F-S
Reflective	Built-in lens, high power	95	E32-D12F

*The sensing distances apply for use in combination with the E3X-DA-S Amplifier Unit (general-purpose, standard mode).

Environment-resistive Models

Vacuum-resistant

- These models can be used in high-vacuum environments at pressures from 10^{-5} to 0.1 Pa.
- The 4-channel multi-flange, which has a maximum leakage rate of 1×10^{-10} Pa·m³/s, contributes to space savings.



Applications (Configuration Example)

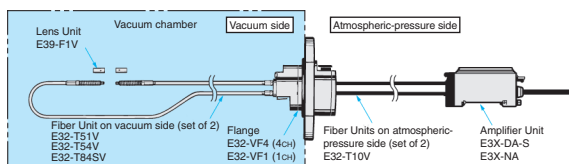

Ratings/Characteristics

	120°C models	200°C models	Atmospheric-pressure side
Min. bending radius	30 mm	25 mm	
Fiber material	Glass (fluororesin coating)	Glass (SUS spiral coating)	Plastic (fluororesin coating) Free-cut

Overview of Model Variations

Type	Features	Shape, sensing distance (mm)*	Model number
Through-beam	M4 screw, top-view, heat-resistant up to 120°C, long distance	1,000	E32-T51V 1M+ E39-F1V
	L-shaped, heat-resistant up to 120°C	130	E32-T54V 1M
	L-shaped, long distance, heat-resistant up to 200°C	480	E32-T84SV 1M

Fiber Units on Atmospheric-pressure Side

Appearance	Type	Model number
	Common	E32-T10V 2M

Flanges

Appearance	Type	Model number
	4-channel flange	E32-VF4
	1-channel flange	E32-VF1

Ratings/Characteristics

Number of channels		4 channels	1 channel
Item	Model number	E32-VF4	E32-VF1
Leakage rate	1×10 ⁻¹⁰ Pa·m ³ /s max.		
Ambient temperature	Operating: -25°C to 55°C Storage: -25°C to 55°C		
Material	Aluminum (A5056)		Stainless steel (SUS304) Aluminum (A5056)
Flange-seal material	Fluorocarbon rubber (Viton)		
Weight (packed state)	Approx. 280 g		Approx. 240 g

*The sensing distances apply for use in combination with the E3X-DA-S Amplifier Unit (general-purpose, standard mode).

Application-specific Models

Label Detection

- Built-in lens and high-power beam enable the reliable detection of labels through a mounting board.
- These Fiber Units can be washed with hydrogen peroxide, making them ideal for the food industry.



Applications

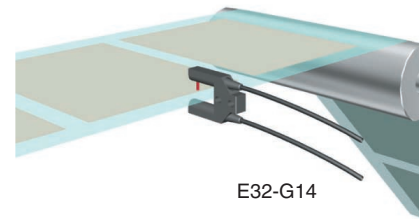

Detecting labels



Ratings/Characteristics

Ambient temperature	-40°C to 70°C (no icing or condensation)
Fiber material	Plastic Free-cut
Degree of protection	IP67

Overview of Model Variations

Type	Features	Shape, sensing distance (mm)*	Model number
Through-beam	Slot sensor, no adjustment of optical axis required	 10	E32-G14
	Screw mounting, side-view	 3,400	E32-T14

Liquid-level Detection

- Area sensing is possible with minimal influence from bubbles and drops of water (E32-A01/A02/D36T).
- For safety when disconnections occur, two models have been developed, a light ON model for liquid presence and a light ON model for liquid absence (E32-A01/A02).

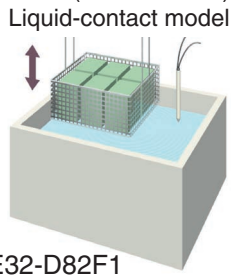

Operating Principle

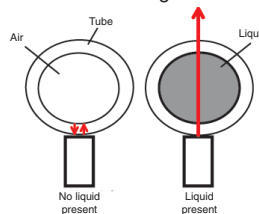

Liquid-contact model

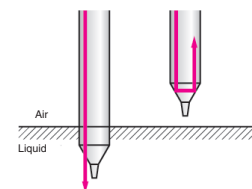

The presence/absence of liquid is detected using the refractive properties of light. More specifically, it utilizes the fact that the difference in refractive index between the air and the tip/tube is larger than the difference between the liquid and the tip/tube.

Overview of Model Variations

Type	Features	Shape, sensing distance (mm)*	Model number
Through-beam	Light ON when liquid is present (ideal for checking lower limits)	Applicable tube: Transparent tube with a diameter of 3.2, 6.4, or 9.5 mm and a recommended wall thickness of 1 mm	E32-A01
	Light ON when liquid is absent (ideal for checking for overflow)	Applicable tube: Transparent tube with a diameter in the range 6 to 13 mm and a recommended wall thickness of 1 mm	E32-A02
	No restriction on tube diameter, resistant to bubbles and drops of water	Applicable tube: Transparent tube (no restriction on diameter)	E32-D36T
Liquid-contact	Heat-resistant up to 200°C, shape prevents liquid buildup	Liquid-contact model	E32-D82F1

*The sensing distances apply for use in combination with the E3X-DA-S Amplifier Unit (general-purpose, standard mode).

Application-specific Models

Glass-substrate Alignment

- There is little variation of detection position within the detection range (± 0.1 mm max.)
- The different model variations can handle a variety of sensing distances and temperature conditions.

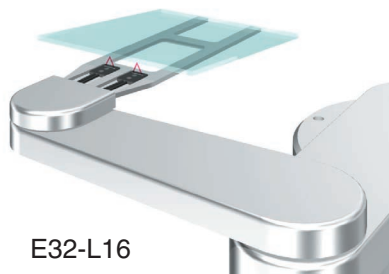

E32-L16

Engineering Data (E32-A07/A08/L16) Detection-Position Characteristics (Typical Examples)

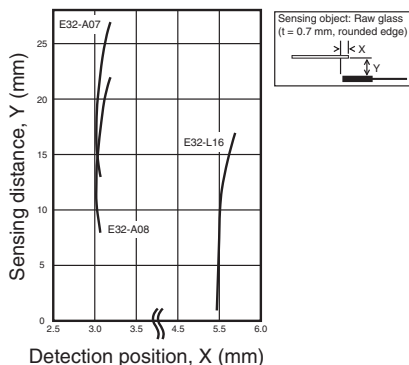

Overview of Model Variations

Type	Features	Shape, sensing distance (mm)*	Model number
Limited-reflective	0 to 15 mm, wide-range sensing	0 to 15	E32-L16
	Long-distance sensing	10 to 20	E32-A08
		15 to 25	E32-A07E1 E32-A07E2
	Heat-resistant up to 300°C	5 to 18	E32-L66

Glass-substrate Mapping

- These models can reliably detect thin glass-substrate end faces ($t = 0.5$ mm, beveled edge).
- Using a large-diameter lens makes it possible to cope with tilting of the glass substrates.

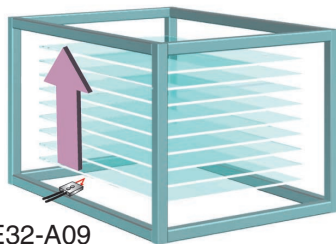

E32-A09

Engineering Data (E32-A09)

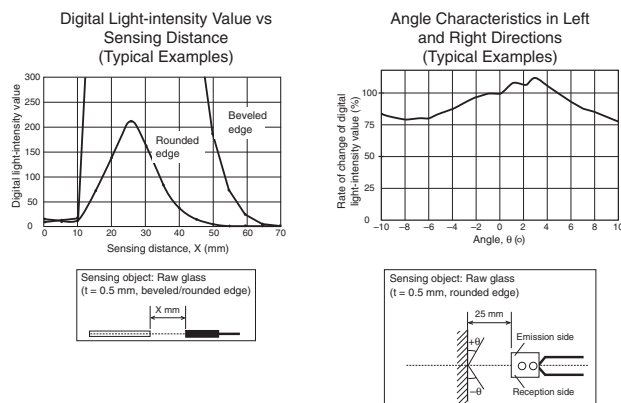

Overview of Model Variations

Type	Features	Shape, sensing distance (mm)*	Model number
Limited-reflective	Large-diameter lens ensures resistance to tilting	15 to 38 (center: 25)	E32-A09
	Heat-resistant up to 150°C		E32-A09H
	Heat-resistant up to 300°C	20 to 30 (center: 25)	E32-A09H2

*The sensing distances apply for use in combination with the E3X-DA-S Amplifier Unit (general-purpose, standard mode).

Application-specific Models

Wafer Mapping

- Wafers are reliably detected with an ultrafine beam.
- The optical axis is adjusted before delivery to allow easy installation.



■ Features

Optical axis adjusted before delivery so that displacement is typically within 0.1°.

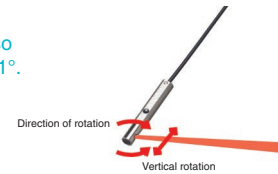

■ Engineering Data

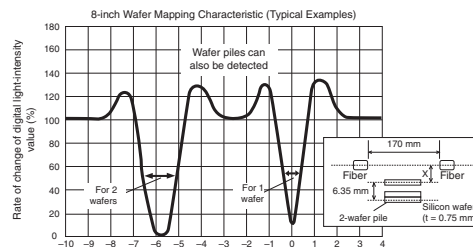

■ Overview of Model Variations

Type	Features	Shape, sensing distance (mm)*	Model number
Through-beam	Opening angle: 1.5°		E32-A03
	With mounting flange		E32-A03-1
	Opening angle: 3° ultraslim		E32-A04
	With mounting flange		E32-A04-1

True Color Detection

- Use E32 fiber units with E3X-DAC amplifiers (see page 79) to accurately detect all RGB wavelengths

Precise Color Detection

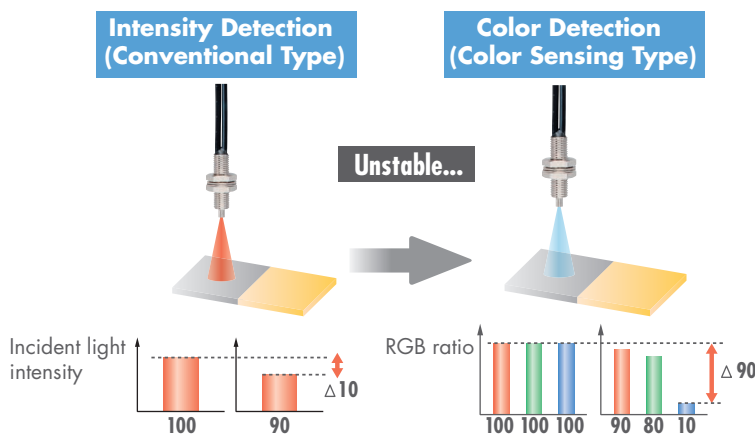

Color vs. Detection Capability

	White	Red	Yellow-red	Yellow	Yellow-green	Green	Blue-green	Blue	Blue-violet	Violet	Red-violet
White	○	○	○	○	○	○	○	○	○	○	○
Red	○	○	○	○	○	○	○	○	○	○	○
Yellow-red	○	○	○	○	○	○	○	○	○	○	○
Yellow	○	○	○	○	○	○	○	○	○	○	○
Yellow-green	○	○	○	○	○	○	○	○	○	○	○
Green	○	○	○	○	○	○	○	○	○	○	○
Blue-green	○	○	○	○	○	○	○	○	○	○	○
Blue	○	○	○	○	○	○	○	○	○	○	○
Blue-violet	○	○	○	○	○	○	○	○	○	○	○
Violet	○	○	○	○	○	○	○	○	○	○	○
Red-violet	○	○	○	○	○	○	○	○	○	○	○

No Need to Select Separate Red, Green, Blue LED Amplifiers

A high-power white LED and a multi-RGB processing system combine to cover all RGB wavelengths, enabling easy and accurate detection of workpieces without having to use a different light source to match each one.

Resists Movement

Changes in the three parameters are processed as a ratio, so they are not affected by light-intensity variations due to workpiece movement.

*The sensing distances apply for use in combination with the E3X-DA-S Amplifier Unit (general-purpose, standard mode).

Application-specific Models

■ Applications

Detecting Opaque Marks—Reflective

Because it distinguishes RGB ratios, detection is highly resistant to workpiece movement.



Detecting Translucent Marks

Detecting color differences in translucent marks on film with easy-to-install U-shaped sensing head.

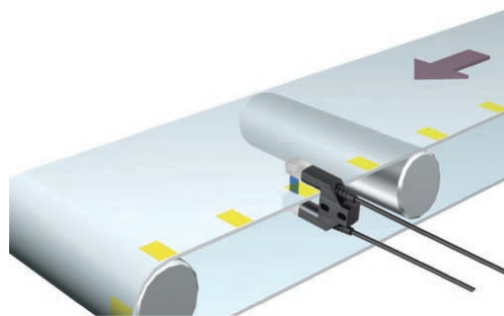

Distinguishing Products

Detection is highly resistant to the effects of backgrounds and surface protrusions.

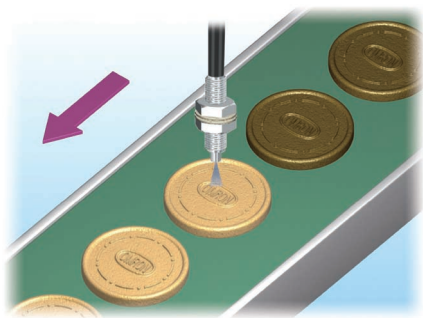

Distinguishing Trays

Twin sensing and remote control functions simplify setup of color sortation on a multi-product line.

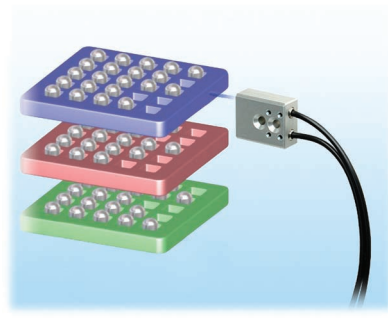

Distinguishing Semi-Transparent Objects

Through-beam Fiber Heads are capable of detecting color differences in semi-transparent objects.

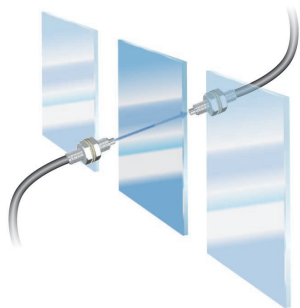

Detecting Wafers

Workpieces that absorb a specific wavelength can be detected with a wide range of wavelengths.

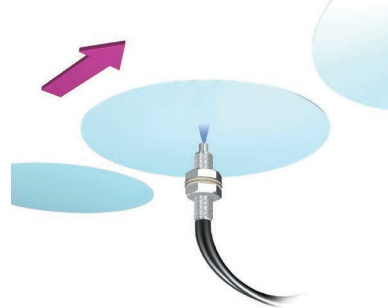

■ Overview of Model Variations

Type	Features	Shape	Sensing distance (mm)*		Model number
			Opaque object	Translucent object	
Through-beam	M4 screw		110	22	E32-T11R
	Long distance		3,200	600	E32-T17L
Reflective	Long distance		70	13	E32-D11L
	Coaxial, M6 screw		45	9	E32-CC200

*The sensing distances apply for use in combination with the E3X-DAC-S Amplifier Unit (general-purpose, standard mode).

Ordering Information

Through-beam Fiber Units





*1. The values for the minimum sensing object are representative values that indicate values obtained in standard mode with the sensing distance and sensitivity set to optimum values.

*2. **Free-cut** Indicates models that allow free cutting.

High-resolution mode **Standard mode** **Super-high-speed mode**. When used in combination with the E3X-DA-S Amplifier Unit (general-purpose).

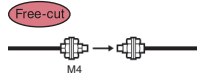
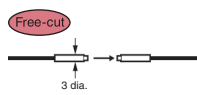
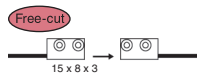
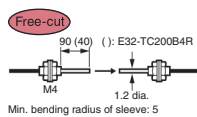
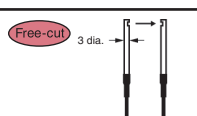
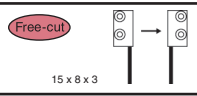
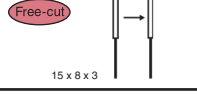
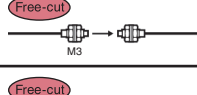
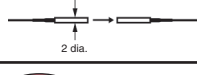
High-resolution mode **Standard mode** **Super-high-speed mode**. When used in combination with the E3X-MDA Unit.

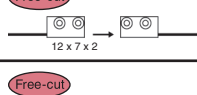
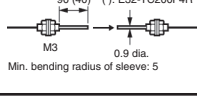
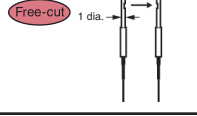
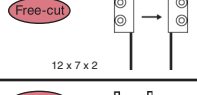
When used in combination with E3X-NA-F high speed unit. **When used in combination with E3X-NA or E3X-SD standard units.**

Type	Appearance (mm) *2	Sensing distance (mm)	Standard object (min. sensing object) (mm) *1	Min. bending radius (mm)	Features	Model number				
Standard models	Standard size	Free-cut 	1 dia. (0.005 dia.)	R1	M4 screw	E32-T11R				
		Free-cut 			700 530 140	3-dia. cylinder	E32-T12R			
		Free-cut 			450 350 140	Flat shape	E32-T15XR NEW			
		Free-cut 			280 80	M4 screw, with 90 mm sleeve	E32-TC200BR			
		Free-cut 				M4 screw, with 40 mm sleeve	E32-TC200B4R NEW			
		Free-cut 			270 210 50	3-dia. cylinder, side-view	E32-T14LR			
		Free-cut 			170 130 50	Flat shape, side-view	E32-T15YR NEW			
		Free-cut 			110 33	Flat shape, flat-view	E32-T15ZR NEW			
		Flexible (new standard)			Small size	Free-cut 	0.5 dia. (0.005 dia.)	R1	M3 screw (small)	E32-T21R
						Free-cut 			160 130	2-dia. cylinder (small)
	Free-cut 		30 100 75	1.5-dia. cylinder (small)		E32-T222R NEW				
	Free-cut 		30 60 18	Flat shape (small)		E32-T25XR NEW				
	Free-cut 			M3 screw (small), with 90 mm sleeve		E32-TC200FR				
	Free-cut 			M3 screw (small), with 40 mm sleeve		E32-TC200F4R NEW				
	Free-cut 		60 50 10	1-dia. cylinder (small), side-view		E32-T24R				
	Free-cut 		35 27 10	Flat shape (small), side-view		E32-T25YR NEW				
	Free-cut 		30 9	Flat shape (small), flat-view		E32-T25ZR NEW				

R: Flexible fiber **B**: Bendable fiber **U**: Fluorine-coated fiber

Through-beam Fiber Units







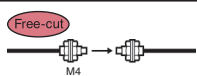

*1. The values for the minimum sensing object are representative values that indicate values obtained in standard mode with the sensing distance and sensitivity set to optimum values.

*2. **Free-cut** Indicates models that allow free cutting.

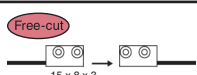
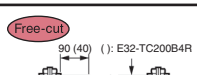
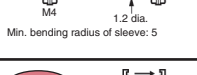
High-resolution mode **Standard mode** **Super-high-speed mode**. When used in combination with the E3X-DA-S Amplifier Unit (general-purpose).

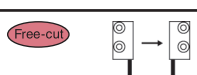
High-resolution mode **Standard mode** **Super-high-speed mode**. When used in combination with the E3X-MDA Unit.

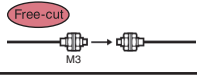
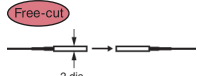
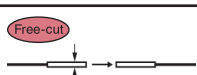
When used in combination with E3X-NA-F high speed unit. **When used in combination with E3X-NA or E3X-SD standard units.**

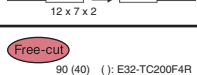
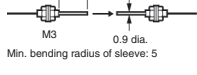
Type	Appearance (mm) *2	Sensing distance (mm)	Standard object (min. sensing object) (mm) *1	Min. bending radius (mm)	Features	Model number	
Standard models	Standard size	 M4		1 dia. (0.005 dia.)	R25	M4 screw	E32-TC200
		 M4	1,000 760 200			3-dia. cylinder	E32-T12 NEW
		 15 x 8 x 3	650 500 200			Flat shape	E32-T15X NEW
		 90 (40) (): E32-TC200B4R M4 1.2 dia. Min. bending radius of sleeve: 5	400 120			M4 screw, with 90 mm sleeve	E32-TC200B
		 M4 1.2 dia. Min. bending radius of sleeve: 5	400 120			M4 screw, with 40 mm sleeve	E32-TC200B4
		 3 dia.	600 460 120			3-dia. cylinder, side-view	E32-T14L
		 15 x 8 x 3	390 300 120			Flat shape, side-view	E32-T15Y NEW
		 15 x 8 x 3	240 70			Flat shape, flat-view	E32-T15Z NEW
		 M3	900 680 180 580 450 180 360 100			M3 screw (small)	E32-TC200A
	Small size	 M3		0.5 dia. (0.005 dia.)	R10		E32-TC200E
		 2 dia.	270 220			2-dia. cylinder (small)	E32-T22
		 1.5 dia.	50 170 130			1.5-dia. cylinder (small)	E32-T222 NEW
		 12 x 7 x 2	50 100 30			Flat shape (small)	E32-T25X NEW
		 90 (40) (): E32-TC200F4R M3 0.9 dia. Min. bending radius of sleeve: 5				M3 screw (small), with 90 mm sleeve	E32-TC200F
		 M3 0.9 dia. Min. bending radius of sleeve: 5				M3 screw (small), with 40 mm sleeve	E32-TC200F4

R : Flexible fiber **B** : Bendable fiber **U** : Fluorine-coated fiber

Ordering Information

Through-beam Fiber Units

*1. The values for the minimum sensing object are representative values that indicate values obtained in standard mode with the sensing distance and sensitivity set to optimum values.

*2. **Free-cut** Indicates models that allow free cutting.

High-resolution mode Standard mode Super-high-speed mode. When used in combination with the E3X-DA-S Amplifier Unit (general-purpose).

High-resolution mode Standard mode Super-high-speed mode. When used in combination with the E3X-MDA Unit.

When used in combination with E3X-NA-F high speed unit. When used in combination with E3X-NA or E3X-SD standard units.

Type	Appearance (mm) *2	Sensing distance (mm)	Standard object (min. sensing object) (mm) *1	Min. bending radius (mm)	Features	Model number		
Standard models	Standard	Small size 1 dia.	160 130 30	0.5 dia. (0.005 dia.)	R10	1-dia. cylinder (small), side-view	E32-T24	
			100 70 30			Flat shape (small), side-view	E32-T25Y NEW	
			90 27			Flat shape (small), flat-view	E32-T25Z NEW	
	Break-resistant	Standard size M4	3 dia.	900 680 180	1 dia (0.005 dia.)	R4	M4 screw	E32-T11
				580 450 180			3-dia. cylinder	E32-T12B NEW
				360 100			Flat shape	E32-T15XB NEW
		Small size M3	2 dia.	240 200 45			M3 screw (small)	E32-T21
				150 110 45			2-dia. cylinder (small)	E32-T221B NEW
				100 30			1.5-dia. cylinder (small)	E32-T22B NEW
	Small size 12 x 7 x 2	1.5 dia	180 150 35	0.5 dia (0.005 dia.)		Flat shape (small)	E32-T25XB NEW	
			125 95 35					
			75 20					
Standard	Right angle M4		700 530 140 450 350 140 280 80	1 dia (0.005 dia.)	R1	M4 screw, right angle	E32-T11N NEW	



: Flexible fiber : Bendable fiber : Fluorine-coated fiber

Through-beam Fiber Units









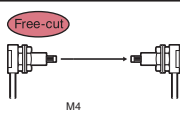
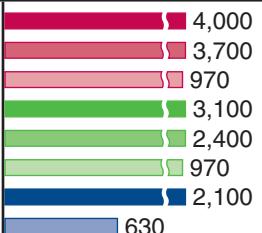

*1. The values for the minimum sensing object are representative values that indicate values obtained in standard mode with the sensing distance and sensitivity set to optimum values.

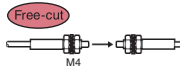
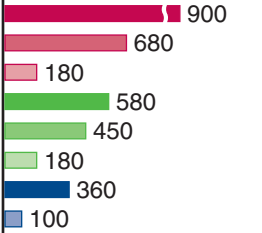
*2.  Indicates models that allow free cutting.

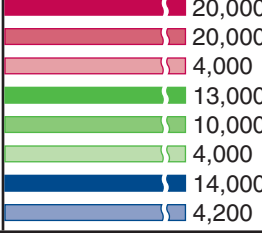
 High-resolution mode  Standard mode  Super-high-speed mode. When used in combination with the E3X-DA-S Amplifier Unit (general-purpose).

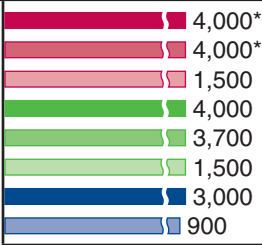
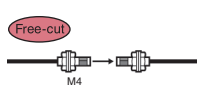
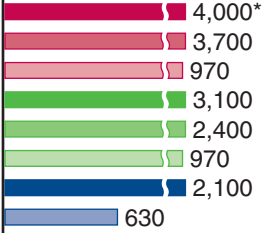

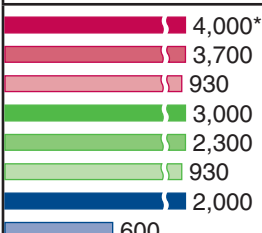
 High-resolution mode  Standard mode  Super-high-speed mode. When used in combination with the E3X-MDA Unit.

 When used in combination with E3X-NA-F high speed unit.  When used in combination with E3X-NA or E3X-SD standard units.

Type	Appearance (mm) *2	Sensing distance (mm)	Standard object (min. sensing object) (mm) *1	Min. bending radius (mm)	Features	Model number
Standard models	Standard Right angle 	 4,000 3,700 970 3,100 2,400 970 2,100 630	4 dia (0.005 dia.)	 R1	M4 screw, right angle, long distance	E32-T11N+ E39-F1 <i>NEW</i>
	Chemical resistant Standard size 	 900 680 180 580 450 180 360 100	1 dia (0.005 dia.)	 R4	M4 screw, fluorine coating	E32-T11U
Special-beam models	Long-distance, high-power 	 20,000*3 20,000*3 4,000 13,000 10,000 4,000 14,000 4,200	10 dia.	R25	Large built-in lens, M14 screw	E32-T17L
		 4,000*4 4,000*4 1,500 4,000 3,700 1,500 3,000 900			M4 screw	E32-TC200+ E39-F1
		 4,000*4 3,700 970 3,100 2,400 970 2,100 630	4 dia. (0.1 dia.)	 R1	M4 screw, flexible fiber	E32-T11R+ E39-F1
		 4,000*4 3,700 930 3,000 2,300 930 2,000 600		 R4	M4 screw, break-resistant	E32-T11+ E39-F1

*3. The optical fiber is 10 m long on each side permitting a sensing distance of 20,000 mm.

*4. The optical fiber is 2 m long on each side permitting a sensing distance of 4,000 mm.

 : Flexible fiber  : Bendable fiber  : Fluorine-coated fiber

Ordering Information

Through-beam Fiber Units

*1. The values for the minimum sensing object are representative values that indicate values obtained in standard mode with the sensing distance and sensitivity set to optimum values.

*2. **Free-cut** Indicates models that allow free cutting.

High-resolution mode **Standard mode** **Super-high-speed mode**. When used in combination with the E3X-DA-S Amplifier Unit (general-purpose).

High-resolution mode **Standard mode** **Super-high-speed mode**. When used in combination with the E3X-MDA Unit.

When used in combination with E3X-NA-F high speed unit. **When used in combination with E3X-NA or E3X-SD standard units.**

Type	Appearance (mm) *2	Sensing distance (mm)	Standard object (min. sensing object) (mm) *1	Min. bending radius (mm)	Features	Model number	
Special-beam models Long-distance, high-power	Free-cut 	<ul style="list-style-type: none"> 4,000*3 3,400 900 2,900 2,200 900 1,800 540 	4 dia. (0.1 dia.)	R25	Screw mounting, side view	E32-T14	
	Free-cut 	<ul style="list-style-type: none"> 1,700 1,330 350 1,100 870 350 700 210 	1.4 dia. (0.01 dia.)		M4 screw	E32-T11L	
	Free-cut 	<ul style="list-style-type: none"> 350 700 210 			3-dia. cylinder	E32-T12L	
			<ul style="list-style-type: none"> 910 800 180 600 520 180 220 65 	3 dia. (0.1 dia.)	R1	M4 screw, side-view	E32-T11L+ E39-F2
			<ul style="list-style-type: none"> 520 400 100 330 260 100 220 65 			M4 screw, side-view, flexible fiber	E32-T11R+ E39-F2
			<ul style="list-style-type: none"> 820 660 160 530 430 160 360 100 		R4	M4 screw, side-view, break-resistant	E32-T11+ E39-F2
			<ul style="list-style-type: none"> 540 440 100 340 260 100 200 60 		R10	M3 screw (small)	E32-T21L
	Free-cut 	<ul style="list-style-type: none"> 100 200 60 	2-dia. cylinder (small)	E32-T22L			

*3. The optical fiber is 2 m long on each side permitting a sensing distance of 4,000 mm.

R: Flexible fiber **B**: Bendable fiber **U**: Fluorine-coated fiber

Through-beam Fiber Units





*1. The values for the minimum sensing object are representative values that indicate values obtained in standard mode with the sensing distance and sensitivity set to optimum values.

*2. **Free-cut** Indicates models that allow free cutting.

High-resolution mode **Standard mode** **Super-high-speed mode**. When used in combination with the E3X-DA-S Amplifier Unit (general-purpose).

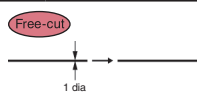
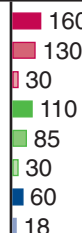
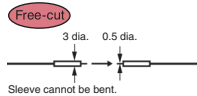
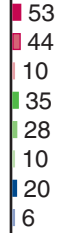
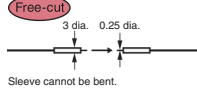
High-resolution mode **Standard mode** **Super-high-speed mode**. When used in combination with the E3X-MDA Unit.

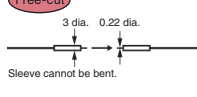
When used in combination with E3X-NA-F high speed unit. **When used in combination with E3X-NA or E3X-SD standard units.**

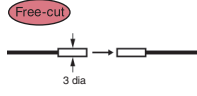
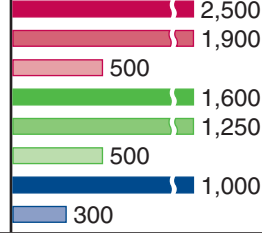
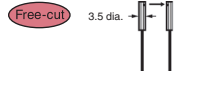
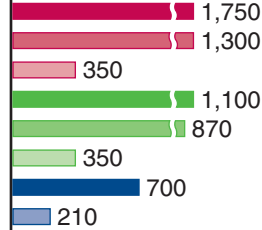
Type	Appearance (mm) *2	Sensing distance (mm)	Standard object (min. sensing object) (mm) *1	Min. bending radius (mm)	Features	Model number	
Special-beam models	Ultracompact, thin-sleeve 	 160 130 30 110 85 30 60 18	0.5 dia. (0.005 dia.)	R R1	1-dia. cylinder, flexible fiber	E32-T223R NEW	
		 Sleeve cannot be bent.	 53 44 10 35 28 10 20 6	0.25 dia. (0.005 dia.)	R10	0.5-dia. sleeve; 0.25-dia. opening	E32-T33-S5 NEW
		 Sleeve cannot be bent.	 12 10 4 8 6 4 5 1.5	0.125 dia. (0.005 dia.)		0.25-dia. sleeve; 0.125-dia. opening	E32-T333-S5 NEW
		 Sleeve cannot be bent.	 6 5 2 4 3 2 2.5 0.8	0.1 dia. (0.005 dia.)		0.22-dia. sleeve; 0.1-dia. opening	E32-T334-S5 NEW
	Fine-beam 	 2,500 1,900 500 1,600 1,250 500 1,000 300	1.7 dia. (0.1 dia.)	R10	3-dia. cylinder	E32-T22S	
	 1,750 1,300 350 1,100 870 350 700 210	2 dia. (0.1 dia.)	3.5-dia. cylinder, side-view		E32-T24S		

R : Flexible fiber **B** : Bendable fiber **U** : Fluorine-coated fiber

Ordering Information

Through-beam Fiber Units

*1. The values for the minimum sensing object are representative values that indicate values obtained in standard mode with the sensing distance and sensitivity set to optimum values.

*2. **Free-cut** Indicates models that allow free cutting.

High-resolution mode Standard mode Super-high-speed mode. When used in combination with the E3X-DA-S Amplifier Unit (general-purpose).

High-resolution mode Standard mode Super-high-speed mode. When used in combination with the E3X-MDA Unit.

When used in combination with E3X-NA-F high speed unit. When used in combination with E3X-NA or E3X-SD standard units.

Type	Appearance (mm) *2	Sensing distance (mm)	Standard object (min. sensing object) (mm) *1	Min. bending radius (mm)	Features	Model number										
Special-beam models Area-sensing		1,100 840 220 730 560 220 450 130	(0.2 dia.) *3	 R1	Area width: 11 mm	E32-T16PR										
		1,500 1,100 300 970 750 300 600 180					R10	E32-T16P								
		980 750 190 600 480 190 390 110							 R1	Area width: 11 mm; side-view	E32-T16JR					
		1,300 1,000 260 800 650 260 520 150										R10	E32-T16J			
		1,700 1,300 340 1,100 860 340 690 200												 R1	Area width: 30 mm	E32-T16WR
		2,300 1,800 450 1,400 1,100 450 920 270														

*3. This is the value for which detection is possible within the sensing area, with the sensing distance set to 300 mm. (The sensing object is stationary.)

: Flexible fiber : Bendable fiber : Fluorine-coated fiber

Through-beam Fiber Units



*1. The values for the minimum sensing object are representative values that indicate values obtained in standard mode with the sensing distance and sensitivity set to optimum values.

*2. **Free-cut** Indicates models that allow free cutting.

High-resolution mode Standard mode Super-high-speed mode. When used in combination with the E3X-DA-S Amplifier Unit (general-purpose).

High-resolution mode Standard mode Super-high-speed mode. When used in combination with the E3X-MDA Unit.

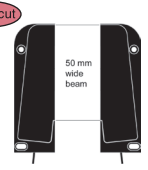
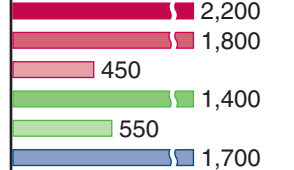
When used in combination with E3X-NA-F high speed unit. When used in combination with E3X-NA or E3X-SD standard units.

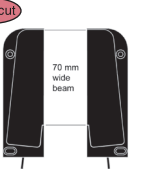
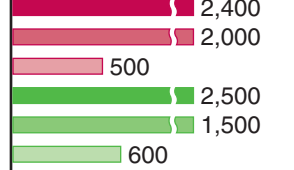
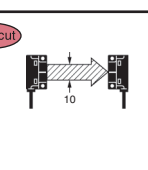
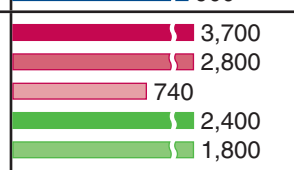
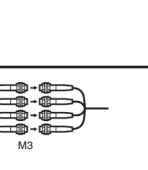
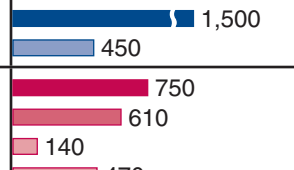
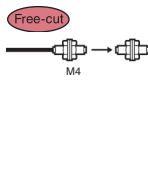
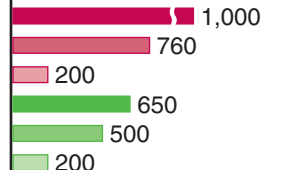
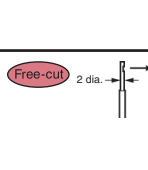
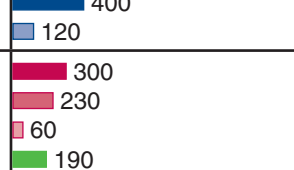
Type	Appearance (mm) *2	Sensing distance (mm)	Standard object (min. sensing object) (mm) *1	Min. bending radius (mm)	Features	Model number	
Special-beam models	Area-sensing	 50 mm wide beam	 2,200 1,800 450 1,400 550 1,700	(5 dia.) *4	 R1	Area width: 50 mm	E32-ET16WR-2 <i>NEW</i>
		 70 mm wide beam	 2,400 2,000 500 2,500 1,500 600 900				
		 10 mm wide beam	 3,700 2,800 740 2,400 1,800 740 1,500 450	2 dia. (0.1 dia.)	R25	Area width: 10 mm; long distance	E32-T16
		 M3	 750 610 140 470 360 140 300 90			Multi-point detection (4-head)	E32-M21
Environment-resistive models	Heat-resistant 150°C*5	 M4	 1,000 760 200 650 500 200 400 120	1.5 dia. (0.1 dia.)	R35	Heat-resistant up to 150°C	E32-T51
		 2 dia.	 300 230 60 190 150 60 130 35			Heat-resistant up to 150°C; side-view	E32-T54

*4. This is the value for which detection is possible within the sensing area, with the sensing distance set to give a digital value of 1,000. (The sensing object is stationary.)

*5. For continuous operation, use the products within a temperature range of -40°C to 130°C.

: Flexible fiber : Bendable fiber : Fluorine-coated fiber

Ordering Information

Through-beam Fiber Units

*1. The values for the minimum sensing object are representative values that indicate values obtained in standard mode with the sensing distance and sensitivity set to optimum values.

*2. **Free-cut** Indicates models that allow free cutting.

High-resolution mode Standard mode Super-high-speed mode. When used in combination with the E3X-DA-S Amplifier Unit (general-purpose).

High-resolution mode Standard mode Super-high-speed mode. When used in combination with the E3X-MDA Unit.

When used in combination with E3X-NA-F high speed unit. When used in combination with E3X-NA or E3X-SD standard units.

Type	Appearance (mm) *2	Sensing distance (mm)	Standard object (min. sensing object) (mm) *1	Min. bending radius (mm)	Features	Model number	
Environment-resistant models	Heat-resistant	200°C	M4 360, 280, 70, 230, 180, 70, 180, 50	1 dia. (0.005 dia.)	R10	Heat-resistant up to 200°C *3	E32-T81R-S
		M4 600, 450, 120, 230, 180, 70, 180, 50	3 dia. (0.1 dia.)	R25	Heat-resistant up to 200°C *3; side-view	E32-T61-S+ E39-F2	
		M4 4,000*4, 3,400, 900, 3,000, 2,200, 900, 3,000, 900	4 dia. (0.1 dia.)		Heat-resistant up to 200°C *3, long distance	E32-T61-S+ E39-F1	
		3 dia. 1,750, 1,300, 350, 1,100, 870, 350, 700, 210	1.7 dia. (0.1 dia.)	Heat-resistant up to 200°C *3; L-shaped; long distance	E32-T84S-S		
	350°C	M4 600, 450, 120, 390, 300, 120, 900, 90	1 dia. (0.005 dia.)	Heat-resistant up to 350°C *3	E32-T61-S		
Chemical-resistant	7.2 dia. 2,500, 2,000, 520, 1,600, 1,300, 520, 1,050, 380	4 dia. (0.1 dia.)	R4	Fluororesin cover, round head	E32-T11F		

*3. The maximum temperature that can be withstood varies with the location. Refer to dimensions diagrams for details.

*4. The optical fiber is 2 m long on each side permitting a sensing distance of 4,000 mm.

: Flexible fiber : Bendable fiber : Fluorine-coated fiber

Through-beam Fiber Units

*1. The values for the minimum sensing object are representative values that indicate values obtained in standard mode with the sensing distance and sensitivity set to optimum values.

*2. **Free-cut** Indicates models that allow free cutting.

High-resolution mode Standard mode Super-high-speed mode. When used in combination with the E3X-DA-S Amplifier Unit (general-purpose).

High-resolution mode Standard mode Super-high-speed mode. When used in combination with the E3X-MDA Unit.

When used in combination with E3X-NA-F high speed unit. When used in combination with E3X-NA or E3X-SD standard units.

Type	Appearance (mm) *2	Sensing distance (mm)	Standard object (min. sensing object) (mm) *1	Min. bending radius (mm)	Features	Model number	
Environment-resistant models	Chemical-resistant		4,000*3 3,000 800 2,600 2,000 800 1,600 480	4 dia. (0.1 dia.)	R40	Fluororesin cover, long distance	E32-T12F
			500 400 100 320 250 100 200 60	3 dia. (0.1 dia.)		Fluororesin cover, side-view	E32-T14F
		1,800 1,400 350 1,190 920 350 700 200	4 dia. (0.1 dia.)	Fluororesin cover, heat-resistant up to 150°C *4		E32-T51F NEW	
		920 700 190 600 460 190 350 100	1 dia. (0.005 dia.)	Fluororesin cover, heat-resistant up to 200°C *5		E32-T81F-S	
Vacuum-resistant		260 200 50 170 130 50 100	1.2 dia. (0.01 dia.)	R30	M4 screw, heat-resistant up to 120°C	E32-T51V 1M	
		1,350 1,000 260 850 650 260 600	4 dia. (0.1 dia.)		M4 screw, heat-resistant up to 120°C, long distance	E32-T51V 1M+ E39-F1V	

*3. 2 m long on each side permitting a sensing distance of 4,000 mm.

*4. For continuous operation, use the product within a range of -40° to 130°C.

*5. The maximum temperature that can be withstood varies with location. Refer to dimensions diagrams for details.

: Flexible fiber : Bendable fiber : Fluorine-coated fiber

Ordering Information

Through-beam Fiber Units

*1. The values for the minimum sensing object are representative values that indicate values obtained in standard mode with the sensing distance and sensitivity set to optimum values.

*2. **Free-cut** Indicates models that allow free cutting.

High-resolution mode Standard mode Super-high-speed mode. When used in combination with the E3X-DA-S Amplifier Unit (general-purpose).

High-resolution mode Standard mode Super-high-speed mode. When used in combination with the E3X-MDA Unit.

When used in combination with E3X-NA-F high speed unit. When used in combination with E3X-NA or E3X-SD standard units.

Type	Appearance (mm) *2	Sensing distance (mm)	Standard object (min. sensing object) (mm) *1	Min. bending radius (mm)	Features	Model number
Environment-resistive models Vacuum-resistant		210 130 35 110 85 35 65	1.2 dia. (0.01 dia.)	R30	L-shaped, heat-resistant up to 120°C	E32-T54V 1M
		660 500 180 420 320 180 390	4 dia. (0.1 dia.)		L-shaped, heat-resistant up to 120°C, long distance	E32-T54V 1M+ E36-F1V
		630 480 130 410 310 130 250	2 dia. (0.1 dia.)	R25	L-shaped, heat-resistant up to 200°C, long distance	T32-T84SV 1M

Flanges

Appearance (mm)	Type	Model number
	4-channel flange	E32-VF4
	1-channel flange	E32-VF1

Lens Units

Appearance (mm)	Type	Quantity	Remarks
	E39-F1V	2	Long-distance Lens Unit Can be used for the E32-51V and the E32-T54V.

Mounting Brackets

Appearance (mm)	Type	Quantity	Remarks
	E39-L54V	2	Can be used for the E32-T54V.

Fiber Units for Atmospheric-pressure Side

Appearance	Type	Model number
	Amplifier-Flange Connection Fiber	E32-T10V 2M

Fiber Units with Reflective Sensors

*1. The sensing distances are for white paper.







*2. The values for the minimum sensing object are representative values that indicate values obtained in standard mode with the sensing distance and sensitivity set to optimum values.

*3. **Free-cut** Indicates models that allow free cutting.

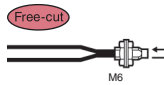
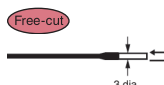
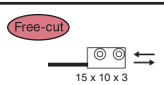
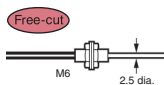
High-resolution mode **Standard mode** **Super-high-speed mode** When used in combination with the E3X-DA-S Amplifier Unit (general-purpose).

High-resolution mode **Standard mode** **Super-high-speed mode** When used in combination with the E3X-MDA Unit.

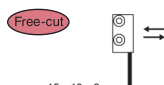
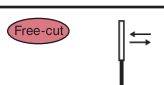
When used in combination with E3X-NA-F high speed unit. **When used in combination with E3X-NA or E3X-SD standard units.**

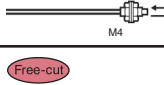
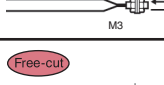
Type	Appearance (mm) *3	Sensing distance (mm) *1	Min. sensing object (mm) *2	Min. bending radius (mm)	Features	Model number	
Standard models Flexible (new standard)	Standard size		(0.005 dia.)	R R1	M6 screw	E32-D11R	
					300 170 50	3-dia. cylinder	E32-D12R
					300 170 50	Flat shape	E32-T15XR <i>NEW</i>
					90 30	M6 screw, with 90 mm sleeve	E32-DC200BR
						M6 screw, with 40 mm sleeve	E32-DC200B4R
					80 45 14 45 33 14 16 4	6-dia. cylinder, side-view	E32-D14LR
					70 40 12	Flat shape, side-view	E32-D15YR <i>NEW</i>
					40 29 12 20 5	Flat shape, flat-view	E32-D15ZR <i>NEW</i>
		Small size					M4 screw (small)
					50 30	M3 screw (small)	E32-D21R
					8 30 22	3-dia. cylinder (small)	E32-D22R
					8 15 5	Flat panel (small)	E32-D25XR <i>NEW</i>
						M3 screw (small), with 90 mm sleeve	E32-DC200FR
						M3 screw (small), with 40 mm sleeve	E32-DC200F4R <i>NEW</i>
						Min. bending radius of sleeve: 5	

R : Flexible fiber **B** : Bendable fiber **U** : Fluorine-coated fiber

Ordering Information

Fiber Units with Reflective Sensors

*1. The sensing distances are for white paper.

*2. The values for the minimum sensing object are representative values that indicate values obtained in standard mode with the sensing distance and sensitivity set to optimum values.

*3. **Free-cut** Indicates models that allow free cutting.

High-resolution mode **Standard mode** **Super-high-speed mode** When used in combination with the E3X-DA-S Amplifier Unit (general-purpose).

High-resolution mode **Standard mode** **Super-high-speed mode** When used in combination with the E3X-MDA Unit.

When used in combination with E3X-NA-F high speed unit. **When used in combination with E3X-NA or E3X-SD standard units.**

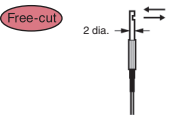
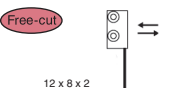
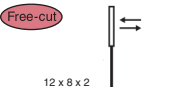
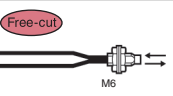
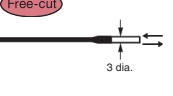
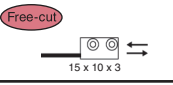
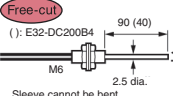
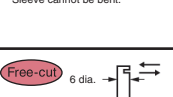
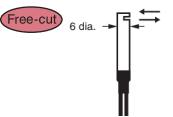
Type	Appearance (mm) *3	Sensing distance (mm) *1	Min. sensing object (mm) *2	Min. bending radius (mm)	Features	Model number
Flexible (new standard)	Small size	 Free-cut 2 dia.	26 15 4 15 10 4 7 2.3	(0.005 dia.)	R1	E32-D24R
		 Free-cut 12 x 8 x 2	14 8 2			E32-D25YR NEW
		 Free-cut 12 x 8 x 2	8 5 2 4 1.2			E32-D25ZR NEW
	Standard size	 Free-cut M6	500 300 90 300 210 90 150 5		R25	E32-DC200
		 Free-cut 3 dia.	400 230 70 230 160 70 120 40			E32-D12
		 Free-cut 15 x 10 x 3	500 300 90			E32-T15X NEW
Standard	 Free-cut (): E32-DC200B4 90 (40) M6 2.5 dia. Sleeve cannot be bent.	300 210 90 150 50	E32-DC200B			
	 Free-cut M6 40	300 210 90 150 50	E32-DC200B4			
	 Free-cut 6 dia.	200 110 36 110 80 36 40 13	E32-D14L			

R : Flexible fiber **B** : Bendable fiber **U** : Fluorine-coated fiber

Fiber Units with Reflective Sensors

*1. The sensing distances are for white paper.





*2. The values for the minimum sensing object are representative values that indicate values obtained in standard mode with the sensing distance and sensitivity set to optimum values.

*3. **Free-cut** Indicates models that allow free cutting.

High-resolution mode **Standard mode** **Super-high-speed mode** When used in combination with the E3X-DA-S Amplifier Unit (general-purpose).

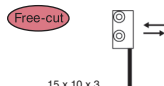
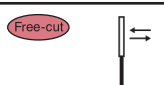
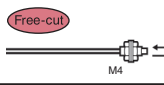
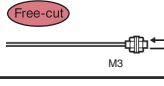
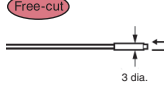
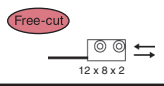
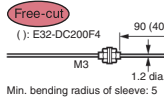
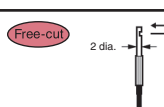
High-resolution mode **Standard mode** **Super-high-speed mode** When used in combination with the E3X-MDA Unit.

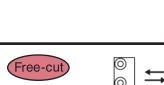
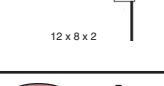
When used in combination with E3X-NA-F high speed unit. **When used in combination with E3X-NA or E3X-SD standard units.**

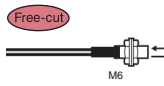
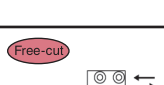
Type	Appearance (mm) *3	Sensing distance (mm) *1	Min. sensing object (mm) *2	Min. bending radius (mm)	Features	Model number
Standard models	Standard size	 Free-cut 15 x 10 x 3 170 100 30	(0.005 dia.)	R25	Flat shape, side-view	E32-D15Y NEW
		 Free-cut 15 x 10 x 3 100 70 30 50 15			Flat shape, flat-view	E32-D15Z NEW
		 Free-cut M4			M4 screw (small)	E32-D211 NEW
		 Free-cut M3			M3 screw (small)	E32-DC200E
		 Free-cut 3 dia.			3-dia. cylinder (small)	E32-D22 NEW
		 Free-cut 12 x 8 x 2			Flat shape (small)	E32-D25X NEW
	Small size	 Free-cut (): E32-DC200F4 M3 90 (40) 1.2 dia. Min. bending radius of sleeve: 5		130 80 22 80 55 22 36 12	M3 screw (small), with 90 mm sleeve	E32-DC200F
		 Free-cut 2 dia.		50 30 8 30 22 8 15 5	M3 screw (small), with 40 mm sleeve	E32-DC200F4
		 Free-cut 2 dia.		50 30 8 30 22 8 15 5	2-dia. cylinder (small), side-view	E32-D24
		 Free-cut 12 x 8 x 2		35 20 6 20	Flat shape (small), side-view	E32-D25Y NEW
		 Free-cut 12 x 8 x 2		14 6 10 3.3	Flat shape (small), flat-view	E32-D25Z NEW
		 Free-cut 12 x 8 x 2		14 6 10 3.3	Flat shape (small), flat-view	E32-D25Z NEW
Break-resistant	Standard size	 Free-cut M6	300 170 50	M6 screw	E32-D11	
		 Free-cut 15 x 10 x 3	170 125 50 90 30	Flat shape	E32-D15XB NEW	

R : Flexible fiber **B** : Bendable fiber **U** : Fluorine-coated fiber

Ordering Information

Fiber Units with Reflective Sensors

*1. The sensing distances are for white paper.

*2. The values for the minimum sensing object are representative values that indicate values obtained in standard mode with the sensing distance and sensitivity set to optimum values.

*3. **Free-cut** Indicates models that allow free cutting.

High-resolution mode **Standard mode** **Super-high-speed mode** When used in combination with the E3X-DA-S Amplifier Unit (general-purpose).

High-resolution mode **Standard mode** **Super-high-speed mode** When used in combination with the E3X-MDA Unit.

When used in combination with E3X-NA-F high speed unit. **When used in combination with E3X-NA or E3X-SD standard units.**

Type	Appearance (mm) *3	Sensing distance (mm) *1	Min. sensing object (mm) *2	Min. bending radius (mm)	Features	Model number			
Standard models	Break-resistant	Small size	(0.005 dia.)	<div style="display: flex; justify-content: center; align-items: center;"> <div style="border: 1px solid black; border-radius: 50%; padding: 2px 5px; margin-right: 5px;">B</div> <div style="margin-right: 5px;">R4</div> </div>	M4 screw (small)	E32-D21B			
						3-dia. cylinder (small)	E32-D221B NEW		
						M3 screw (small)	E32-D21		
						1.5-dia. cylinder (small)	E32-D22B		
						Flat shape (small)	E32-D25XB NEW		
	Area-sensing	Right angle			<div style="display: flex; justify-content: center; align-items: center;"> <div style="border: 1px solid black; border-radius: 50%; padding: 2px 5px; margin-right: 5px;">R</div> <div style="margin-right: 5px;">R1</div> </div>	M6 screw, right angle	E32-D11N NEW		
							M6 screw, right angle	E32-C11N NEW	
							M3 screw, right angle	E32-C31N NEW	
									<div style="display: flex; justify-content: center; align-items: center;"> <div style="border: 1px solid black; border-radius: 50%; padding: 2px 5px; margin-right: 5px;">B</div> <div style="margin-right: 5px;">R4</div> </div>

R : Flexible fiber **B** : Bendable fiber **U** : Fluorine-coated fiber

Fiber Units with Reflective Sensors

*1. The sensing distances are for white paper.

*2. The values for the minimum sensing object are representative values that indicate values obtained in standard mode with the sensing distance and sensitivity set to optimum values.

*3. **Free-cut** Indicates models that allow free cutting.

R High-resolution mode **B** Standard mode **U** Super-high-speed mode. When used in combination with the E3X-DA-S Amplifier Unit (general-purpose).

R High-resolution mode **B** Standard mode **U** Super-high-speed mode. When used in combination with the E3X-MDA Unit.

R When used in combination with E3X-NA-F high speed unit. **B** When used in combination with E3X-NA or E3X-SD standard units.

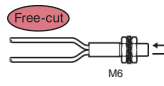
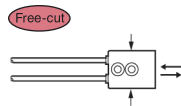
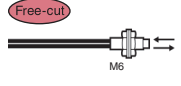
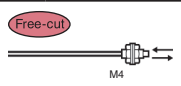
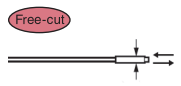
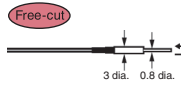
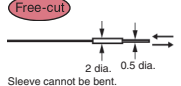
Type	Appearance (mm) *3	Sensing distance (mm) *1	Min. sensing object (mm) *2	Min. bending radius (mm)	Features	Model number	
Standard models	Chemical resistance	 R 300 B 170 R 50 U 170 U 125 U 50 R 90 R 30	(0.005 dia.)	U R4	M6 screw, fluorine coating	E32-D11U	
Special-beam models	Long-distance, high-power	 R 40 to 1,000 R 40 to 700 B 40 to 240 U 40 to 600 U 40 to 490 U 40 to 240 R 40 to 400 R 55 to 70	—	B R4	Large built-in lens, screw mounting	E32-D16	
		 R 650 R 400 R 110 U 400 U 270 U 110 R 200 R 65		R25	M6 screw	E32-D11L	
	Long-distance, high-power	 R 210 R 130 R 30 U 130		(0.005 dia.)	R10	M4 screw	E32-D21L
		 U 85 U 35 R 50 R 17				3-dia. cylinder	E32-D22L
		 R 25 R 16 R 4 U 16 U 10 R 4 R 10 R 3.3	Sleeve cannot be bent.				0.8-dia. sleeve
	Ultracompact, thin sleeve	 R 5 R 3 R 0.8 U 3 U 2 U 0.8 R 1.5 R 0.5	Sleeve cannot be bent.		B R4	0.5-dia. sleeve	E32-D331

R : Flexible fiber **B** : Bendable fiber **U** : Fluorine-coated fiber

Ordering Information

Fiber Units with Reflective Sensors

*1. The sensing distances are for white paper.







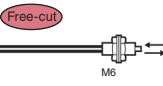
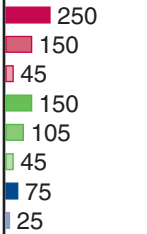

*2. The values for the minimum sensing object are representative values that indicate values obtained in standard mode with the sensing distance and sensitivity set to optimum values.

*3. **Free-cut** Indicates models that allow free cutting.

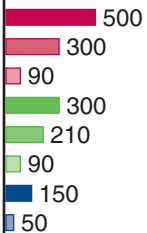
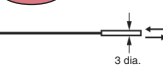
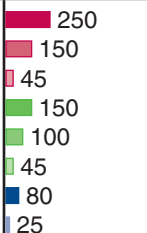
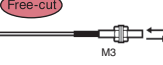
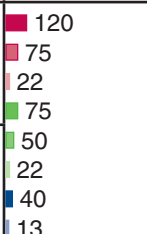
High-resolution mode **Standard mode** **Super-high-speed mode** When used in combination with the E3X-DA-S Amplifier Unit (general-purpose).

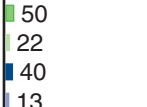
High-resolution mode **Standard mode** **Super-high-speed mode** When used in combination with the E3X-MDA Unit.

When used in combination with E3X-NA-F high speed unit. **When used in combination with E3X-NA or E3X-SD standard units.**

Type	Appearance (mm) *3	Sensing distance (mm) *1	Min. sensing object (mm) *2	Min. bending radius (mm)	Features	Model number
Special-beam models	Coaxial, small-spot	 	(0.005 dia.)	 R4	M6 screw	E32-CC200R NEW
		 				E32-CC200
		 				E32-D32L
		 				E32-C31
		 				E32-D32
		 6 to 15 mm; spot diameter: 0.1 to 0.6 mm Spot diameter of Free-cut 0.5 to 1 mm at distances in the range 6 to 15 mm				E32-C42+ E39-F3A
		 Spot diameter of 0.1 mm at 7 mm Spot diameter of Free-cut 0.5 mm at 7 mm				E32-C41+ E39-F3A-5
		 Spot diameter of 0.2 mm at 17 mm Spot diameter of Free-cut 0.5 mm at 17 mm				E32-C41+ E39-F3B
						E32-C31+ E39-F3B

 : Flexible fiber  : Bendable fiber  : Fluorine-coated fiber

Fiber Units with Reflective Sensors

*1. The sensing distances are for white paper.

*2. The values for the minimum sensing object are representative values that indicate values obtained in standard mode with the sensing distance and sensitivity set to optimum values.

*3. **Free-cut** Indicates models that allow free cutting.

R High-resolution mode **B** Standard mode **U** Super-high-speed mode. When used in combination with the E3X-DA-S Amplifier Unit (general-purpose).

R High-resolution mode **B** Standard mode **U** Super-high-speed mode. When used in combination with the E3X-MDA Unit.

R When used in combination with E3X-NA-F high speed unit. **B** When used in combination with E3X-NA or E3X-SD standard units.

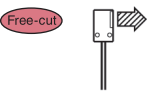
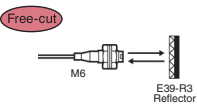
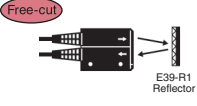
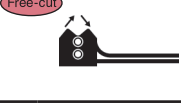
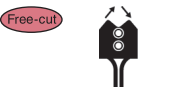
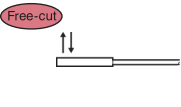
Type	Appearance (mm) *3	Sensing distance (mm) *1	Min. sensing object (mm) *2	Min. bending radius (mm)	Features	Model number																	
Special-beam models	Coaxial, small-spot	 4-dia. spot	Spot diameter of 4 mm max. at distances in the range 0 to 20 mm	(0.005 dia.)	R25	Long-distance sensing, parallel light	E32-C31+ E39-F3C																
	Area-sensing		<table border="1"> <tr><td>R</td><td>250</td></tr> <tr><td>B</td><td>150</td></tr> <tr><td>U</td><td>45</td></tr> <tr><td>R</td><td>150</td></tr> <tr><td>B</td><td>100</td></tr> <tr><td>U</td><td>45</td></tr> <tr><td>R</td><td>75</td></tr> <tr><td>B</td><td>25</td></tr> </table>	R	250	B	150	U	45	R	150	B	100	U	45	R	75	B	25	(0.005 dia.)	B R4	Beam width: 11 mm	E32-D36P1
	R	250																					
	B	150																					
	U	45																					
R	150																						
B	100																						
U	45																						
R	75																						
B	25																						
Retroreflective		<table border="1"> <tr><td>R</td><td>10 to 250</td></tr> <tr><td>B</td><td>10 to 250</td></tr> <tr><td>U</td><td>10 to 250</td></tr> <tr><td>R</td><td>10 to 250</td></tr> <tr><td>B</td><td>10 to 250</td></tr> <tr><td>U</td><td>10 to 250</td></tr> <tr><td>R</td><td>10 to 250</td></tr> <tr><td>B</td><td>10 to 250</td></tr> </table>	R	10 to 250	B	10 to 250	U	10 to 250	R	10 to 250	B	10 to 250	U	10 to 250	R	10 to 250	B	10 to 250	(0.1 dia.)	R10	M6 screw	E32-R21+ E39-R3 (Reflector supplied.)	
R	10 to 250																						
B	10 to 250																						
U	10 to 250																						
R	10 to 250																						
B	10 to 250																						
U	10 to 250																						
R	10 to 250																						
B	10 to 250																						
Retroreflective		<table border="1"> <tr><td>R</td><td>150 to 1,500</td></tr> <tr><td>B</td><td>150 to 1,500</td></tr> <tr><td>U</td><td>150 to 1,500</td></tr> <tr><td>R</td><td>150 to 1,500</td></tr> <tr><td>B</td><td>150 to 1,500</td></tr> <tr><td>U</td><td>150 to 1,500</td></tr> <tr><td>R</td><td>150 to 1,500</td></tr> <tr><td>B</td><td>150 to 1,500</td></tr> </table>	R	150 to 1,500	B	150 to 1,500	U	150 to 1,500	R	150 to 1,500	B	150 to 1,500	U	150 to 1,500	R	150 to 1,500	B	150 to 1,500	(0.2 dia.)	R25	Screw mounting, long distance	E32-R16+ E39-R1 (Reflector supplied.)	
R	150 to 1,500																						
B	150 to 1,500																						
U	150 to 1,500																						
R	150 to 1,500																						
B	150 to 1,500																						
U	150 to 1,500																						
R	150 to 1,500																						
B	150 to 1,500																						
Limited-reflective		3.3	(0.005 dia.)	R25	Small level differences, high power, side-view	E32-L25																	
		3.3			Small level differences, high power, top-view	E32-L25A																	
		0 to 4			R10	Ultracompact, flat-view	E32-L24S																

R : Flexible fiber **B** : Bendable fiber **U** : Fluorine-coated fiber



Ordering Information

Fiber Units with Reflective Sensors

*1. The sensing distances are for white paper.















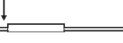

*2. The values for the minimum sensing object are representative values that indicate values obtained in standard mode with the sensing distance and sensitivity set to optimum values.

*3. **Free-cut** Indicates models that allow free cutting.

 High-resolution mode  Standard mode  Super-high-speed mode. When used in combination with the E3X-DA-S Amplifier Unit (general-purpose).



 High-resolution mode  Standard mode  Super-high-speed mode. When used in combination with the E3X-MDA Unit.

 When used in combination with E3X-NA-F high speed unit.  When used in combination with E3X-NA or E3X-SD standard units.

Type	Appearance (mm) *3	Sensing distance (mm) *1	Min. sensing object (mm) *2	Min. bending radius (mm)	Features	Model number
Special-beam models Limited-reflective	 	2 to 6 (center: 4) 2 to 6 (center: 4) 2 to 6 (center: 4) 2 to 6 (center: 4) 2 to 6 (center: 4) 2 to 6 (center: 4) 2 to 6 (center: 4)	(0.005 dia.)	R10	Heat resistant up to 105°C *4, top-view	E32-L24L
	 	5.4 to 9 (center: 7.2) 5.4 to 9 (center: 7.2) 5.4 to 9 (center: 7.2) 5.4 to 9 (center: 7.2) 5.4 to 9 (center: 7.2) 5.4 to 9 (center: 7.2) 5.4 to 9 (center: 7.2)			Heat resistant up to 105°C *4, top-view	E32-L25L
		4 to 10 4 to 10 4 to 10 4 to 10 4 to 10 4 to 10 4 to 10		R25	Heat resistant up to 200°C, flat-view	E32-L86 NEW
	 	0 to 15 0 to 15 0 to 12 0 to 15 0 to 15 0 to 12 0 to 15 0 to 13			Wide-range sensing, flat-view	E32-L16
Environment-resistant models Heat-resistant	150°C  	 400  230  72  230  165  72  120  40	(0.005 dia.)	R35	Heat resistant up to 150°C	E32-D51

*4. For continuous operation, use the products within a temperature range of -40°C to 90°C.

*5. For continuous operation, use the products within a temperature range of -40°C to 130°C.

 : Flexible fiber  : Bendable fiber  : Fluorine-coated fiber

Fiber Units with Reflective Sensors

*1. The sensing distances are for white paper.

*2. The values for the minimum sensing object are representative values that indicate values obtained in standard mode with the sensing distance and sensitivity set to optimum values.

*3. **Free-cut** Indicates models that allow free cutting.

High-resolution mode **Standard mode** **Super-high-speed mode** When used in combination with the E3X-DA-S Amplifier Unit (general-purpose).

High-resolution mode **Standard mode** **Super-high-speed mode** When used in combination with the E3X-MDA Unit.

When used in combination with E3X-NA-F high speed unit. **When used in combination with E3X-NA or E3X-SD standard units.**

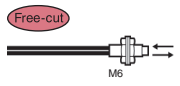
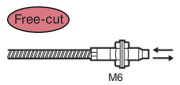
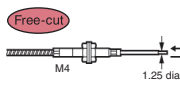
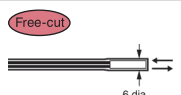
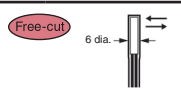
Type	Appearance (mm) *3	Sensing distance (mm) *1	Min. sensing object (mm) *2	Min. bending radius (mm)	Features	Model number	
Environment-resistant models	Heat-resistant	200°C  Free-cut	<ul style="list-style-type: none"> ■ 150 ■ 90 ■ 27 ■ 90 	(0.005 dia.)	R10	Heat resistant up to 200°C *4 E32-D81R-S E32-D81R	
		350°C  Free-cut	<ul style="list-style-type: none"> ■ 63 ■ 27 ■ 45 ■ 15 		R25	Heat resistant up to 350°C *4 E32-D61-S E32-D61	
		400°C  Free-cut Min. bending radius of sleeve: 10	<ul style="list-style-type: none"> ■ 100 ■ 60 ■ 18 ■ 60 ■ 40 ■ 18 ■ 30 ■ 10 		R25	Heat resistant up to 400°C *4, with sleeve E32-D73-S E32-D73	
	Chemical-resistant	 Free-cut	<ul style="list-style-type: none"> ■ 160 ■ 95 ■ 30 ■ 95 ■ 70 ■ 30 ■ 50 ■ 16 	(0.005 dia.)	U R40	Fluororesin cover, long distance	E32-D12F
		 Free-cut	<ul style="list-style-type: none"> ■ 70 ■ 40 ■ 10 ■ 40 ■ 28 ■ 10 ■ 20 ■ 6.5 			Fluororesin cover, side-view	E32-D14F NEW

*4. The maximum temperature that can be withstood varies with the location. Refer to dimensions diagrams for details.

R: Flexible fiber **B**: Bendable fiber **U**: Fluorine-coated fiber

Ordering Information

Application-specific Fiber Units







*1. The values for the minimum sensing object are representative values that indicate values obtained in standard mode with the sensing distance and sensitivity set to optimum values.

*2. **Free-cut** Indicates models that allow free cutting.

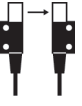
High-resolution mode **Standard mode** **Super-high-speed mode**. When used in combination with the E3X-DA-S Amplifier Unit (general-purpose).

High-resolution mode **Standard mode** **Super-high-speed mode**. When used in combination with the E3X-MDA Unit.

When used in combination with E3X-NA-F high speed unit. **When used in combination with E3X-NA or E3X-SD standard units.**

Type	Appearance (mm) *2	Sensing distance (mm)	Standard object (min. sensing object) (mm) *1	Min. bending radius (mm)	Features	Model number
Label-dection	Free-cut 	10 10 10 10 10 10 10 10	4 dia. (0.1 dia.)	R25	Slot sensor (no adjustment of optical axis required)	E32-G14
	Free-cut 	High-resolution mode 4,500 Standard mode 3,400 Super-high-speed mode 900 High-resolution mode 2,900 Standard mode 2,200 Super-high-speed mode 900 When used in combination with E3X-NA-F high speed unit. 1,800 When used in combination with E3X-NA or E3X-SD standard units. 540			Screw mounting, side-view	E32-T14
Application-specific models	Free-cut 	Applicable tube: Transparent tube with a diameter in the range 8 to 10 mm and a recommended wall thickness of 1 mm		R10	Compact	E32-L25T
	Free-cut 	Applicable tube: Transparent tube (no restriction on diameter)		B R4	No restriction on tube diameter, resistant to bubbles and drops of water	E32-D36T NEW
	Free-cut 	Applicable tube: Transparent tube with a diameter of 3.2, 6.4, or 9.5 mm and a recommended wall thickness of 1 mm			Light ON when fluid is present, resistant to bubbles and drops of water	E32-A01
	Free-cut 	Applicable tube: Transparent tube with a diameter in the range 6 to 13 mm and a recommended wall thickness of 1 mm			Light ON when fluid is not present, resistant to bubbles and drops of water	E32-A02
		Liquid-contact models		R40	Heat resistant up to 200°C, fluororesin cover	E32-D82F1 E32-D82F2

R : Flexible fiber **B** : Bendable fiber **U** : Fluorine-coated fiber

Application-specific Fiber Units

*1. The values for the minimum sensing object are representative values that indicate values obtained in standard mode with the sensing distance and sensitivity set to optimum values.

*2. **Free-cut** Indicates models that allow free cutting.

High-resolution mode Standard mode Super-high-speed mode. When used in combination with the E3X-DA-S Amplifier Unit (general-purpose).

High-resolution mode Standard mode Super-high-speed mode. When used in combination with the E3X-MDA Unit.

When used in combination with E3X-NA-F high speed unit. When used in combination with E3X-NA or E3X-SD standard units.

Type	Appearance (mm) *2	Sensing distance (mm)	Standard object (min. sensing object) (mm) *1	Min. bending radius (mm)	Features	Model number	
Application-specific models	Glass-substrate-alignment	 0 to 15 0 to 15 0 to 12 0 to 15 0 to 15 0 to 12 0 to 15 0 to 13	Soda glass with reflection factor of 7%	R25	Variation of detection position within the detection range: 0.2 mm	E32-L16	
		10 to 20 10 to 20				E32-A08 NEW	
		15 to 25 15 to 25				E32-A07E1 E32-A07E2 NEW	
	Glass-substrate-mapping	 5 to 18 5 to 18 5 to 18		Edge of soda glass with reflection factor of 7% (t = 0.5 mm, rounded edge)	R25	Heat resistant up to 300°C *4, *5	E32-L66
		 15 to 38 (center: 25) 15 to 38 (center: 25)			R25	Resistant to tilting	E32-A09 NEW
		 20 to 30 (center: 25) 20 to 30 (center: 25)			R35	Heat resistant up to 150°C *3	E32-A09H NEW
Application-specific models	Water-mapping	 1,150 890 250	2 dia. (0.1 dia.)	R1	Opening angle: 1.5°; optical axis adjusted before delivery	E32-A03	
		 1,750 1,300 350		R10	Opening angle: 1.5°; with mounting flange; optical axis adjusted before delivery	E32-A03-1 NEW	
					Long distance; opening angle: 6°	E32-T24S	

*3. For continuous operation, use the products within a temperature range of -40°C to 130°C.

*4. The maximum temperature that can be withstood varies with the location. Refer to dimensions diagrams for details.

*5. These values are based on the assumption that there are no repeated sudden changes in temperature.



: Flexible fiber : Bendable fiber : Fluorine-coated fiber

Ordering Information

Application-specific Fiber Units



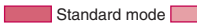



*1. The values for the minimum sensing object are representative values that indicate values obtained in standard mode with the sensing distance and sensitivity set to optimum values.

*2.  Indicates models that allow free cutting.

 High-resolution mode  Standard mode  Super-high-speed mode. When used in combination with the E3X-DA-S Amplifier Unit (general-purpose).

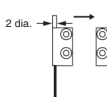
 High-resolution mode  Standard mode  Super-high-speed mode. When used in combination with the E3X-MDA Unit.

 When used in combination with E3X-NA-F high speed unit.  When used in combination with E3X-NA or E3X-SD standard units.

Type	Appearance (mm) *2	Sensing distance (mm)	Standard object (min. sensing object) (mm) *1	Min. bending radius (mm)	Features	Model number
Application-specific models	Water-mapping	 	1.2 dia. (0.1 dia.)	R10	Ultra-slim (t = 2 mm); opening angle: 3°; optical axis adjusted before delivery	E32-A04
		 			 460  340  100	Ultra-slim (t = 2 mm); opening angle: 3°; with mounting flange; optical axis adjusted before delivery

Through-beam Fiber Units used with E3X-DAC True Color Amplifier

Type	Applicable Fiber Units	Sensing distance (mm) with opaque object			Sensing distance (mm) with translucent object*				
		High resolution mode	Standard mode	Super high-speed mode	High resolution mode	Standard mode	Super high-speed mode		
Standard models	General purpose	E32-TC200	200	160	70	45	32	22	
		E32-T11R/ E32-T12R/ E32-T15XR/ E32-TC200BR/ E32-TC200 B4R	150	110	50	30	22	16	
		E32-T14LR/ E32-T15YR/ E32-T15ZR	55	4	19	12	8.5	6.5	
		E32-TC200E/ E32-T22/ E32-T222/ E32-T25X/ E32-TC200F/ E32-TC200F4	80	60	46	17	12	7	
		E32-T24/ E32-T25Y/ E32-T25Z	48	36	26	10	7	4	
	Break-resistant	E32-T11/ E32-T12B/ E32-T15XB	190	140	60	40	28	20	
		E32-T21/ E32-T221B/ E32-T22B	70	55	40	15	11	6	
		E32-T25XB	55	42	30	11	8	4.5	
	Fluorine coating	E32-T11U	190	140	60	40	28	20	
	Special-beam models	Long-distance, high-power	E32-T17L	4,300	3,200	1,400	900	600	460
			E32-TC200+ E39-F1	1,100	850	360	220	160	120
			E32-T11R+ E39-F1	1,000	750	340	220	150	110
			E32-T11+ E39-F1	1,000	750	320	200	150	110
E32-T14			950	700	300	200	140	100	
E32-T11L/ E32-T12L			350	250	120	75	55	40	
E32-T11L+ E39-F2			220	160	75	46	32	25	
E32-T11R+ E39-F2			110	85	36	22	16	12	
E32-T11+ E39-F2			180	140	60	38	28	20	
E32-T12L/ E32-T22L			160	120	90	34	24	14	

*Note: These sensing distances are recommended to make the most of the detection capabilities of the Sensor.

Through-beam Fiber Units used with E3X-DAC True Color Amplifier

Type	Applicable Fiber Units	Sensing distance (mm) with opaque object			Sensing distance (mm) with translucent object*			
		High resolution mode	Standard mode	Super high-speed mode	High resolution mode	Standard mode	Super high-speed mode	
Special-beam models	Fine beam	E32-T22S	500	400	170	110	80	55
		E32-T24S	360	280	120	75	55	40
	Area-sensing	E32-T16	750	600	250	160	110	85
		E32-T16PR	240	180	80	50	36	26
		E32-T16JR	200	160	65	44	30	22
		E32-T16WR	360	280	120	75	55	40
	Label detection (Slot Sensor)	E32-G14	10			10		
Environment-resistive models	Heat-resistant	E32-T51	200	160	70	44	32	22
		E32-T54	60	48	20	13	9.5	7
		E32-T81R-S	75	60	26	16	11	8.5
		E32-T61-S	120	95	42	26	19	14
		E32-T61-S + E39-F1	950	700	320	200	140	100
		E32-T61-S + E39-F2	120	95	42	26	19	14
		E32-T84S-S	360	280	120	75	55	40
	Chemical-resistant	E32-T11F	550	420	180	110	80	60
		E32-T12F	850	650	280	180	120	95
		E32-T14F	100	80	35	22	16	12
		E32-T51F	380	300	130	80	55	44
		E32-T81F-S	190	150	65	40	28	22
	Vacuum-resistant	E32-T51V	55	42	18	11	805	6
		E32-T51V + E39-F1V	280	200	90	55	42	30
		E32-T54V	36	28	12	705	5.5	4
		E32-T54V + E39-F1V	140	100	46	28	20	15
		E32-T84SV	130	100	45	28	20	15

*Note: These sensing distances are recommended to make the most of the detection capabilities of the Sensor.

Fiber Units with Reflective Sensors used with E3X-DAC True Color Detection

Type	Applicable Fiber Units	Sensing distance (mm) with white paper			Sensing distance (mm) with standard color card (11 colors) mutual determination				
		High resolution mode	Standard mode	Super high-speed mode	High resolution mode	Standard mode	Super high-speed mode		
Standard models	General purpose	E32-DC200	70	54	18	14	10	6	
		E32-D11R/ E32-D12R/ E32-D15XR/ E32-DC200BR/ E32-DC200B4R	42	32	11	8.5	6	3.5	
		E32-D14LR/	11	8.5	2.5	2.4	1.7	1	
		E32-D15YR/ E32-D15ZR	10	7.5	2.5	2.1	1.5	0.9	
		E32-D211/ E32-DC200E/ E32-D22/ E32-D25X/ E32-DC200F/ E32-DC200F4	20	16	5	4.5	3	1.5	
		E32-D24/	8.8	6.7	2.1	1.8	1.3	0.7	
		E32-D25Y/ E32-D25Z	5.8	4.5	1.4	1.2	0.9	0.5	
	Break-resistant	E32-D11/ E32-D15XB	42	32	11	8.5	6	3.5	
		E32-D21B/ E32-D221B	19	15	4.5	4.1	3	1.5	
		E32-D21/ E32-D22B	8.8	6.7	2.1	1.8	1.3	0.7	
		E32-D25XB	14	10	3	3	2.1	1.1	
	Fluorine coating	E32-D11U	42	32	11	8.5	6	3.5	
	Special-beam models	Long-distance, high-power	E32-A09	20 to 38	24 to 36	—	20 to 38	24 to 36	—
			E32-D11L	90	70	22	19	13	7.5
E32-D21L/ E32-D22L			35	26	8	7	5	2.5	
Coaxial		E32-CC200	60	45	16	12	9	4	
		E32-CC200R	35	26	9	7.5	5	3	
		E32-D32L	35	26	9	7.5	5	3	
		E32-C31/ E32-D32	17	13	4.5	3.7	2.7	1.5	
Area-sensing		E32-D36P1	35	26	9	7.5	5	3	

Ordering Information

Fiber Units with Reflective Sensors used with E3X-DAC True Color Detection

Type	Applicable Fiber Units	Sensing distance (mm) with white paper			Sensing distance (mm) with standard color card (11 colors) mutual determination			
		High resolution mode	Standard mode	Super high-speed mode	High resolution mode	Standard mode	Super high-speed mode	
Environment-resistive models	Heat-resistant	E32-D51	55	42	14	11	8.5	4.5
		E32-D81R-S/ E32-D61-S	20	15	5	4	3	1.5
		E32-D73-S	13	10	3.5	2.8	2	1.2
	Chemical-resistant	E32-D12F	22	17	6	4.9	3.5	2
		E32-D14F	9	7	2	2.1	1.4	0.6

Accessories

*1. The values for the minimum sensing object are representative values that indicate values obtained in standard mode with the sensing distance and sensitivity set to optimum values.

High-resolution mode Standard mode Super-high-speed mode When used in combination with the E3X-DA-S Amplifier Unit (general-purpose).

High-resolution mode Standard mode Super-high-speed mode When used in combination with the E3X-MDA Unit.

When used in combination with E3X-NA-F high speed unit. When used in combination with E3X-NA or E3X-SD standard units.

Lens Units

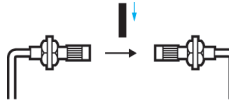
Type	Appearance	Applicable Fiber Units	Sensing distance (mm)	Standard object (min. sensing object) (mm) *1	Features	Lens model number
Through-beam Lens Units Long-distance Lens Units		E32-T11L	<ul style="list-style-type: none"> 4,000*2 3,200 840 1,100 870 350 700 210 	4 dia. (0.1 dia.)	Long-distance sensing; opening angle: 5° to 40° (heat resistant up to 200°C)	E39-F1
		E32-TC200	<ul style="list-style-type: none"> 4,000*2 4,000*2 1,500 4,000*2 3,700 1,500 3,000 900 			
		E32-T11R	<ul style="list-style-type: none"> 4,000*2 3,700 970 3,100 2,400 970 2,100 630 			
		E32-T11	<ul style="list-style-type: none"> 4,000*2 3,600 930 3,000 2,300 930 2,000 600 			
		E32-T11N	<ul style="list-style-type: none"> 4,000*2 3,700 970 3,100 2,400 970 2,100 630 			
		E32-T11U	<ul style="list-style-type: none"> 4,000*2 3,600 930 3,000 2,300 930 2,000 600 			

*2. The optical fiber is 2 m long on each side to permit a total sensing distance of 4,000 mm.

Ordering Information

Accessories

*1. The values for the minimum sensing object are representative values that indicate values obtained in standard mode with the sensing distance and sensitivity set to optimum values.

High-resolution mode Standard mode Super-high-speed mode When used in combination with the E3X-DA-S Amplifier Unit (general-purpose).

High-resolution mode Standard mode Super-high-speed mode When used in combination with the E3X-MDA Unit.

When used in combination with E3X-NA-F high speed unit. When used in combination with E3X-NA or E3X-SD standard units.

Type	Appearance	Applicable Fiber Units	Sensing distance (mm)	Standard object (min. sensing object) (mm) *1	Features	Lens model number
Long-distance Lens Units		E32-T81R-S	<ul style="list-style-type: none"> 2,650 2,100 520 1,600 1,300 520 1,050 380 	4 dia. (0.1 dia.)	Long-distance sensing; opening angle: 5° to 40° (heat resistant up to 200°C)	E39-F1
		E32-T61-S	<ul style="list-style-type: none"> 4,000*2 3,400 900 3,000 2,200 900 3,000 900 			
Through-beam Lens Units		E32-T11L	<ul style="list-style-type: none"> 910 800 180 600 520 180 500 150 	3 dia. (0.1 dia.)	Side-view, space-saving; opening angle: 20° to 60° (heat resistant up to 200°C)	E39-F2
		E32-TC200	<ul style="list-style-type: none"> 840 700 160 470 360 140 300 90 			
		E32-T11R	<ul style="list-style-type: none"> 520 400 100 330 260 100 220 65 			
		E32-T11	<ul style="list-style-type: none"> 820 660 160 530 430 160 360 100 			

*2. The optical fiber is 2 m long on each side to permit a total sensing distance of 4,000 mm.

Accessories

*1. Sensing distance when operated with E3X-DA-S amplifier





*2. Sensing distance when operated with E3X-MDA amplifier

*3. The values for the minimum sensing object are representative values that indicate values obtained in standard mode with the sensing distance and sensitivity set to optimum values.

High-resolution mode Standard mode Super-high-speed mode *When used in combination with the E3X-DA-S Amplifier Unit (general-purpose).

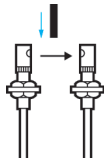
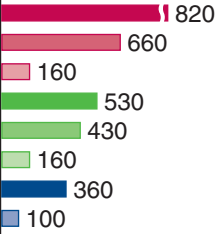
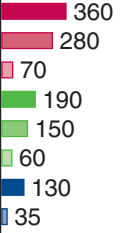
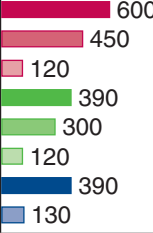
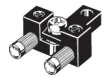
High-resolution mode Standard mode Super-high-speed mode *When used in combination with the E3X-MDA Unit.





*When used in combination with E3X-NA-F high speed unit. *When used in combination with E3X-NA or E3X-SD standard units.

Type	Appearance	Applicable Fiber Units	Sensing distance (mm) *1	Standard object (min. sensing object) (mm) *3	Features	Lens model number
Through-beam Lens Units		E32-T11U	 820 660 160 530 430 160 360 100	3 dia. (0.1 dia.)	Side-view, space-saving opening angle: 20° to 60° (heat resistant up to 200°C)	E39-F2
		E32-T81R-S	 360 280 70 190 150 60 130 35			
		E32-T61-S	 600 450 120 390 300 120 390 130			
Through-beam Lens Units		E32-T11L E32-TC200 E32-T11R E32-T11 E32-T11U E32-T81R-S E32-T61-S	—	—	Long distance reflection (heat resistant up to 200°C)	E39-F3
Small-spot Lens Units		E32-C42	Spot diameter variable in the range 0.1 to 0.6 mm at distances in the range 6 to 15 mm	Small spot (variable)	E39-F3A	
		E32-D32	Spot diameter variable in the range 0.5 to 1 mm at distances in the range 6 to 15 mm			
		E32-C41	0.1-dia. spot at a distance of 7 mm	Small spot	E39-F3A-5	
		E32-C31	0.5-dia. spot at a distance of 7 mm			
		E32-C41	0.2-dia. spot at a distance of 17 mm	Long distance, Small spot	E39-F3B	
		E32-C31	0.5-dia. spot at a distance of 17 mm			
	E32-C31 E32-C41	Spot diameter of 4 mm max. at distances in the range 0 to 20 mm	Long-distance sensing, parallel light	E39-F3C		

Ordering Information





Accessories

Protective Spiral Tube

Appearance	Application	Applicable Fiber Units	Tube length	Model number
	Fiber protection	M3-screw models E32-D21□ E32-DC200E E32-DC200F□ E32-C31	500 mm	E39-F32A5
			1 m	E39-F32A
		M3-screw models E32-T21□ (Except the E32-T21R.) E32-TC200E E32-TC200F□	500 mm	E39-F32B5
			1 m	E39-F32B
		M4-screw models E32-T11□ E32-TC200 E32-TC200B□ E32-T51	500 mm	E39-F32C5
			1 m	E39-F32C
		M6-screw models E32-D11□ E32-DC200 E32-DC200B E32-CC200□ E32-D51	500 mm	E39-F32D5
			1 m	E39-F32D

Note: Before using a Protective Spiral Tube, remove the protective tube that protects the area between the head and the optical fiber provided with some models.

Other Accessories

Appearance	Application	Name	Applicable Fiber Units	Remarks	Model number
	Used to cut the fiber.	Cutter	Fiber Units that allow free cutting	Provided with applicable Fiber Units.	E39-F4
	Attachments for inserting thin fibers into Amplifier Units	Thin-fiber Attachments	Fiber Units that allow free cutting and have a 1.0-dia. sheath	<ul style="list-style-type: none"> • 2 per set • Provided with applicable Fiber Units. 	E39-F9
	Used to extend fibers.	Fiber Connectors	Fiber Units that allow free cutting and have a 2.2-dia. sheath	—	E32-F10
	Easy-to-use, one-touch relay connectors		Fiber Units that allow free cutting	E39-F13: Used for Fiber Units with a 2.2-dia. sheath. E39-F14: Used for Fiber Units with a 1.0-dia. sheath. E39-F15: Used for Fiber Units with a sheath diameter between 1.0 and 2.2 mm.	E39-F13 E39-F14 E39-F15
	Used to bends in sleeves.		Sleeve Bender	E32-TC200B(4) E32-TC200F(4) E32-DC200F(4)	—

Ratings/Characteristics

Fiber Units

Type	Standard models				
	Flexible		Standard	Break-resistant	Fluorine-coating
Item	E32-T1□R E32-D1□R E32-T11N E32-D11N E32-C11N E32-C31N	E32-T2□R E32-D2□R			
Ambient operating temperature *1	-40°C to 70°C				
Ambient humidity *1	35% to 85%				
Fiber material	Plastic (PVC coating)	Plastic (polyethylene coating)		Plastic (PVC coating)	Plastic (fluororesin coating)
Degree of protection	IEC standard: IP67				

Type	Special-beam models				
	Long-distance, high power		Ultracompact, ultrafine-sleeve	Coaxial, small-spot	Fine-beam (narrow vision field)
Item	All other models	E32-D16			
Ambient operating temperature *1	-40°C to 70°C				
Ambient humidity *1	35% to 85%				
Fiber material	Plastic (polyethylene coating)	Plastic (PVC coating)	Plastic (combination of PVC, polyethylene, and polyolefin sheaths)		Plastic (PVC coating)
Degree of protection	IEC standard: IP67	IEC standard: IP40	IEC standard: IP67		

Type	Special-beam models				
	Area-sensing			Retroreflective	
Item	All other models	E32-D36P1 E32-T16 E32-ET16WR-1 E32-ET16WR-2	E32-T16W(R)	E32-R21	E32-R16
Ambient operating temperature *1	-40°C to 70°C		-25°C to 55°C	-40°C to 70°C	-25°C to 55°C
Ambient humidity *1	35% to 85%				
Fiber material	Plastic (PVC coating)	Plastic (polyethylene coating)	Plastic (PVC coating)	Plastic (polyethylene coating)	
Degree of protection	IEC standard: IP50 (IP67 for E32-T16)			IEC standard: IP67	IEC standard: IP66

Type	Special-beam models		
	Limited-reflective		
Item	All other models	E32-L25L E32-L24L	E32-L86
Ambient operating temperature *1	-40°C to 70°C	-40°C to 105°C *2	-40°C to 200°C *3
Ambient humidity *1	35% to 85%		
Fiber material	Plastic (polyethylene coating)		Glass (SUS spiral coating)
Degree of protection	IEC standard: IP50 (IP40 for E32-L24S, E32-L16, and E32-L86)		

*1. There must be no icing or condensation within the range specified for the ambient operating temperature.

*2. For continuous operation, use the products within a temperature range of -40°C to 90°C.

*3. The maximum temperature that can be withstood varies with the location. Refer to dimensions diagrams for details.

Ratings/Characteristics

Fiber Units

Item	Type	Environment-resistive models				
	Heat-resistant					
	E32-T5□ E32-D5□	E32-T8□R-S E32-D8□R-S	E32-T84S-S	E32-T6□-S E32-D6□-S	E32-D73-S	
Ambient operating temperature *1	-40°C to 150°C *4		-40°C to 200°C *3		-60°C to 350°C *3	-40°C to 400°C *3
Ambient humidity *1	35% to 85%					
Fiber material	Plastic (fluororesin coating)		Glass (fluororesin coating)	Glass (SUS spiral coating)		
Degree of protection	IEC standard: IP67					

Item	Type	Environment-resistive models				
	Chemical-resistant			Vacuum-resistant		
	All other models	E32-T51F	E32-T81F-S	All other models	32-T84SV	
Ambient operating temperature *1	-40°C to 70°C		-40°C to 150°C *4	-40°C to 200°C *3	-25°C to 120°C	-25°C to 200°C
Ambient humidity *1	35% to 85%					
Fiber material	Plastic (fluororesin coating)			Glass (fluororesin cover)	Glass (fluororesin coating)	Glass (SUS spiral coating)
Degree of protection	IEC standard: IP67			—		

Item	Type	Application-specific models				
	Label-detection	Liquid-level detection			Wafer-mapping	
		All other models	E32-A01 E32-A02	E32-D82F		
Ambient operating temperature *1	-40°C to 70°C			-40°C to 200°C *3	-40°C to 70°C	
Ambient humidity *1	35% to 85%					
Fiber material	Plastic (polyethylene coating)		Plastic (fluororesin coating)	Fluororesin cover	Plastic (polyethylene coating)	
Degree of protection	IEC standard: IP67		IEC standard: IP50		IEC standard: IP68	IEC standard: IP50
Other	Repeat accuracy: 1 mm max.			Repeat accuracy: 0.5 mm max.		

Item	Type	Application-specific models				
	Glass-substrate-alignment		Glass-substrate-mapping			
	All other models	E32-L66	E32-A09	E32-A09H	E32-A09H2	
Ambient operating temperature *1	-40°C to 70°C		0°C to 300°C *3, *5	-40°C to 70°C	-40°C to 150°C *4	-40°C to 300°C *3
Ambient humidity *1	35% to 85%					
Fiber material	Plastic (polyethylene coating)	Glass (SUS spiral coating)	Plastic (polyethylene coating)	Plastic (fluororesin coating)	Glass (SUS spiral coating)	
Degree of protection	IEC standard: IP40					

*1. There must be no icing or condensation within the range specified for the ambient operating temperature.
 *2. For continuous operation, use the products within a temperature range of -40°C to 90°C.
 *3. The maximum temperature that can be withstood varies with the location. Refer to dimensions diagrams for details.
 *4. For continuous operation, use the products within a temperature range of -40°C to 130°C.
 *5. These values are based on the assumption that there are no repeated sudden changes in temperature.

Dimensions

Through-beam Fiber Units

Standard/Flexible Models

Free-cut Indicates models that allow free cutting.

E32-TC200
E32-T11R

Free-cut

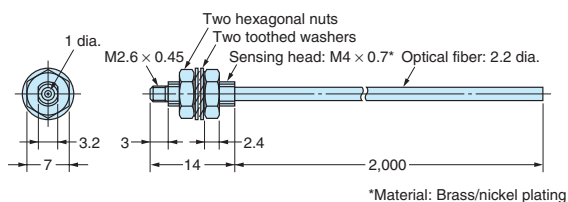

E32-TC200E

Free-cut

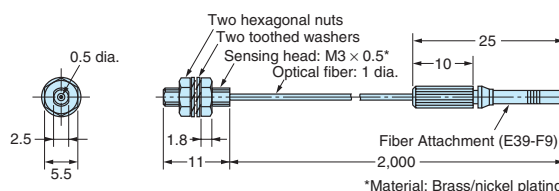

E32-TC200A
E32-T21R

Free-cut

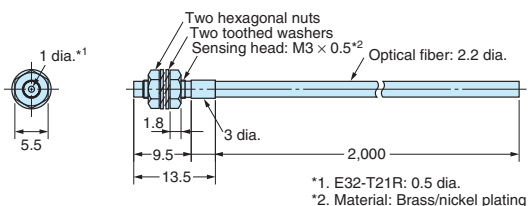

E32-T22
E32-T22R

Free-cut

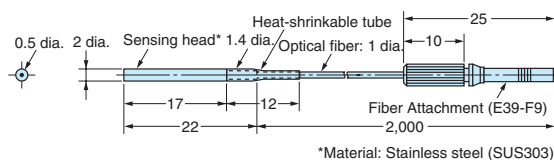

E32-T12
E32-T12R

Free-cut

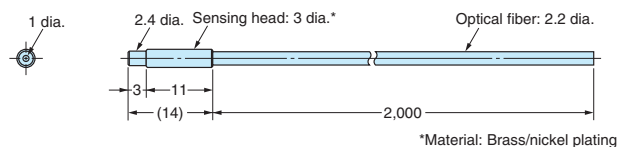

E32-T222
E32-T222R

Free-cut

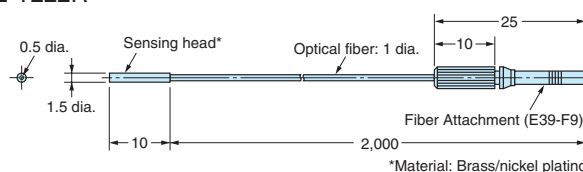

E32-T15X
E32-T15XR

Free-cut

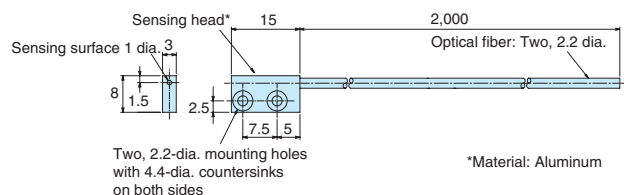

E32-T25X
E32-T25XR

Free-cut

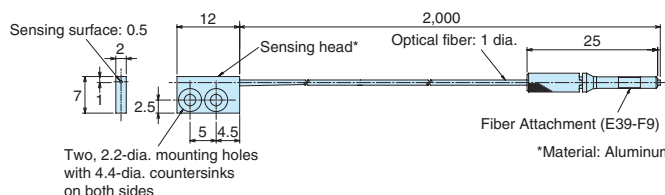

E32-TC200B(B4)
E32-TC200BR(B4R)

Free-cut

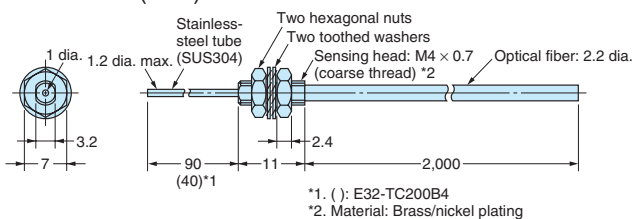

E32-TC200(F4)
E32-TC200F(F4R)

Free-cut

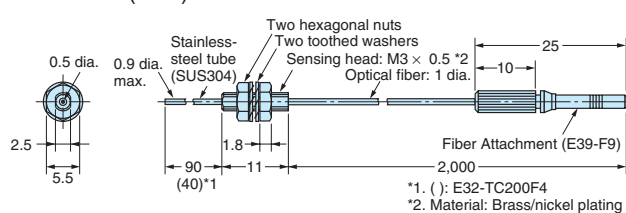

E32-T14L
E32-T14LR

Free-cut

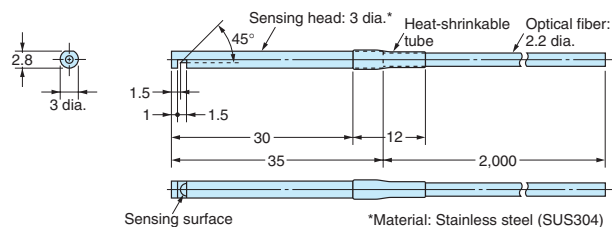

E32-T24
E32-T24R

Free-cut

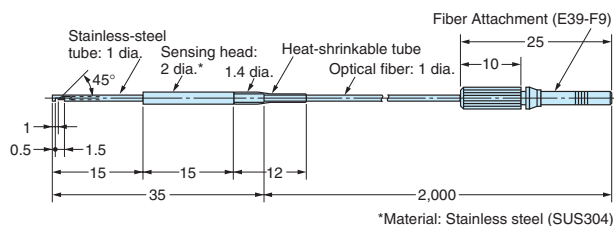

Dimensions

Through-beam Fiber Units

Standard/Flexible Models

Free-cut Indicates models that allow free cutting.

E32-T15Y
E32-T15YR

Free-cut

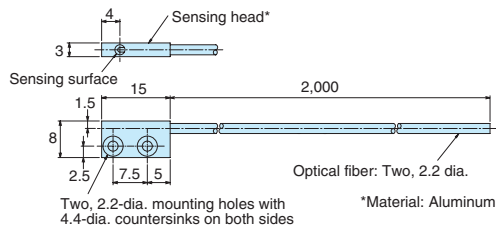

E32-T25Y
E32-T25YR

Free-cut

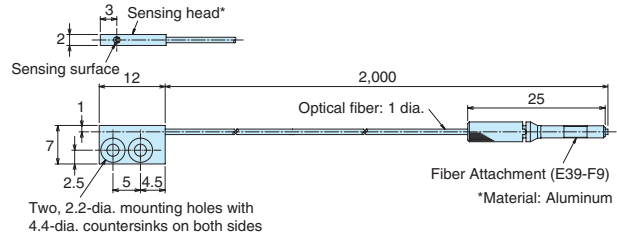

E32-T15Z
E32-T15ZR

Free-cut

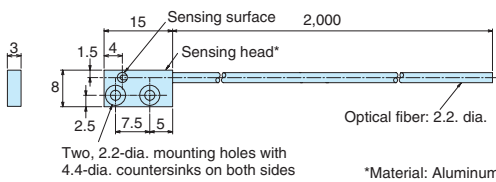

E32-T25Z
E32-T25ZR

Free-cut

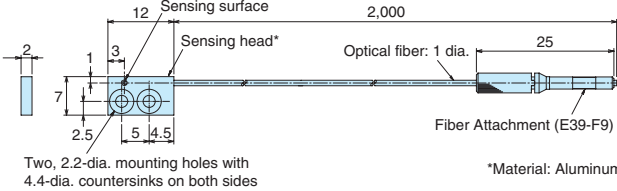

Break-resistant/Coated Models

E32-T11
E32-T11U

Free-cut

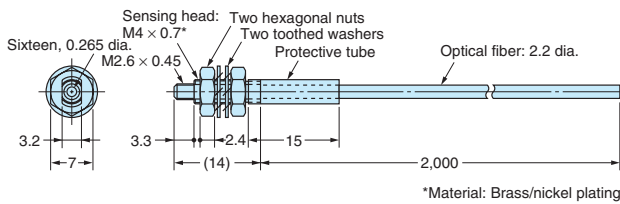

E32-T21

Free-cut

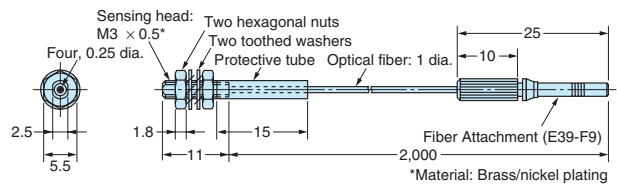

E32-T12B

Free-cut

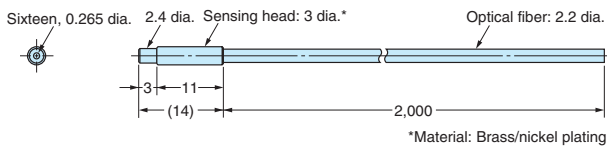

E32-T221B

Free-cut

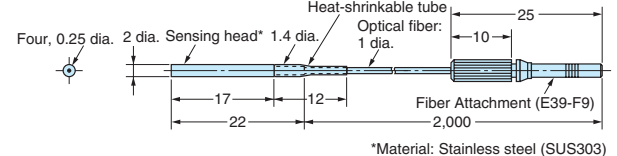

E32-T22B

Free-cut

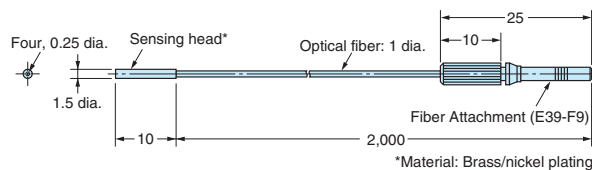

E32-T15XB

Free-cut

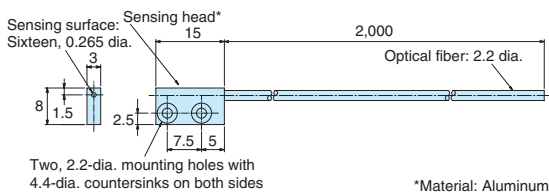

E32-T25XB

Free-cut

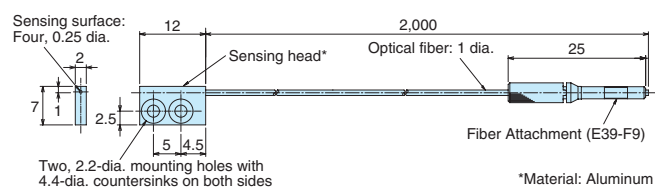

Through-beam Fiber Units

Right angle Models

E32-T11N

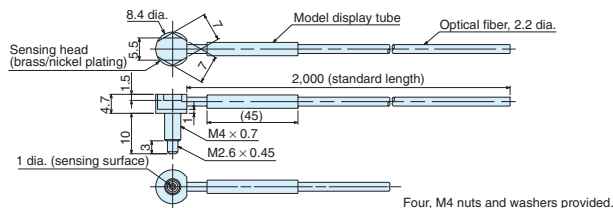

Long-distance/High-power Models

E32-T17L

Free-cut

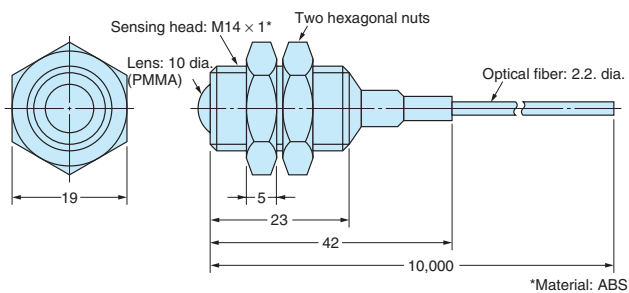

E32-T14

Free-cut

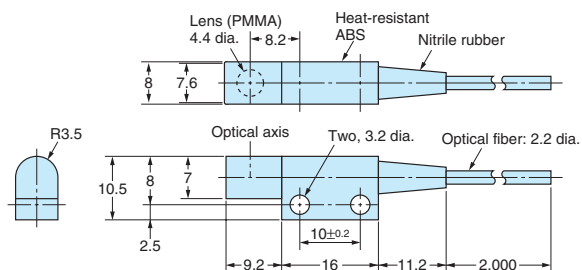

E32-T11L

Free-cut

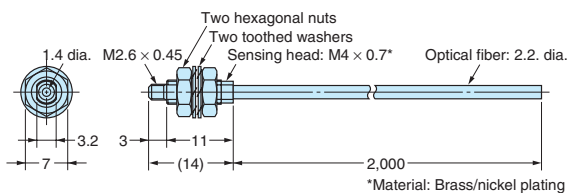

E32-T12L

Free-cut

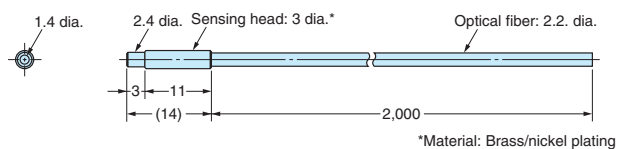

E32-T21L

Free-cut

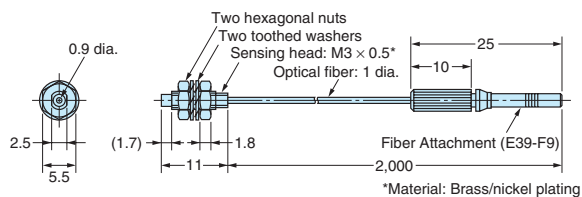

E32-T22L

Free-cut

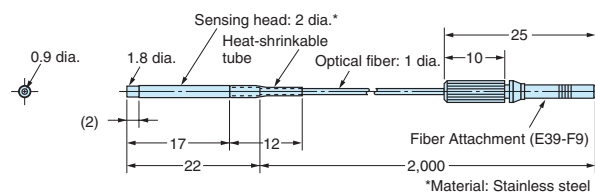

Ultracompact/Thin-sleeve Models

E32-T223R

Free-cut

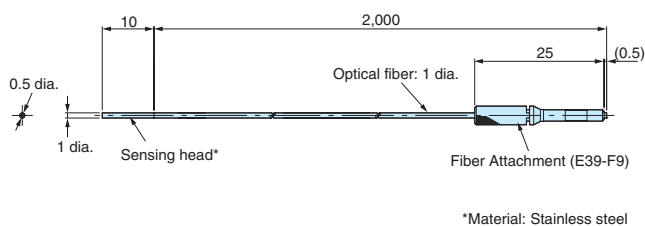

E32-T33-S5

Free-cut

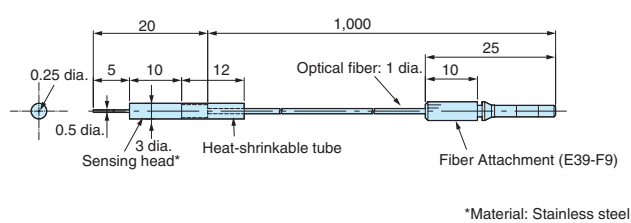

Dimensions

Through-beam Fiber Units

Ultracompact/Thin-sleeve Models

Free-cut Indicates models that allow free cutting.

E32-T333-S5

Free-cut

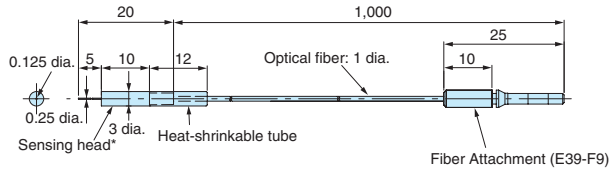

*Material: Stainless steel

Note: The Fiber Attachment is attached with adhesive and cannot be removed.

E32-T334-S5

Free-cut

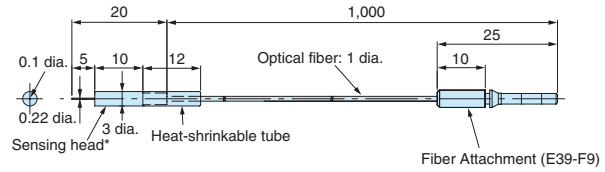

*Material: Stainless steel

Note: The Fiber Attachment is attached with adhesive and cannot be removed.

Fine-beam (narrow vision field) Models

E32-T22S

Free-cut

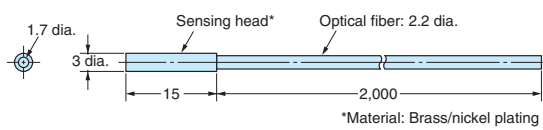

*Material: Brass/nickel plating

E32-T24S

Free-cut

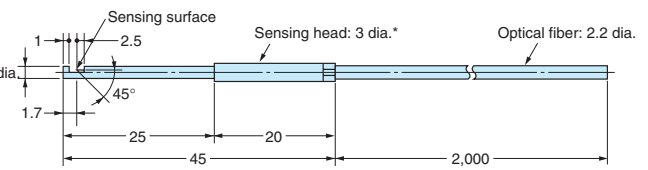

*Material: Stainless steel (SUS303)

Area-sensing Models

E32-T16W
E32-T16WR

Free-cut

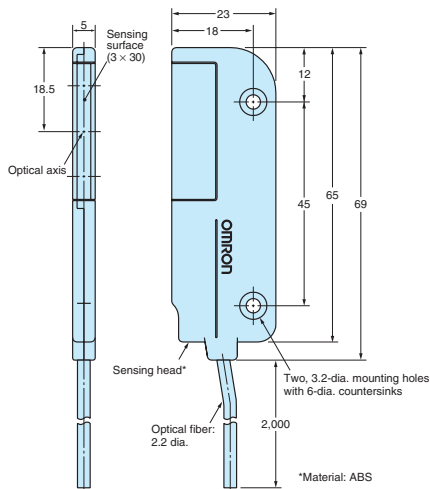

*Material: ABS

E32-M21

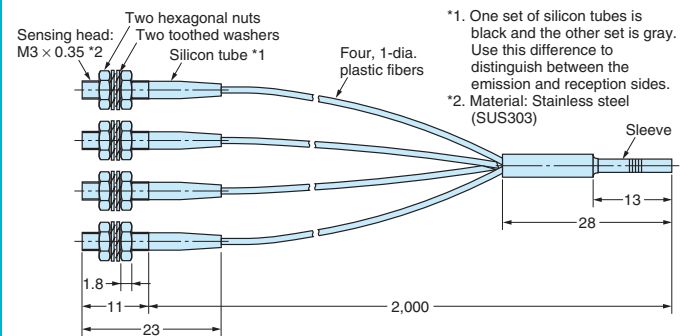

*1. One set of silicon tubes is black and the other set is gray. Use this difference to distinguish between the emission and reception sides.
*2. Material: Stainless steel (SUS303)

Through-beam Fiber Units

Area-sensing Models

E32-ET16WR-1

Free-cut

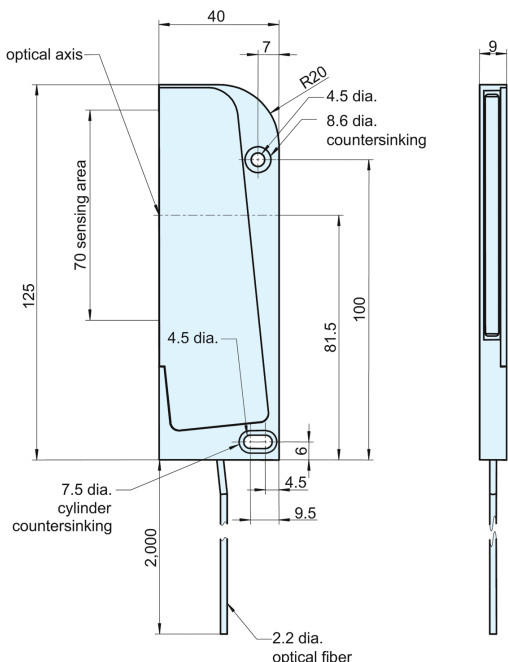

E32-ET16WR-2

Free-cut

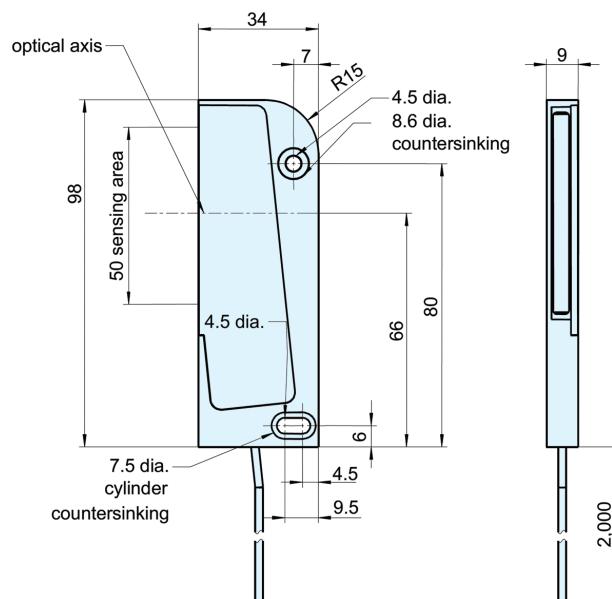

E32-T16P
E32-T16PR

Free-cut

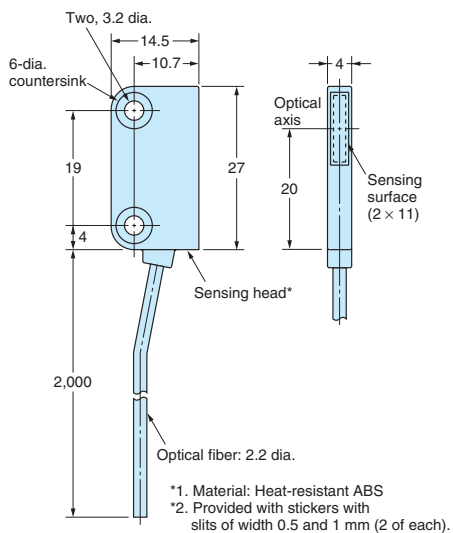

E32-T16J
E32-T16JR

Free-cut

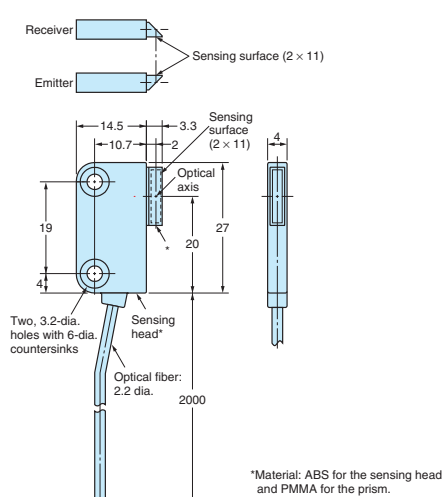

E32-T16

Free-cut

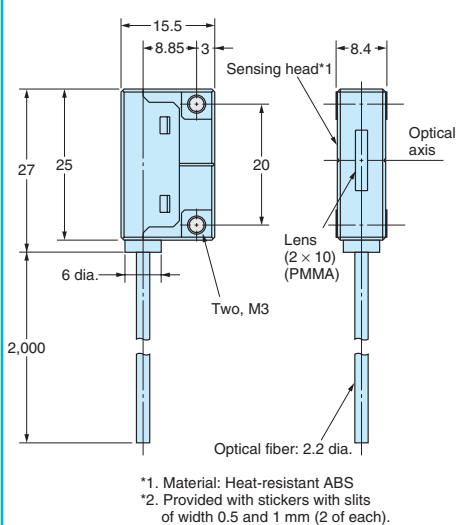

Heat-resistant Models

E32-T51

Free-cut

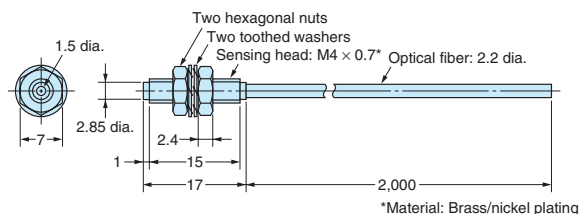

Note: The maximum allowable temperature is 150°C. The maximum allowable temperature for continuous operation is 130°C.

E32-T54

Free-cut

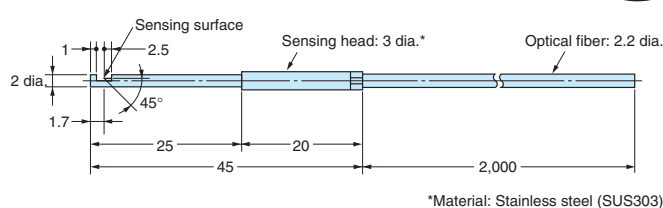

Note: The maximum allowable temperature is 150°C. The maximum allowable temperature for continuous operation is 130°C.

Dimensions

Through-beam Fiber Units

Heat-resistant Models

Free-cut Indicates models that allow free cutting.

E32-T81R-S

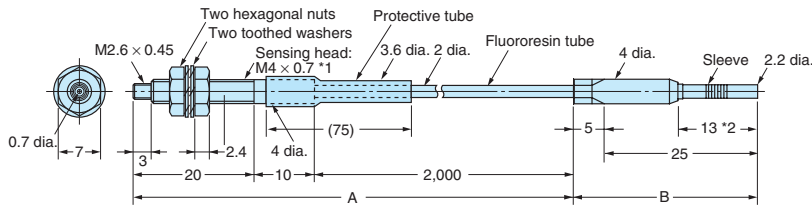

*1. Material: Stainless steel (SUS303)

Note: The maximum allowable temperature for section A and B are 200°C. and 110°C, respectively. The section inserted into Amplifier unit (indicated by *2), however, must stay within the Amplifier Unit's operating temperature range.

E32-T84S-S

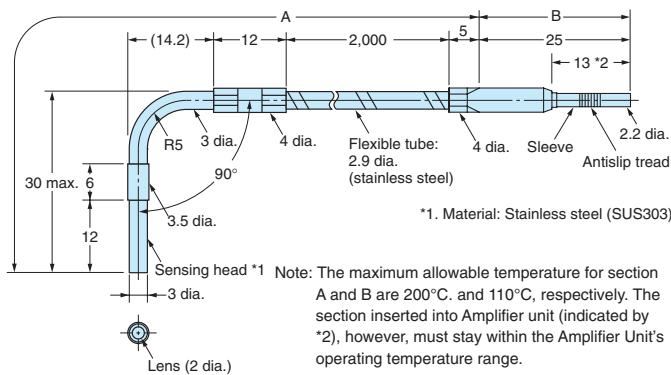

*1. Material: Stainless steel (SUS303)

Note: The maximum allowable temperature for section A and B are 200°C. and 110°C, respectively. The section inserted into Amplifier unit (indicated by *2), however, must stay within the Amplifier Unit's operating temperature range.

E32-T61-S

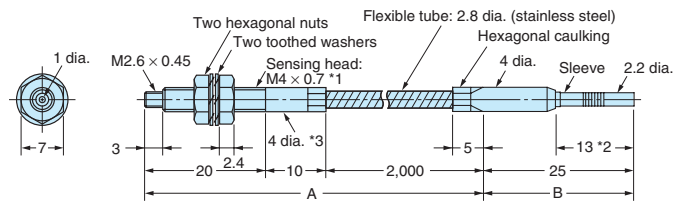

*1. Material: Stainless steel (SUS303)

*3. The diameter is 6 mm if the fiber length exceeds 10 m.

Note: The maximum allowable temperature for section A and B are 200°C. and 110°C, respectively. The section inserted into Amplifier unit (indicated by *2), however, must stay within the Amplifier Unit's operating temperature range.

Chemical-resistant Models

E32-T11F

Free-cut

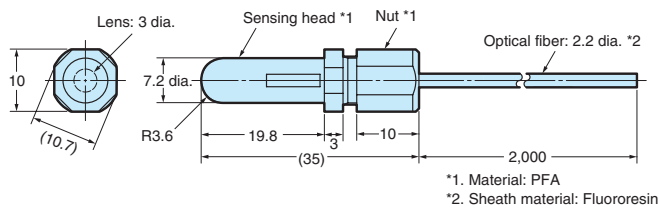

*1. Material: PFA
*2. Sheath material: Fluororesin

E32-T12F

Free-cut

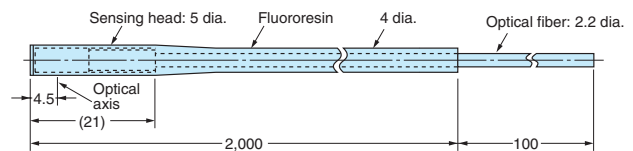

E32-T14F

Free-cut

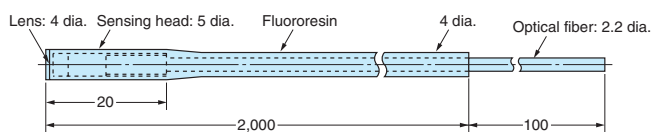

E32-T51F

Free-cut

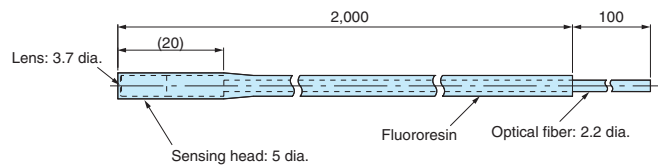

E32-T81F-S

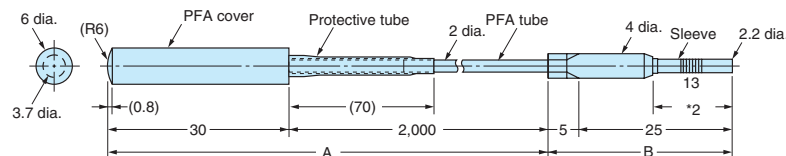

Note: The maximum allowable temperature for section A and B are 200°C. and 110°C, respectively. The section inserted into Amplifier unit (indicated by *2), however, must stay within the Amplifier Unit's operating temperature range.

Through-beam Fiber Units

Vacuum-resistant Models

E32-T51V

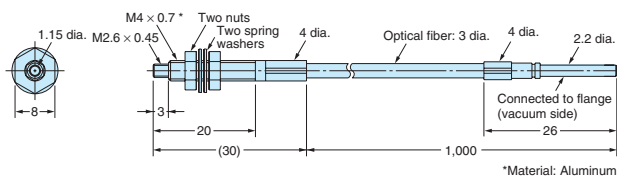

E32-T54V

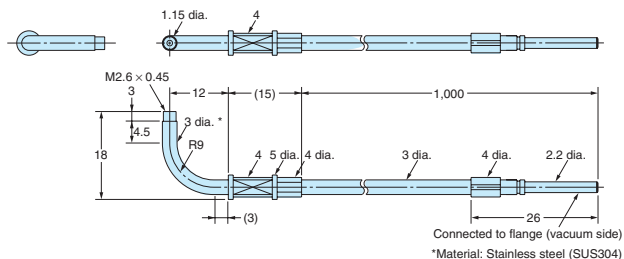

E32-T84SV

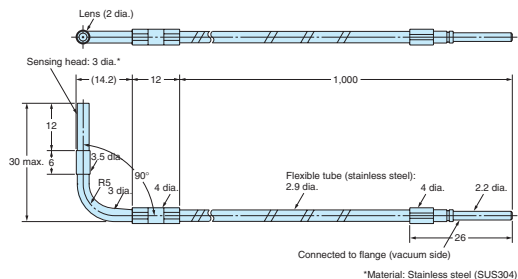

E39-F1V

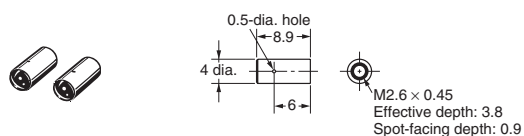

E32-VF4

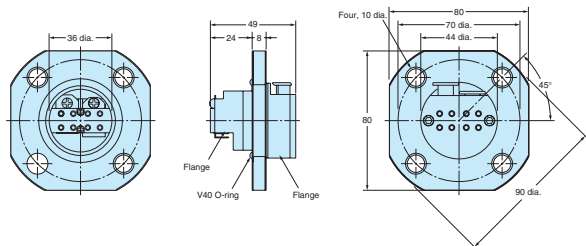

- Note 1. Perform mounting so that the V15 O-ring is on the atmospheric-pressure side of the vacuum chamber wall.
2. Mounting-hole cutout dimensions: 14.5 dia. ±0.2 mm

E32-VF1

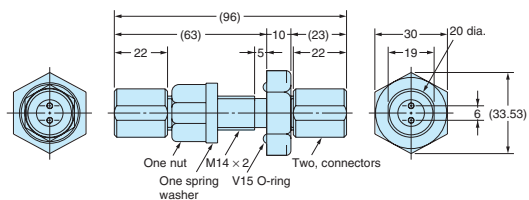

- Note 1. Perform mounting so that the V15 O-ring is on the atmospheric-pressure side of the vacuum chamber wall.
2. Mounting-hole cutout dimensions: 14.5 dia. ±0.2 mm

Dimensions

Fiber Units with Reflective Sensors

Standard/Flexible Models

(Free-cut) Indicates models that allow free cutting.

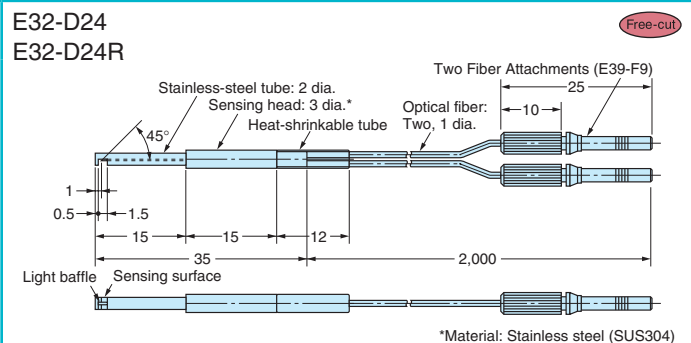
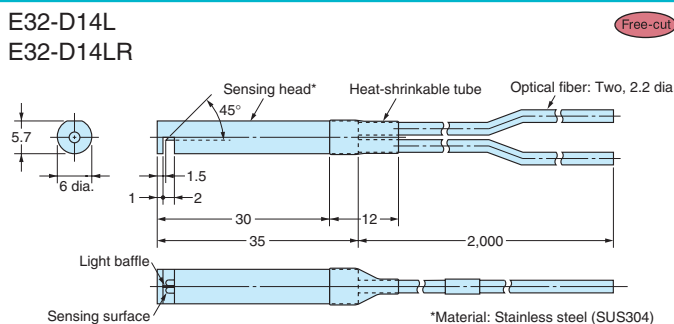
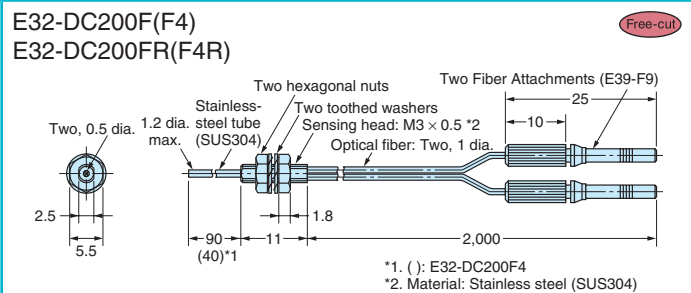
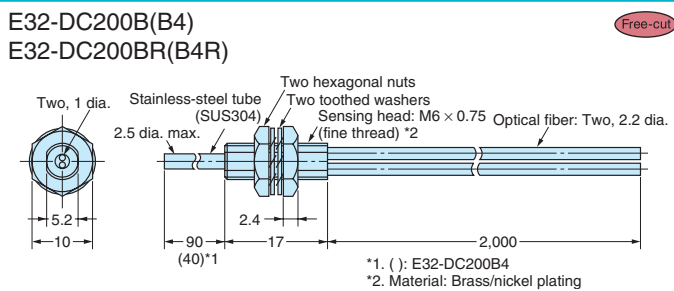
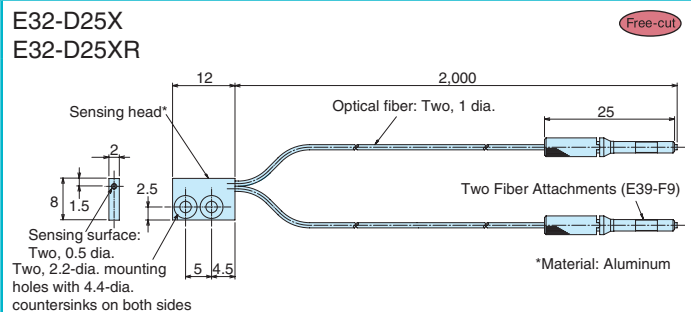
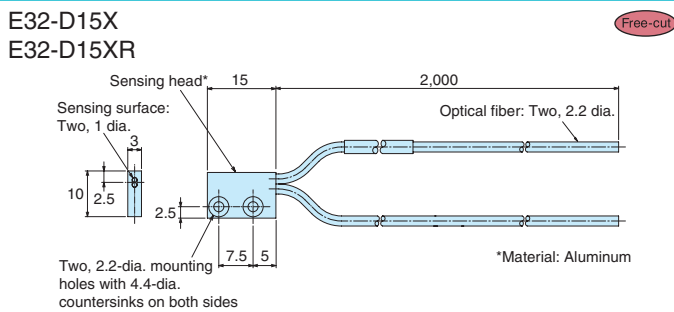
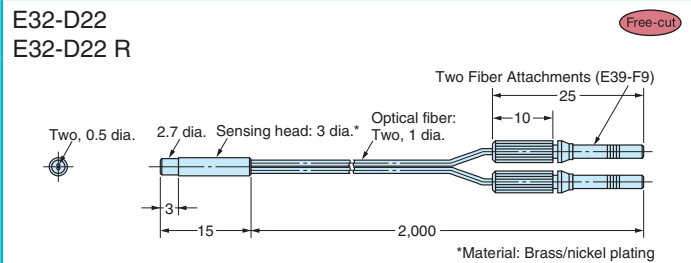
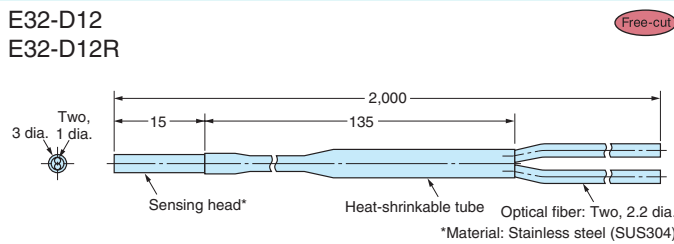
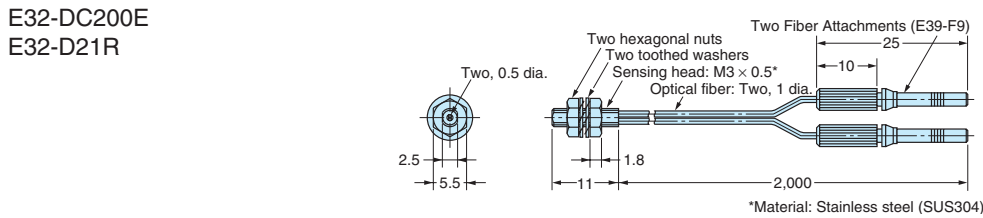
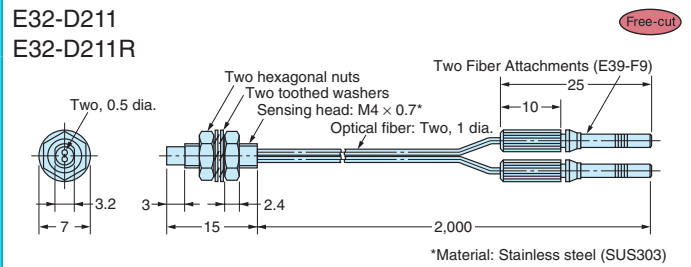
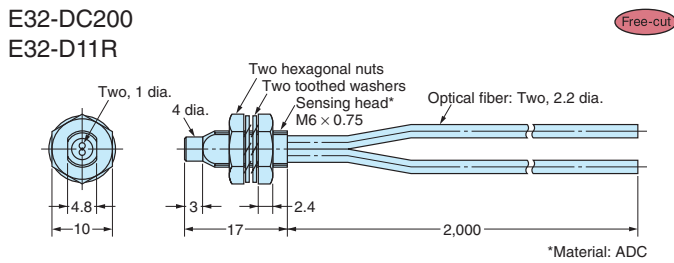

Fiber Units with Reflective Sensors

Standard/Flexible Models

E32-D15Y
E32-D15YR

Free-cut

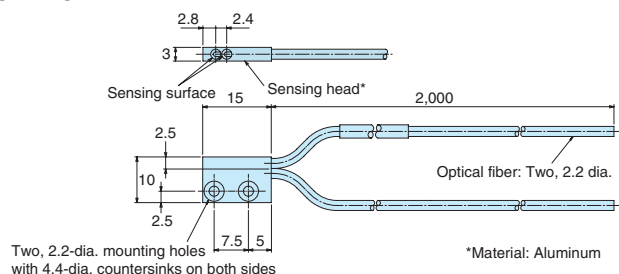

E32-D25Y
E32-D25YR

Free-cut

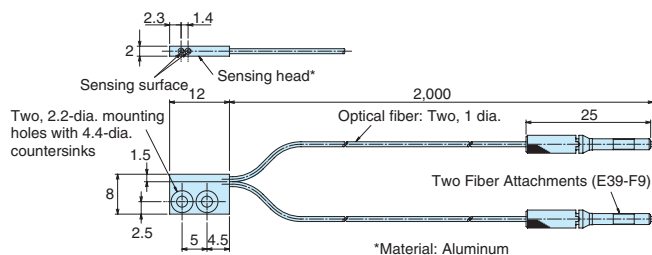

E32-D15Z
E32-D15ZR

Free-cut

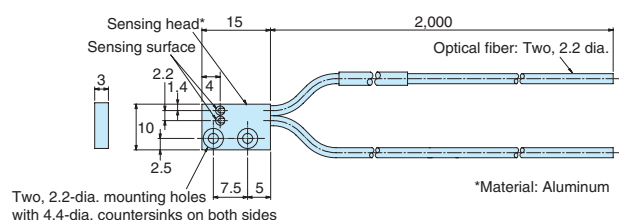

E32-D25Z
E32-D25ZR

Free-cut

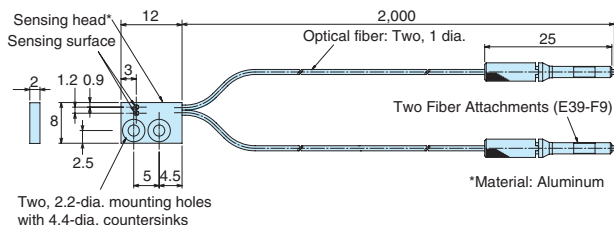

Break-resistant/Coated Models

E32-D11
E32-D11U

Free-cut

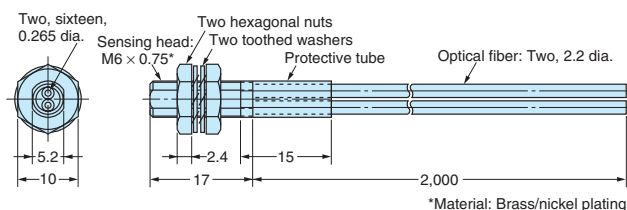

E32-D21B

Free-cut

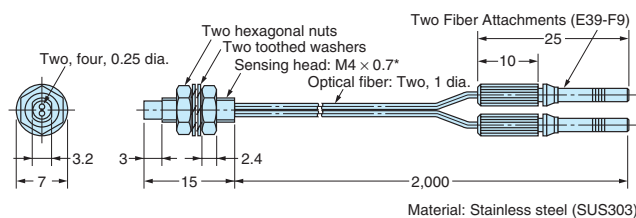

E32-D21

Free-cut

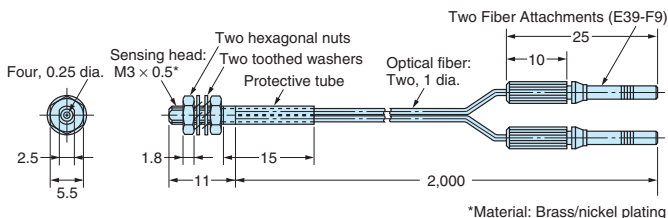

E32-D221B

Free-cut

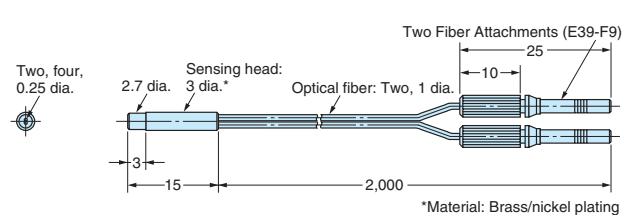

E32-D22B

Free-cut

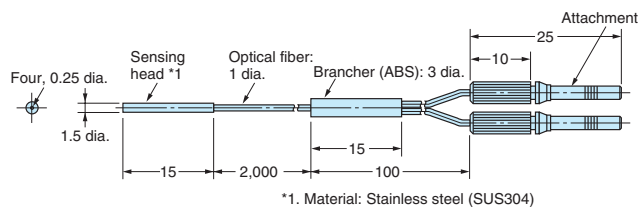

Note: The Attachment is attached with adhesive and cannot be removed.

Dimensions

Fiber Units with Reflective Sensors

Break-resistant/Coated Models

Free-cut Indicates models that allow free cutting.

E32-D15XB

Free-cut

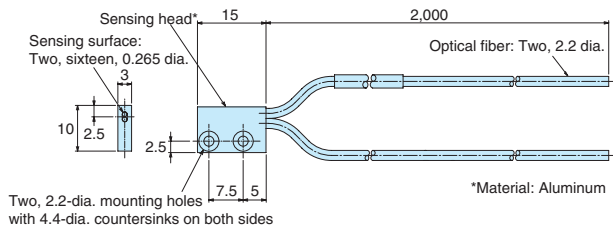

E32-D25XB

Free-cut

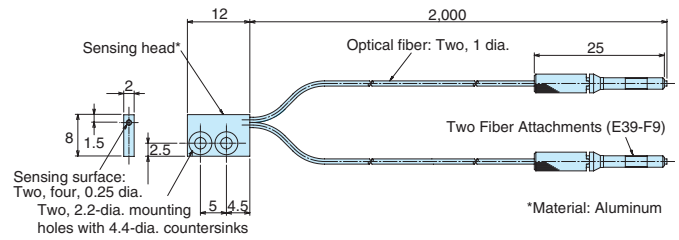

Right angle Models

E32-D11N

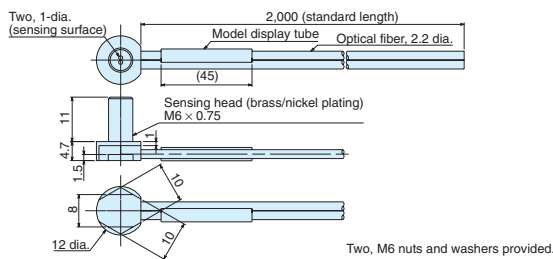

E32-C11N

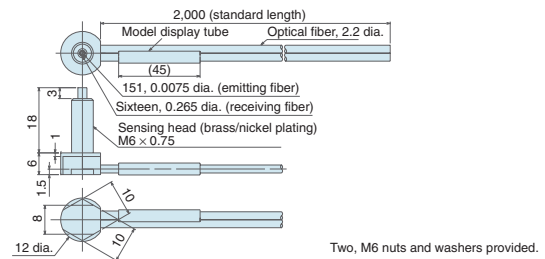

E32-C31N

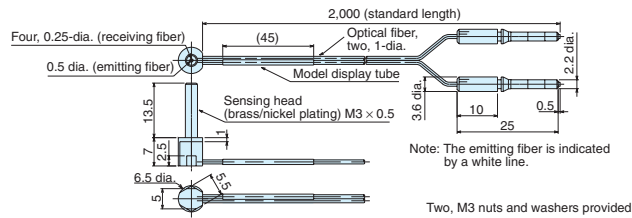

Long-distance/High-power Models

E32-D16

Free-cut

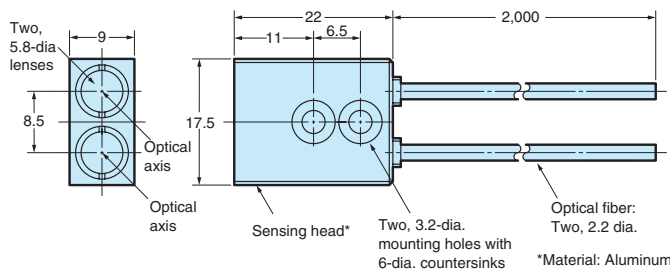

E32-D11L

Free-cut

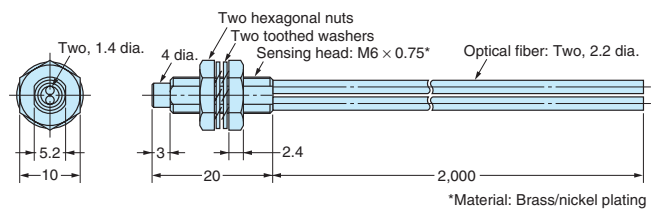

E32-D21L

Free-cut

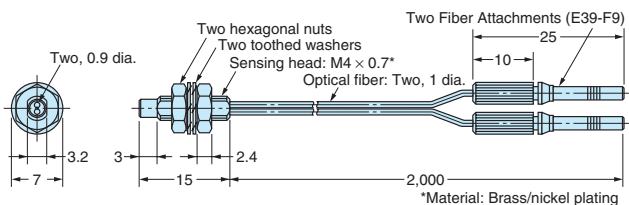

E32-D22L

Free-cut

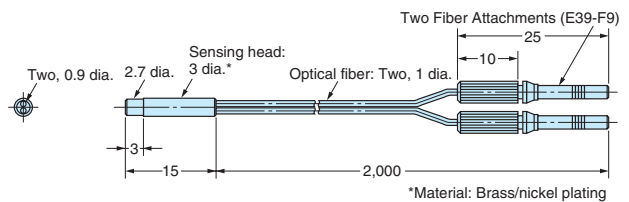

Fiber Units with Reflective Sensors

Ultracompact/Thin-sleeve Models

E32-D33

Free-cut

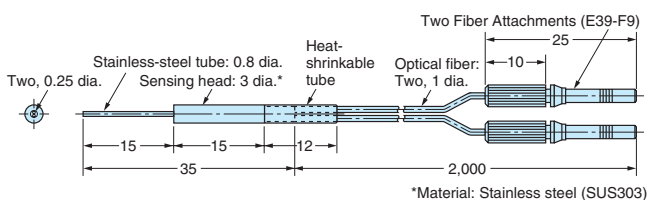

E32-D331

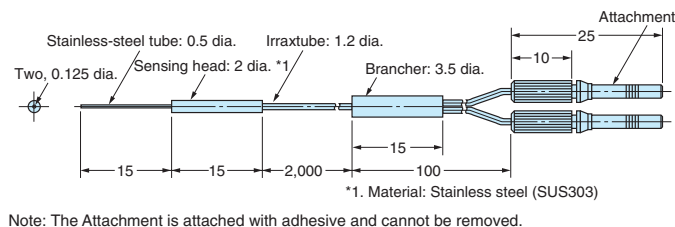

Coaxial/Small-spot Models

E32-CC200

Free-cut

E32-CC200R

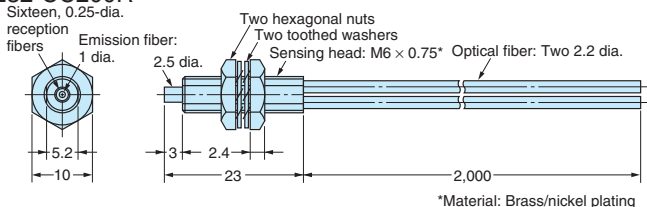

Note: There is a white line on the fiber that is inserted in the emitter-side port.

E32-D32L

Free-cut

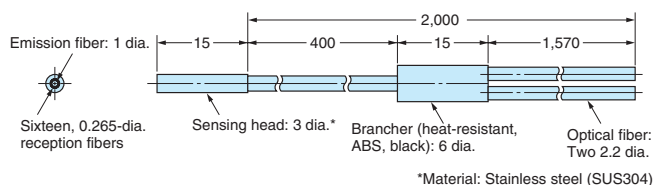

Note: There is a yellow dotted line on the fiber that is inserted in the emitter-side port.

E32-C31

Free-cut

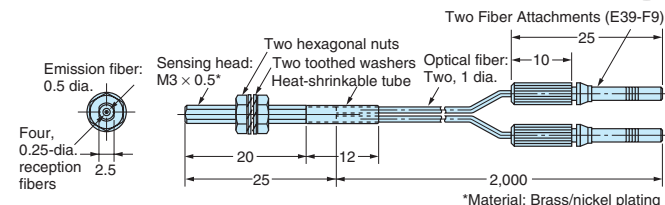

Note 1. There is a white line on the fiber that is inserted in the emitter-side port.
2. The core diameter of the sensing head is assumed to lie in the range 2.44 to 2.49 mm.

E32-D32

Free-cut

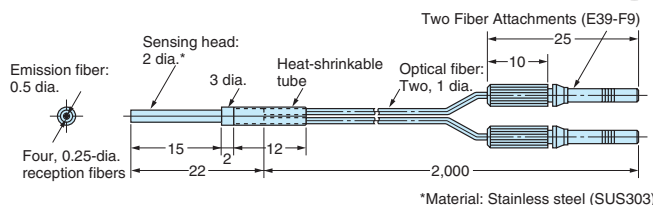

Note: There is a white line on the fiber that is inserted in the emitter-side port.

E32-C41

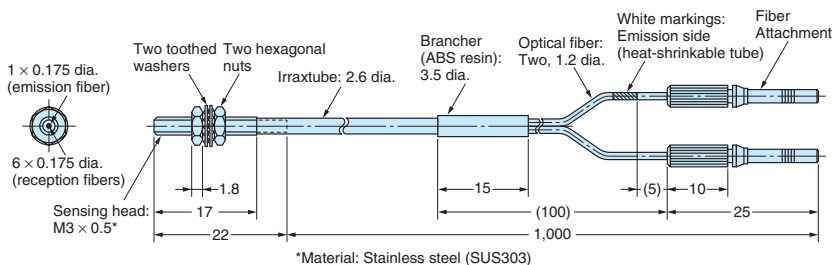

Note: The Attachment is attached with adhesive and cannot be removed.

E32-C42

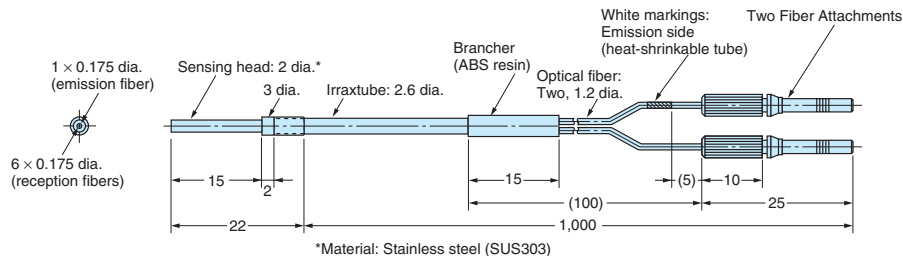

Note: The Attachment is attached with adhesive and cannot be removed.

Dimensions

Fiber Units with Reflective Sensors

Area-sensing Models

Free-cut Indicates models that allow free cutting.

E32-D36P1

Free-cut

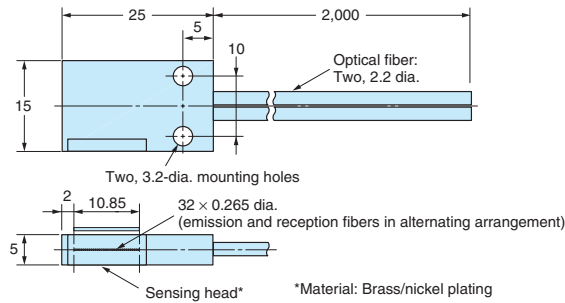

Retroreflective Fiber Models

E32-R21

(An E39-R3 Reflector is provided as an accessory.)

Free-cut

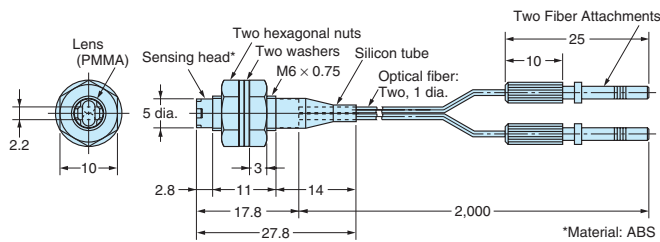

E32-R16

(An E39-R1 Reflector is provided as an accessory.)

Free-cut

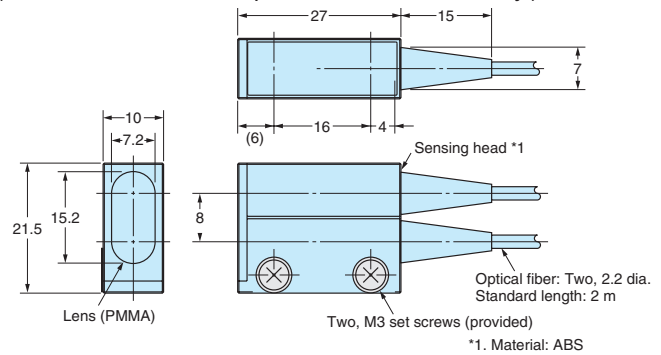

Limited-reflective Models

E32-L24S

Free-cut

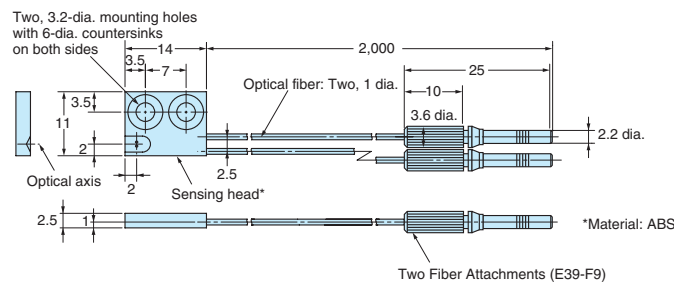

E32-L16

Free-cut

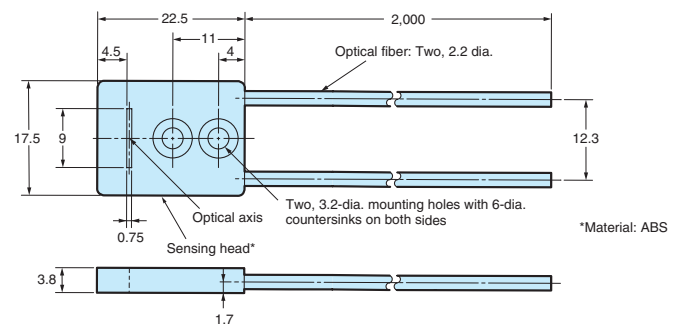

E32-L24L

Free-cut

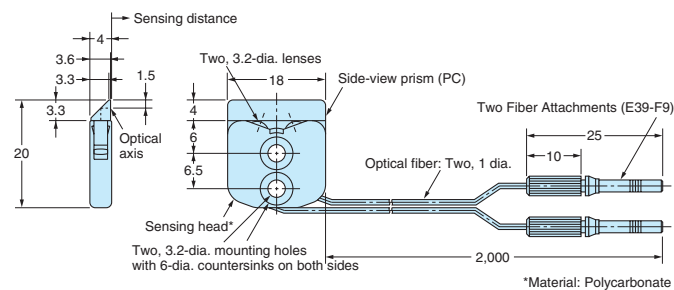

E32-L25L

Free-cut

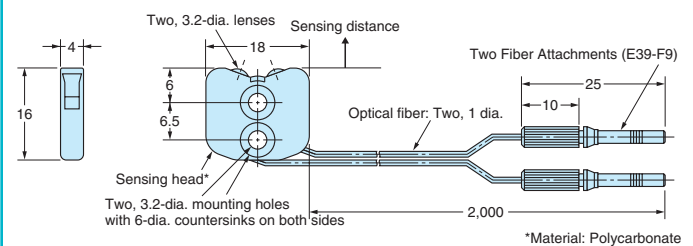

Fiber Units with Reflective Sensors

Limited-reflective Models

E32-L25

Free-cut

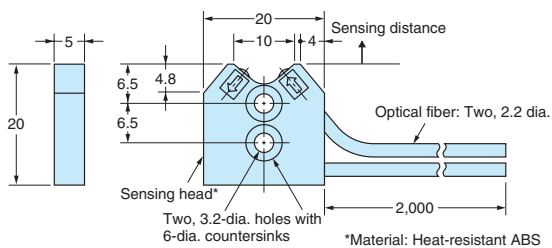

Note: There is a white line on the fiber that is inserted in the emitter-side port.

E32-L25A

Free-cut

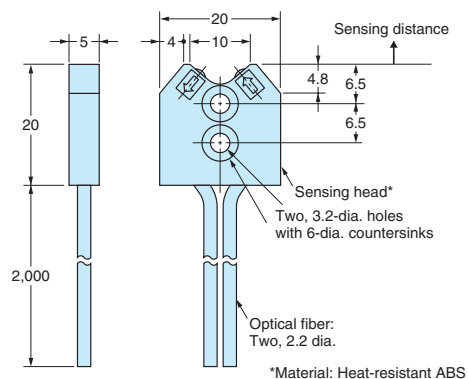

Note: There is a white line on the fiber that is inserted in the emitter-side port.

E32-L86

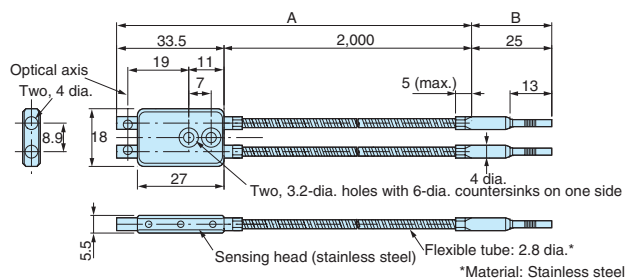

Note: The maximum allowable temperature for section A and B are 200°C. and 110°C, respectively. The section inserted into Amplifier unit (indicated by *2), however, must stay within the Amplifier Unit's operating temperature range.

Heat-resistant Models

E32-D51

Free-cut

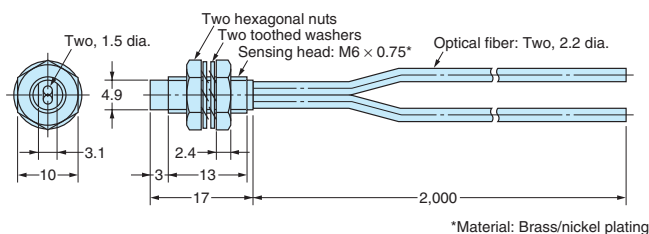

Note: The maximum allowable temperature is 150°C. The maximum allowable temperature for continuous operation is 130°C.

E32-D81R-S

E32-D81R

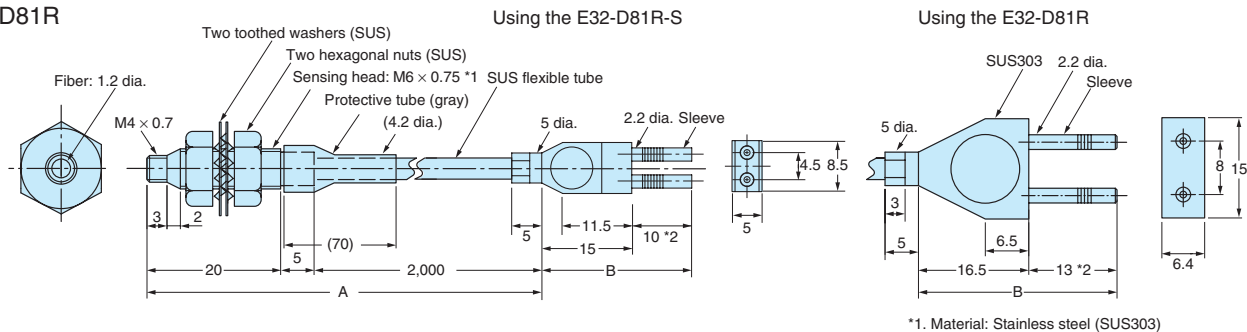

Note: The maximum allowable temperature for section A and B are 200°C. and 110°C, respectively. The section inserted into Amplifier unit (indicated by *2), however, must stay within the Amplifier Unit's operating temperature range.

Dimensions

Fiber Units with Reflective Sensors

Heat-resistant Models

Free-cut Indicates models that allow free cutting.

E32-D61-S
E32-D61

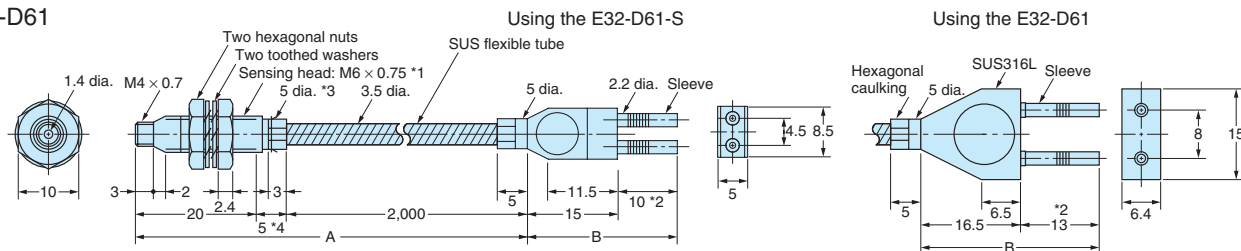

*1. Material: Stainless steel (SUS303)
*3. The diameter is 6 if the fiber length exceeds 10 m.
*4. The diameter is 10 if the fiber length exceeds 10 m.

Note: The maximum allowable temperature for section A and B are 200°C. and 110°C, respectively. The section inserted into Amplifier unit (indicated by *2), however, must stay within the Amplifier Unit's operating temperature range.

E32-D73-S
E32-D73

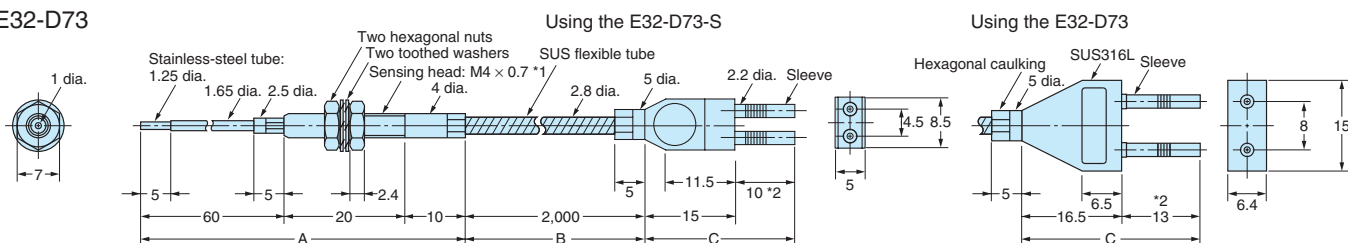

*1. Material: Stainless steel (SUS303)

Note: The maximum allowable temperature for section A and B are 200°C. and 110°C, respectively. The section inserted into Amplifier unit (indicated by *2), however, must stay within the Amplifier Unit's operating temperature range.

Chemical-resistant Models

E32-D12F

Free-cut

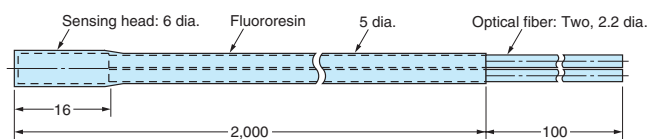

E32-D14F

Free-cut

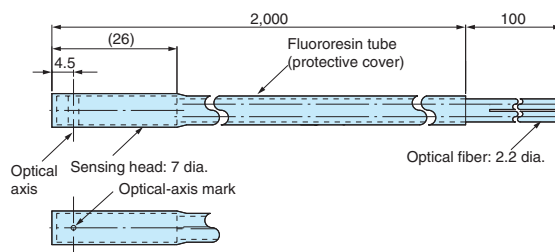

Application-specific Fiber Units

Label-detection Models

E32-G14

Free-cut

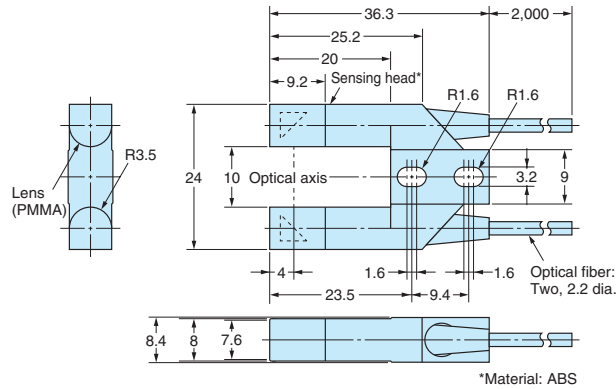

Liquid-level Detection Models

E32-D36T

Free-cut

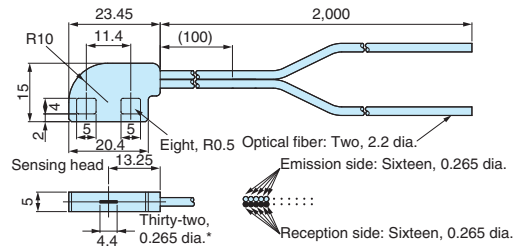

E32-L25T

Free-cut

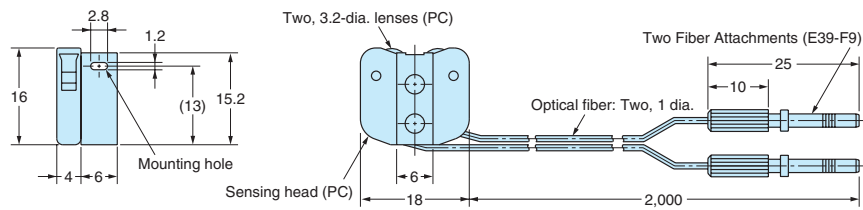

E32-A01

Free-cut

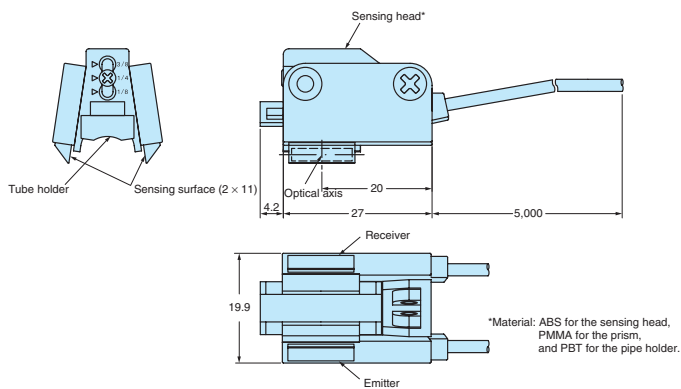

E32-A02

Free-cut

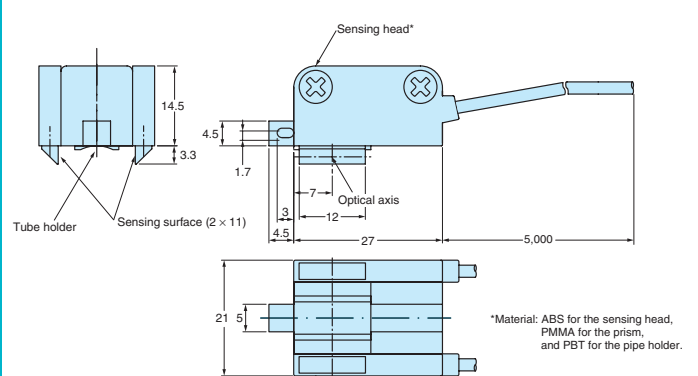

Dimensions

Application-specific Fiber Units

Liquid-level Detection Models

Free-cut Indicates models that allow free cutting.

E32-D82F1
E32-D82F2

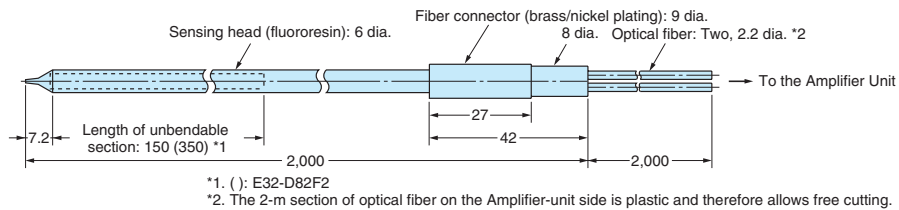

Models for Glass-substrate Alignment/Mapping

E32-A08
E32-A07E1(E2)

Free-cut

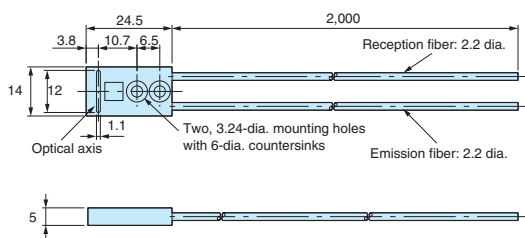

E32-L66

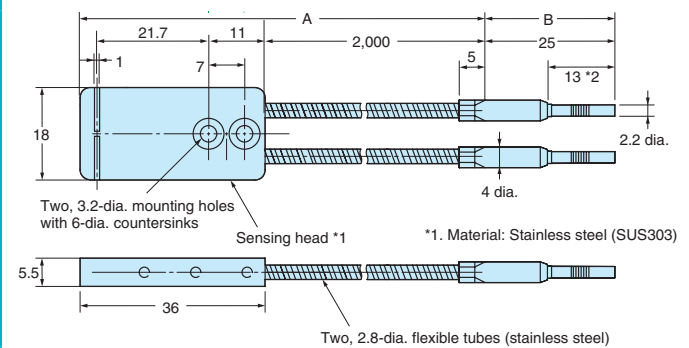

Note: The maximum allowable temperature for section A and B are 200°C. and 110°C, respectively. The section inserted into Amplifier unit (indicated by *2), however, must stay within the Amplifier Unit's operating temperature range.

E32-A09
E32-A09H

Free-cut

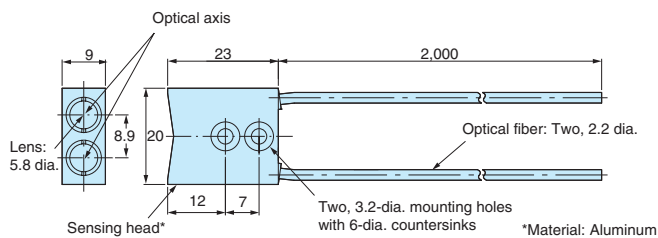

E32-A09H2

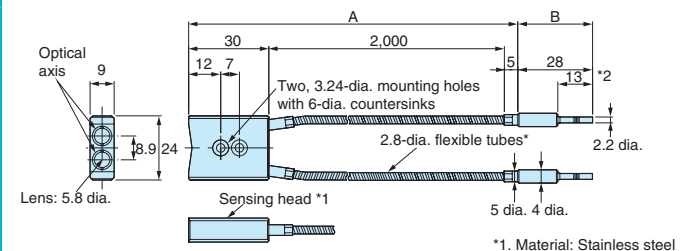

Note: The maximum allowable temperature for section A and B are 200°C. and 110°C, respectively. The section inserted into Amplifier unit (indicated by *2), however, must stay within the Amplifier Unit's operating temperature range.

Wafer-mapping Models

E32-A03

Free-cut

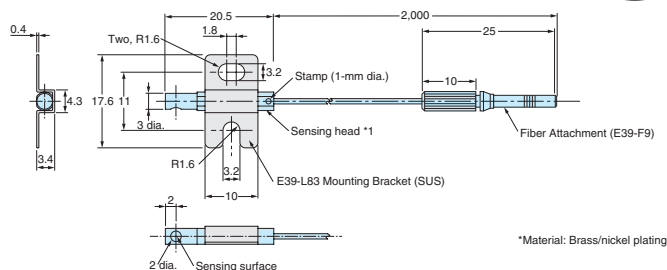

E32-A03-1

Free-cut

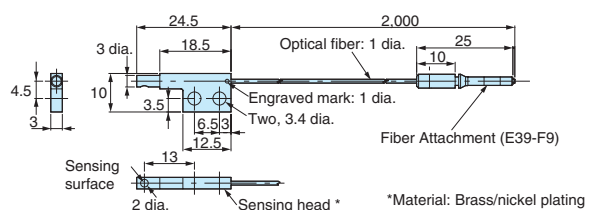

Application-specific Fiber Units

Wafer-mapping Models

Note: Use the stamped surface and its opposing surface as installation (reference) surfaces.

E32-A04

Free-cut

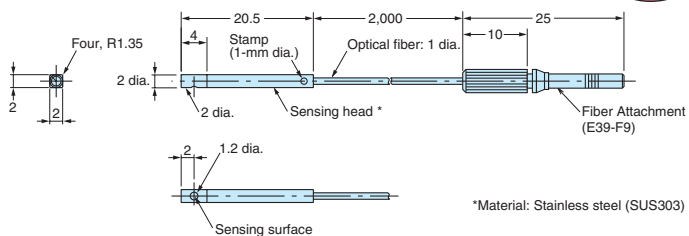

Note: Use the stamped surface and its opposing surface as installation (reference) surfaces.

Note: Use the stamped surface and its opposing surface as installation (reference) surfaces.

E32-A04-1

Free-cut

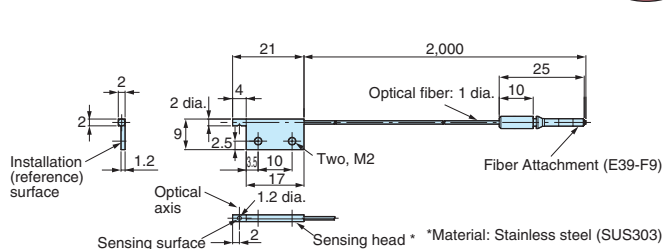

Dimensions

Accessories

Protective Spiral Tubes

E39-F32A/F32A5
E39-E32B/F32B5

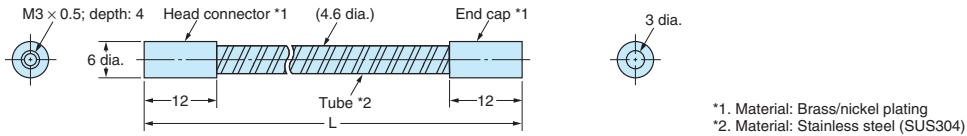

Note: 1. The length L is 1,000 for the E39-F32A/-F32B and 500 for the E39-F32A5/-F32B5.
2. The E39-F32B(5) consists of two E39-F32A(5)s.

E39-F32C/F32C5

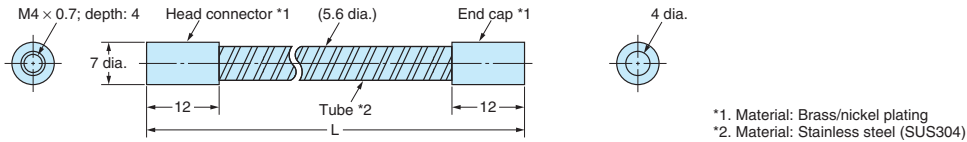

Note: The length L is 1,000 for the E39-F32C and 500 for the E39-F32C5.

E39-F32D/F32D5

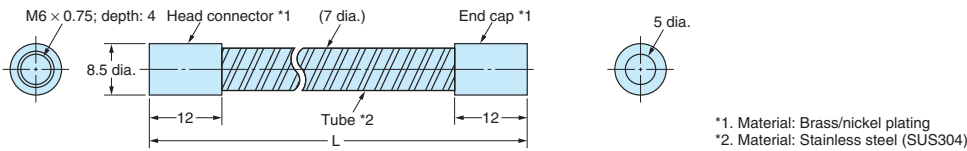

Note: The length L is 1,000 for the E39-F32D and 500 for the E39-F32D5.

Other Accessories

Fiber Cutter
E39-F4

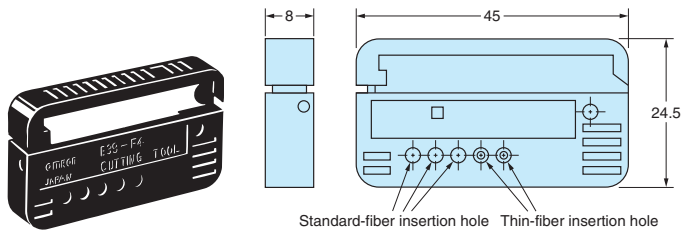

Thin-fiber Attachments
E39-F9

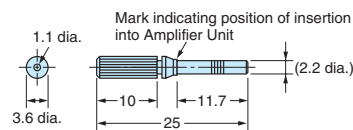

Note: Two per set.
*Provided with thin-fiber models.

Fiber Connector
E39-F10

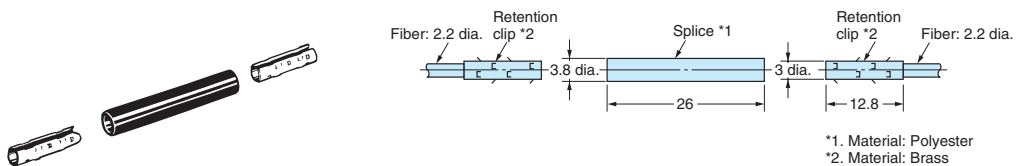

Fiber Connector
E39-F13
E39-F14
E39-F15

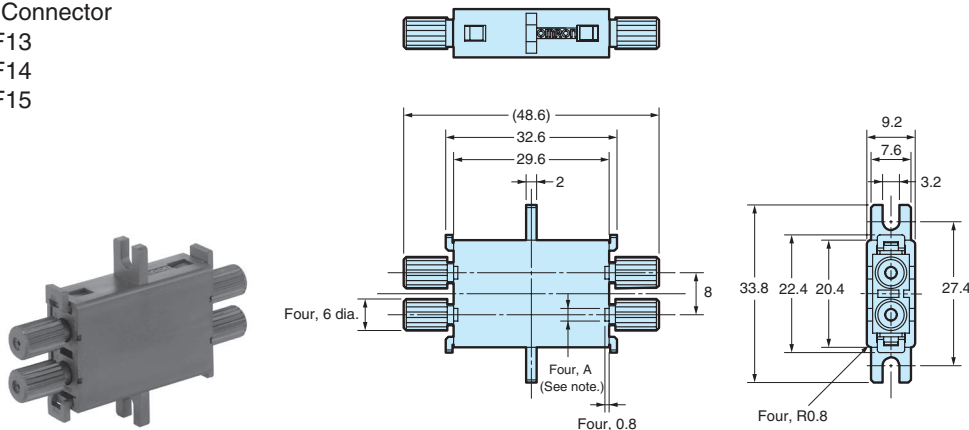

Note: Dimension A varies with the model number as shown in the following table.

Model	Dimension A
E39-F13	2.4
E39-F14	1.2
E39-F15	2.4/1.2

Accessories

Other Accessories

Sleeve Bender
E39-F11

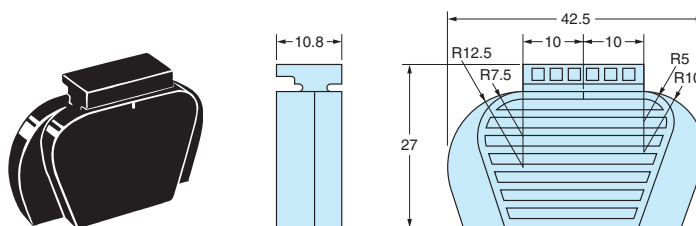

Lens Units

Lens Units
E39-F1

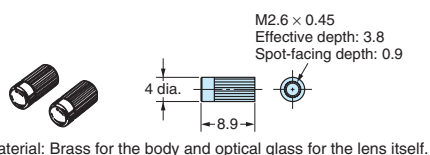

Material: Brass for the body and optical glass for the lens itself.

Note: Two per set.

Side-view units
E39-F2

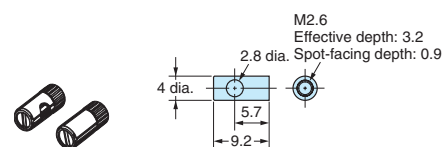

Material: Brass for the body and optical glass for the lens itself.

Note: Two per set.

Reflection Unit with Lens
E39-F3

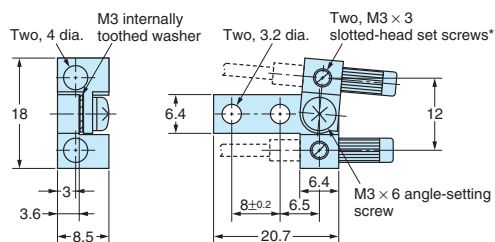

Material: Brass for the body and aluminum for the base.

* Secure the fiber head with the slotted-head set screws. Do not insert a lens (E39-F1).

Lens Unit for Reflective Fiber Units
E39-F3A

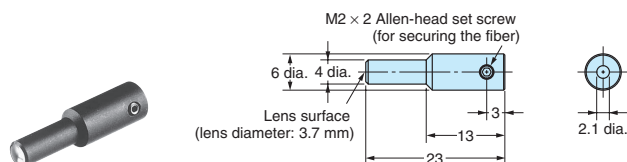

Material: Aluminum for body and optical glass, for the lens.

Note: This is the Lens Unit for the E32-D32 and E32-C42.

Lens Unit for Reflective Fiber Units
E39-F3A-5

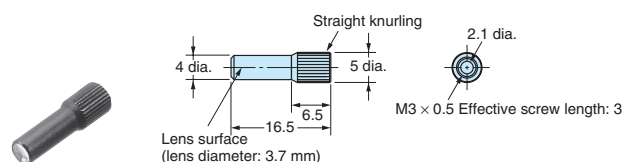

Material: Aluminum for body and optical glass, for the lens.

Note: This is the Lens Unit for the E32-C31 and E32-C41.

Lens Unit for Reflective Fiber Units
E39-F3B

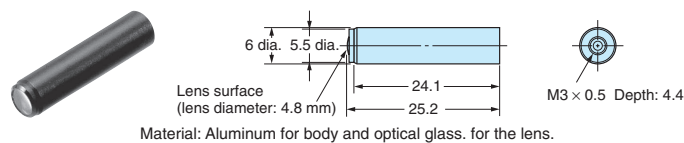

Material: Aluminum for body and optical glass, for the lens.

Note: This is the Lens Unit for the E32-C31 and E32-C41.

Lens Unit for Reflective Fiber Units
E39-F3C

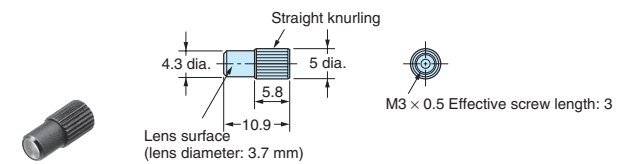

Material: Aluminum for body and optical glass, for the lens.

Note: This is the Lens Unit for the E32-C31 and E32-C41.

Precautions

Precautions for Correct Use

■ Fiber Units Mounting

Tightening Force

The tightening force applied to the Fiber Unit should be as follows:

Screw-mounting Model

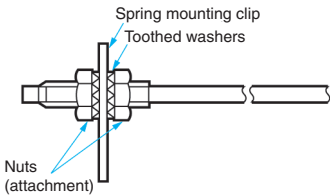

Cylindrical Model

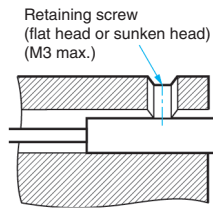

Fiber Units	Clamping torque
M6 screw/6-mm dia. cylinder	0.98 N·m max.
M3/M4 screw	0.78 N·m max.
2-mm dia./3-mm dia. cylinder	0.29 N·m max.
1.5-mm dia./1-mm dia. cylinder	0.2 N·m max.
E32-T12F 5-mm dia. fluororesin model	0.78 N·m max.
E32-D12F 6-mm dia. fluororesin model	
E32-L25A	
E32-M21	Up to 5 mm to the tip: 0.49 N·m max. More than 5 mm from the tip: 0.78 N·m max.
E32-T16	0.49 N·m max.
E32-R21	0.39 N·m max.
E32-T16W(R) E32-T16P(R) E32-T16J(R) E32-L24S E32-L24L E32-T25L	0.29 N·m max.

Use a proper-sized wrench.



Fiber Cutting Procedure

Cut a thin fiber as follows:

①	An attachment is temporarily fitted to a thin fiber before shipment.	
②	Secure the attachment after adjusting the position of it in the direction indicated by the arrow.	
③	Insert the fiber to be cut into the E39-F4.	
④	Finished state (proper cutting state)	

Note: Insert the fiber in the direction indicated by arrow.

Connection

- Do not pull or press the Fiber Units. The Fiber Units have a withstand force of 9.8 N or 29.4 N maximum.
- Do not bend the Fiber Unit beyond the permissible bending radius given under *Ordering Information*.
- Do not bend the edge of the Fiber Units (excluding the E32-T□R and E32-D□R).

Correct

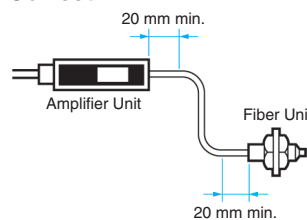

Incorrect

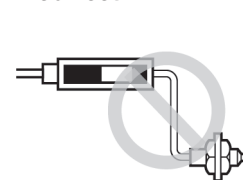

- Do not apply excess force on the Fiber Units.

Correct

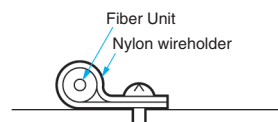

Incorrect

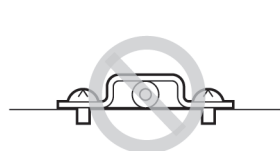

The Fiber Head could be broken by excessive vibration. To prevent this, the following is effective:

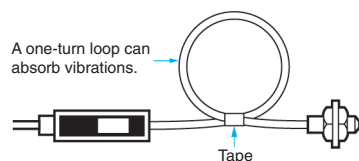

E39-F11 Sleeve Bender

- The bending radius of the stainless steel tube should be as large as possible. The smaller the bending radius becomes, the shorter the sensing distance will be.
- Insert the tip of the stainless steel tube to the Sleeve Bender and bend the stainless steel tube slowly along the curve of the Sleeve Bender (refer to the figure).

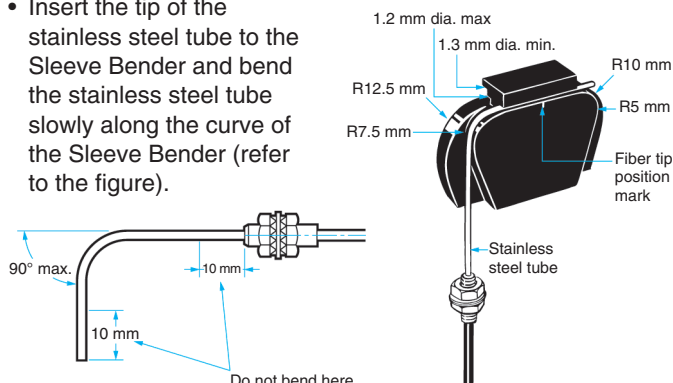

Heat-resistant Fiber Units (E32-D51 and E32-T51)

- The fibers of these Units cannot be extended using the E39-F10 Fiber Connector.
- The maximum allowable temperature for continuous operation with these Units is 130°C. It is 150°C for short-term use.

E32-T14 and E32-G14

These Units may enter the light-ON state if there are reflecting objects at the ends of the lenses. In this case, attach the black stickers provided to the ends of the lenses.

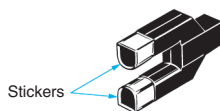

Wafer Sensors (E32-L25(A))

- To ensure correct performance, insert the fiber with a white line into the emitter-side port of the Amplifier Unit.

E32-T16 and E32-T16P

Example

E32-T16's sensing head

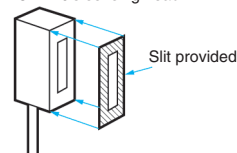

To use the slit provided, peel off the backing sheet, align it with the edges of the sensing surface, and attach it to the sensing head. Use the slit in applications where saturation occurs (i.e., changes in light intensity cannot be obtained) due to short sensing distances.

E32-M21

Separate the 4 fibers by distances sufficient to prevent interference.

Vacuum-resistant Fiber Units (E32-V)

Although Flanges, Fiber Units on the vacuum side, and Lens Units have been cleaned, as an extra precaution, clean these products with alcohol before use in high-vacuum environments to ensure that they are properly degreased.

Liquid-level Detection Sensors (E32-D82F)

- Secure the Fiber Unit using the unbendable section. Otherwise, the liquid-level detection position may be displaced.
- For applications in hazardous environments, install the Fiber Unit in the hazardous environment but install the Amplifier Unit in a safe environment.

Liquid-level Detection Sensors: Tube-mounting Models

- Ensure that the tube is not deformed when using a band to secure the Fiber Unit.
- Drops of water, bubbles, or haze inside the tube may cause malfunctions.

Adjustment E32-G14

The sensing distance is short, making the incident light intensity large. This makes it impossible to teach without a workpiece. Perform teaching with and without a workpiece.

Liquid-level (E32-D82F) Detection Position

The liquid-level detection position is at a distance of 5.2 ± 2 mm from the end of the fluororesin section. (Refer to the diagram on the right.)

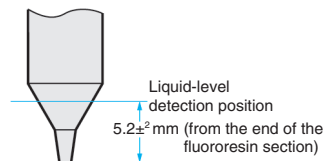

The liquid-level detection position varies with the surface tension of the liquid and the degree of wetness at the Fiber Unit's detection position.

Other Considerations

Liquid Level (E32-D82F)

- Operation may become unstable in the following cases:
 - ① Bubbles stick to the cone of the sensing head.
 - ② Solute is deposited on the cone of the sensing head.
 - ③ The liquid has a high viscosity.
- There are some liquids, such as milky white liquids, for which detection is not possible.
- Do not let the end of the fluororesin section bump into another object. Damage to, or deformation of, the sensing head may result in unstable operation.

Heat-resistant Fiber Units (E32-D81R, E32-D61, and E32-D73)

The pitch of the emission-side and reception-side fiber-insertion ports varies with the Amplifier Unit. Be sure to use an appropriate Fiber Unit.

Amplifier Unit	Fiber Unit
E3X-DA□-S E3X-MDA□	E32-D□-S
E3X-DA□-N E3X-NA□	E32-D□

Precautions

■ Accessories

Use of E39-R3 Reflector

1. Use detergent, etc., to remove any dust or oil from the surfaces where tape is applied. Adhesive tape will not be attached properly if oil or dust remains on the surface.
2. The E39-R3 cannot be used in places where it is exposed to oil or chemicals.

E39-F32□ Protective Spiral Tubes

1. Insert a fiber to the Protective Spiral Tube from the head connector side (screwed) of the tube.

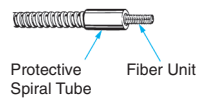

2. Push the fiber into the Protective Spiral Tube. The tube should be straight so that the fiber is not twisted when inserted. Then turn the end cap of the spiral tube.

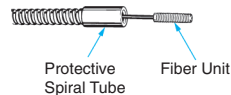

3. Secure the Protective Spiral Tube on a suitable place with the attached nut.

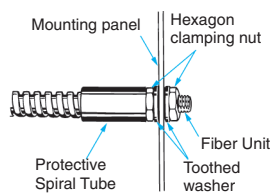

4. Use the attached saddle to secure the end cap of the Protective Spiral Tube. To secure the Protective Spiral Tube at a position other than the end cap, apply tape to the tube so that the portion becomes thicker in diameter.

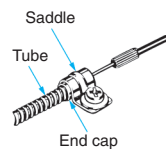

E39-F10 Fiber Connector

Mount the Fiber Connector as shown in the following illustrations.

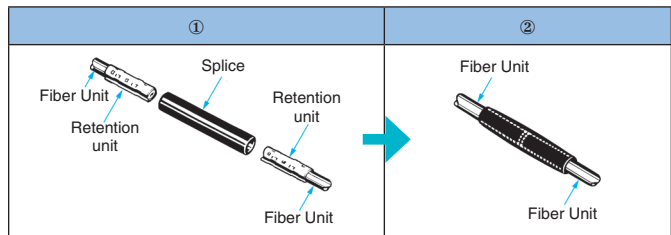

- The Fiber Units should be as close as possible when they are connected. Sensing distance will be reduced by approximately 25% when fibers are connected.
- Only 2.2-mm dia. fibers can be connected.

Simple Fiber Optic Amplifiers

E3X-SD with Digital Display, E3X-NA with Bar Graph Display

E3X-SD Features

- Streamlined features provide basic sensing immediately after plug-in
- Easy push button teach with or without workpiece
- Large, 6 mm wide digital display provides read-out of incident and operating level
- Incident settings and management can be performed reliably with 0 to 999% (10 times) fine tune adjustment
- Built-in OFF-delay, ON-delay, one-shot timer
- Optical communication design prevents mutual interference for up to 5 amplifiers
- Pre-wired (2 m cable) and wire-saving connector models available





E3X-NA Features

- Streamlined features provide basic sensing immediately after plug-in
- Use the LED bar display to quickly confirm sensor performance
- Optical communication design prevents mutual interference for up to 5 amplifiers
- Green LED models address mark-detecting applications
- High-speed models have a response time of 50 micro-seconds (μ s)
- IP66 Water-resistant models available with M8 connector or pre-wired with 2 m cable





Ordering Information

Amplifier Units

Digital Display and Direct Key Setting

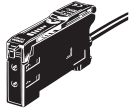
Item	Appearance	Connection method	Ratings and Specifications	Model	
				NPN output	PNP output
Standard models		Pre-wired	—	E3X-SD11	E3X-SD41
		Wire-saving connector		E3X-SD6	E3X-SD8

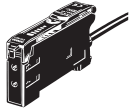
Bar Display and Adjuster Setting

Item	Appearance	Connection method	Ratings and Specifications	Model	
				NPN output	PNP output
Standard models		Pre-wired	—	E3X-NA11	E3X-NA41
		Wire-saving connector		E3X-NA6	E3X-NA8
High-speed detection models		Pre-wired	Response time: 20 μs	E3X-NA11F	E3X-NA41F
Water-resistant		Pre-wired	Degree of protection: IP66	E3X-NA11V	E3X-NA41V
		Connector (MB)		E3X-NA14V	E3X-NA44V

■ Specifications

Item	Type	Digital display and direct key setting	Bar display and adjuster setting		
	Model	Standard models	Standard models	High-speed detection models	Water-resistant models
		EX-SD□	E3X-NA□	E3X-NA□F	E3X-NA□V
Light source (wavelength)		Red LED (620 nm)	Red LED (680 nm)		
Power supply voltage		12 to 24 VDC ±10%, ripple (p-p): 10% max.			
Current consumption		960 mW max. (Power supply: 24 V, Current consumption: 40mA max.)	35 mA max.		
Control output		Open-collector output (NPN or PNP) Load power supply: 26.4 V max., Load current: 50 mA max. (Residual voltage: 1.5 V max.) (*1) Light-ON/Dark-ON mode selector			
Protection circuits		Power supply reverse polarity protection, output short-circuit protection, output reverse polarity protection (*2)			
Timer function		ON/OFF-delay timer: 10 ms (each fixed)	OFF-delay timer: 40 ms (fixed)		
Mutual interference prevention		Up to 5 Amplifiers (optically synchronized)	None	Up to 5 Amplifiers (optically synchronized)	
Weight (packed state)		Pre-wired model: Approx. 100 g, Model with connector: Approx. 55 g (*3)			

Note: *1. For the E3X-NA, residual voltage is 1V max.

*2. The E3X-NA does not have output reverse polarity prevention.

*3. Add 10 g for water-resistant models.

E3X-DA-S Dual Display Digital Fiber Optic Amplifier

Features

- Dual digital display can monitor current and preset values, including digital, bar, percent and hold display functions
- Power tuning function addresses saturation or insufficient light conditions
- 4-element LED and Auto Power Control ensure stable, long term performance
- Three inspection speeds/distances in one model: standard, high-speed and high-resolution
- Advanced functions include differential operation for minute object detection, 2 independent outputs for area detection, remote input function and counter function
- Advanced models available for Mark Detection; Two-Outputs for Area output, self-diagnostics or differential operation; external input for remote setting
- Optical communications ports built into each sensor enables data exchange with one another and the Omron Mobile Console remote control
- Pre-wired (2 m cable) and wire-saving connector models available

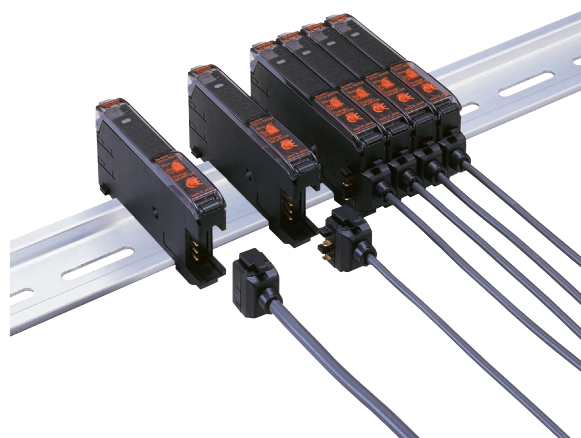

Ordering Information

Amplifier Units with Cables

Item		Appearance	Functions	Model	
				NPN output	PNP output
Standard models			—	E3X-DA11-S	E3X-DA41-S
Mark-detecting models	Green LED		—	E3X-DAG11-S	E3X-DAG41-S
	Blue LED		—	E3X-DAB11-S	E3X-DAB41-S
Advanced models	Two-output models		Area output, self-diagnosis, differential operation	E3X-DA11TW-S	E3X-DA41TW-S
	External-input models		Remote setting, counter, differential operation	E3X-DA11RM-S	E3X-DA41RM-S

Amplifier Units with Connectors

Item		Appearance	Functions	Model	
				NPN output	PNP output
Standard models			—	E3X-DA6-S	E3X-DA8-S
Mark-detecting models	Green LED		—	E3X-DAG6-S	E3X-DAG8-S
	Blue LED		—	E3X-DAB6-S	E3X-DAB8-S
Advanced models	Two-output models		Area output, self-diagnosis, differential operation	E3X-DA6TW-S	E3X-DA8TW-S
	External-input models		Remote setting, counter, differential operation	E3X-DA6RM-S	E3X-DA8RM-S

■ Specifications

Item	Type		Standard models	Mark-detecting models		Advanced, two-output models	Advanced, external-input models
	Model	NPN output	E3X-DA11-S	E3X-DAG11-S	E3X-DAB11-S	E3X-DA11TW-S	E3X-DA11RM-S
		PNP output	E3X-DA41-S	E3X-DAG41-S	E3X-DAB41-S	E3X-DA41TW-S	E3X-DA41RM-S
Light source (wavelength)			Red LED (650 nm)	Green LED (525 nm)	Blue LED (470 nm)	Red LED (650 nm)	
Supply voltage			12 to 24 VDC ±10%, ripple (p-p) 10% max.				
Power consumption			960 mW max. (current consumption: 40 mA max. at power supply voltage of 24 VDC)			1,080 mW max. (current consumption: 45 mA max. at power supply voltage of 24 VDC)	
Control output			Load power supply voltage: 26.4 VDC; NPN/PNP open collector; load current: 50 mA max.; residual voltage: 1 V max.				
Circuit protection			Reverse polarity for power supply connection, output short-circuit				
Response time	High-speed mode	NPN	48 μs for operation and 50 μs for reset			80 μs for operation and reset respectively	48 μs for operation and 50 μs for reset (*1)
		PNP	53 μs for operation and 55 μs for reset				53 μs for operation and 55 μs for reset (*1)
	Standard mode		1 ms for operation and reset respectively				
	High-resolution mode		4 ms for operation and reset respectively				
Functions	Power tuning		Light emission power and reception gain, digital control method				
	Differential detection		—			Switchable between single edge and double edge detection mode Single edge: Can be set to 250 μs, 500 μs, 1 ms, 10 ms, or 100 ms. Double edge: Can be set to 500 μs, 1 ms, 2 ms, or 200 ms.	
	Timer function		Select from OFF-delay, or one-shot timer. 1 ms to 5 s (1 to 20 ms set in 1-ms increments, 20 to 200 ms set in 10-ms increments, 200 ms to 1 s set in 100-ms increments, and 1 to 5 s set in 1 s-increments)				
	Automatic power control (APC)		High-speed control method for emission current				
	Zero-reset		Display can be reset to zero when required (negative values can be displayed).				
	Initial reset		Settings can be returned to defaults as required.				
	Mutual interference prevention		Possible for up to 10 Units. (*2, *3)				
	Counter		—			Switchable between up counter and down counter. Set count: 0 to 9,999,999	
I/O settings		—			Output setting (Select from channel 2 out-put, area output, or self-diagnosis.) External input setting (Select from teaching, power tuning, zero reset, light OFF, or counter reset.)		
Weight (packed state)			Approx. 100 g				

Note: *1. When counter is enabled: 80 μs for operation and reset respectively.

*2. Communications are disabled if the detection mode is selected during high-speed mode; the communications functions for mutual interference prevention and the Mobile Console will not function.

*3. Mutual interference prevention can be used for up to 6 Units if power tuning is enabled.

E3X-MDA Two-channel Dual Display Digital Amplifier



Features

- Two independent fiber-optic amplifiers in a slim, 10 mm wide track-mount unit
- Designed for gang mounting up to 18 sensors (9 units)
- Dual digital display can monitor current and preset values, including digital, bar, percent and hold display functions
- Three inspection speeds/distances in one model: standard, high-speed and high-resolution
- Logical AND/OR control output for local control in high-speed applications
- 4-element LED and Auto Power Control ensure stable, long term performance
- Optical communications ports built into each sensor enables data exchange with one another and the Omron Mobile Console remote control
- Pre-wired (2 m cable) and wire-saving connector models available



Ordering Information

Dual Amplifiers

Sensing heads	Setup	Features	Light source	Connection method	Model	
					NPN output	PNP output
Order E32 fiber-optic cables separately		And/OR logic output 3 sensing speeds	Red (650 nm)	Pre-wired	E3X-MDA11	E3X-MDA41
		One master connector for ganged units		Connector	E3X-MDA6	E3X-MDA8

■ Specifications

Item	Model	Type	2-channel models	
		NPN output	E3X-MDA11	E3X-MDA6
		PNP output	E3X-MDA41	E3X-MDA8
Light source (wavelength)		Red LED (650 nm)		
Supply voltage		12 to 24 VDC \pm 10%, ripple (p-p) 10% max.		
Power consumption		1,080 mW max. (current consumption: 45 mA max. at power supply voltage of 24 VDC)		
Control output		Load power supply voltage: 26.4 VDC; NPN/PNP open collector; load current: 50 mA max.; residual voltage: 1 V max.		
Circuit protection		Reverse polarity for power supply connection, output short-circuit		
Response time	High-speed mode	NPN	130 μ s (*1) for operation and reset respectively	
		PNP		
	Standard mode	1 ms for operation and reset respectively		
	High-resolution mode		4 ms for operation and reset respectively	
Functions	Power tuning		Light emission power and reception gain, digital control method	
	Timer function		Select from OFF-delay, or ON-delay, one-shot timer. 1 ms to 5 s (1 to 20 ms set in 1-ms increments, 20 to 200 ms set in 10-ms increments, 200 ms to 1 s set in 100-ms increments, and 1 to 5 s set in 1 s-increments)	
	Automatic power control (APC)		High-speed control method for emission current	
	Zero-reset		Display can be reset to zero when required (negative values can be displayed).	
	Initial reset		Settings can be returned to defaults as required.	
	Mutual interference prevention		Possible for up to 9 Units (18 channels) (*2, *3)	
I/O settings		Output setting (Select from channel 2 output, AND, OR, leading edge sync, falling edge sync, or differential output)		
Weight (packed state)		Approx. 100 g		Approx. 55 g

Note: *1. When differential output is selected for the output setting, the second channel output is 200 μ s for the operation and reset respectively.

*2. Communications are disabled if the detection mode is selected during high-speed mode; the communications functions for mutual interference prevention and the Mobile Console will not function.

*3. Mutual interference prevention can be used for up to 5 Units (10 channels) if power tuning is enabled.

E3X-DAC-S True Color Fiber Optic Amplifiers with Digital Dual Display

Features

- Reliability through precise and true color detection with White LED emitter and RGB (Red, Green and Blue) processing
- Enhanced stability: workpiece movement does not affect the sensor as the receiver element processes light as a ratio to compensate for intensity variations
- Easy push button setup guides the user to place the workpiece in an appropriate position for teaching
- Full-functional, dual digital display can monitor current preset values, including digital, bar, percent and hold display functions
- On-Board timing function incorporating OFF-delay, On-delay, and one-shot timing functions
- Advanced models offer remote control as well as twin sensing and output to simultaneously distinguish between two registered colors
- Pre-wired (2 m cable) and wire-saving connector models available

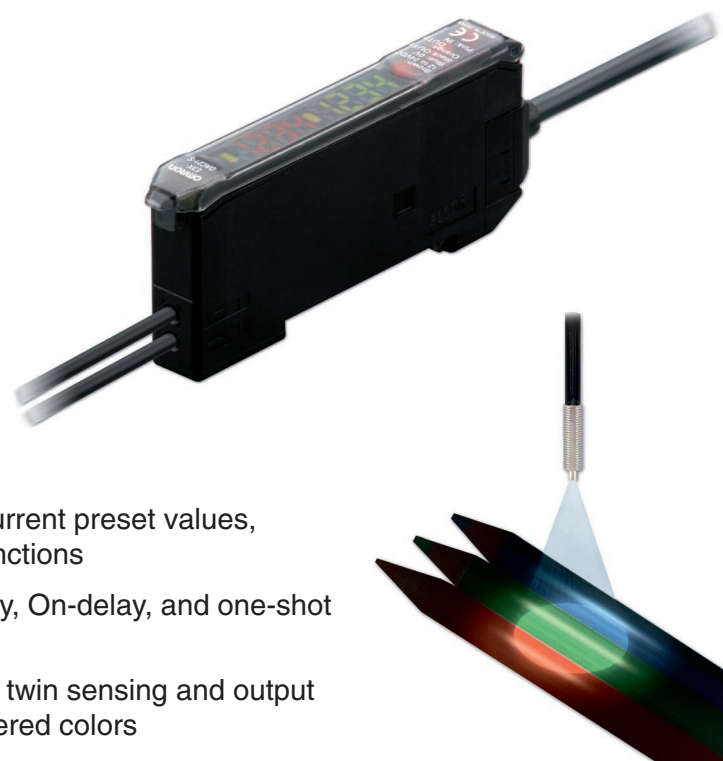

■ Ordering Information

Amplifier Units

Amplifier Units with Cables

Item	Appearance	Functions	Model	
			NPN output	PNP output
Standard models		Timer, Response speed change	E3X-DAC11-S	E3X-DAC41-S
Advanced models		Standard models + Simultaneous determination (2 colors) AND/OR output, Remote setting	E3X-DAC21-S	E3X-DAC51-S

Amplifier Units with Connectors (Amplifier Unit Connectors must be purchased separately.)

Item	Appearance	Functions	Model	
			NPN output	PNP output
Standard models		Timer, Response speed change	E3X-DAC6-S	E3X-DAC8-S

■ Specifications

Item	Type	Standard models	Advanced models
	Model	E3X-DAC□-S□ (□: 11/41/6/8)	E3X-DAC□-S□ (□: 21/51)
Light source (wavelength)	White LED (420 to 700 nm)		
Sensing method	C Mode: RGB ratio determination (or I Mode: Light intensity determination for red, green, or blue) (*1)		
	Number of registered colors	1	2 (simultaneous determination)
Power supply voltage	12 to 24 VDC ±10%, ripple (p-p) 10% max.		
Power consumption	960 mW max. (current consumption: 40 mA max. at power supply voltage of 24 VDC)		
Control output	NPN or PNP open collector Load power supply voltage: 26.4 VDC max. load current: 50 mA max. (residual voltage: 2 V max.)		
Remote control input	—	No-voltage input (contact/transistor)	
Protection circuits	Reverse polarity for power supply connection, output short-circuit, Reversed output polarity protection		
Response time	Super-high-speed mode (*2)	Operate or reset: 60 μs	Operate or reset: 120 μs
	High-speed mode	Operate or reset: 300 μs	Operate or reset: 600 μs
	Standard mode	Operate or reset: 1 ms	Operate or reset: 2 ms
	High-resolution mode	Operate or reset: 4 ms	Operate or reset: 8 ms
Functions	Operating mode	ON for match (ON for same color as registered color) or ON for mismatched (ON for different color from registered color)	
	Timer function	Timer type: OFF delay, ON delay, or one-short Timer range: 1 ms to 5 s (variable)	
	Control outputs	—	Output for each channel, AND output, and OR output
	Remote control	—	One-point teaching, teaching with/without workpiece, zero reset, and light emission OFF
	Display switch (*3)	Seven patterns total: Match + Threshold + Margin + Threshold, Analog bar display, Peak + Bottom, etc.	
	Initialization	Initial reset (factory defaults) or user reset (saved settings)	
Weight (packed state)	Pre-wired model: Approx. 100g, Amplifier unit connector model: Approx. 55 g		

Note: *1. When teaching with/without a workpiece, the best sensing method will be automatically selected (RGB ratio (C Mode) or light intensity determination (I Mode)).

If color differences are not strong enough and RGB ratios would result in unstable detection, then light intensity determination (I Mode) will be selected.

*2. Mutual interference prevention cannot be used in super-high-speed mode, and light intensity determination (I Mode) must be used.

*3. With light intensity determination (I Mode), the correlation is not displayed, but rather the light intensity is displayed.

E3C-LD/-LR Laser Optics Sensing Heads for Measurement

- Area, spot and line beam sensing heads offer variable focal point and optical axis alignment
- Safe Class I lasers require no special protective hardware
- Use with E3C-LDA, slim track-mount digital amplifiers (see page 82)



■ Applications

Adhesive and Seal Application Inspection

Minute objects

Confirming seal extraction

Reduced defects
Improved product quality

Grease Application Inspection

Area detection for minute objects

Confirming grease application amounts for moving parts

Improved product quality

Sheet Displacement Inspection

Edge white/black deviations

Confirming marks on sheets

Confirming sheet displacement before printing

Reduced defects
Improved operating rate

Noodle Protrusion Inspection

Inspect before packaging

Area detection

Line beam

Misalignment

Reduced defects

Repeated Robot Arm Positioning Teaching for Calibration

Positioning

Improved product quality

Inspection for Fine Pins

Confirming guide pin movement

Minute objects

Reduced defects
Improved operating rate

■ Sensing Head Options

Sensing method	Beam shape	Sensing distance	Dimensions H x W x D mm	Model
Diffuse reflective	Spot, 0.8 mm max.	30 mm to 1 m	25 x 12.8 x 33	E3C-LD11
	Line, 33 mm L	30 mm to 1 m	27 x 13.2 x 36	E3C-LD21
	Area, 33 x 15 mm	30 mm to 1 m	27 x 13.2 x 36	E3C-LD31
Coaxial retroflective with mirror surface rejection	Variable spot (0.8 mm dia.)	Up to 7 m with E39-R12	25 x 12.8 x 39	E3C-LR11
	Line, 28 mm L	Up to 1.7 m with E39-R12	25 x 12.8 x 39	E3C-LR11 + E39-P31
	Area, 28 x 16 mm	Up to 900 mm with E39-R12	25 x 12.8 x 39	E3C-LR11 + E39-P41
	Fixed spot (2 mm dia.)	Up to 7 m with E39-R12	25 x 12.8 x 39	E3C-LR12

E3C-LDA Dual Display Digital Amplifier for Laser Optics

Features

- Dual digital display simplifies setup and monitoring
- Selectable detection modes with response speed as fast as 100 μs
- One-touch sensitivity setting with Power Tuning function compensates for saturation
- Provides analog voltage and discrete outputs for position control, height measurement and other gauging applications
- Dual output models available offering area output, differential operation and self-diagnostics
- External input models offer remote setting, built-in counter and differential operation



Ordering Information

Pre-Wired Amplifiers

Type	Functions	Output type	Output ratings	Model	
				NPN output	PNP output
Analog + Discrete outputs	Area output, differential operation	Analog, discrete	1 to 5 VDC, 50 mA at 26.4 VDC	E3C-LDA11AN	E3C-LDA41AN
Dual discrete outputs	Area output, differential operation, self-diagnostics	Two open collector	50 mA at 26.4 VDC	E3C-LDA11	E3C-LDA41
External input + Discrete output	Built-in counter, differential operations, remote setting	One open collector	50 mA at 26.4 VDC	E3C-LDA21	E3C-LDA51

Amplifiers with Wire-Saving Connectors

Type	Functions	Output type	Output ratings	Model	
				NPN output	PNP output
Dual discrete outputs	Area output, differential operation, self-diagnostics	Two open collector	50 mA at 26.4 VDC	E3C-LDA6	E3C-LDA8
External input + Discrete output	Built-in counter, differential operations, remote setting	One open collector	50 mA at 26.4 VDC	E3C-LDA7	E3C-LDA9

■ Specifications

Type	Diffuse-reflective			Coaxial Retro-reflective			
Model	E3C-LD11	E3C-LD21	E3C-LD31	E3C-LR11	E3C-LR11 + E39-P31	E3C-LR11 + E39-P41	E3C-LR12
Light source (emission wavelength)	Red semiconductor laser diode (650 nm), 3 mW max. (JIS standard: Class 2, FDA standard: Class II)			Red semiconductor laser diode (650nm), 2.5 mW max. (JIS standard: Class 2, FDA standard: Class II)			1 mW max. (JIS standard: Class 1)
Sensing distance	High-resolution mode: 30 to 1,000 mm Standard mode: 30 to 700 mm Super-high-speed mode: 30 to 250 mm (*1)			7 m 5 m 2 m (*2)	1,700 mm 1,300 mm 700 mm (*2)	900 mm 700 mm 400 mm (*2)	7 m 5 m 2 m (*2)
Focus (*3)	0.8 mm max. (at distances up to 300 mm)	33 mm (at 150 mm)	33 x 15 mm (at 150 mm)	0.8 mm max. (at distances up to 1,000 mm)	28 mm (at 150 mm)	28 x 16 mm (at 150 mm)	2.0 mm dia. (at distances up to 1,000 mm)
Functions	Variable focal point mechanism (focus adjustment) (*4), optical axis adjustment mechanism (axis adjustment)						
Indicators	LDON indicator: Green; Operation indicator: Orange						
Ambient illumination (receiver side)	Incandescent lamp: 3,000 lx						
Ambient temperature	Operating: -10 to 55°C, Storage: -25 to 70°C (with no icing or condensation)						
Ambient humidity	Operating/storage: 35% to 85% (with no condensation)						
Insulation resistance	20 MΩ min. at 500 VDC						
Dielectric strength	1,000 VAC at 50/60 Hz for 1 minute						
Shock resistance	Destruction: 300 m/s ² 6 directions 3 times each (up/down, right/left, forward/backward)						
Vibration resistance	Destruction: 10 to 150 Hz with double amplitude of 0.7 mm, in X, Y, and Z directions for 80 min each						
Degree of protection	IP40 (IEC 60529)			IP40 (IEC 60529)			
Connection method	Connector (standard cable length: 2 m)						
Materials	Case and cover: ABS Front surface filter: Methacrylic resin			Case and cover: ABS Front surface filter: Glass			
Weight (packed)	Approx. 85 g			Approx. 100 g			

Note: *1. Sensing distance values are for white paper.

*2. These sensing distance values apply when a E39-R12 Reflector is used. The MSR function is built-in. The reflected light from the object being measured may affect the sensing accuracy, so adjust the threshold value before use.

*3. The beam radius is the value for the middle measurement distance and indicates a typical value for the middle sensing distance. The radius is defined by light intensity of 1/e² (13.5%) of the central light intensity. Light will extend beyond the main beam and may be affected by conditions surrounding the object being measured.

*4. The E3C-LR12 has a fixed beam size (the focal point cannot be changed).

■ Specifications

Analog Output Amplifiers

Model		E3C-LDA11AN	E3C-LDA41AN
Supply voltage		12 to 24 VDC ±10%, ripple (p-p) 10% max.	
Power consumption		1080 mW max.	
Current consumption		45 mA max. at supply voltage of 24 VDC	
Analog output	Voltage output	1 to 5 VDC with connected load of 10kΩ min.	
Discrete output	Type	NPN open collector	PNP open collector
	Rating	50 mA at 26.4 VDC	
	Residual voltage	1 V max.	
Response time	Super high-speed mode	100 μs	
	High-speed mode	250 μs	
	Standard mode	1 ms	
	High resolution mode	4 ms	
Repeatability	Super high-speed mode	4% FS	
	High-speed mode	4% FS	
	Standard mode	2% FS	
	High resolution mode	2% FS	
Temperature influence		0.3% FS/°C	
Connection method		Pre-wired with 2 m cable	
Dimensions		32 H x 10 W x 78.5 D mm	

Discrete Output Amplifiers



Type	Advanced, twin-output models		Advanced, external-output models		
Model	NPN output	E3X-LDA11	E3X-LDA6	E3X-LDA21	E3X-LDA7
Item	PNP output	E3X-LDA41	E3X-LDA8	E3X-LDA51	E3X-LDA9
Supply voltage		12 to 24 DVC ±10%, ripple (p-p) 10% max.			
Power consumption		1,080 mW max. (current consumption: 45 mA max. at power supply voltage of 24 VDC)			
Response time	Super-high-speed mode	100 μs for operation and reset		80 μs for operation and reset	
	Standard mode	1 ms for operation and reset respectively			
	High-resolution mode	4 ms for operation and reset respectively			
Functions		Power turning, differential detection, timer, zero-reset, initial reset, mutual interference prevention (*1), preset counter (*2), reversed display			
I/O settings		Output setting (Select from channel 2 output, area output, or self-diagnosis.)		External input setting (Select from teaching, power tuning, zero reset, light OFF, or counter reset.)	
Weight (packed state)		Approx. 100 g	Approx. 55 g	Approx. 100 g	Approx. 55 g

Note: *1. Communications are disabled if super-high-speed mode is selected, and the mutual interference prevention function and the communications function for the Mobile Console will not function.





*2. The preset counter is available only with advanced, external-input models.

■ Accessories

Beam Unit

Applicable Sensor Head	Appearance	Beam Shape	Model
E3C-LD11		Line	E39-P11
		Area	E39-P21
E3C-LR11		Line	E39-P31
		Area	E39-P41

Reflectors

Type	Appearance	Model
Standard Effective area: 23 x 23 mm		E39-R12
Standard Effective area: 7 x 7 mm		E39-R13
Transparent object detection Effective area: 23 x 23 mm		E39-R14
Sheet (cuttable) Effective area: 195 x 22 mm		E39-RS4
Sheet (cuttable) Effective area: 108 x 46 mm		E39-RS5

■ Dimensions (Unit: mm)

Sensor Head

E3C-LD11

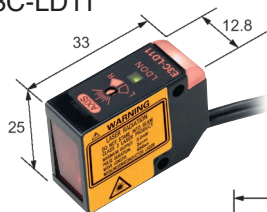

E3C-LR11
E3C-LR12

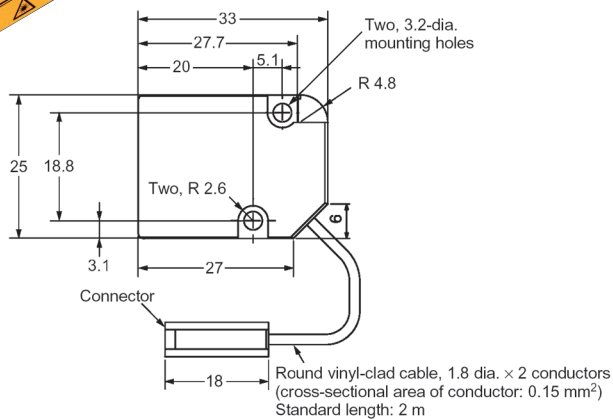
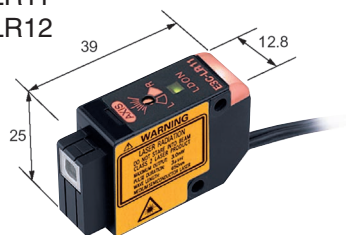

E3C-LD21
E3C-LD31

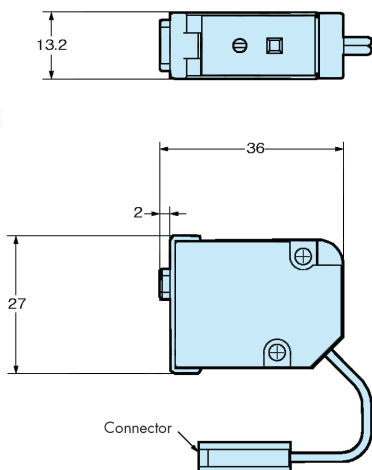

Reflector

E39-R12/-14

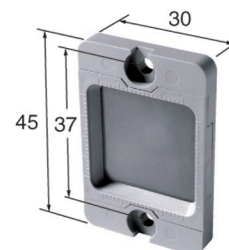

E39-R13

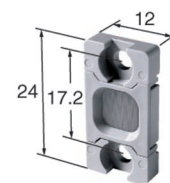

Wire-Saving Connector Models

- Streamlines installation and maintenance to reduce service time
- Unique connector design reduces wiring and space requirement because one master connector supplies power to all other slave connectors
- Detach the sensor without disturbing the fiber installation or output wiring for servicing

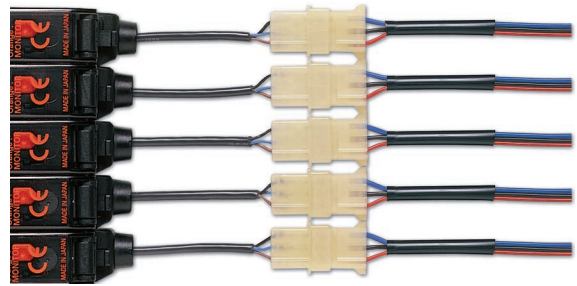

Pre-wired models
require three wiring connections for each sensor.
Shown: 15 wires plus extension connector wires.



The **E3X-DA-S** requires three wiring connections for the master sensor only. Each additional sensor in a group requires only one wiring connection.
Shown: ONLY 7 WIRES with no additional extension connectors.

Connectors



Description	Appearance	Compatible amplifiers	Cable length	Conductors	Model
Master connector (for first unit)		E3X-DA6-S, E3X-DA8-S, E3X-DAG6-S, E3X-DAG8-S, E3X-DAB6-S, E3X-DAB8-S, E3X-DAC6-S, E3X-DAC8-S, E3X-NA6, E3X-NA8, E3X-SD6, E3X-SD8	2 m	3	E3X-CN11
		E3X-DA6TW-S, E3X-DA8TW-S, E3X-DA6RM-S, E3X-DA8RM-S, E3X-MDA6, E3X-MDA8, E3C-LDA6, E3C-LDA7, E3C-LDA8, E3C-LDA9	2 m	4	E3X-CN21
Slave connector (for second and additional units)		E3X-DA6-S, E3X-DA8-S, E3X-DAG6-S, E3X-DAG8-S, E3X-DAB6-S, E3X-DAB8-S, E3X-DAC6-S, E3X-DAC8-S, E3X-NA6, E3X-NA8, E3X-SD6, E3X-SD8	2 m	1	E3X-CN12
		E3X-DA6TW-S, E3X-DA8TW-S, E3X-DA6RM-S, E3X-DA8RM-S, E3X-MDA6, E3X-MDA8, E3C-LDA6, E3C-LDA7, E3C-LDA8, E3C-LDA9	2 m	2	E3X-CN22

M8 Connectors

Use these connectors with water-resistant E3X-NA14V and E3X-NA44V amplifiers only.

Size	Cable specifications	Appearance	Cable type		Model
M8	Standard cable	Straight connector	2m	Four-conductor cable	XS3F-M421-402-A
			5m		XS3F-M421-405-A
		L-shaped connector	2m		XS3F-M422-402-A
			5m		XS3F-M422-405-A

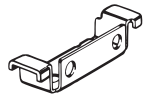
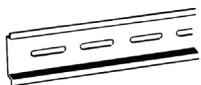

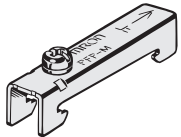

Mounting Bracket and Track

Description	Appearance	Dimensions H x W x D mm	Specification	Model
Surface mounting bracket		7.3 H x 35 W x 12 D	304 stainless steel; fits the DIN track holder	E39-L143
Mounting track		500 L x 35 H x 7.3 D	0.5 m length	PFP-50N
		1000 L x 35 H x 7.3 D	1 m length	PFP-100N
		1000 L x 35 H x 16.0 D	1 m length	PFP-100N2
End plate		50 x 10 x 10	Holds track-mounted devices in place	PFP-M

Mobile Console

- Program and monitor the following amplifiers remotely with mobile console: E3X-DA-S, E3X-MDA, E3C-LDA
- Console includes 1.5 m cable for remote setup connection to the programming head
- Programming head track mounts flush against leftmost amplifier
- AC adapter powers console



Description	Appearance/ Dimensions	Model
Mobile console kit Includes console, programming head, cable and AC adapter		E3X-MC11-SV2
Mobile console (only)	 136 H x 52.8 W x 22 D mm	E3X-MC11-C1-SV2
Programming head (only) Mounts on DIN rail	 51.3 H x 20 W x 30.3 D mm	E3X-MC11-H1
Cable	 1.5 m length	E3X-Z12-1

Fiber Optic or Laser Optic Sensor Communication Unit Supports Multi-vendor Networks

- ON/OFF signals and incident light levels can be sent to the host
- PLC without any need for programming (using the Remote I/O Communications Slave function).
- Threshold values and function settings can be read, written, or taught (using the Message Communications function).
- Device parameters prepared on a personal computer connected to the network can be downloaded in a batch operation (using the Configurator).

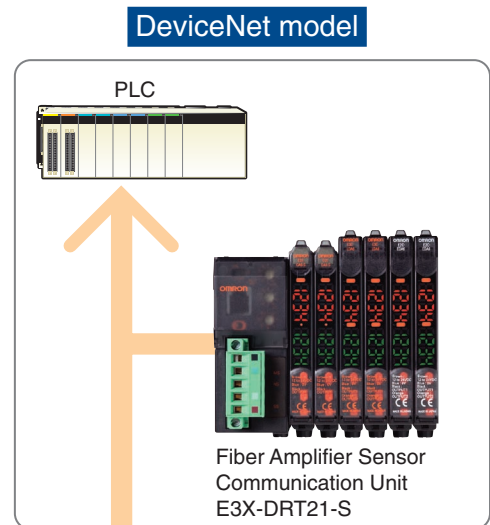

A Network That Expands Your World

Configurator
Download a group of parameters for devices (Sensors, Temperature Controllers, etc., supporting DeviceNet) that you have prepared on your personal computer in a single batch.

DeviceNet

PLC

Optical Communications

Mobile Console
A built-in interface for a Mobile Console lets you bring setting and confirmation operations to your fingertips.

Monitor operating hours.
The operating hours for sensors can be stored in internal memory and used for planning maintenance and other applications.

Supports a wide range of sensors.
The Unit supports a variety of digital sensors, including Fiber Sensors, Laser Sensors, and Proximity Sensors.

Up to 16 channels can be connected.

■ Ordering Information

Fiber Amplifier Sensor Communication Unit

Type	Model
DeviceNet	EX-DRT21-S

Wire-reducing Connector

Type	Model
Cordless Slave Connector	E3X-CN02

■ Ratings and Specifications

Item	Description	
Communications Methods	DeviceNet communications	
Communications functions	Remote I/O Communications Slave function	Monitors ON/OFF output, status, incident light level (digital display data)
	Message Communications functions	Sets parameters using Explicit messages
	Configurator	Edits slave devices parameters, enables device monitor functions
Mobile Console connection	E3X-MC11-S-V2 can be connected	
Power supply	Supplied from the DeviceNet communications connector(power is also supplied to all connected Sensors through Wire-reducing Connectors)	
Maximum connectable Sensors	13 or 16 (depending on the operation mode)	
Connectable Sensors	E3X-DA-S Series or E3X-MDA Series Digital Fiber Sensor E3C-LDA Series Laser Photoelectric Sensor with Separate Digital Amplifier E2C-EDA High-resolution Digital Proximity Sensor with Separate Amplifier (use connector-type Amplifier Units and the E3X-CN02 Cordless Slave Connector)	
Power supply voltage	11 to 25 VDC	
Current consumption (See note.)	70 mA max.	
Ambient operating temperature	-20 to 55°C	
Ambient operating humidity	35% to 85% (with no condensation)	
Storage temperature	-30 to 70°C	
Dimensions (mm)	30 x 34.6 x 71.3 (W x H x D)	
Weight (packed state)	Approx. 150 g	

Note: This does not include the current supplied to the Sensor.

Fiber Optic Amplifiers

Amplifier Units with Cables

- E3X-SD11
- E3X-SD41
- E3X-NA11
- E3X-NA11F
- E3X-NA41
- E3X-NA41F

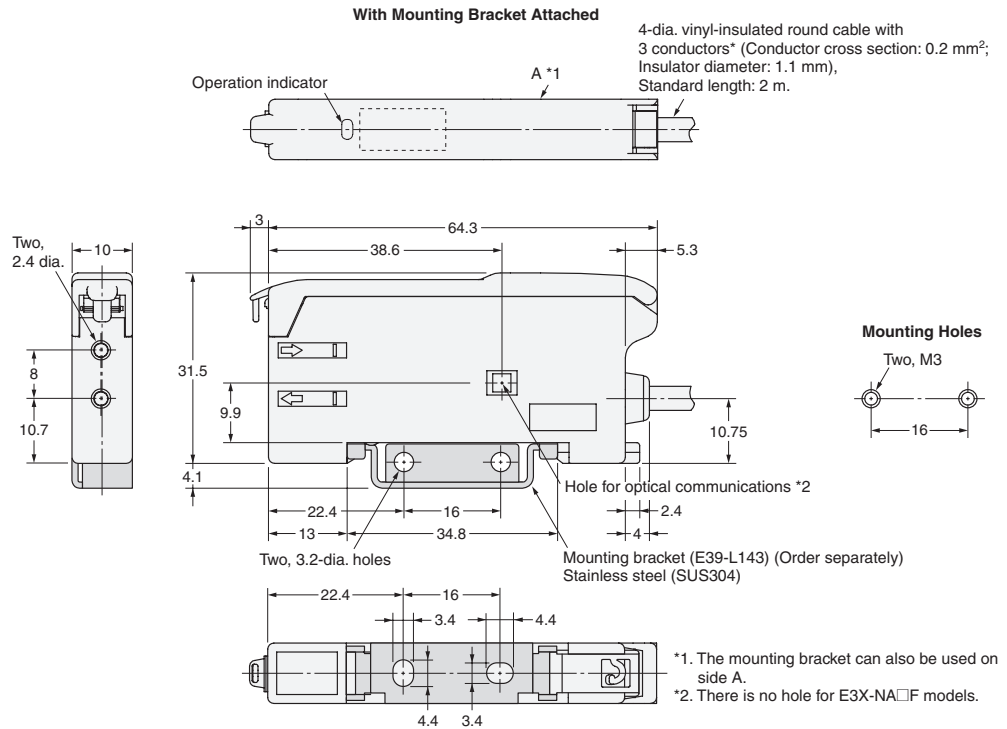

Amplifier Units with Connectors

- E3X-SD6
- E3X-SD8
- E3X-NA6
- E3X-NA8

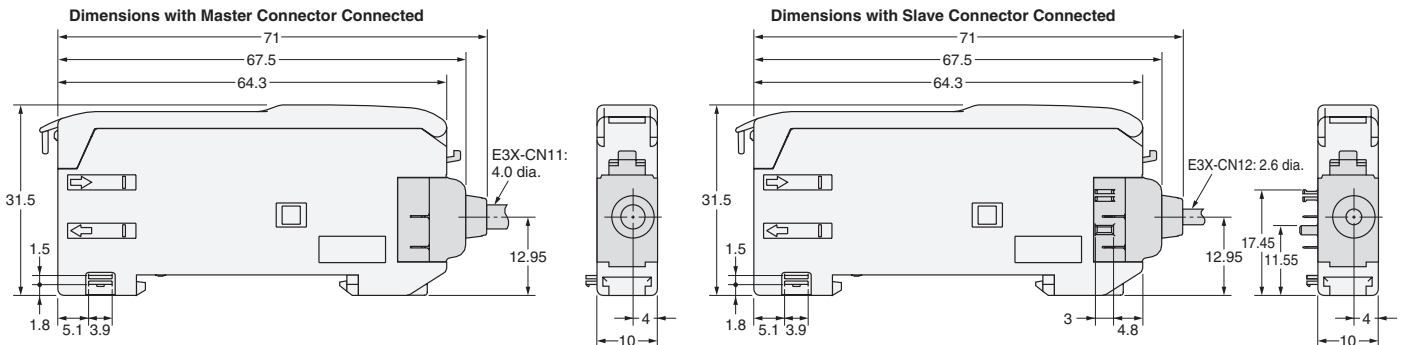
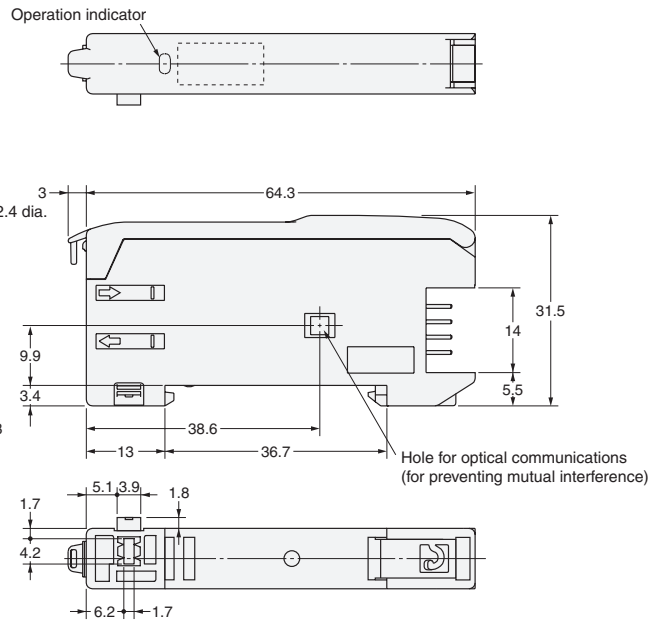

Amplifier Units with Cables,
Water-resistant Models
E3X-NA11V
E3X-NA41V

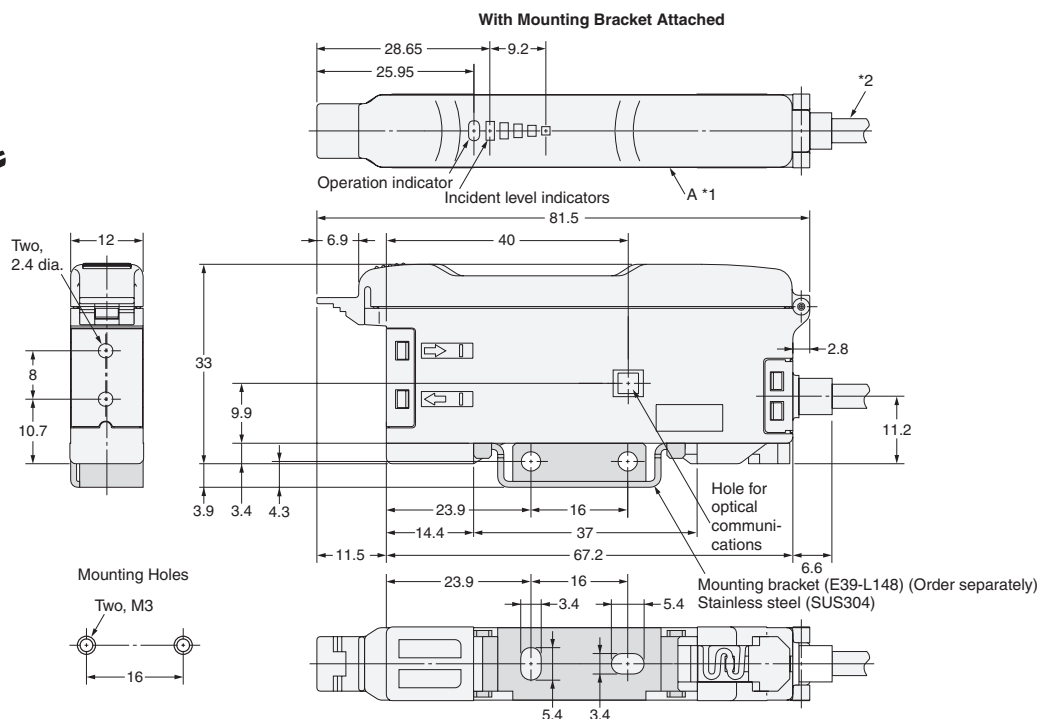
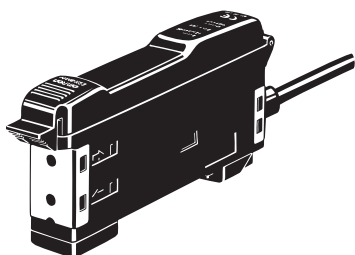

- *1. The mounting bracket can also be used on side A.
- *2. 4-dia. vinyl-insulated round cable with 3 conductors (Conductor cross section: 0.45 mm², Insulator diameter: 1.1 mm), Standard length: 2 m.

Amplifier Units with Connectors,
Water-resistant Models
E3X-NA14V
E3X-NA44V

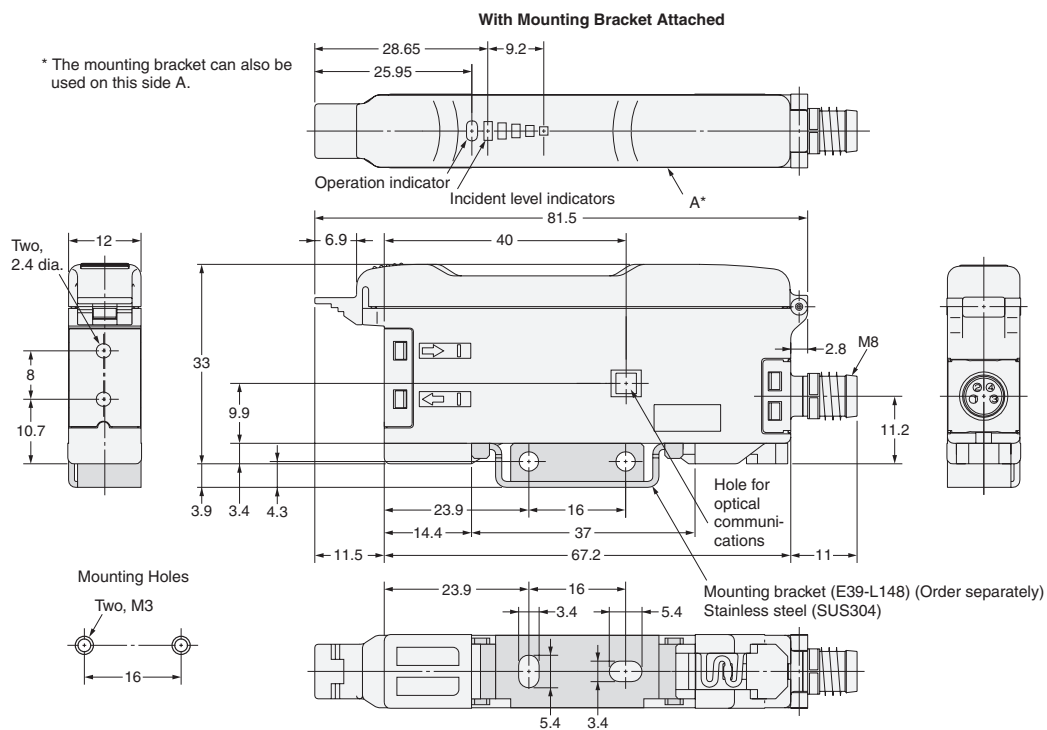
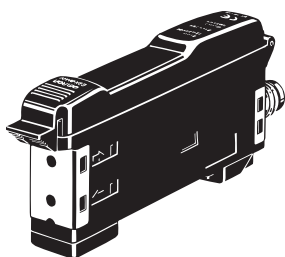

* The mounting bracket can also be used on this side A.

Dimensions (Unit: mm)

Amplifier Units with Cables

- E3X-DA11-S
- E3X-DA41-S
- E3X-DAC11-S
- E3X-DAC21-S
- E3X-DAC41-S
- E3X-DAC51-S
- E3X-DAG11-S
- E3X-DAG41-S
- E3X-DAB11-S
- E3X-DAB41-S
- E3X-DA11RM-S
- E3X-DA41RM-S
- E3X-DA11TW-S
- E3X-DA41TW-S
- E3X-MDA11
- E3X-MDA41

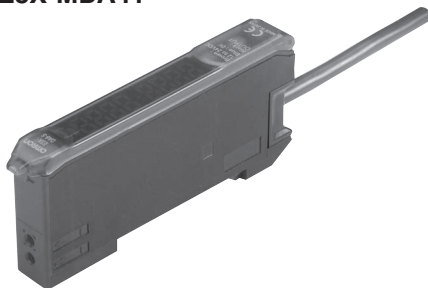
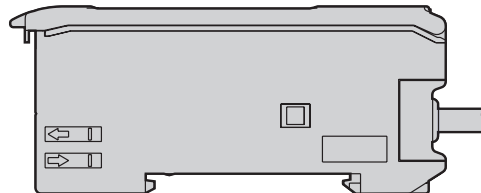
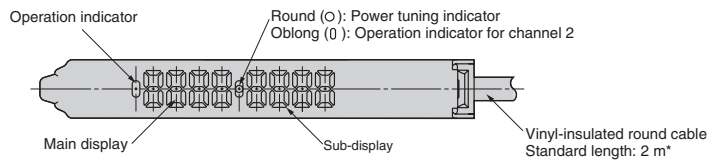

Cable Specifications

E3X-DA11-S/DA41-S/DAG11-S/ DAG41-S/DAB11-S/DAB41-S/ DAC11-S/DAC41-S	A 4-dia., 3-conductor (conductor cross-sectional area: 0.2 mm ² ; insulation diameter: 1.1 mm)
E3X-DA11TW-S/DA41TW-S/ DA11RM-S/DA41RM-S	A 4-dia., 4-conductor (conductor cross-sectional area: 0.2 mm ² ; insulation diameter: 1.1 mm)
E3X-MDA11/-MDA41	A 4-dia., 2-conductor (conductor cross-sectional area: 0.2 mm ² ; insulation diameter; 1.1 mm)
E3X-DAC21-S/-DAC51-S	A 4-dia., 5-conductor (conductor cross-sectional area: 0.2 mm ² ; insulation diameter; 1.1 mm)

With Mounting Bracket Attached

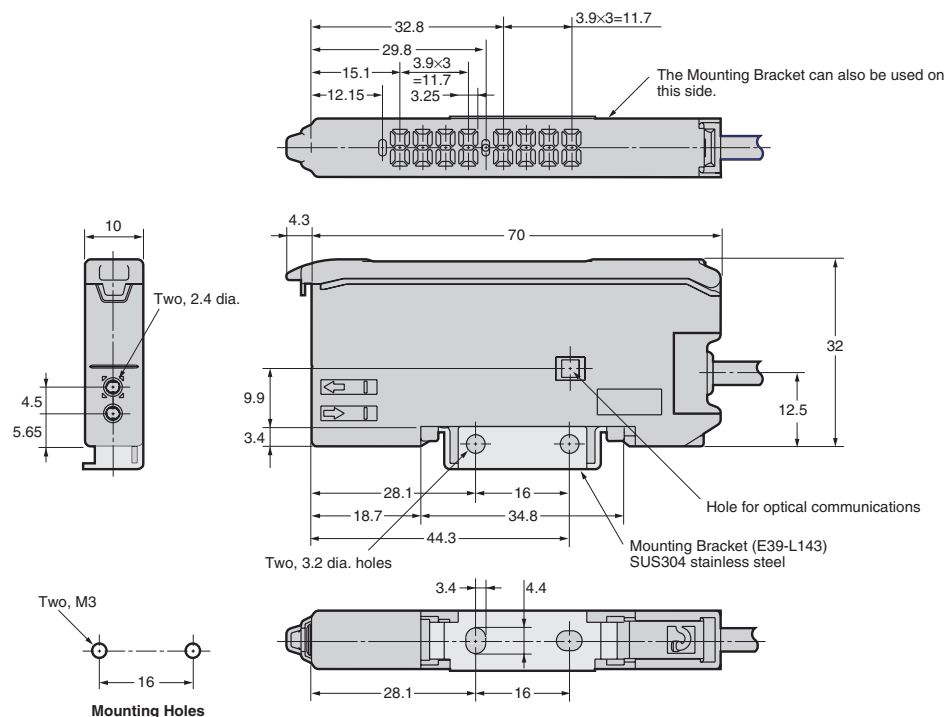

Amplifier Units with Connectors

- E3X-DA6-S
- E3X-DA8-S
- E3X-DAC6-S
- E3X-DAC8-S
- E3X-DAG6-S
- E3X-DAG8-S
- E3X-DAB6-S
- E3X-DAB8-S
- E3X-DA6RM-S
- E3X-DA8RM-S
- E3X-DA6TW-S
- E3X-DA8TW-S

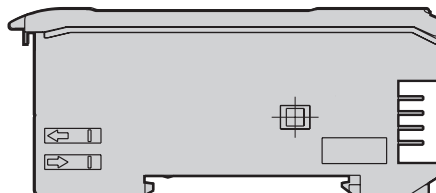
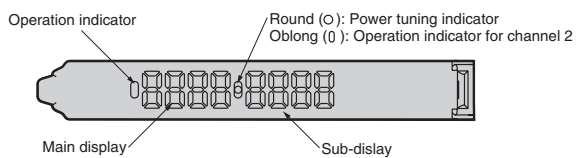

*1 The Mounting Bracket can also be used on this side.

*2 Cable Diameters

With Mounting Bracket Attached

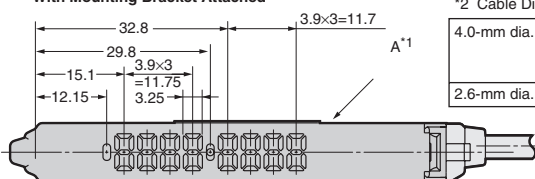

4.0-mm dia.	E3X-CN11 (3 conductors) E3X-CN21 (4 conductors) E3X-CN22 (2 conductors)
2.6-mm dia.	E3X-CN12 (1 conductor)

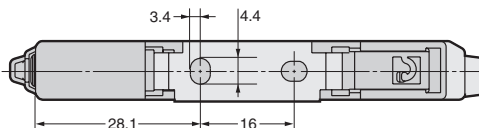
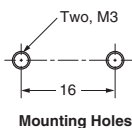
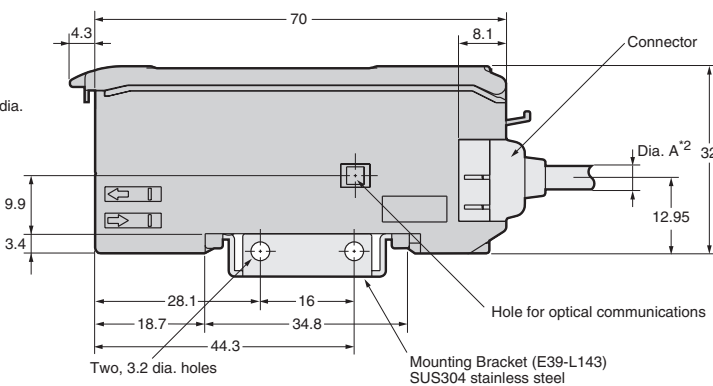
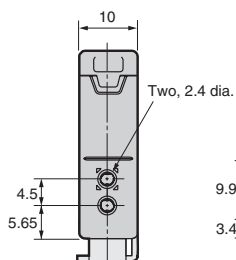

E3C-LDA Laser Optic Amplifiers

Pre-wired Models

- E3C-LDA11
- E3C-LDA21
- E3C-LDA41
- E3C-LDA51
- E3C-LDA11AN
- E3C-LDA41AN

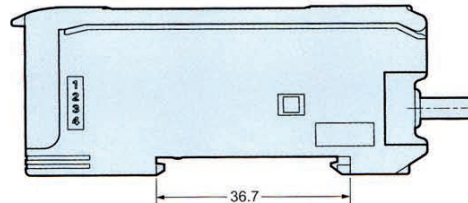
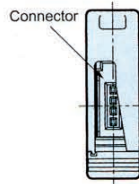
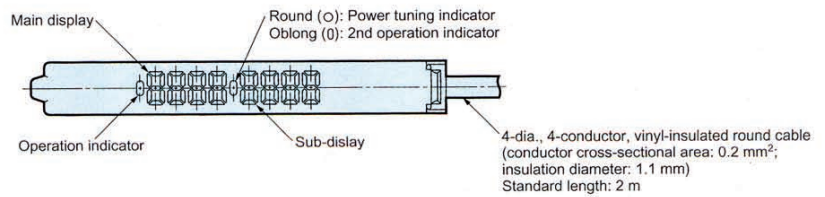

With Mounting Bracket Attached

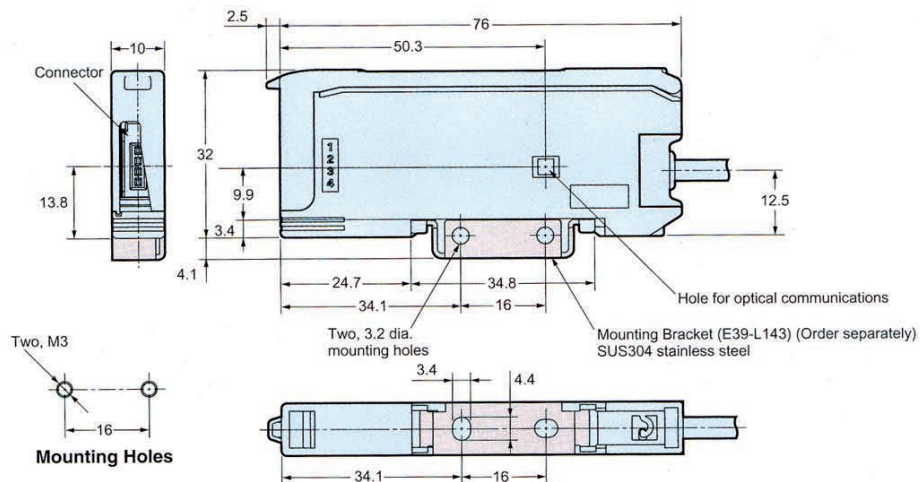
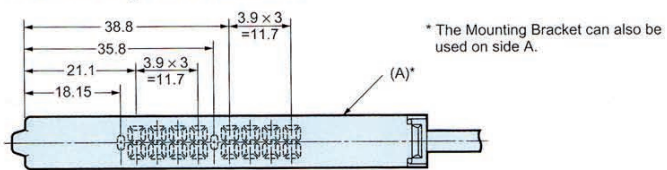

Amplifier Units with Connectors

- E3C-LDA6
- E3C-LDA7
- E3C-LDA8
- E3C-LDA9

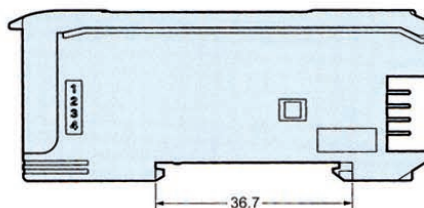
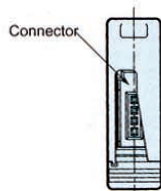
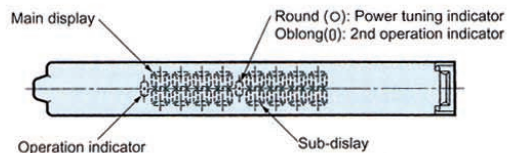

With Mounting Bracket Attached

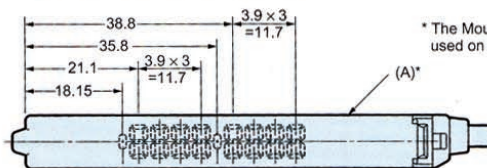

* The Mounting Bracket can also be used on side A.

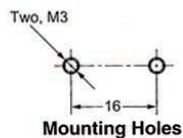
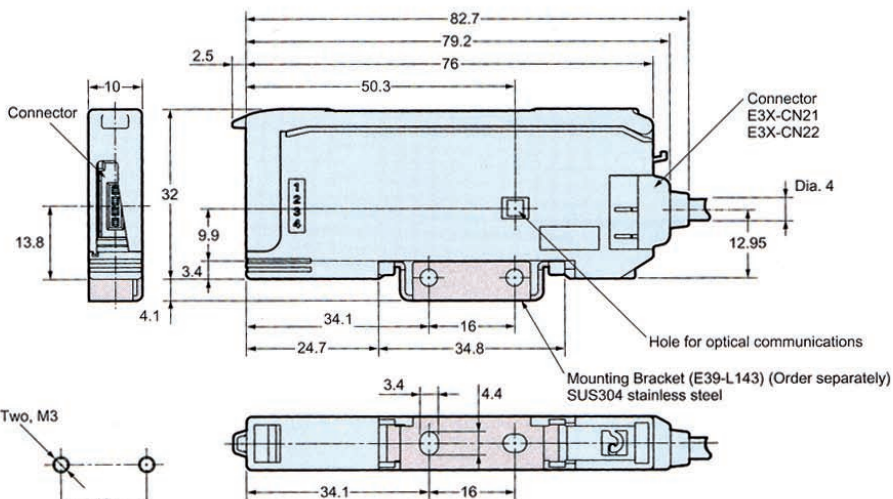

Dimensions (Unit: mm)

Master Connectors

E3X-CN11
E3X-CN21

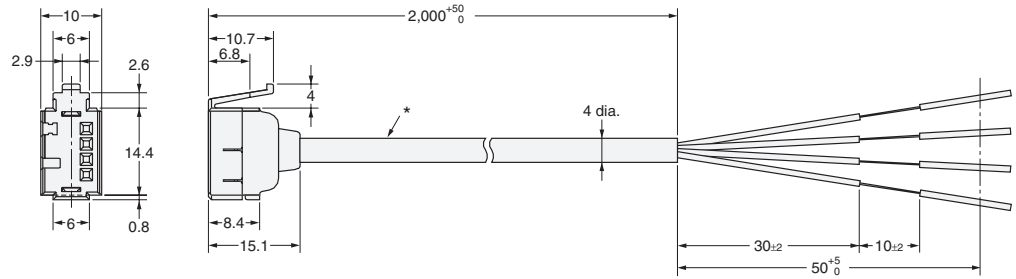
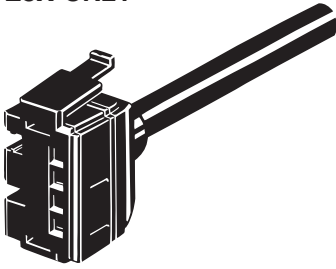

*E3C-CN11: A 4-dia., 3-conductor, vinyl-insulated round cable (conductor cross-sectional area: 0.2 mm²; insulation diameter: 1.1 mm) is used.
*E3C-CN21: A 4-dia., 4-conductor, vinyl-insulated round cable (conductor cross-sectional area: 0.2 mm²; insulation diameter: 1.1 mm) is used.

Slave Connectors

E3X-CN12
E3X-CN22

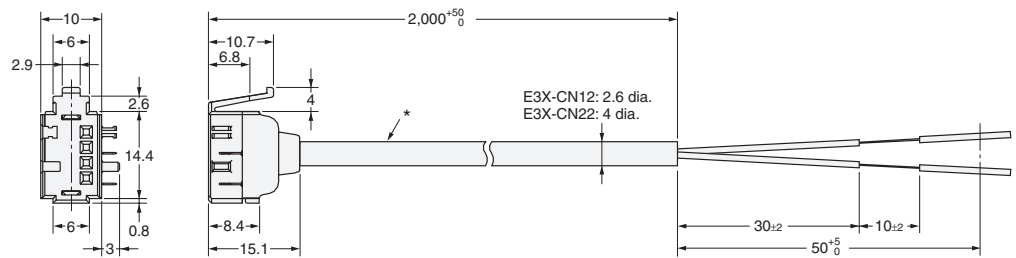
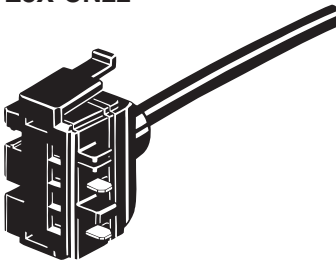

*E3C-CN12: A 2.6-dia., single-conductor, vinyl-insulated round cable (conductor cross-sectional area: 0.2 mm²; insulation diameter: 1.1 mm) is used.
*E3C-CN22: A 4-dia., 2-conductor, vinyl-insulated round cable (conductor cross-sectional area: 0.2 mm²; insulation diameter: 1.1 mm) is used.

Mounting Brackets

E39-L143

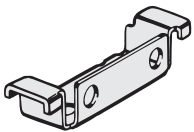

Material: Stainless steel (SUS304)

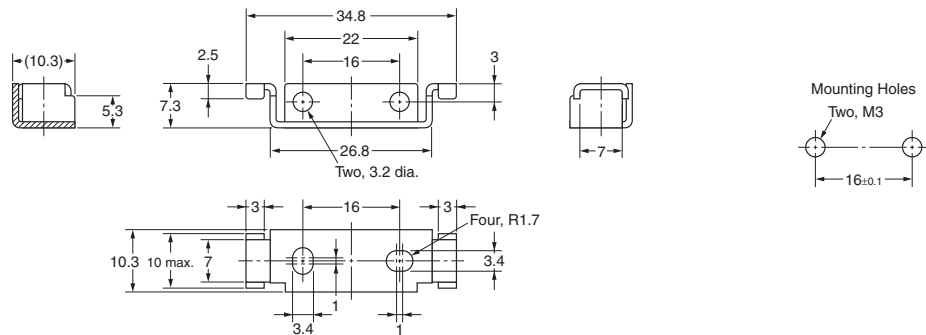

End Plates

PFP-M

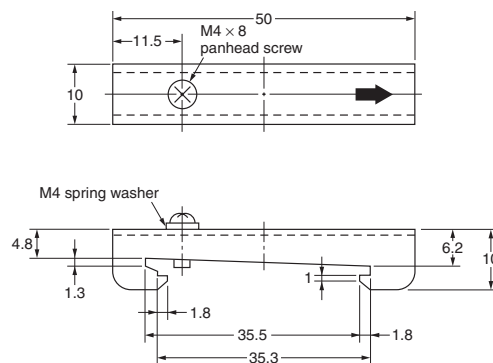
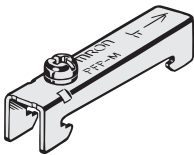

Mobile Console E3X-MC11-SV2

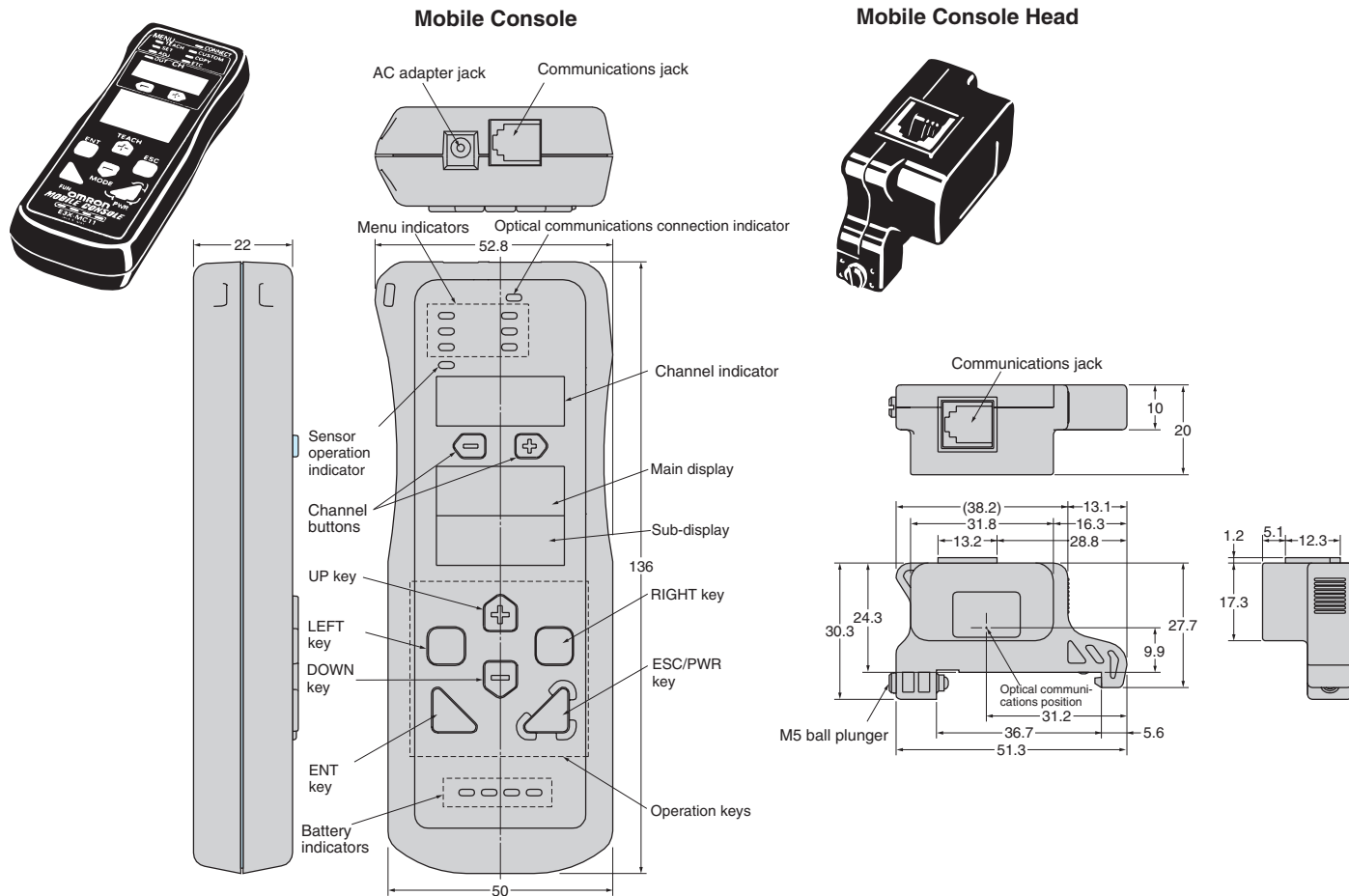

DeviceNet Communication Unit E3X-DRT21-S

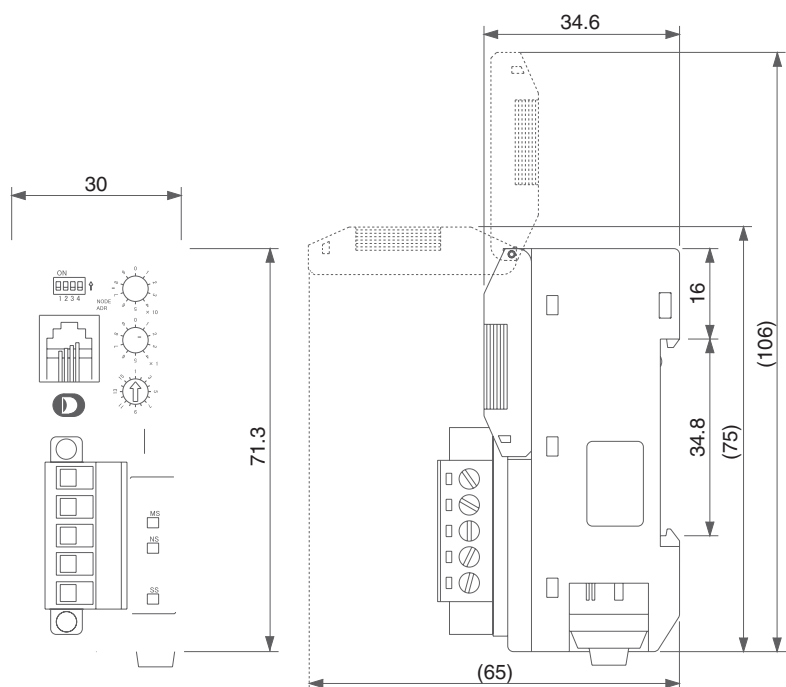

Part Number Index By Page Number

Model	Features/ Applications	Detecting Distance	Ratings/ Characteristics	Dimensions
E32-A01	14	38	50	65
E32-A02	14	38	50	65
E32-A03	16	39	50	66
E32-A03-1	16	39	50	66
E32-A04	16	40	50	67
E32-A04-1	16	40	50	67
E32-A07E1	15	39	50	66
E32-A07E2	15	39	50	66
E32-A08	15	39	50	66
E32-A09	15	39, 43	50	66
E32-A09H	15	39	50	66
E32-A09H2	15	39	49	66
E32-C11N		32	49	60
E32-C31		34, 43	49	61
E32-C31N		32	49	60
E32-CC200	9, 17	34, 43	49	61
E32-CC200R		34, 43	49	61
E32-D11	7	31, 43	49	59
E32-D11L	8, 17	33, 43	49	60
E32-D11N	7	32	49	60
E32-D11R	7	29, 43	49	58
E32-D11U	7	33, 43	50	59
E32-D12	7	30	49	58
E32-D12F	12	37, 44	49	64
E32-D12R	7	29, 43	49	58
E32-D14F	12	37, 44	50	64
E32-D14L	7	30	49	58
E32-D14LR	7	29, 43	49	58
E32-D15X	7	30	49	58
E32-D15XB	7	31, 43	49	60
E32-D15XR	7	29, 43	49	58
E32-D15Y	7	31	49	59
E32-D15YR	7	29, 43	49	59
E32-D15Z	7	31	49	59
E32-D15ZR	7	29, 43	49	59
E32-D16	8	33	49	60
E32-D21	7	32, 43	49	59
E32-D211		31, 43	49	58
E32-D211R		29	49	58
E32-D21B		32, 43	49	59
E32-D21L		33, 43	49	60
E32-D21R	7	29	49	58
E32-D22	7	31, 43	49	58
E32-D221B	7	32, 43	49	59
E32-D22B	7	32, 43	49	59
E32-D22L		33, 43	49	60
E32-D22R	7	29	49	58
E32-D24	7	31, 43	49	58
E32-D24R	7	30	49	58
E32-D25X	7	31, 43	49	58
E32-D25XB	7	32, 43	49	60
E32-D25XR	7	29	49	58
E32-D25Y	7	31, 43	49	59
E32-D25YR	7	30	49	59
E32-D25Z	7	31, 43	49	59
E32-D25ZR	7	30	49	59
E32-D32		34, 43	49	61
E32-D32L	9	34, 43	49	61
E32-D33	8	33	49	61

Model	Features/ Applications	Detecting Distance	Ratings/ Characteristics	Dimensions
E32-T15ZR	6	18, 41	49	52
E32-T16		25, 42	49	55
E32-T16J		24	49	55
E32-T16JR	10	24, 42	49	55
E32-T16P		24	49	55
E32-T16PR	10	24, 42	49	55
E32-T16W		24	49	54
E32-T16WR	10	24, 42	49	54
E32-T17L	8,17	21, 41	49	53
E32-T21	6	20, 41	49	52
E32-T21L		22	49	53
E32-T21R	6	18	49	51
E32-T22		19, 41	49	51
E32-T22B		20, 41	49	52
E32-T22R	6	18	49	51
E32-T221B		20, 41	49	52
E32-T222	6	19, 41	49	51
E32-T222R		18	49	51
E32-T223R	8	23	49	53
E32-T22B	6	20	49	52
E32-T22L		22, 41	49	53
E32-T22R	6	18	49	51
E32-T22S	10	23, 42	49	54
E32-T24	6	20, 41	49	51
E32-T24R	6	18	49	51
E32-T24S	10	23, 39, 42	50	54
E32-T25X	6	19, 41	49	51
E32-T25XB	6	20, 41	49	52
E32-T25XR	6	18	49	51
E32-T25Y	6	20, 41	49	52
E32-T25YR	6	18	49	52
E32-T25Z	6	20, 41	49	52
E32-T25ZR	6	18	49	52
E32-T333-S5		23	49	54
E32-T334-S5		23	49	54
E32-T33-S5		23	49	53
E32-T51		25, 42	50	55
E32-T51F		27, 42	50	56
E32-T51V 1M		27, 42	50	57
E32-T54		25, 42	50	55
E32-T54V 1M	13	28, 42	50	57
E32-T61-S	12	26, 42	50	56
E32-T81F-S	12	27, 42	50	56
E32-T81R-S		26, 42	50	56
E32-T84S-S	12	26, 42	50	56
E32-T84SV 1M	13	28, 42	50	57
E32-TC200	6	19, 41	49	51
E32-TC200A		19	49	51
E32-TC200B	6	19	49	51
E32-TC200B4		19	49	51
E32-TC200B4R	18	18, 41	49	51
E32-TC200BR	6	18, 41	49	51
E32-TC200E	6	19, 41	49	51
E32-TC200F	6	19, 41	49	51
E32-TC200F4		19, 41	49	51
E32-TC200F4R		18	49	51
E32-TC200FR	6	18	49	51
E3C-LD11	81	81	83	51
E3C-LD21	81	81	83	85

Model	Features/ Applications	Detecting Distance	Ratings/ Characteristics	Dimensions
E32-D331	8	33	49	61
E32-D36P1	10	35, 43	49	62
E32-D36T	14	38	50	65
E32-D51		36, 44	50	63
E32-D61		37	50	64
E32-D61-S	12	37, 44	50	64
E32-D73		37	50	64
E32-D73-S	12	37, 44	50	64
E32-D81R		37	50	63
E32-D81R-S		37, 44	50	63
E32-D82F1	14	38	50	66
E32-D82F2		38	50	66
E32-DC200	7	30, 43	49	58
E32-DC200B	7	30	49	58
E32-DC200B4		30	49	58
9E32-DC200B4R		29, 43	49	58
E32-DC200BR	7	29, 43	49	58
E32-DC200E	7	31, 43	49	58
E32-DC200F	7	31, 43	49	58
E32-DC200F4		31, 43	49	58
E32-DC200F4R		29	49	58
E32-DC200FR	7	29	49	58
E32-ET16WR-1		25	49	55
E32-ET16WR-2		25	49	55
E32-G14	14	38, 42	50	65
E32-L16	11, 15	36, 39	50	62
E32-L24L	11	36	49	62
E32-L24S	11	35	49	62
E32-L25		35	49	63
E32-L25A		35	49	63
E32-L25L	11	36	49	62
E32-L25T		38	50	65
E32-L66	15	39	50	66
E32-L86	11	36	49	63
E32-M21		25	50	54
E32-R16	11	35	49	62
E32-R21	11	35	49	62
E32-T10V 2M	13		50	
E32-T11		20, 41	49	52
E32-T11F	12	26, 42	50	56
E32-T11L	8	22, 41	49	53
E32-T11N	6	20	49	53
E32-T11R	6, 17	18, 41	49	51
E32-T11U	6	21, 41	50	52
E32-T12	6	19	49	51
E32-T12B	6	20, 41	49	52
E32-T12F	12	27, 42	50	56
E32-T12L		22, 41	49	53
E32-T12R	6	18, 41	49	51
E32-T14	8, 14	22, 38, 41	50	53
E32-T14F	12	27, 42	50	56
E32-T14L	6	19	49	51
E32-T14LR	6	18, 41	49	51
E32-T15X	6	19	49	51
E32-T15XB	6	20, 41	49	52
E32-T15XR	6	18, 41	49	51
E32-T15Y		19	49	52
E32-T15YR		18, 41	49	52
E32-T15Z	6	19	49	52

Model	Features/ Applications	Detecting Distance	Ratings/ Characteristics	Dimensions
E3C-LD31	81	81	83	85
E3C-LDA11	82		84	85
E3C-LDA11AN	82		84	94
E3C-LDA21	82		84	94
E3C-LDA41	82		84	94
E3C-LDA41AN	82		84	94
E3C-LDA51	82		84	94
E3C-LDA6	82		84	94
E3C-LDA7	82		84	94
E3C-LDA8	82		84	94
E3C-LDA9	82		84	94
E3C-LR11	81	81	83	94
E3C-LR12	81	81	83	85
E3X-DA11RW-S	75		76	85
E3X-DA11-S	75		76	92
E3X-DA11TW-S	75		76	92
E3X-DA41RW-S	75		76	92
E3X-DA41-S	75		76	92
E3X-DA41TW-S	75		76	92
E3X-DA6RW-S	75		76	93
E3X-DA6-S	75		76	93
E3X-DA6TW-S	75		76	93
E3X-DABRW-S	75		76	93
E3X-DAB-S	75		76	93
E3X-DABTW-S	75		76	93
E3X-DAB11-S	75		76	92
E3X-DAB41-S	75		76	92
E3X-DAB6-S	75		76	93
E3X-DAB8-S	75		76	93
E3X-DAC11-S	79		80	92
E3X-DAC21-S	79		80	92
E3X-DAC41-S	79		80	92
E3X-DAC51-S	79		80	92
E3X-DAC6-S	79		80	93
E3X-DAC8-S	79		80	93
E3X-DAG11-S	75		76	92
E3X-DAG41-S	75		76	92
E3X-DAG6-S	75		76	93
E3X-DAG8-S	75		76	93
E3X-DRT21-S	88		89	97
E3X-MDA11	77		78	92
E3X-MDA41	77		78	92
E3X-MDA6	77		78	93
E3X-MDA8	77		78	93
E3X-NA11	73		74	90
E3X-NA11F	73		74	90
E3X-NA11V	73		74	91
E3X-NA14V	73		74	91
E3X-NA41	73		74	90
E3X-NA41F	73		74	90
E3X-NA41V	73		74	91
E3X-NA44V	73		74	91
E3X-NA6	73		74	90
E3X-NA8	73		74	90
E3X-SD11	73		74	90
E3X-SD41	73		74	90
E3X-SD6	73		74	90
E3X-SD8	73		74	90



OMRON ELECTRONICS LLC • THE AMERICAS HEADQUARTERS

Schaumburg, IL USA • 847.843.7900 • 800.556.6766 • www.omron247.com

OMRON CANADA, INC. • HEAD OFFICE

Toronto, ON, Canada • 416.286.6465 • 866.986.6766 • www.omron.ca

OMRON ELETRÔNICA DO BRASIL LTDA • HEAD OFFICE

São Paulo, SP, Brasil • 55.11.2101.6300 • www.omron.com.br

OMRON ELECTRONICS MEXICO SA DE CV • HEAD OFFICE

Apodaca, N.L. • 52.811.156.99.10 • 001.800.556.6766 • mela@omron.com

OMRON ARGENTINA • SALES OFFICE

Cono Sur • 54.11.4783.5300

OMRON CHILE • SALES OFFICE

Santiago 56.9.9917.3920

OTHER OMRON LATIN AMERICA SALES

54.11.4783.5300