

Advanced Dual Fiber Sensors E3X-MDA

Two Amplifiers Squeezed into a Single Sensor Provide Significant Cost, Space and Labor Savings

- Two channels accept two sets of fiber cables.
- AND/OR control output eliminates the need for a PLC or sensor controller.
- 4 element LED and Auto Power Control ensure stable, long term performance.
- Improved remote programmer.
- Same ease-of-use as the E3X-DA-N amplifiers.



Ordering Information

■ Amplifier Units

Stock Note: Shaded items are normally stocked.

Amplifier Units with Cables

Item	Appearance	Functions	Model	
			NPN output	PNP output
2-channel models		AND/OR output	E3X-MDA11	E3X-MDA41

Amplifier Units with Connectors

Stock Note: Shaded items are normally stocked.

Item	Appearance	Functions	Model	
			NPN output	PNP output
2-channel models		AND/OR output	E3X-MDA6	E3X-MDA8

■ Amplifier Unit Connectors (Order Separately)

Stock Note: Shaded items are normally stocked.

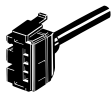
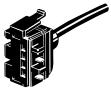
Item	Appearance	Cable length	No. of conductors	Model
Master Connector		2 m	3	E3X-CN11
			4	E3X-CN21
Slave Connector			1	E3X-CN12
			2	E3X-CN22

Combining Amplifier Units and Connectors

Amplifier Units and Connectors are sold separately. Refer to the following tables when placing an order.

Amplifier Unit			Applicable Connector (Order Separately)	
Model	NPN output	PNP output	Master Connector	Slave Connector
2-channel models	E3X-MDA6	E3X-MDA8	E3X-CN21 (4-wire)	E3X-CN22 (2-wire)

Combining Multiple Wire-Saving Amplifiers and Connector Cables

When combining wire-saving amplifiers, the amplifiers that are connected together must all have the same part number. Only one master connector is required. The master connector cable distributes power to all the “ganged” wire-saving amplifiers. The rest of the wire-saving amplifiers require slave connector cables; slave connector cables handle output signal transmission only.



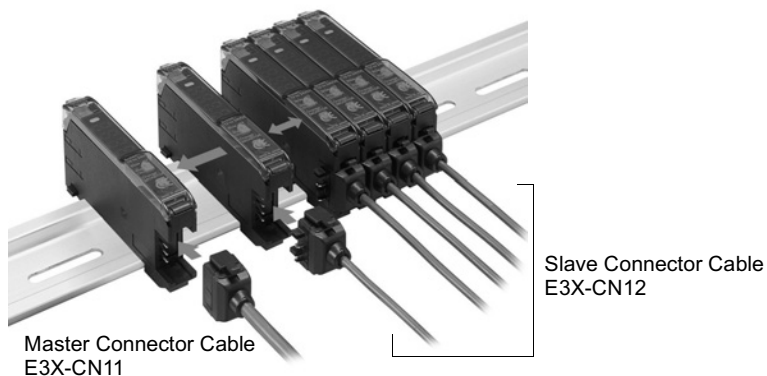

Example: Requirements for combining 5 E3X-MDA6 amplifiers:

- 1 master connector cable
- 5 slave connector cables
- 6 E3X-MDA6 amplifiers



Mobile Console (Order Separately)

Stock Note: Shaded items are normally stocked.

Appearance	Model	Remarks
	E3X-MC11-S (model number of set)	Mobile Console with Head, Cable, and AC adapter provided as accessories
	E3X-MC11-C1-S	Mobile Console
	E3X-MC11-H1	Head
	E39-Z12-1	Cable (1.5 m)

Note: Use the E3X-MC11-S Mobile Console for the E3X-DA-S/MDA-series Amplifier Units. Other Mobile Consoles cannot be used.

Accessories (Order Separately)

Stock Note: Shaded items are normally stocked.

Mounting Bracket

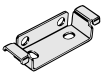
Appearance	Model	Quantity
	E39-L143	1

End Plate

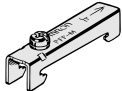
Appearance	Model	Quantity
	PFP-M	1

Specifications

■ Ratings/Characteristics

Amplifier Units

Item	Type		2-channel models	
	Model	NPN output	E3X-MDA11	E3X-MDA6
		PNP output	E3X-MDA41	E3X-MDA8
Light source (wavelength)			Red LED (650 nm)	
Supply voltage			12 to 24 VDC ±10%, ripple (p-p) 10% max.	
Power consumption			1,080 mW max. (current consumption: 45 mA max. at power supply voltage of 24 VDC)	
Control output			Load power supply voltage: 26.4 VDC; open collector; load current: 50 mA max.; residual voltage: 1 V max.	
Circuit protection			Reverse polarity for power supply connection, output short-circuit	
Response time	High-speed mode	NPN	130 μs ^{*1} for operation and reset respectively	
		PNP		
	Standard mode		1 ms for operation and reset respectively	
	High-resolution mode		4 ms for operation and reset respectively	
Sensitivity setting			Teaching or manual method	
Functions	Power tuning		Light emission power and reception gain, digital control method	
	Timer function		Select from OFF-delay, ON-delay, or one-shot timer. 1 ms to 5 s (1 to 20 ms set in 1-ms increments, 20 to 200 ms set in 10-ms increments, 200 ms to 1 s set in 100-ms increments, and 1 to 5 s set in 1 s-increments)	
	Automatic power control (APC)		High-speed control method for emission current	
	Zero-reset		Display can be reset to zero when required (negative values can be displayed).	
	Initial reset		Settings can be returned to defaults as required.	
	Mutual interference prevention		Possible for up to 9 Units (18 channels) ^{*2, *3}	
	I/O settings		Output setting (Select from channel 2 output, AND, OR, leading edge sync, falling edge sync, or differential output)	
Display			Operation indicator for channel 1 (orange), Operation indicator for channel 2 (orange)	
Digital display			Select from the following: Incident level for channel 1 + incident level for channel 2, Incident level + threshold, incident level percentage + threshold, incident light peak level + no incident light bottom level, minimum incident light peak level + maximum no incident light bottom level, long bar display, incident level + peak hold, incident level + channel	
Display orientation			Normal/reverse program selectable	
Ambient illumination (receiver side)			Incandescent lamp:10,000 lux max. Sunlight:20,000 lux max.	
Ambient temperature			Operating:Groups of 1 to 2 Amplifiers: -25°C to 55°C Groups of 3 to 10 Amplifiers: -25°C to 50°C Groups of 11 to 16 Amplifiers: -25°C to 45°C (with no icing or condensation) Storage: -30°C to 70°C (with no icing or condensation)	
Ambient humidity			Operating and storage: 35% to 85% (with no condensation)	
Insulation resistance			20 MΩ min. (at 500 VDC)	
Dielectric strength			1,000 VAC at 50/60 Hz for 1 minute	
Vibration resistance (destruction)			10 to 55 Hz with a 1.5-mm double amplitude for 2 hrs each in X, Y and Z directions	
Shock resistance (destruction)			500 m/s ² , for 3 times each in X, Y and Z directions	
Enclosure rating			IEC 60529 IP50 (with Protective Cover attached)	
Connection method			Prewired cable	Standard connector
Weight (packed state)			Approx. 100 g	Approx. 55 g
Materials	Case		Polybutylene terephthalate (PBT)	
	Cover		Polycarbonate (PC)	
Accessories			Instruction sheet	

Note: *1. When differential output is selected for the output setting, the second channel output is 200 μs for operation and reset respectively.

*2. Communications are disabled if the detection mode is selected during high-speed mode, and the communications functions for mutual interference prevention and the Mobile Console will not function.

*3. Mutual interference prevention can be used for up to 5 Units (10 channels) if power tuning is enabled.

Amplifier Unit Connectors

Item	E3X-CN11/21/22	E3X-CN12
Rated current	2.5 A	
Rated voltage	50 V	
Contact resistance	20 mΩ max. (20 mVDC max., 100 mA max.) (The figure is for connection to the Amplifier Unit and the adjacent Connector. It does not include the conductor resistance of the cable.)	
No. of insertions (destruction)	50 times (The figure for the number of insertions is for connection to the Amplifier Unit and the adjacent Connector.)	
Materials	Housing	Polybutylene terephthalate (PBT)
	Contacts	Phosphor bronze/gold-plated nickel
Weight (packed state)	Approx. 55 g	Approx. 25 g

Mobile Console

Item	E3X-MC11-S
Supply voltage	Charged with AC adapter
Connection method	Connected via adapter
Weight (packed state)	Approx. 580 g (Console only: 120 g)

Note: Refer to *Operation Manual* provided with the Mobile Console for details.











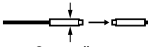

Ordering Information: Fiber Units

■ Through-beam Fiber Units

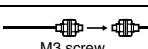
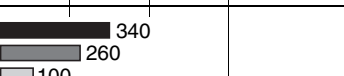
- Note:** 1.  Indicates models that allow free cutting. Models without this mark do not allow free cutting.
 2. The size of standard sensing object is the same as the fiber core diameter (lens diameter for models with lens).
 3. The values for the minimum sensing object are representative values that indicate values obtained in standard mode with the sensing distance and sensitivity set to optimum values.

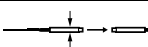
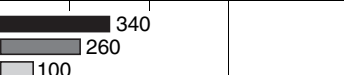
Long-distance Fiber Units

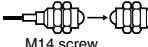
 : High-resolution mode  : Standard mode  : Super-high-speed mode

Features	Appearance	Applicable Amplifier Unit	Sensing distance (mm) (Parentheses: With E39-F1 Lens Unit)	Standard object (min. object) (Parentheses: Opaque object)	Model	Permissible bending radius
M4 	 M4 screw	E3X-MDA	 1,100 (2,600)*1 870 (2,000) 350 (840)	1.4-mm dia. (0.01-mm dia.)	E32-T11L	25 mm
3-mm dia. 	 3-mm dia.	E3X-MDA	 1,100 870 350		E32-T12L	
M3 	 M3 screw	E3X-MDA	 340 260 100	0.9-mm dia. (0.005-mm dia.)	E32-T21L	10 mm
2-mm dia.; small diameter 	 2-mm dia.	E3X-MDA	 340 260 100		E32-T22L	
M14; with lens; ideal for explosion-proof applications 	 M14 screw	E3X-MDA	 13,000 10,000 4,000	10-mm dia.	E32-T17L	25 mm

A Wide Range of Multicore Fibers for Easy Installation without Loss of Light Intensity

Multicore fiber models are indicated by an "R" at the end of the model number.

Multicore fiber contains multiple cores. These cores are all surrounded by cladding, giving a minimum bending radius of 1 mm.

The fiber can be bent at right angles without affecting the light intensity. Handle it just like any other cable.
 Note: Do not use this fiber in applications that have repetitive bending.

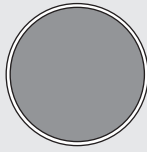

Conventional Fiber

Conventional fiber uses just one core and one cladding section. Bending the fiber may break it or reduce the light intensity.

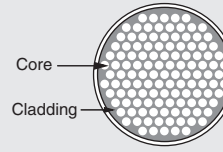

Multicore Fiber







Multicore fiber contains multiple independent cores all surrounded by cladding. The fiber can be bent without breaking or reducing the light intensity.

General-purpose Fiber Units

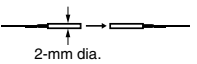
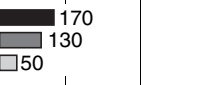
Features	Appearance	Applicable Amplifier Unit	Sensing distance (mm) (Parentheses: With E39-F1 Lens Unit)	Standard object (min. object) (Parentheses: Opaque object)	Model	Permissible bending radius
M4	M4 screw	E3X-MDA	650 (4,000)* 500 (3,700) 200 (1,500)	1.0-mm dia. (0.005-mm dia.)	E32-TC200	25 mm
M4 Multicore	M4 screw	E3X-MDA	450 (3,100) 350 (2,400) 140 (970)		E32-T11R	1 mm
M4 Fiber-sheath material: fluororesin	M4 screw	E3X-MDA	580 (3,000)* 450 (2,300) 180 (930)		E32-T11U <i>NEW</i>	4 mm
3-mm dia. Multicore	3-mm dia.	E3X-MDA	450 350 140		E32-T12R	1 mm
M3 Possible to mount the E39-F5 Reflective Side-view Conversion Attachment	M3 screw	E3X-MDA	580 450 180		E32-TC200A	25 mm
M3; for detecting minute objects	M3 screw	E3X-MDA	170 130 50		E32-TC200E	10 mm
M3 Multicore	M3 screw	E3X-MDA	100 75 30	E32-T21R	1 mm	

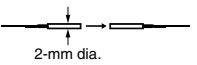
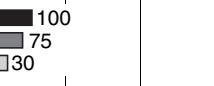
Note: *The optical fiber is 2 m long on each side, so the sensing distance is 4,000 mm.

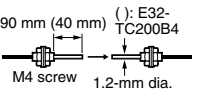
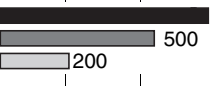
Fiber Units with Thin Heads

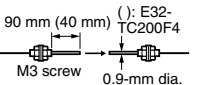
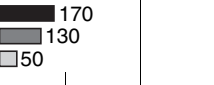



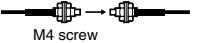
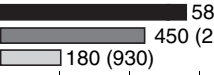
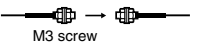
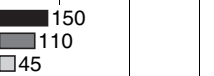
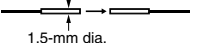
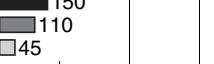



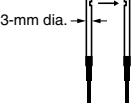
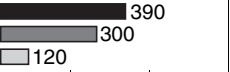

Features	Appearance	Applicable Amplifier Unit	Sensing distance (mm) (Parentheses: With E39-F1 Lens Unit)	Standard object (min. object) (Parentheses: Opaque object)	Model	Permissible bending radius
2-mm dia.; for detecting minute objects 	 2-mm dia.	E3X-MDA	 170 130 50	0.5-mm dia. (0.005-mm dia.)	E32-T22	10 mm
2-mm dia.; for detecting minute objects Multicore 	 2-mm dia.	E3X-MDA	 100 75 30		E32-T22R	1 mm
1.2-mm dia.; with sleeve 	 90 mm (40 mm) (): E32-TC200B4 M4 screw 1.2-mm dia.	E3X-MDA	 650 500 200	1.0-mm dia. (0.005-mm dia.)	E32-TC200B E32-TC200B4	25 mm
0.9-mm dia.; with sleeve 	 90 mm (40 mm) (): E32-TC200F4 M3 screw 0.9-mm dia.	E3X-MDA	 170 130 50	0.5-mm dia. (0.005-mm dia.)	E32-TC200F E32-TC200F4	10 mm

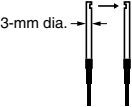
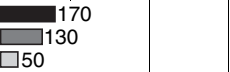
Flexible Fiber Units (Resists Breaking) (R4)



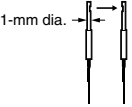

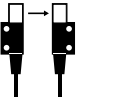
Features	Appearance	Applicable Amplifier Unit	Sensing distance (mm) (Parentheses: With E39-F1 Lens Unit)	Standard object (min. object) (Parentheses: Opaque object)	Model	Permissible bending radius	
Ideal for mounting on moving sections (R4) 	 M4 screw	E3X-MDA	 580 (3,000) 450 (2,300) 180 (930)	1.0-mm dia. (0.005-mm dia.)	E32-T11	4 mm	
	 M3 screw	E3X-MDA	 150 110 45		0.5-mm dia. (0.005-mm dia.)		E32-T21
	 1.5-mm dia.	E3X-MDA	 150 110 45		E32-T22B		

Note: *The optical fiber is 2 m long on each side, so the sensing distance is 4,000 mm.

Side-view Fiber Units

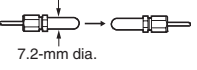
Features	Appearance	Applicable Amplifier Unit	Sensing distance (mm) (Parentheses: With E39-F1 Lens Unit)	Standard object (min. object) (Parentheses: Opaque object)	Model	Permissible bending radius
Long distance; space-saving 		E3X-MDA	 390 300 120	1.0-mm dia. (0.005-mm dia.)	E32-T14L	25 mm
Space-saving; Multicore 		E3X-MDA	 170 130 50		E32-T14LR	1 mm
Suitable for detecting minute objects; small diameter 		E3X-MDA	 100 70 30	0.5-mm dia. (0.005-mm dia.)	E32-T24	10 mm
Suitable for detecting minute objects; small diameter; Multicore 		E3X-MDA	 35 27 10		E32-T24R	1 mm
Screw-mounting type; long distance 		E3X-MDA	 2,900 2,200 900	4-mm dia. (0.1-mm dia.)	E32-T14	25 mm

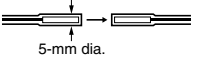
Chemical-resistant Fiber Units

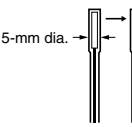
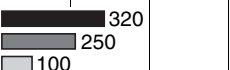
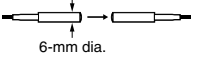
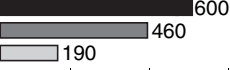
Features	Appearance	Applicable Amplifier Unit	Sensing distance (mm) (Parentheses: With E39-F1 Lens Unit)	Standard object (min. object) (Parentheses: Opaque object)	Model	Permissible bending radius
Teflon-covered*; round head that resists water drops 	 7.2-mm dia.	E3X-MDA	 1,600 1,300 520	4-mm dia. (0.1-mm dia.)	E32-T11F NEW	4 mm
Teflon-covered*; withstands chemicals and harsh environments (operating ambient temperature: -30°C to 70°C) 	 5-mm dia.	E3X-MDA	 2,600 2,000 800	4-mm dia. (0.1-mm dia.)	E32-T12F	40 mm
Teflon-covered*; withstands chemicals and harsh environments; side-view (operating ambient temperature: -30°C to 70°C) 	 5-mm dia.	E3X-MDA	 320 250 100	3-mm dia. (0.1-mm dia.)	E32-T14F	
Teflon*; withstands chemicals and harsh environments (operating ambient temperature: -40°C to 200°C)	 6-mm dia.	E3X-MDA	 600 460 190	1.0-mm dia. (0.005-mm dia.)	E32-T81F-S NEW	10 mm

Note: *Teflon is a registered trademark of the Dupont Company and the Mitsui Dupont Chemical Company for their fluoride resin.

Heat-resistant Fiber Units

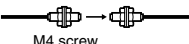
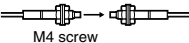
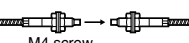
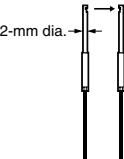
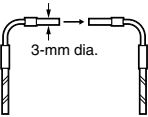
Features	Appearance	Applicable Amplifier Unit	Sensing distance (mm) (Parentheses: With E39-F1 Lens Unit)	Standard object (min. object) (Parentheses: Opaque object)	Model	Permissible bending radius
Resists 150°C ^{*1} ; fiber sheath material: fluoro-resin (operating ambient temperature: -40°C to 150°C)	 M4 screw	E3X-MDA	650 500 200	1.5-mm dia. (0.1-mm dia.)	E32-T51	35 mm
Resists 200°C; flexible (R10); fiber sheath material: Teflon ^{*2} (operating ambient temperature: -40°C to 200°C)	 M4 screw	E3X-MDA	230 (1,700) 180 (1,300) 70 (520)	1.0-mm dia. (0.005-mm dia.)	E32-T81R-S <i>NEW</i>	10 mm
Resists 350°C ^{*3} , with spiral tube; high mechanical strength; fiber sheath material: stainless steel (operating ambient temperature: -60°C to 350°C)	 M4 screw	E3X-MDA	390 (3,000) 300 (2,200) 120 (900)		E32-T61-S <i>NEW</i>	25 mm
Side-view; resists 150°C ^{*1} ; suitable for detecting minute objects; fiber sheath material: fluoro-resin (operating ambient temperature: -40°C to 150°C)	 2-mm dia.	E3X-MDA	190 150 60		E32-T54	35 mm
Resists 200°C ^{*3} ; L-shaped; fiber sheath material: stainless steel	 3-mm dia.	E3X-MDA	1,100 870 350	1.7-mm dia. (0.1-mm dia.)	E32-T84S-S <i>NEW</i>	25 mm

Note: *1. For continuous operation, use the products within a temperature range of -40°C to 130°C.







*2. Teflon is a registered trademark of the Dupont Company and the Mitsui Dupont Chemical Company for their fluoride resin.

*3. Indicates the heat-resistant temperature at the fiber tip.

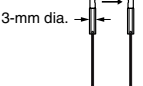
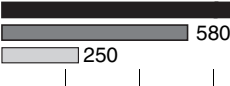

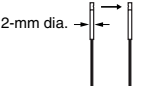
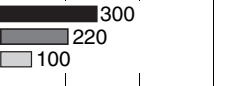

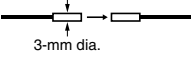

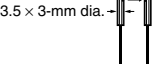
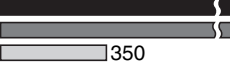



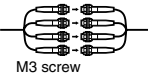
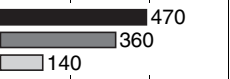

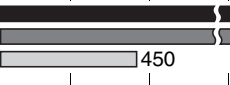
Fiber Unit with Slot Sensor

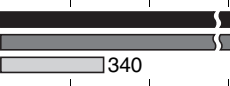
Features	Appearance	Applicable Amplifier Unit	Sensing distance (mm) (Parentheses: With E39-F1 Lens Unit)	Standard object (min. object) (Parentheses: Opaque object)	Model	Permissible bending radius
Suitable for film sheet detection; no optical axis adjustment required; easy to mount	 4-mm dia.	E3X-MDA	110 110 110	4-mm dia. (0.1-mm dia.)	E32-G14	25 mm

Fiber Units with a Narrow Vision Field

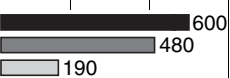
Features	Appearance	Applicable Amplifier Unit	Sensing distance (mm) (Parentheses: With E39-F1 Lens Unit)	Standard object (min. object) (Parentheses: Opaque object)	Model	Permissible bending radius
Super-narrow vision field; side-view; opening angle: 1.5°; simple adjustment 	3-mm dia. 	E3X-MDA		2-mm dia. (0.1-mm dia.)	E32-A03	1 mm
Super-narrow vision field; small; side-view; opening angle: 3°; simple adjustment 	2-mm dia. 	E3X-MDA		1.2-mm dia. (0.1-mm dia.)	E32-A04	10 mm
Suitable for detecting wafers 		E3X-MDA		1.7-mm dia. (0.1-mm dia.)	E32-T22S	25 mm
Side-view; suitable for detecting wafers 	3.5 × 3-mm dia. 	E3X-MDA		2-mm dia. (0.1-mm dia.)	E32-T24S	10 mm

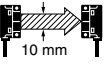
Area-sensing Fiber Units

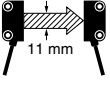
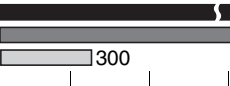
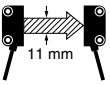
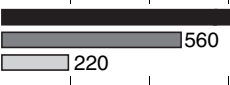
Features	Appearance	Applicable Amplifier Unit	Sensing distance (mm) (Parentheses: With E39-F1 Lens Unit)	Standard object (min. object) (Parentheses: Opaque object)	Model	Permissible bending radius
Multi-point detection (4-head) 	M3 screw	E3X-MDA		2-mm dia. (0.1-mm dia.)	E32-M21	25 mm
Detects in a 30-mm area 		E3X-MDA		(0.3-mm dia.) ^{*1}	E32-T16W	10 mm
		E3X-MDA			E32-T16WR (Multicore)	1 mm
Side-view; suitable for applications with limited spatial depth 		E3X-MDA		(0.2-mm dia.) ^{*1}	E32-T16J	10 mm
		E3X-MDA			E32-T16JR (Multicore)	1 mm
Suitable for detecting over a 10-mm area; long distance 		E3X-MDA		(0.6-mm dia.) ^{*2}	E32-T16	25 mm
Stable for detecting minute objects in a wide area 		E3X-MDA		(0.2-mm dia.) ^{*1}	E32-T16P	10 mm
		E3X-MDA			E32-T16PR (Multicore)	1 mm







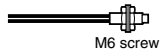

Note: *1. These figures are for a sensing distance of 300 mm. (Figures for the diameter of sensing objects are in the still state.)

*2. These figures are ones for which detection is possible in each sensing area at a digital incident level of 1,000. (Figures for the diameter of sensing objects are in the still state.)

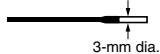
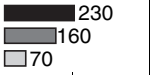
Diffuse Fiber Units

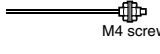
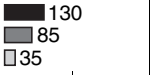

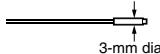
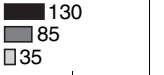

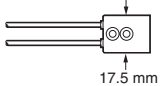
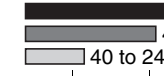





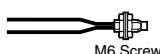
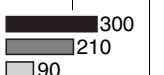

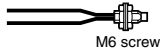
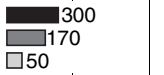
- Note:** 1.  Indicates models that allow free cutting. Models without this mark do not allow free cutting.
 2. The values for the minimum sensing object are representative values that indicate values obtained in standard mode with the sensing distance and sensitivity set to optimum values.
 3. When set to the maximum sensitivity setting, internal light reflection may cause the sensor to detect incident light. In such case, adjust the threshold manually or automatically (teaching).

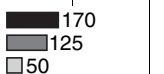
Long-distance Fiber Units

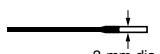
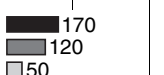
Features	Appearance	Applicable Amplifier Unit	Sensing distance (mm)*	Standard object (min. object: Gold wire)	Model	Permissible bending radius
M6 	 M6 screw	E3X-MDA	 400 270 110	500×500 (0.005-mm dia.)	E32-D11L	25 mm
3-mm dia.; small diameter 	 3-mm dia.	E3X-MDA	 230 160 70	300×300 (0.005-mm dia.)	E32-D12	
M4 	 M4 screw	E3X-MDA	 130 85 35	200×200 (0.005-mm dia.)	E32-D21L	10 mm
3-mm dia.; small diameter 	 3-mm dia.	E3X-MDA	 130 85 35		E32-D22L	
Square head, long distance 	 17.5 mm	E3X-MDA	 40 to 600 40 to 490 40 to 240	300×300	E32-D16 NEW	4 mm

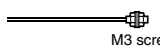
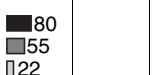

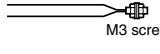
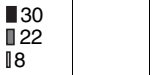

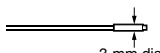
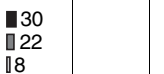
Note: *Values were obtained using a white paper (standard object).

General-purpose Fiber Units

Features	Appearance	Applicable Amplifier Unit	Sensing distance (mm)*	Standard object (min. object: Gold wire)	Model	Permissible bending radius
M6 	 M6 screw	E3X-MDA	 300 210 90	400×400 (0.005-mm dia.)	E32-DC200	25 mm
M6 Multicore 	 M6 screw	E3X-MDA	 300 170 50	300×300 (0.005-mm dia.)	E32-D11R	1 mm
M6 Fiber sheath material: fluororesin 	 M6 screw	E3X-MDA	 170 125 50		E32-D11U NEW	4 mm
3-mm dia. Multicore 	 3-mm dia.	E3X-MDA	 170 120 50		E32-D12R	1 mm
M3; small diameter 	 M3 screw	E3X-MDA	 80 55 22	100×100 (0.005-mm dia.)	E32-DC200E	10 mm
M3; small diameter Multicore 	 M3 screw	E3X-MDA	 30 22 8	50×50 (0.005-mm dia.)	E32-D21R	1 mm
3-mm dia.; small diameter; multicore 	 3-mm dia.	E3X-MDA	 30 22 8		E32-D22R	

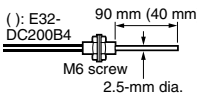

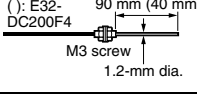

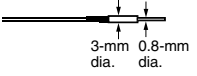
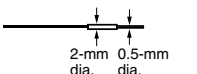
Note: *Values were obtained using a white paper (standard object).

Fiber Units with Thin Heads

Features	Appearance	Applicable Amplifier Unit	Sensing distance (mm)*			Standard object (min. object: Gold wire)	Model	Permissible bending radius
2.5-mm dia.; with sleeve 	() : E32-DC200B4 	E3X-MDA	■ 300 ■ 210 □ 90			400×400 (0.005-mm dia.)	E32-DC200B E32-DC200B4	25 mm
1.2-mm dia.; with sleeve 	() : E32-DC200F4 	E3X-MDA	■ 80 ■ 55 □ 22			100×100 (0.005-mm dia.)	E32-DC200F E32-DC200F4	10 mm
0.8-mm dia.; for detecting minute objects 		E3X-MDA	■ 16 □ 10 □ 14			25×25 (0.005-mm dia.)	E32-D33	4 mm
0.5-mm dia.; for detecting very minute objects		E3X-MDA	■ 13 □ 12 □ 10.8				E32-D331	

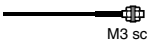
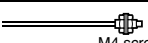
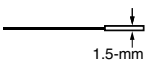

Note: *Values were obtained using a white paper (standard object).

Flexible Fiber Units (Resists Breaking) (R4)

Features	Appearance	Applicable Amplifier Unit	Sensing distance (mm)*			Standard object (min. object: Gold wire)	Model	Permissible bending radius
Ideal for mounting on moving sections (R4)   		E3X-MDA	■ 170 ■ 125 □ 50			300×300 (0.005-mm dia.)	E32-D11	4 mm
		E3X-MDA	■ 30 □ 22 □ 18			50×50 (0.005-mm dia.)	E32-D21	
		E3X-MDA	■ 70 ■ 50 □ 20			100×100 (0.005-mm dia.)	E32-D21B	
		E3X-MDA	■ 30 □ 22 □ 18			50×50 (0.005-mm dia.)	E32-D22B	



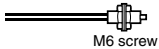
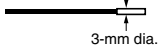

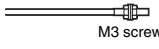
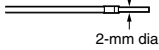
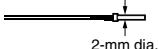
Note: *Values were obtained using a white paper (standard object).

Coaxial Fiber Units





Features	Appearance	Applicable Amplifier Unit	Sensing distance (mm)*			Standard object (min. object: Gold wire)	Model	Permissible bending radius
M6 coaxial; high-precision positioning	 M6 screw	E3X-MDA	300	210	90	500×500 (0.005-mm dia.)	E32-CC200	25 mm
3-mm dia.; small diameter; coaxial; high-precision positioning	 3-mm dia.	E3X-MDA	150	100	45	300×300 (0.005-mm dia.)	E32-D32L	
M3 coaxial; high-precision positioning	 M3 screw	E3X-MDA	75	50	22	100×100 (0.005-mm dia.)	E32-C31	
M3 coaxial; high-precision positioning	 M3 screw	E3X-MDA	35	22	8	50×50 (0.005-mm dia.)	E32-C41	
2-mm dia. coaxial; high-precision positioning	 2-mm dia.	E3X-MDA	35	22	8		E32-C42	
2-mm dia. coaxial; high-precision positioning	 2-mm dia.	E3X-MDA	75	52	22	100×100 (0.005-mm dia.)	E32-D32	

Note: Values were obtained using a white paper (standard object).

Spot Diameter (Order Lens separately)

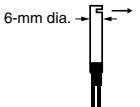

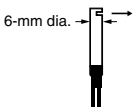
Lens	Appearance	Focusing lens type	Spot diameter values	
E39-F3A		Variable	E32-C42 Spot: 0.1-0.6 mm dia.	E32-D32 Spot: 0.5-1.0 mm dia.
E39-F3A-5		Fixed	E32-C31 Spot: 0.5 mm dia. Focal length: 7 mm	E32-C41 Spot: 0.1 mm dia. Focal length: 7 mm
E39-F3B			E32-C31 Spot: 0.5 mm dia. Focal length: 17 mm	E32-C41 Spot: 0.2 mm dia. Focal length: 17 mm
E39-F3C			E32-C31 Spot: 4.0 mm dia. Focal length: 20 mm	E32-C41 Spot: 4.0 mm dia. Focal length: 20 mm

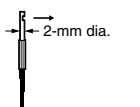
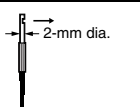
Side-view Fiber Units

Features	Appearance	Applicable Amplifier Unit	Sensing distance (mm)*			Standard object (min. object: Gold wire)	Model	Permissible bending radius
6-mm dia.; long distance 		E3X-MDA	■ 110	■ 80	□ 36	200×200 (0.005-mm dia.)	E32-D14L	25 mm
6-mm dia. 		E3X-MDA	■ 45	■ 33	□ 14	100×100 (0.005-mm dia.)	E32-D14LR (Multicore)	1 mm
2-mm dia.; small diameter; space-saving 		E3X-MDA	■ 30	■ 22	□ 8	50×50 (0.005-mm dia.)	E32-D24	10 mm
		E3X-MDA	■ 15	■ 10	□ 4		E32-D24R (Multicore)	1 mm

Note: *Values were obtained using a white paper (standard object).

Chemical-resistant Fiber Units

Features	Appearance	Applicable Amplifier Unit	Sensing distance (mm)* ¹			Standard object (min. object: Gold wire)	Model	Permissible bending radius
Teflon-covered ² ; withstands chemicals and harsh environments (operating ambient temperature: -30°C to 70°C) 		E3X-MDA	■ 95	■ 70	□ 30	200×200 (0.005-mm dia.)	E32-D12F	40 mm

Note: *1. Values were obtained using a white paper (standard object).

*2. Teflon is a registered trademark of the Dupont Company and the Mitsui Dupont Chemical Company for their fluoride resin.

Heat-resistant Fiber Units

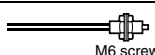
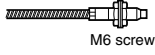
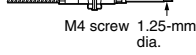
Features	Appearance	Applicable Amplifier Unit	Sensing distance (mm) ^{*1}			Standard object (min. object: Gold wire)	Model	Permissible bending radius
Resists 150°C ^{*2} ; fiber sheath material: fluoro-resin (operating ambient temperature: -40°C to 150°C)		E3X-MDA	230	165	72	200×200 (0.005-mm dia.)	E32-D51	35 mm
Resists 200°C ^{*3} ; fiber sheath material: fluoro-resin (operating ambient temperature: -40°C to 200°C)		E3X-MDA	90	63	27		E32-D81R-S <i>NEW</i>	10 mm
Resists 350°C ^{*3} ; fiber sheath material: stainless steel (operating ambient temperature: -60°C to 350°C)		E3X-MDA	90	60	27		E32-D61-S <i>NEW</i>	25 mm
Resists 400°C ^{*3} ; fiber sheath material: stainless steel (operating ambient temperature: -40°C to 400°C)		E3X-MDA	60	40	18	100×100 (0.005-mm dia.)	E32-D73-S <i>NEW</i>	

Note: *1. Values were obtained using a white paper (standard object).

*2. For continuous operation, use the products within a temperature range of -40°C to 130°C.

*3. Indicates the heat-resistant temperature at the fiber tip.

Area-sensing Fiber Units

Features	Appearance	Applicable Amplifier Unit	Sensing distance (mm)*			Standard object (min. object: Gold wire)	Model	Permissible bending radius
Side-view; detection over wide areas		E3X-MDA	150	100	45	300×300 (0.005-mm dia.)	E32-D36P1	25 mm





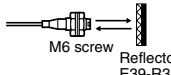
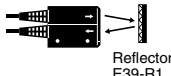



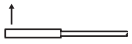

Note: *Values were obtained using a white paper (standard object).

Retroreflective Fiber Units

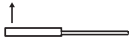
Features	Appearance	Applicable Amplifier Unit	Sensing distance (mm)*			Standard object (min. object: Gold wire)	Model	Permissible bending radius
Transparent object detection; polarized		E3X-MDA	10 to 250	10 to 250	10 to 250	35-mm dia. (0.1-mm dia.)	E32-R21 + E39-R3 (Attachment)	10 mm
Transparent object detection (operating ambient temperature: -25°C to 55°C); degree of protection: IEC60529 IP66; polarized		E3X-MDA	150 to 1,500	150 to 1,500	150 to 1,500	35-mm dia. (0.2-mm dia.)	E32-R16 + E39-R1 (Attachment)	25 mm

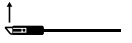
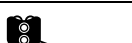



Note: *Values were obtained using a white paper (standard object).

Convergent Fiber Units

Features	Appearance	Applicable Amplifier Unit	Sensing distance (mm)*			Standard object (min. object: Gold wire)	Model	Permissible bending radius
Suitable for positioning liquid crystal glass 		E3X-MDA	10 to 15	10 to 15	10 to 15	100×100 Soda glass with reflection factor of 7%	E32-L16 NEW	25 mm
Suitable for positioning liquid crystal glass 		E3X-MDA	14 to 12	14 to 12	14 to 12		E32-L56E1 E32-L56E2	35 mm
Suitable for positioning liquid crystal glass (Resists 300°C)		E3X-MDA	15 to 18	15 to 18	15 to 18		E32-L66 NEW	25 mm
Liquid crystal glass, mounting detection, small 		E3X-MDA	10 to 4	10 to 4	10 to 4	25×25 (0.005-mm dia.)	E32-L24S NEW	10 mm
Detects wafers and small differences in height; (operating ambient temperature: -40°C to 105°C); degree of protection: IEC60529 IP50 		E3X-MDA	14±2	14±2	14±2		E32-L24L	10 mm
		E3X-MDA	17.2±1.8	17.2±1.8	17.2±1.8		E32-L25L	
Detects wafers and small differences in height; degree of protection: IEC60529 IP50 		E3X-MDA	13.3	13.3	13.3		E32-L25	25 mm
		E3X-MDA	13.3	13.3	13.3		E32-L25A	

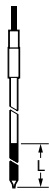
Note: *Values were obtained using a white paper (standard object).

Fluid-level Detection Fiber Units

Features	Appearance	Applicable Amplifier Unit	Sensing distance (mm)	Standard object (min. object: Gold wire)	Model	Permissible bending radius
Fluid contact type: unbendable section L 150 mm, 350 mm (two types); (operating ambient temperature: -40°C to 200°C)		E3X-MDA	---	Pure water at 25°C	E32-D82F1 E32-D82F2	40 mm
Tube-mounting type; Light ON when fluid is present; minimal influence from bubbles and water drops		E3X-MDA	Applicable tube: Transparent tube Tube diameter: 3.2, 6.4, or 9.5 mm (Tube must be FEP or material with equivalent transparency; recommended wall thickness: 1 mm)		E32-A01	4 mm
Tube-mounting type; light ON when fluid is present; minimal influence from bubbles and water drops		E3X-MDA	Applicable tube: Transparent tube Tube diameter: 6 to 13 mm (Tube must be FEP or material with equivalent transparency; recommended wall thickness: 1 mm)		E32-A02	
Tube-mounting type; dense mounting to detect level differences of 4 mm		E3X-MDA	Applicable tube: Transparent tube Tube diameter: 8 to 10 mm (Tube must be FEP or material with equivalent transparency; recommended wall thickness: 1 mm)		E32-L25T	10 mm
Tube-mounting type; unlimited tube diameter; minimal influence from bubbles and water drops		E3X-MDA	Applicable tube: Transparent tube Tube diameter: No restriction (Tube must be FEP or material with equivalent transparency)		E32-D36F	4 mm

Output Circuits

NPN Output

Model	Mode selector	Timing chart	State of output transistor	Output circuit
E3X-MDA11 E3X-MDA6	LIGHT ON (L/ON)	<p>CH1/CH2 Incident light </p> <p>CH1/CH2 No incident light </p> <p>Operation indicator (orange) ON </p> <p>Operation indicator (orange) OFF </p> <p>Output transistor ON </p> <p>Output transistor OFF </p> <p>Load (relay) Operate </p> <p>Load (relay) Release </p> <p>(Between brown and black)</p>	Light ON	
	DARK ON (D/ON)	<p>CH1/CH2 Incident light </p> <p>CH1/CH2 No incident light </p> <p>Operation indicator (orange) ON </p> <p>Operation indicator (orange) OFF </p> <p>Output transistor ON </p> <p>Output transistor OFF </p> <p>Load (relay) Operate </p> <p>Load (relay) Release </p> <p>(Between brown and black)</p>	Dark ON	

Note: 1. Time Charts for Timer Settings (T: Set Time)

ON delay	OFF delay	One-shot

2. Control Output (AND, OR, Sync) and Time Chart for Timer Settings (T: Set Time)

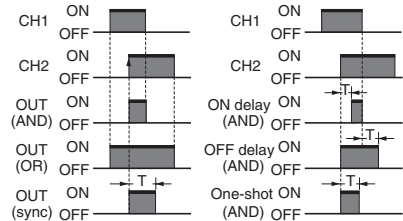

PNP Output

Model	Mode selector	Timing chart	State of output transistor	Output circuit
E3X-MDA41 E3X-MDA8	LIGHT ON (L/ON)	CH1/ Incident light CH2/ No incident light Operation indicator (orange) ON OFF Output transistor ON OFF Load (relay) Operate Release (Between blue and black)	Light ON	
	DARK ON (D/ON)	CH1/ Incident light CH2/ No incident light Operation indicator (orange) ON OFF Output transistor ON OFF Load (relay) Operate Release (Between blue and black)	Dark ON	

Note: 1. Time Charts for Timer Settings (T: Set Time)

ON delay	OFF delay	One-shot

2. Control Output (AND, OR, Sync) and Time Chart for Timer Settings (T: Set Time)

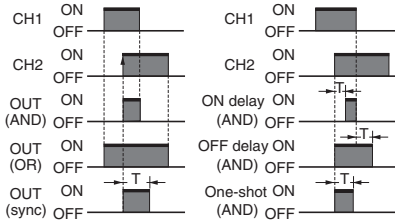

Nomenclature

■ Amplifier Units

E3X-MDA□

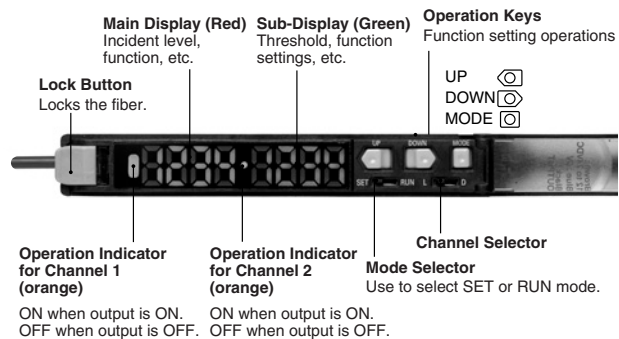

Adjustment Methods

1. Setting the Operation Mode

The operation mode is set in SET mode. Refer to *Section 5. Setting Functions in SET Mode on page 22*.

Set the Channel Selector to the desired channel before making any adjustments or settings.

2. Adjusting the Power (RUN Mode)

The current incident light level can be adjusted to near the power tuning target value (default: 2,000).

Confirm that the MODE key setting is PTUN (power tuning). The default setting is PTUN. Refer to *Section 5. Setting Functions in SET Mode on page 22*

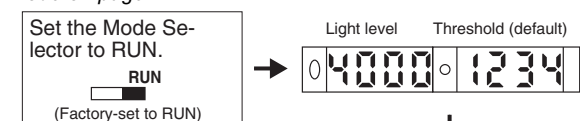

Release the key after the progress bar is displayed.

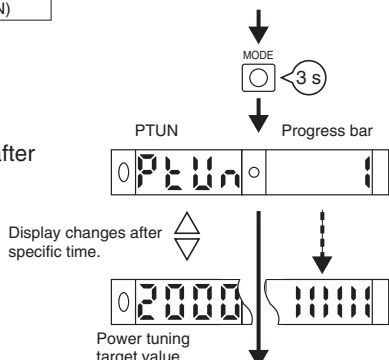

The Power Tuning indicator will light when the adjustment has been completed.



To restore the default power settings:

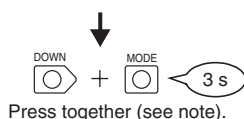

"OFF" will flash twice.



The Power Tuning indicator will go out when the default setting has been restored.



Setting Errors

An error has occurred if one of the following displays appears after the progress bar is displayed.

Display	Error	Action
<p>PTUN OVER</p>	Over Error The incident light level is too low for the power tuning target value.	The power will not be tuned. The power can be increased up to approximately 5 times the incident light value.
<p>PTUN BOTM</p>	Bottom Error The incident light level is too high for the power tuning target value.	The power will be tuned to the minimum level. The power can be decreased down to approximately 1/25th the incident light value.

Note: Press the DOWN key right after pressing the MODE key.

3. Setting Thresholds Manually (RUN Mode)

A threshold can be set manually. A threshold value can also be fine-tuned using manual setting after teaching.

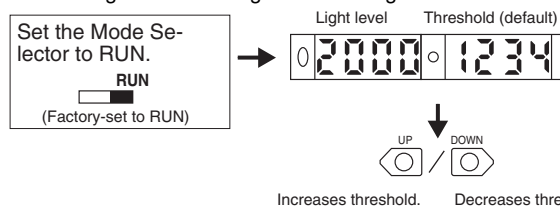

Note: Even if the display method for display switching is changed, the threshold will appear on the sub-display when the key is pressed.

4. Teaching the Threshold Value (SET Mode)

There are four methods that can be used for teaching, as described below. Use the method most suitable for the application.

An error has occurred if OVER, LO, or NEAR is displayed on the sub-display. Repeat the operation from the beginning.

4-1. Setting the Threshold at Maximum Sensitivity

The threshold can be set at the maximum sensitivity. This method is ideal when using a Through-beam Fiber Unit to detect workpieces so that detection is not influenced to any great degree by dust and other environmental factors.

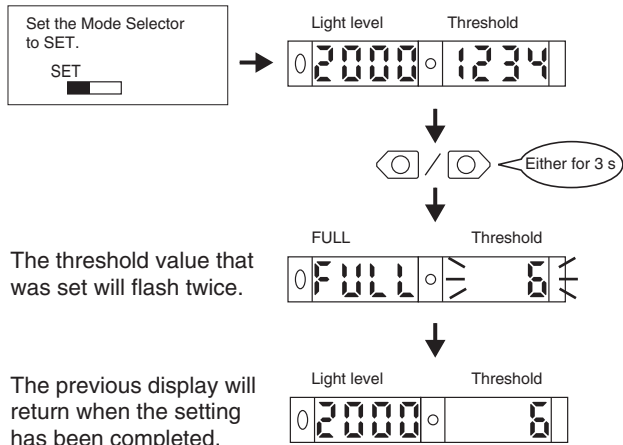

The threshold value that was set will flash twice.

The previous display will return when the setting has been completed.

4-2. Teaching a Through-beam Fiber Unit without a Workpiece

A value about 6% less than the incident light level can be set as the threshold value. This method is ideal when detecting very small differences in light level, such as when detecting very fine workpieces or transparent objects.

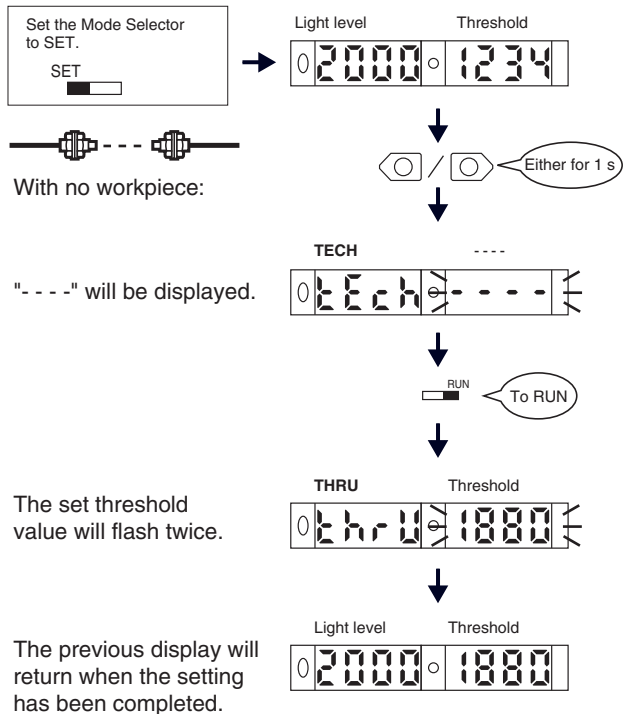

With no workpiece:

"----" will be displayed.

The set threshold value will flash twice.

The previous display will return when the setting has been completed.

4-3. Teaching a Diffuse Fiber Unit without a Workpiece

A value about 6% greater than the incident light level can be set as the threshold value. This method is ideal when using a Reflective Fiber Unit to detect workpieces so that detection is not influenced to any great degree by dust and other environmental factors.

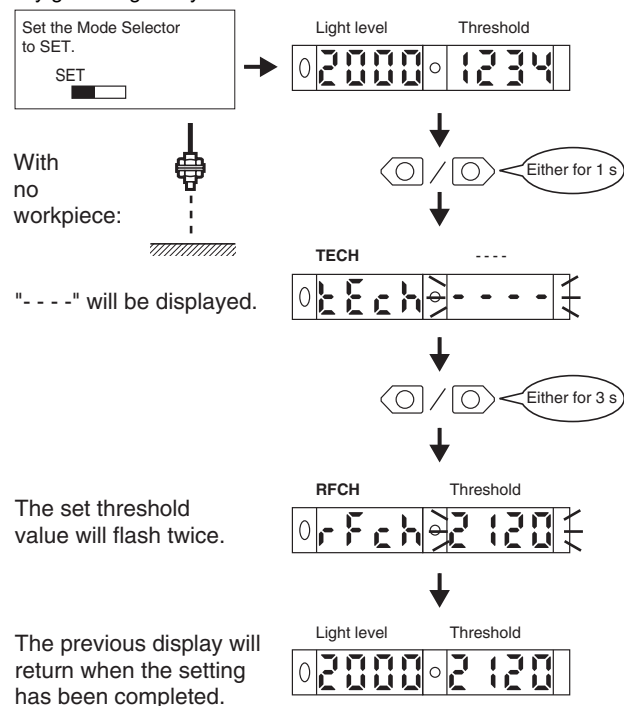

With no workpiece:

"----" will be displayed.

The set threshold value will flash twice.

The previous display will return when the setting has been completed.

4-4. Teaching With and Without a Workpiece

Teaching can be performed twice, once with and once without a workpiece, and the value between the two measured value can be set as the threshold.

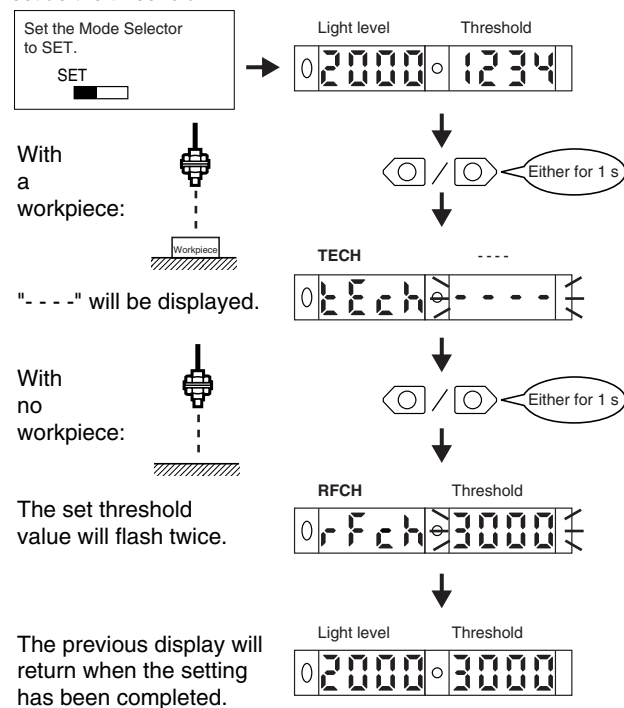

With a workpiece:

"----" will be displayed.

The set threshold value will flash twice.

The previous display will return when the setting has been completed.

5. Setting Functions in SET Mode

* The default settings are shown in the transition boxes between functions.

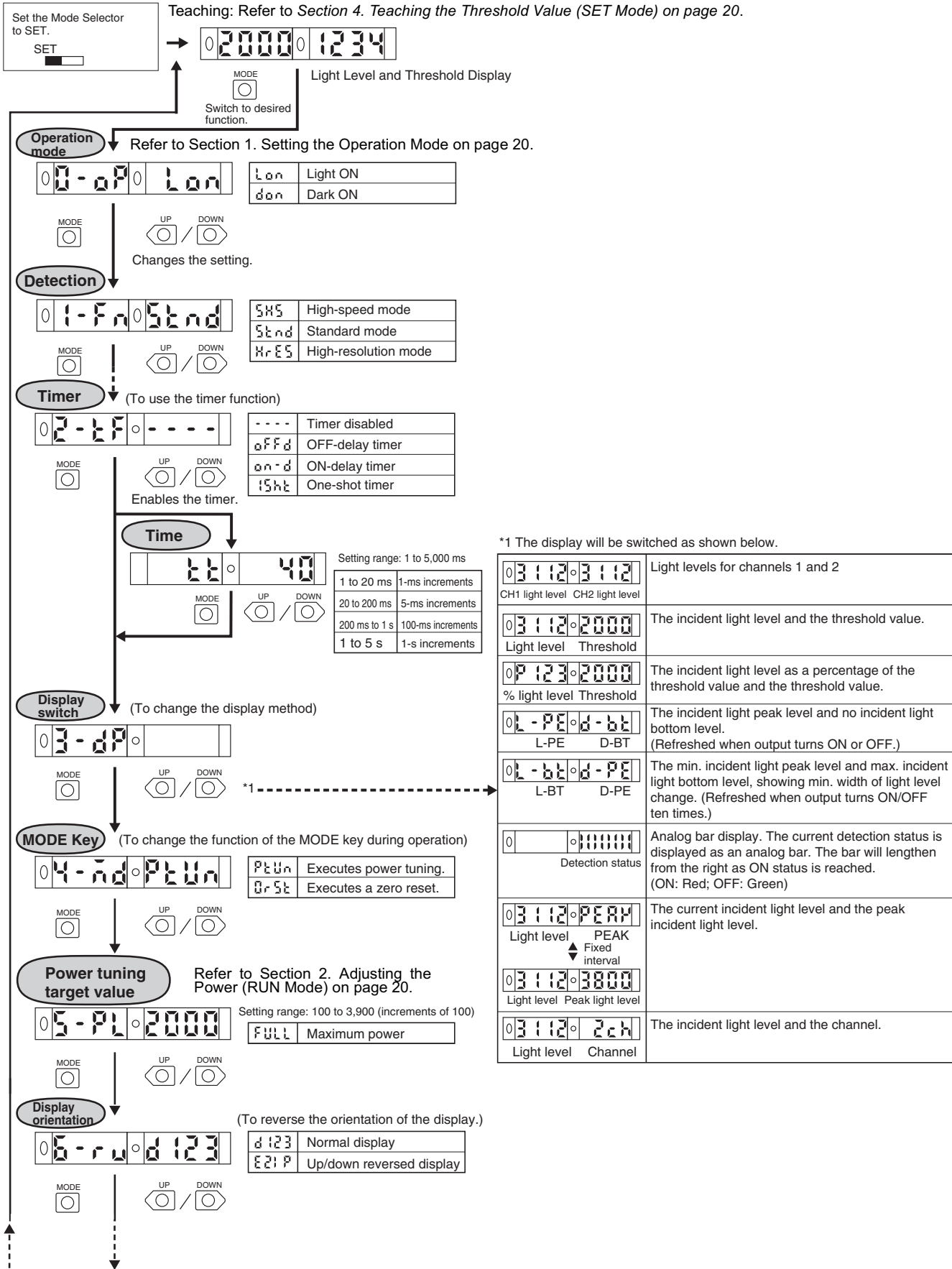

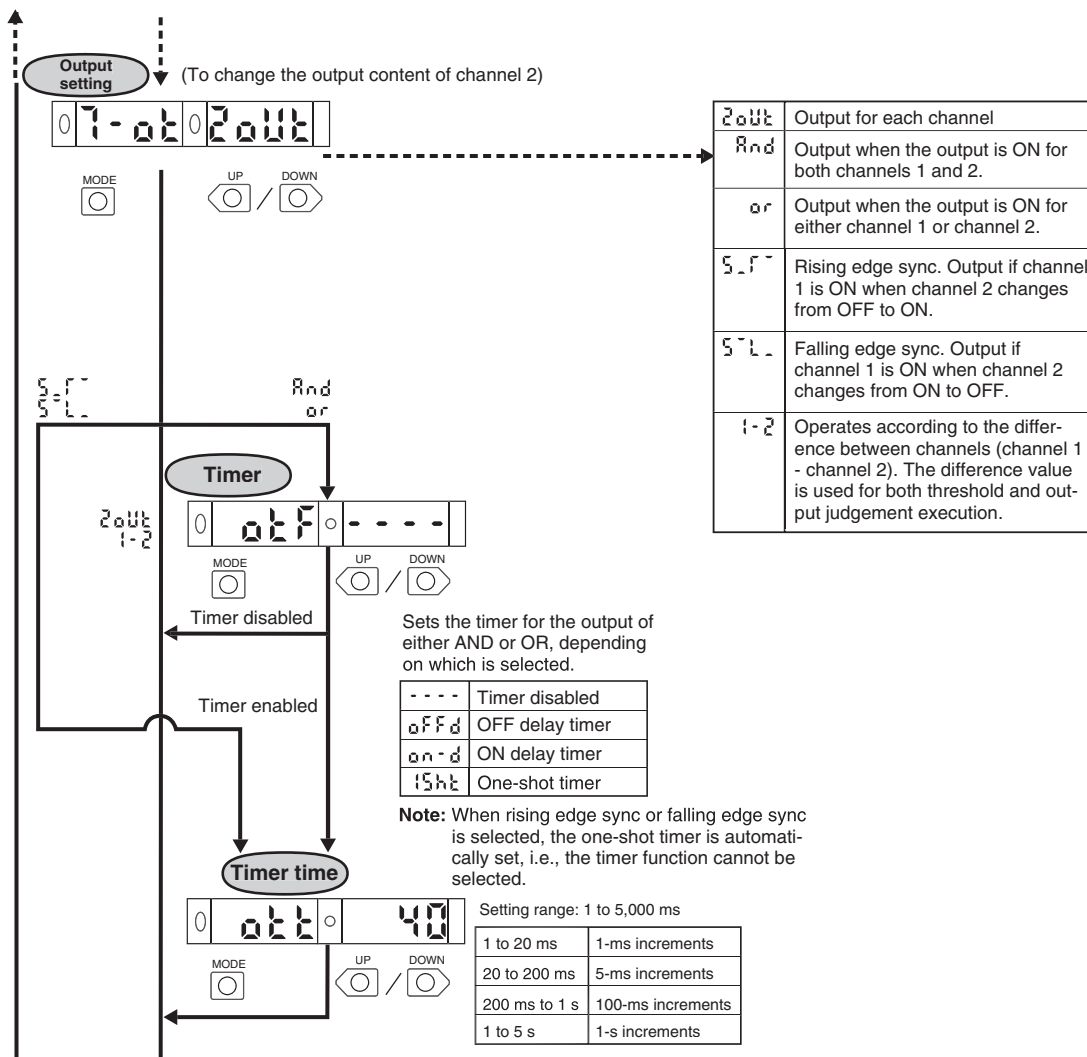

6. Convenient Functions

6-1. Zeroing the Digital Display

The incident light level on the digital display can be set to 0.

* Change the function to 0 (zero reset) as outlined on page 22.
The default setting is PTUN.

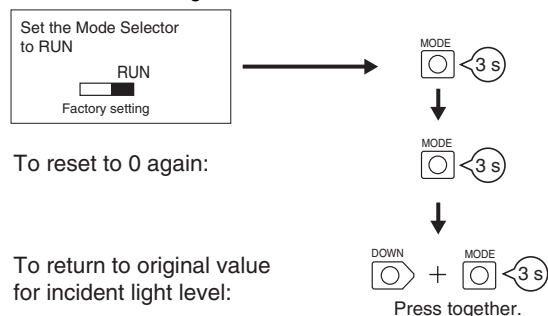

6-2. Locking the Keys

All key operations can be disabled.

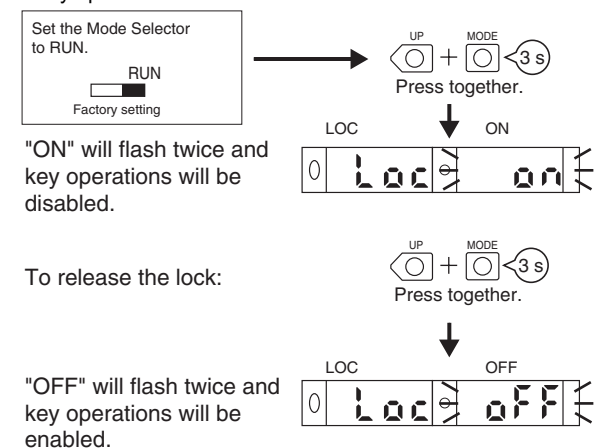

* If a key is pressed while key operations are locked, "LOC" will flash twice on the display to indicate that key operations have been disabled.

Note: Press the DOWN or UP key right after pressing the MODE key.

6-3. Initializing Settings

All settings can be returned to their original default settings.

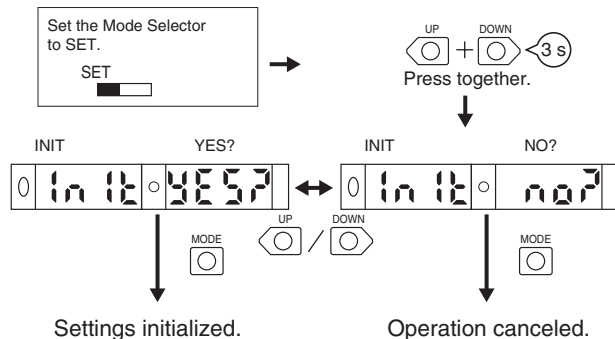

Safety Precautions

Note: In addition to the following precautions, please read and observe the common precautions in the instruction sheet accompanying the product.

■ Amplifier Unit

Installation

Operation after Turning Power ON

The Amplifier Unit is ready to operate within 200 ms after the power supply is turned ON. If the Sensor and load are connected to separate power supplies, be sure to turn ON the power supply of the Sensor first.

Mounting

Connecting and Disconnecting Connectors

Mounting Connectors

1. Insert the Master or Slave Connector into the Amplifier Unit until it clicks into place.

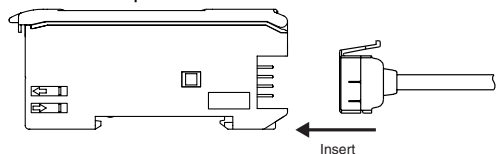

2. Attach the protector seals (provided as accessories) to the sides of master and slave connectors that are not connected.

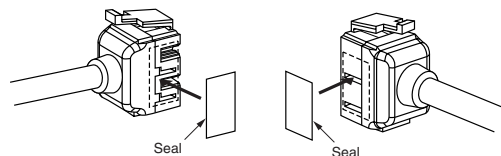

Note: Attach the seals to the sides with grooves

Removing Connectors

1. Slide the slave Amplifier Unit(s) for which the Connector is to be removed away from the rest of the group.
2. After the Amplifier Unit(s) has been separated, press down on the lever on the Connector and remove it. (Do not attempt to remove Connectors without separating them from other Amplifier Units first.)

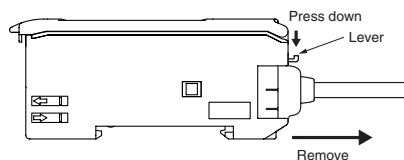

Joining and Removing Amplifier Units

Joining Amplifier Units

1. Mount the Amplifier Units one at a time onto the DIN track.

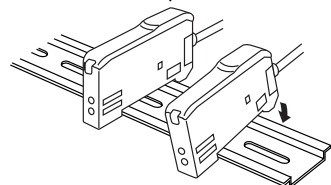

2. Slide the Amplifier Units together, line up the clips, and press the Amplifier Units together until they click into place.

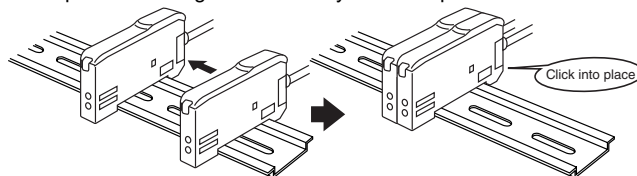

Separating Amplifier Units

Slide Amplifier Units away from each other, and remove from the DIN track one at a time. (Do not attempt to remove Amplifier Units from the DIN track without separating them first.)

Note 1. The specifications for ambient temperature will vary according to the number of Amplifier Units used together. For details, refer to *Ratings/Characteristics*.

2. Always turn OFF the power supply before joining or separating Amplifier Units.

Mounting the End Plate (PFP-M)

An End Plate should be used if there is a possibility of the Amplifier Unit moving, e.g., due to vibration. If a Mobile Console is going to be mounted, connect the End Plate in the direction shown in the following diagram.

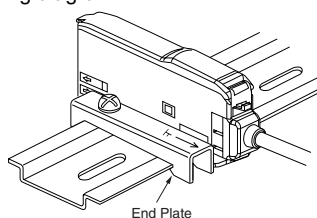

Mounting the Mobile Console Head

Leave a gap of at least 20 mm between the nearest Amplifier Unit and the Mobile Console head.

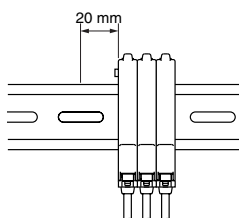

Fiber Connection

The E3X Amplifier Unit has a lock button for easy connection of the Fiber Unit. Connect or disconnect the fibers using the following procedures:

1. Connection

Open the protective cover, insert the fibers according to the fiber insertion marks on the side of the Amplifier Unit, and lower the lock button.

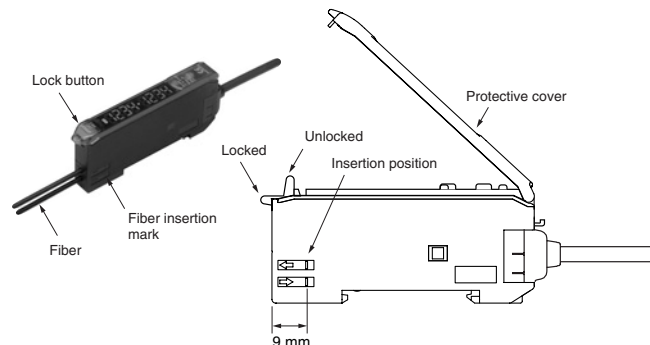

Fibers with E39-F9 Attachment

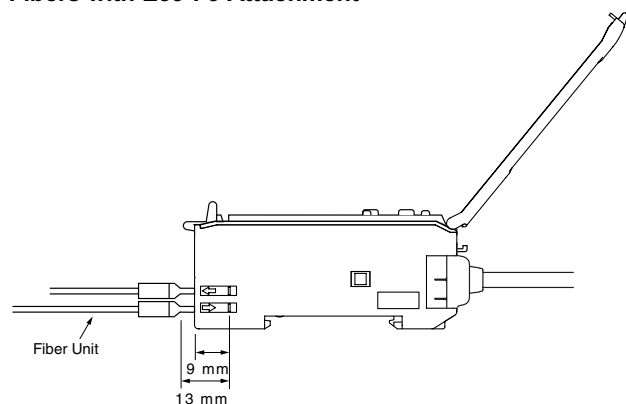

Fibers That Cannot Be Free-Cut (with Sleeves)

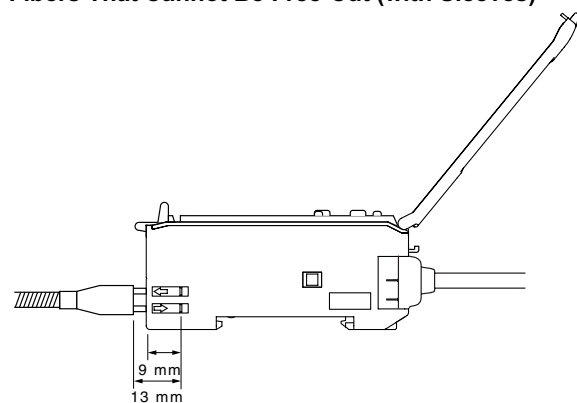

2. Disconnecting Fibers

Remove the protective cover and raise the lock button to pull out the fibers.

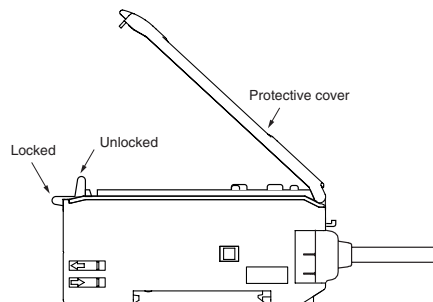

Note: 1. To maintain the fiber properties, confirm that the lock is released before removing the fibers.

2. Be sure to lock or unlock the lock button within an ambient temperature range between -10°C and 40°C .

Adjustments

Mutual Interference Protection Function

There may be some instability in the digital display values due to light from other sensors. If this occurs, decrease the sensitivity (i.e., decrease the power or increase the threshold) to perform stable detection.

EEPROM Writing Error

If the data is not written to the EEPROM correctly due to a power failure or static-electric noise, initialize the settings with the keys on the Amplifier Unit. ERR/EEP will flash on the display when a writing error has occurred.

Optical Communications

Several Amplifier Units can be slid together and used in groups. Do not, however, slide the Amplifier Units or attempt to remove any of the Amplifier Units during operation.

Other Precautions

Protective Cover

Always keep the protective cover in place when using the Amplifier Unit.

Mobile Console

Use the E3X-MC11-S Mobile Console for the E3X-DA-S-series and the E3X-MDA series Amplifier Units. Other Mobile Consoles, such as the E3X-MC11, cannot be used.

Dimensions

Unit: mm (inch)

Amplifier Units

Amplifier Units with Cables

E3X-MDA11
E3X-MDA41

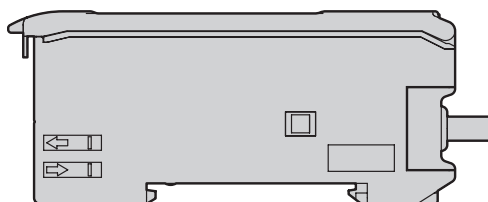
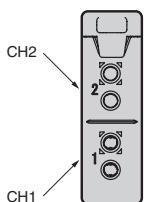
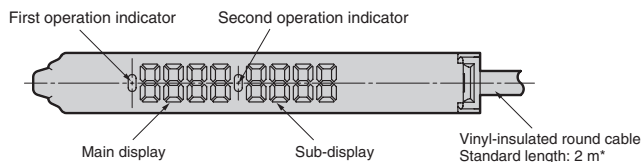

*Cable Specifications

E3X-MDA11	A 4-dia., 2-conductor (conductor cross-sectional area: 0.2 mm ² ; insulation diameter: 1.1 mm)
MDA41	



With Mounting Bracket Attached

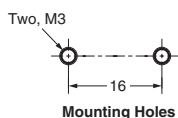
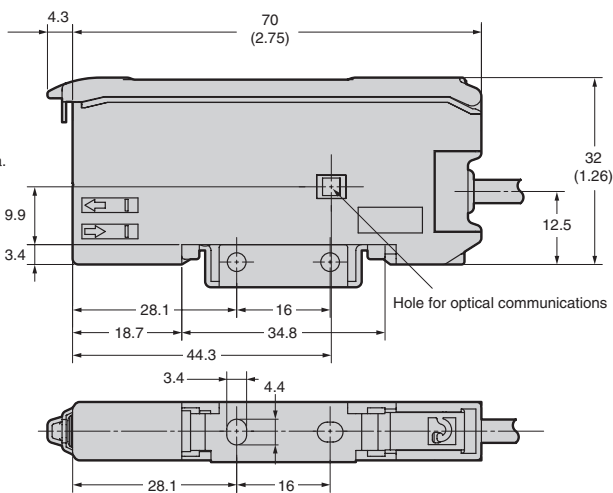
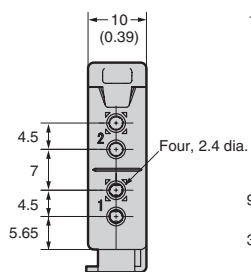
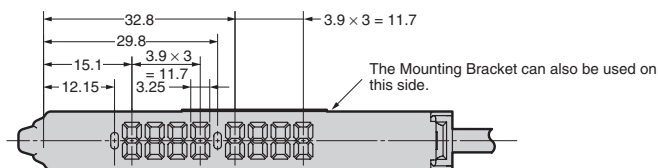

Unit: mm (inch)

Amplifier Units with Connectors

E3X-MDA6
E3X-MDA8

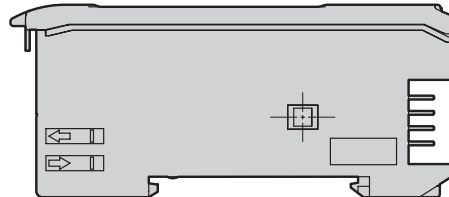
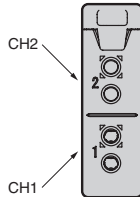
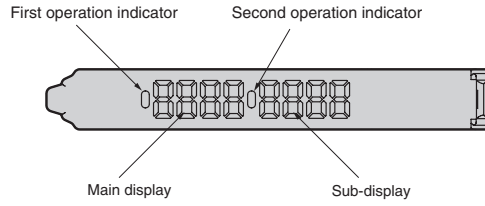

With Mounting Bracket Attached

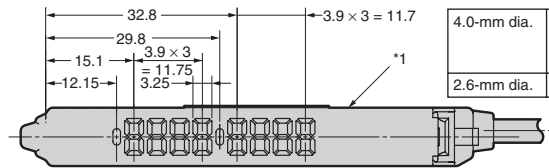

*1 The Mounting Bracket can also be used on this side.

*2 Cable Diameters

4.0-mm dia.	E3X-CN11 (3 conductors)
	E3X-CN21 (4 conductors)
	E3X-CN22 (2 conductors)
2.6-mm dia.	E3X-CN12 (1 conductor)

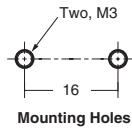
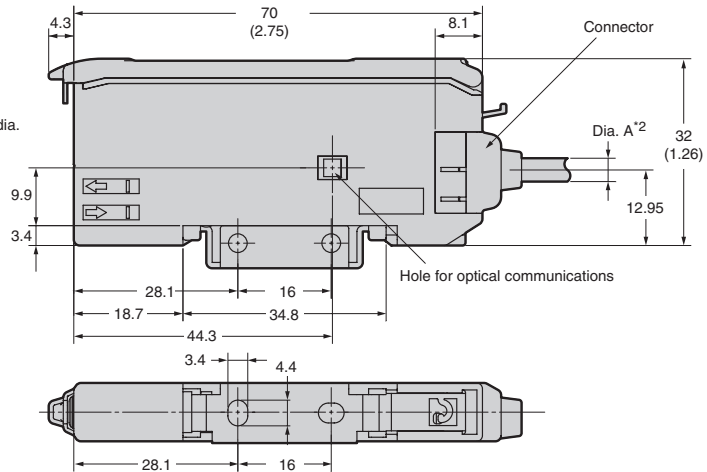
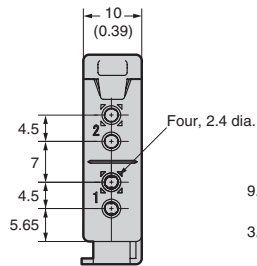

Amplifier Unit Connectors

Master Connectors

E3X-CN11
E3X-CN21

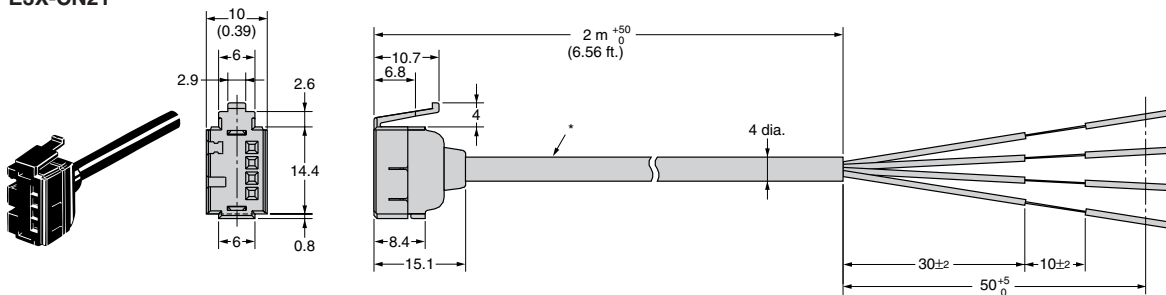

*E3X-CN11: A 4-dia., 3-conductor, vinyl-insulated round cable (conductor cross-sectional area: 0.2 mm²; insulation diameter: 1.1 mm) is used.

E3X-CN21: A 4-dia., 4-conductor, vinyl-insulated round cable (conductor cross-sectional area: 0.2 mm²; insulation diameter: 1.1 mm) is used.

Slave Connectors

E3X-CN12
E3X-CN22

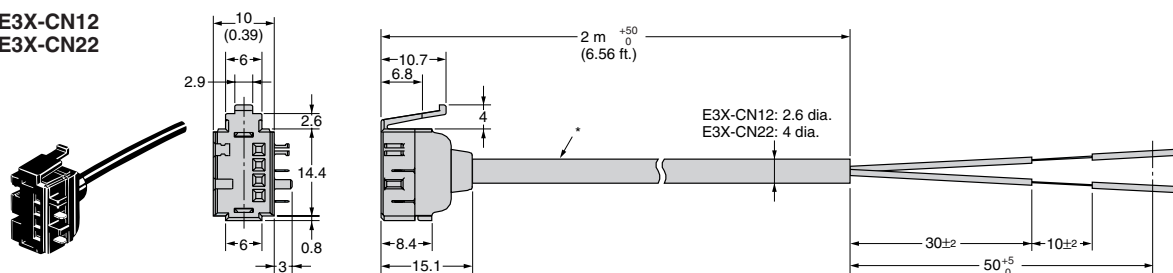

*E3X-CN12: A 2.6-dia., single-conductor, vinyl-insulated round cable (conductor cross-sectional area: 0.2 mm²; insulation diameter: 1.1 mm) is used.

E3X-CN22: A 4-dia., 2-conductor, vinyl-insulated round cable (conductor cross-sectional area: 0.2 mm²; insulation diameter: 1.1 mm) is used.

Mobile Console

E3X-MC11-S

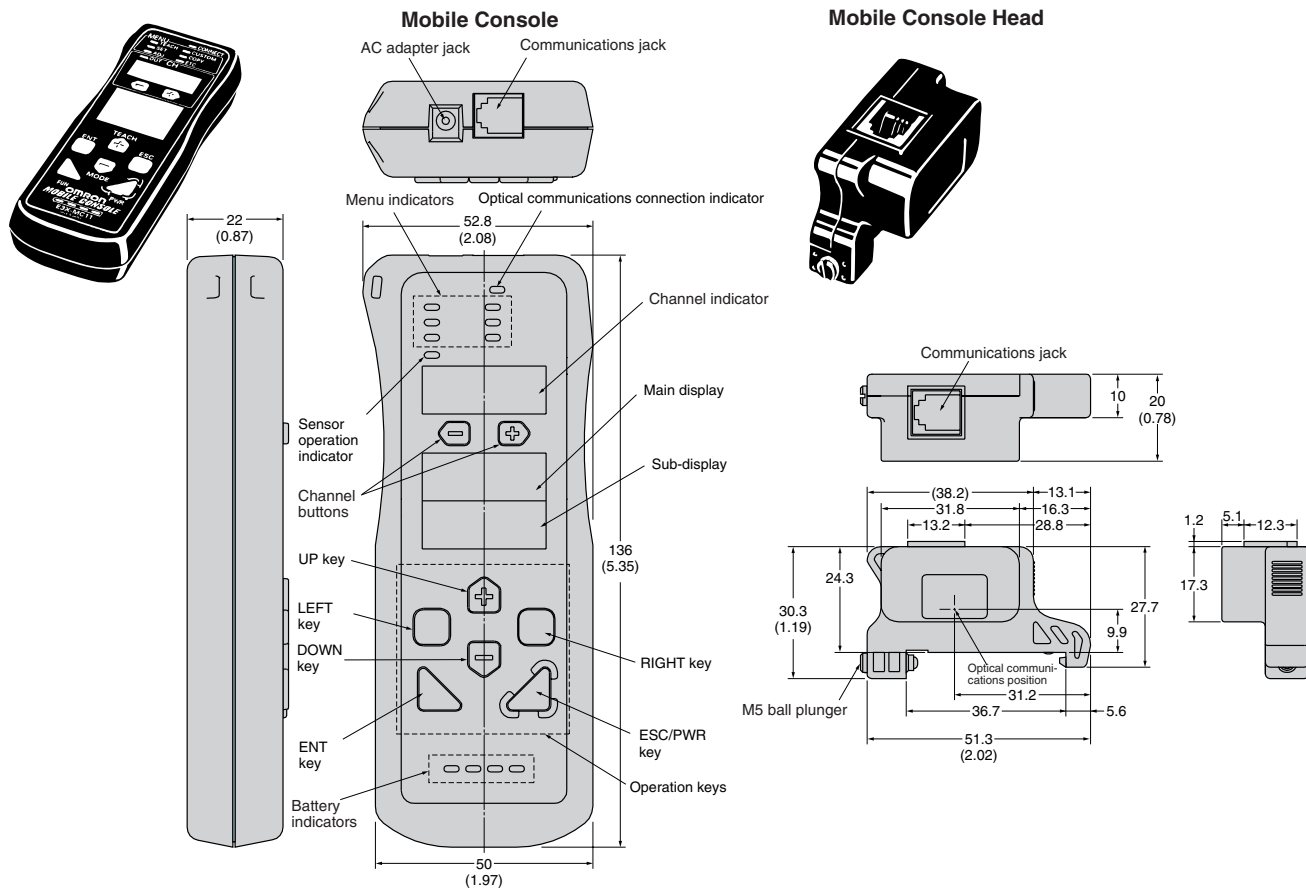

■ Fiber Optic Cables

Unit: mm (inch)

Through-beam Fiber Units (Sold in Pairs)

(Free-cut) Indicates models that allow free cutting. Models without this mark do not allow free cutting.)

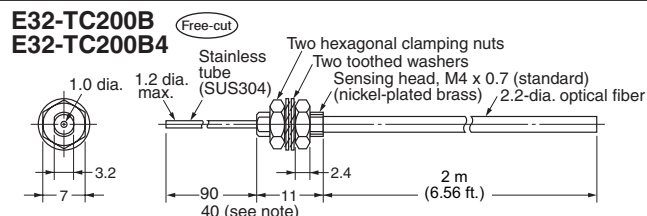
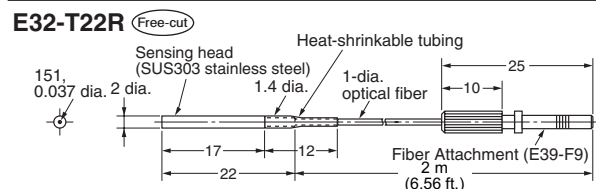
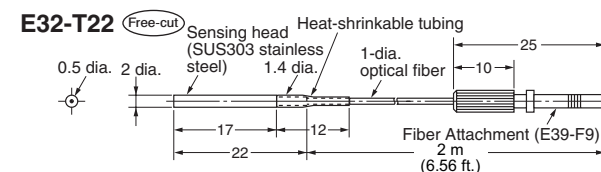
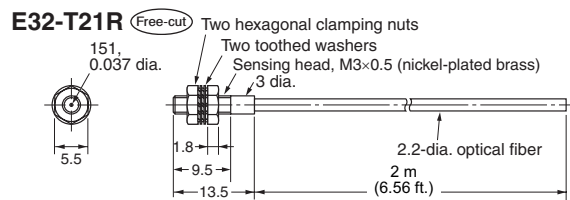
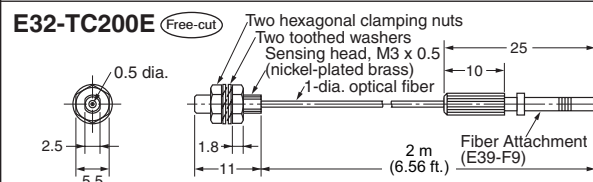
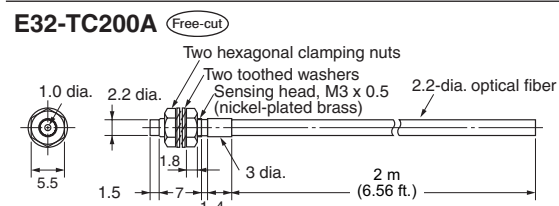
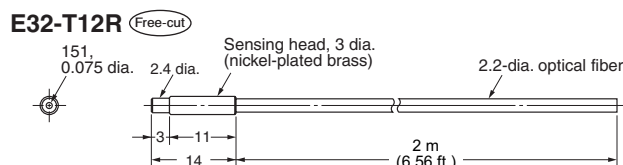
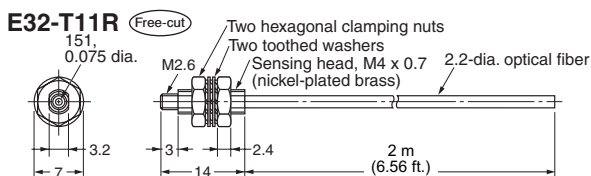
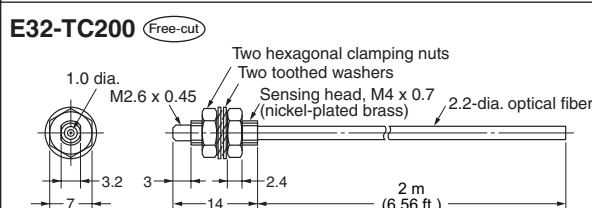
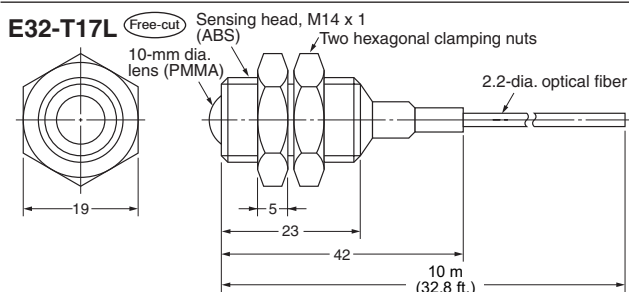
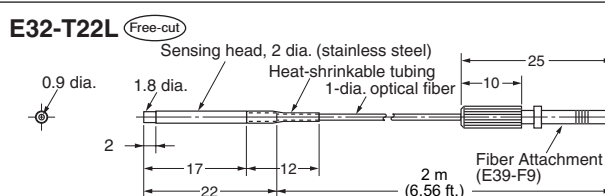
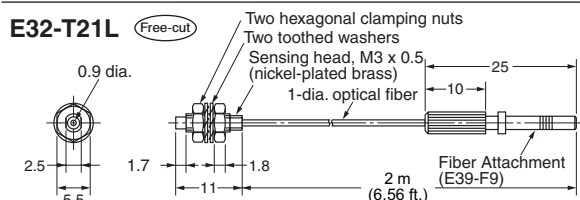
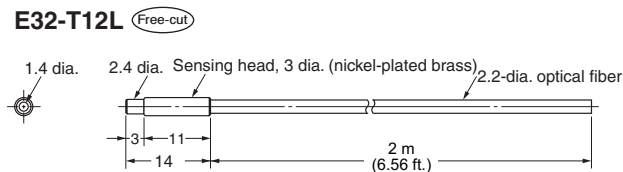
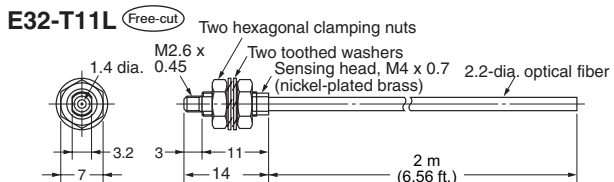

Note: The value in the parentheses is for the E32-TC200B4.

Unit: mm (inch)

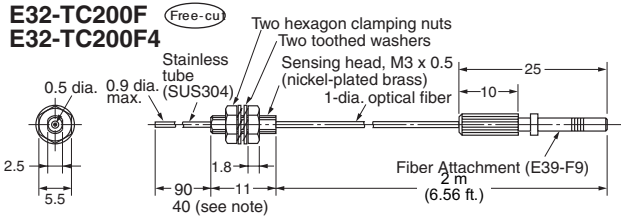

Note: The value in the parentheses is for the E32-TC200F4.

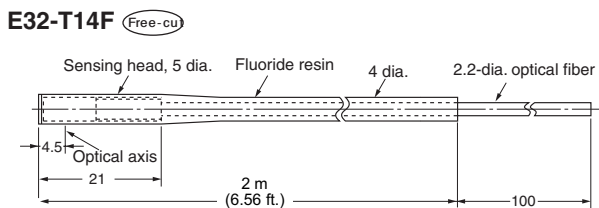
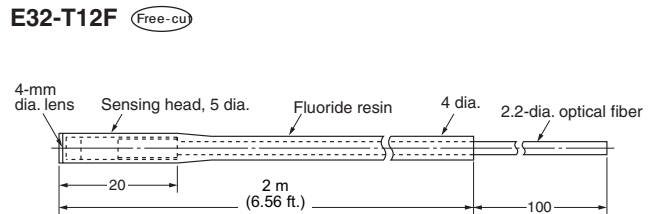
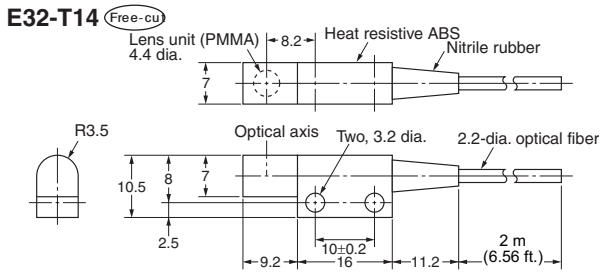
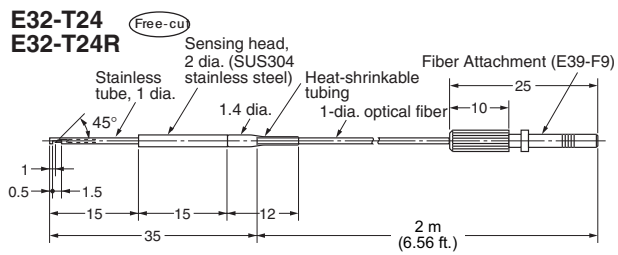
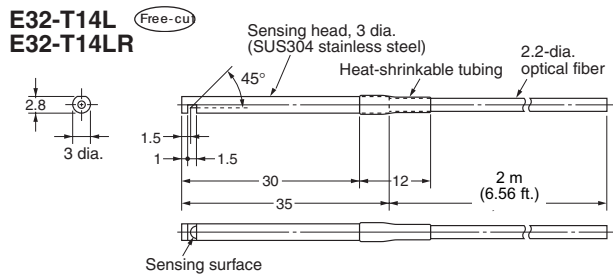
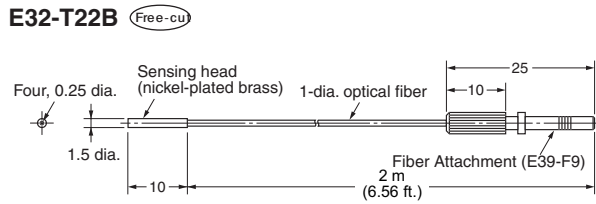
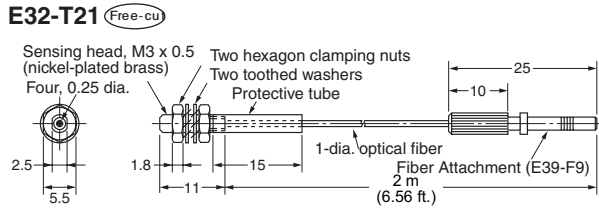
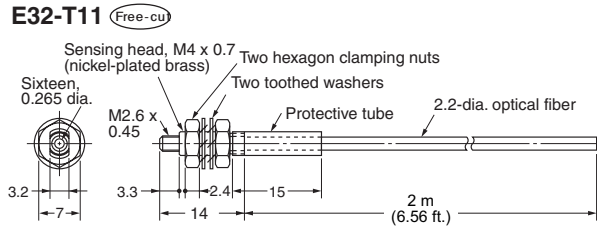

E32-T81F,
E32-T81F-S

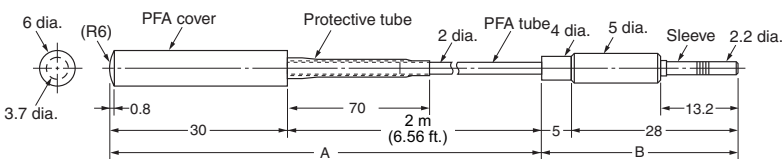

Note: Section A resists 200°C and section B resists 110°C.

E32-T81R,
E32-T81R-S

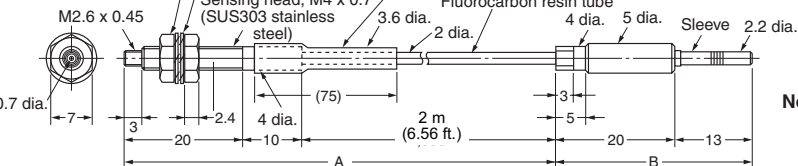

Note: Section A resists 200°C and section B resists 110°C.

E32-T51 (Free-cu)

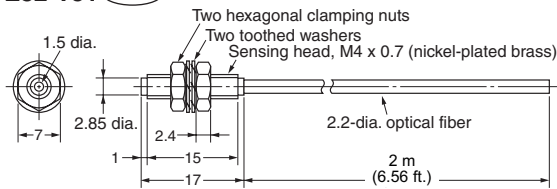

Note: Resistant temperature is 150°C.
Resistant temperature is 130°C when used continuously.

E32-T61, E32T61-S

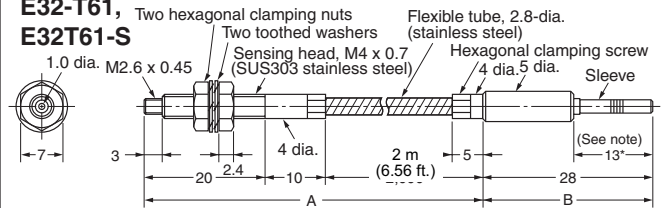

Note: Section A resists 300°C and section B (which is inserted to the Amplifier) resists 110°C.
The operating temperature of the section to be inserted into the Sensor (marked with *) must be within the operating temperature range of the Amplifier.

E32-T54 (Free-cu)

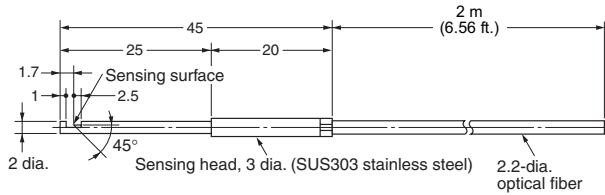

Note: Resistant temperature is 150°C.
Resistant temperature is 130°C when used continuously.

E32-T84S, E32-T84S-S

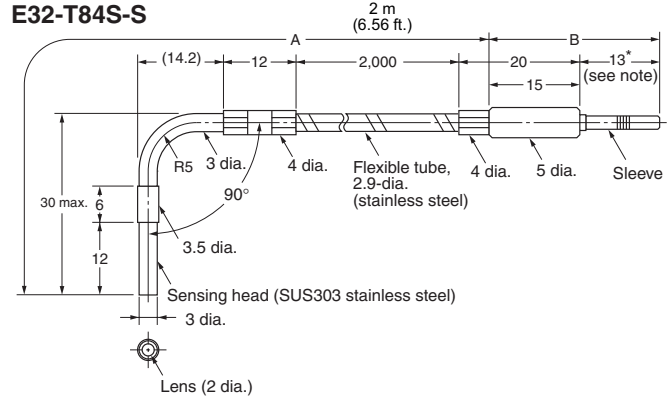

Note: Section A resists 200°C and section B (which is inserted to the Amplifier) resists 110°C.
The operating temperature of section to be inserted into the Sensor (marked with *) must be within the operating temperature range of the Amplifier.

E32-G14 (Free-cu)

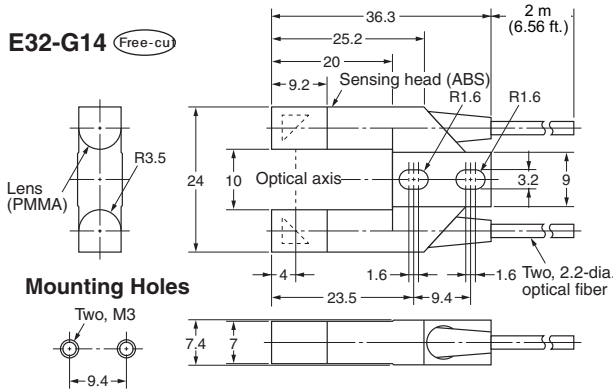

E32-T22S (Free-cu)

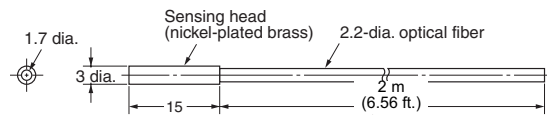

E32-T24S (Free-cu)

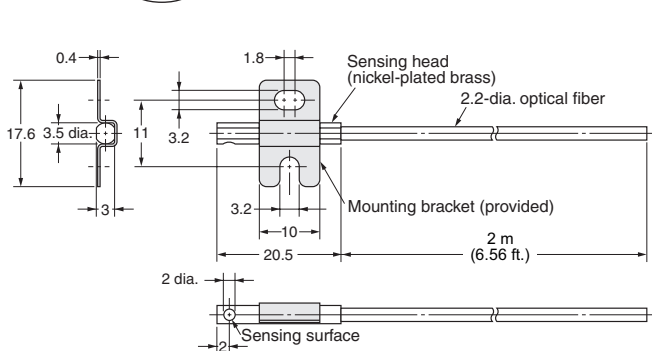

E32-M21

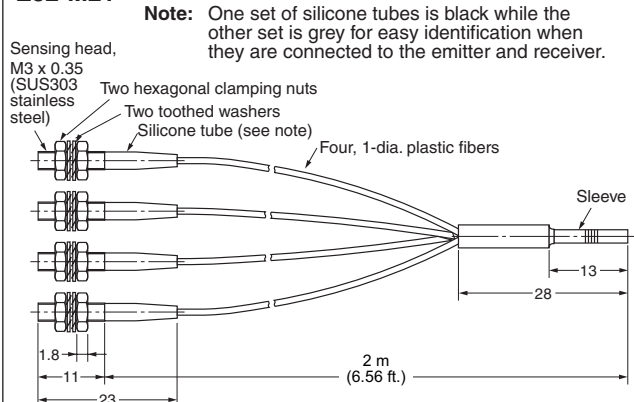

Note: One set of silicone tubes is black while the other set is grey for easy identification when they are connected to the emitter and receiver.

Unit: mm (inch)

E32-T16W
E32-T16WR

(Free-cut)

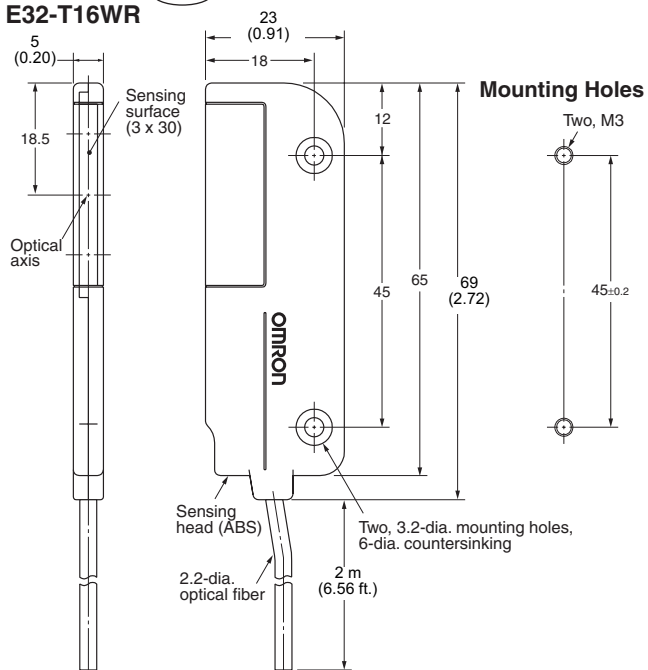

E32-T16J
E32-T16JR

(Free-cut)

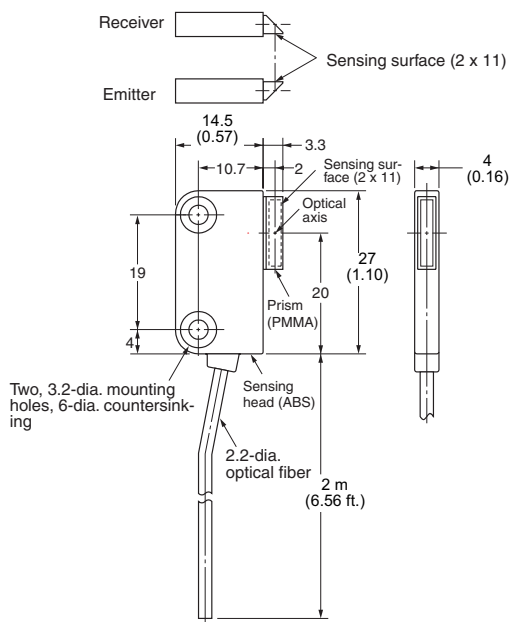

E32-T16

(Free-cut)

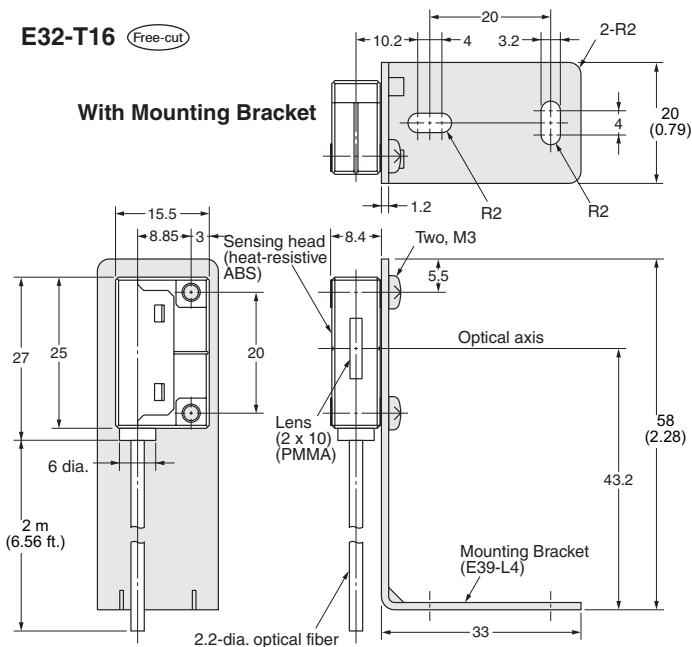

Mounting Holes

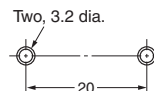

0.5-mm-wide Slit Seal
(Supplied with the Unit in Pairs)

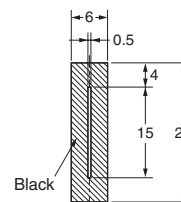

1-mm-wide Slit Seal
(Supplied with the Unit in Pairs)

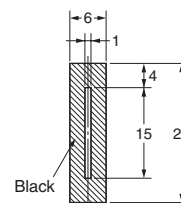

E32-T16P (Free-cut)
E32-T16PR

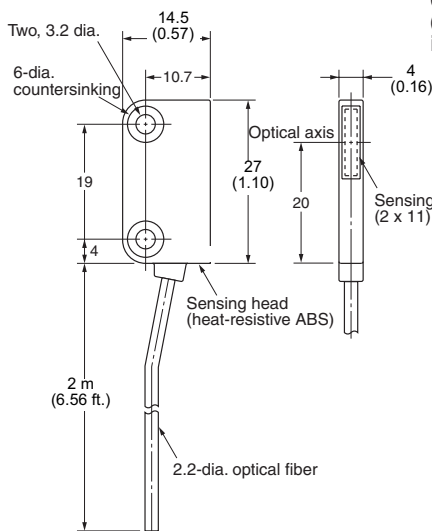

0.5-mm-wide Slit Seal
 (Supplied with the Unit in Pairs)

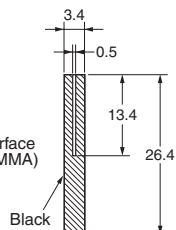

1-mm-wide Slit Seal
 (Supplied with the Unit in Pairs)

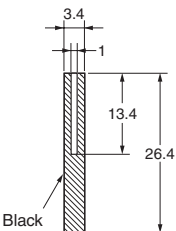

With Mounting Bracket

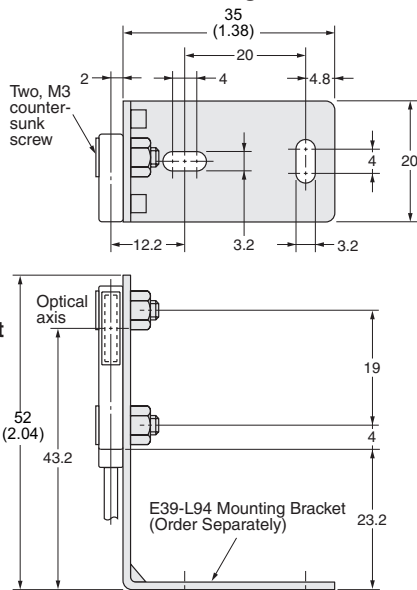

Mounting Holes

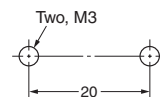

E32-T11F (Free-cut)

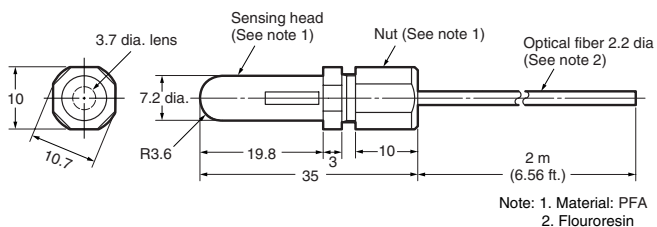

E32-T11U (Free-cut)

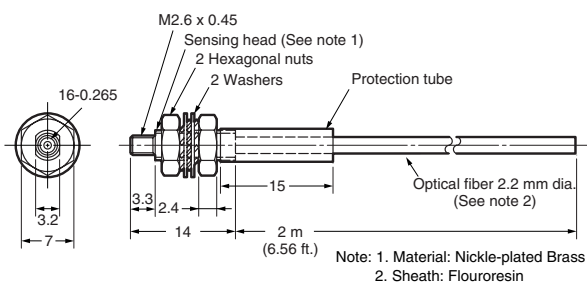

Diffuse Fiber Units

Unit: mm (inch)

Free-cut Indicates models that allow free cutting. Models without this mark do not allow free cutting.

E32-D11L **Free-cut**

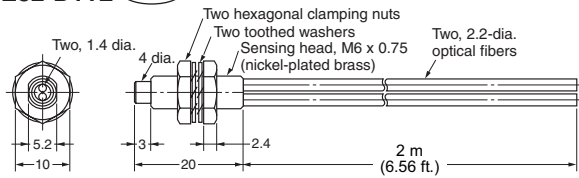

E32-D12 **Free-cut**

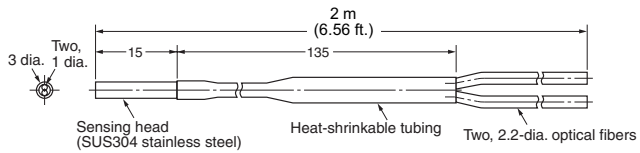

E32-D21L **Free-cut**

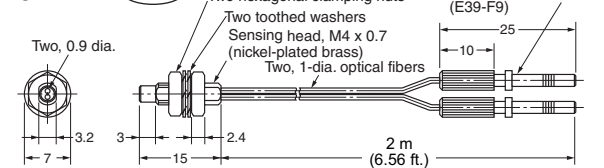

E32-D22L **Free-cut**

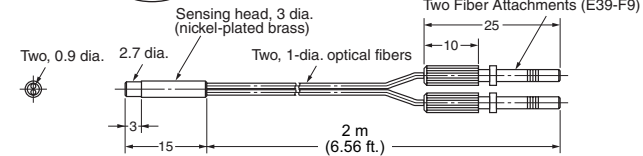

E32-DC200 **Free-cut**

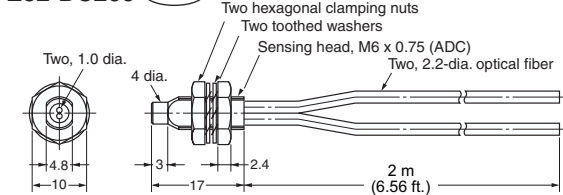

E32-D11R **Free-cut**

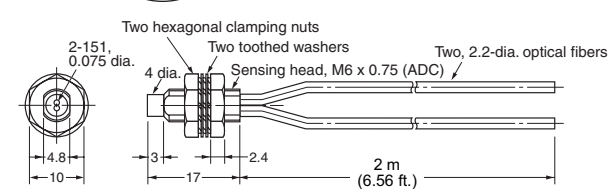

E32-D12R **Free-cut**

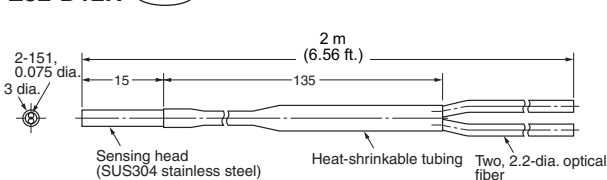

E32-DC200E **Free-cut**

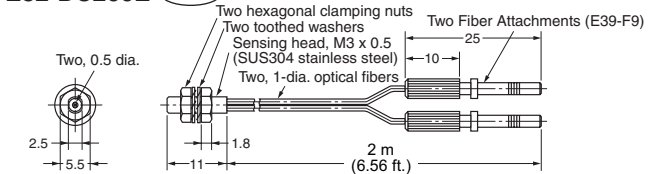

E32-D21R **Free-cut**

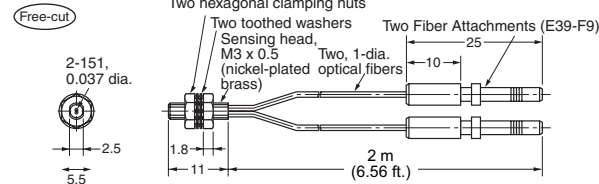

E32-D22R **Free-cut**

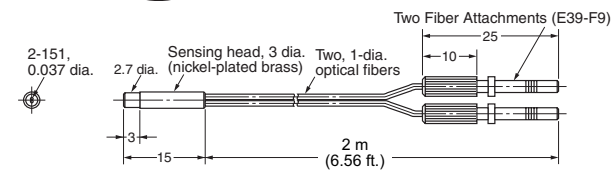

E32-DC200B **Free-cut**
E32-DC200B4

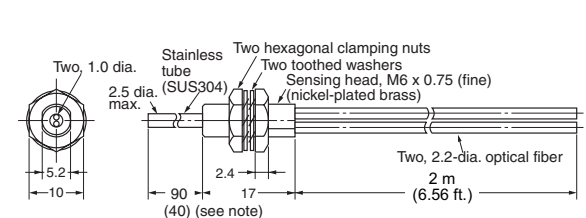

Note: The value in the parentheses is for the E32-DC200B4.

E32-DC200F **Free-cut**
E32-DC200F4

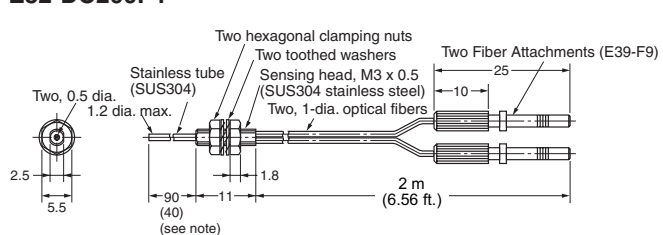

Note: The value in the parentheses is for the E32-DC200F4.

E32-D33 (Free-cut)

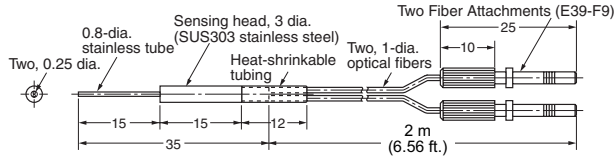

E32-D331

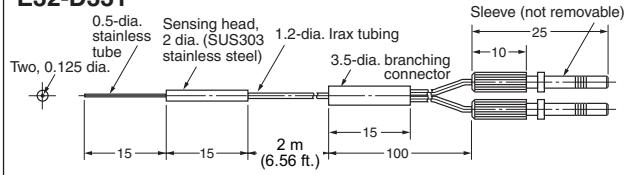

E32-D11 (Free-cut)

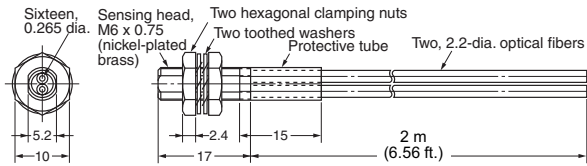

E32-D21 (Free-cut)

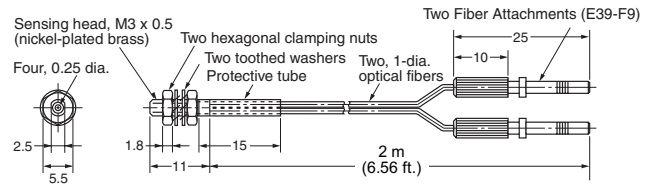

E32-D21B (Free-cut)

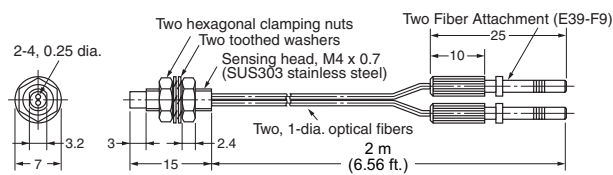

E32-D22B

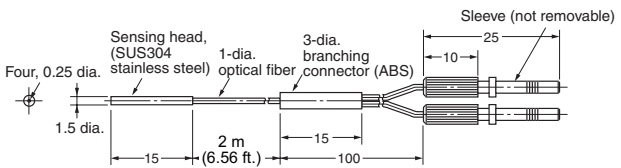

E32-CC200 (Free-cut)

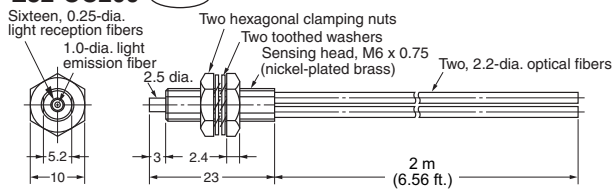

E32-D32L (Free-cut)

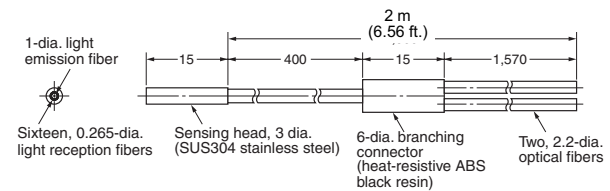

Note: The fiber for the emitter is identified by a white line.

Note: The fiber for the emitter is identified by a yellow dotted line.

E32-C31 (Free-cut)

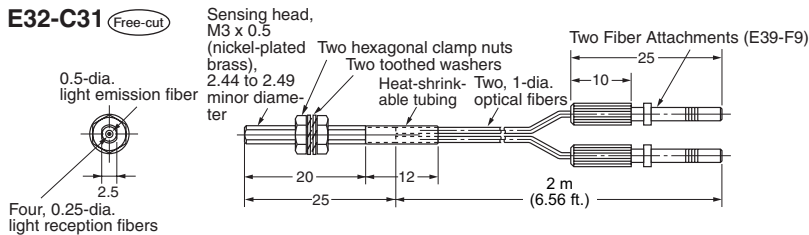

Note: The fiber for the emitter is identified by a white line.

E32-C41

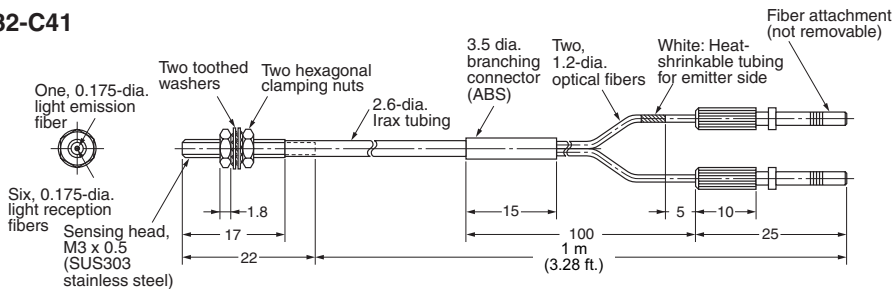

Unit: mm (inch)

E32-C42

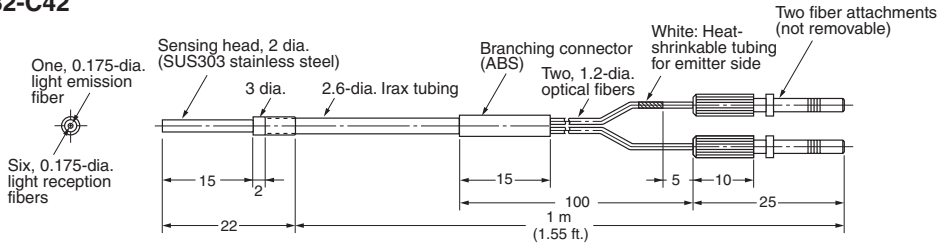

E32-D32 (Free-cu)

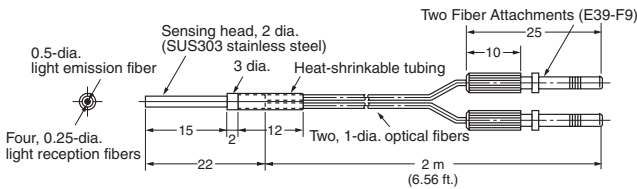

Note: The fiber for the emitter is identified by a white line.

E32-D14L (Free-cu)
E32-D14LR

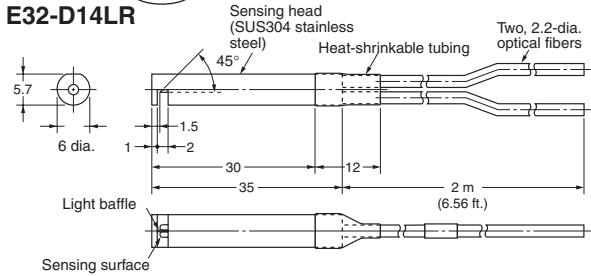

E32-D24 (Free-cu)
E32-D24R

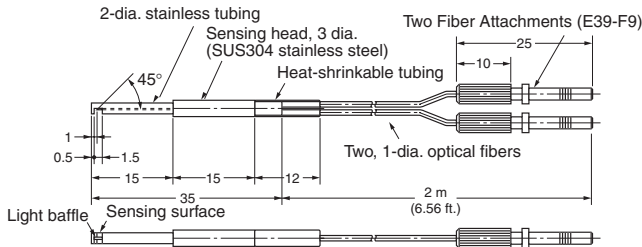

E32-D12F (Free-cu)

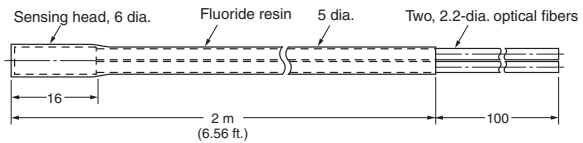

E32-D51 (Free-cu)

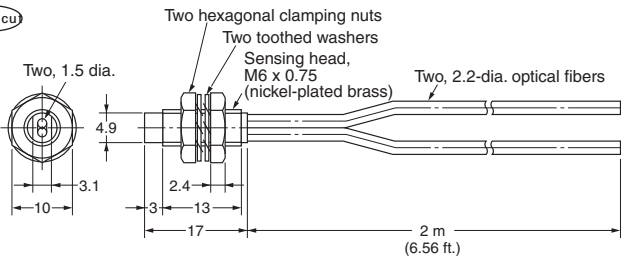

Note: Resistant temperature is 150°C.
Resistant temperature is 130°C when used continuously.

E32-D61
E32-D61-S

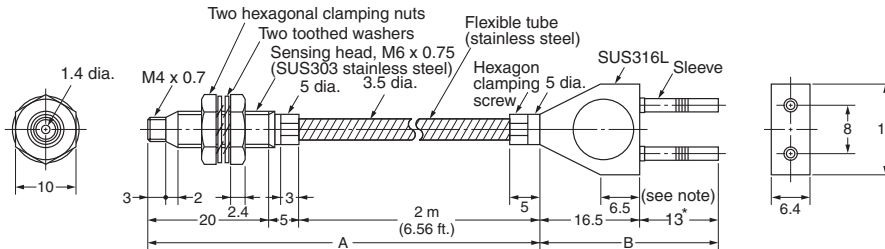

Note: Section A resists 300°C and section B (which is inserted to the Amplifier) resists 110°C. The operating temperature of the section to be inserted into the Sensor (marked with *) must be within the operating temperature range of the Amplifier.

**E32-D73,
E32-D73-S**

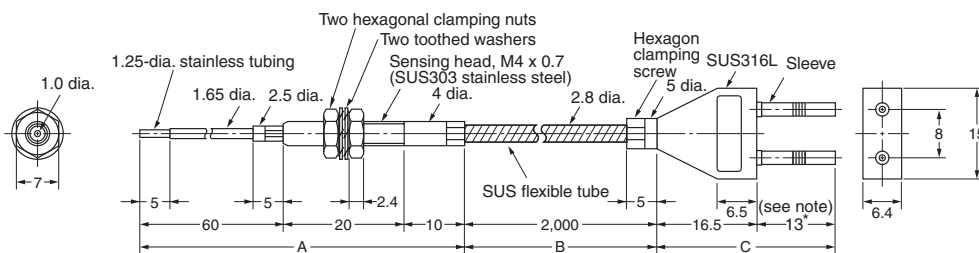

Note: Section A resists 400°C, section B resists 300°C, and section C (which is inserted to the Amplifier) resists 110°C. The operating temperature of the section to be inserted into the Sensor (marked with *) must be within the operating temperature range of the Amplifier.

E32-D36P1 (Free-cut)

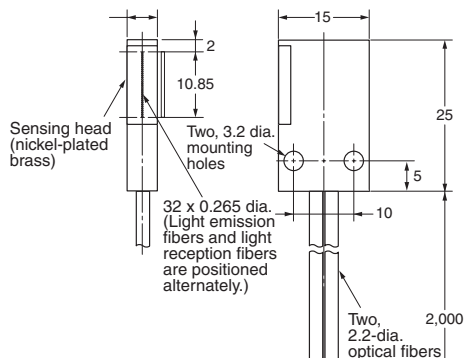

Mounting Holes

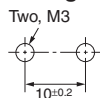

E32-R21 (Free-cut)

(One E39-R3 Reflector is Supplied with the Sensor)

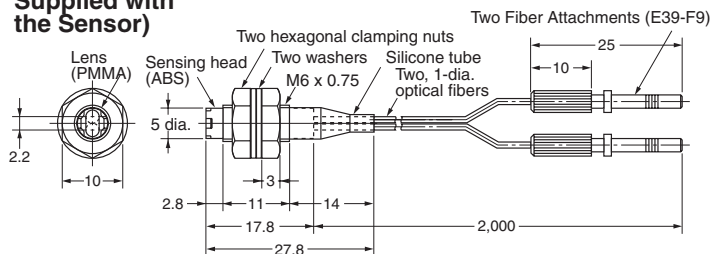

E32-R16 (Free-cut)

(One E39-R1 Reflector is Supplied with the Sensor)

With Mounting Bracket

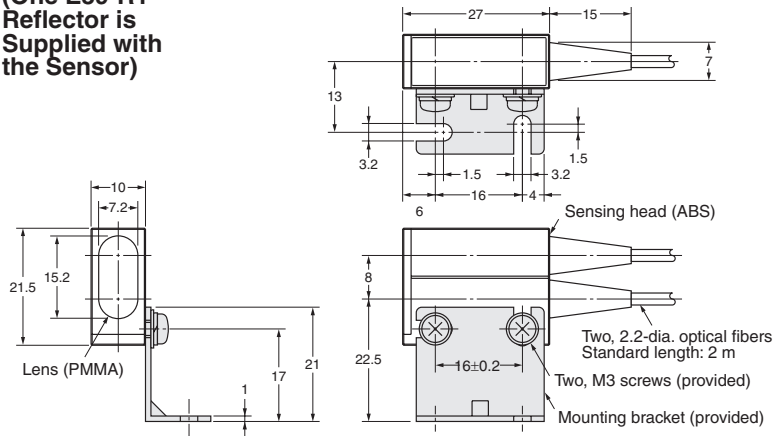

E32-L56E1 (Free-cut)
E32-L56E2

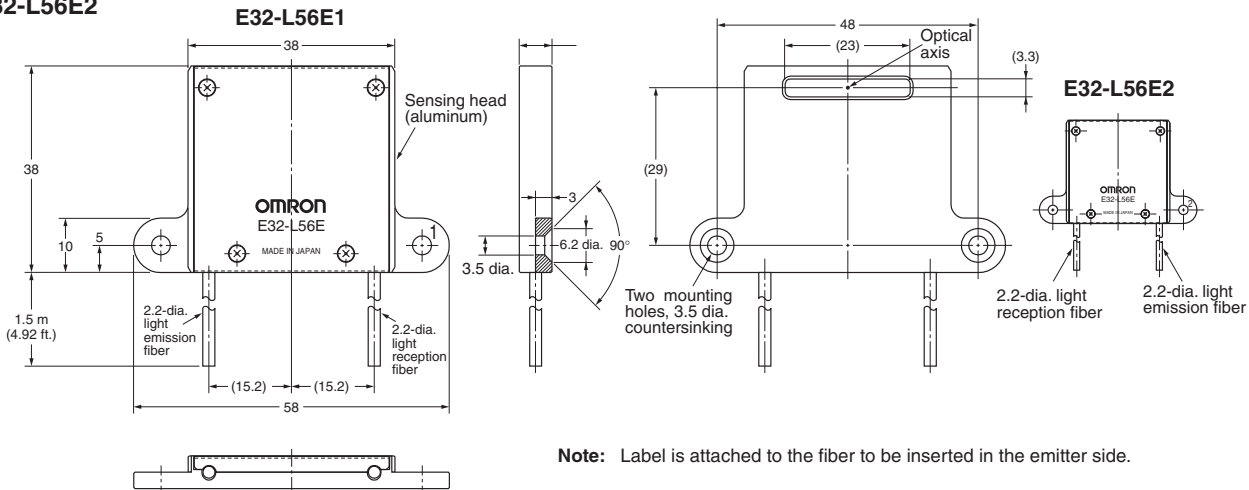

Note: Label is attached to the fiber to be inserted in the emitter side.

Unit: mm (inch)

E32-L24L (Free-cut)

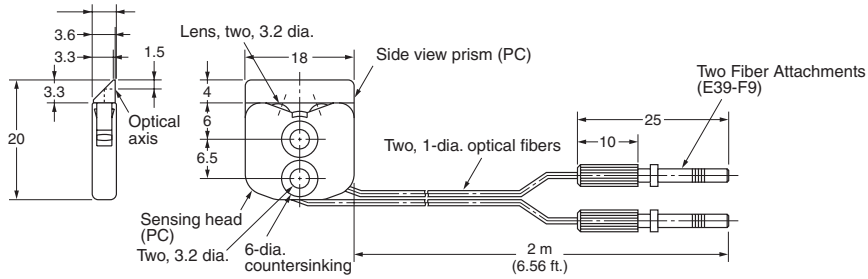

E32-L25L (Free-cut)

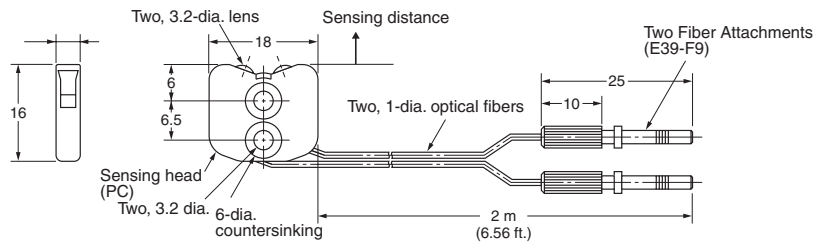

E32-L25 (Free-cut)

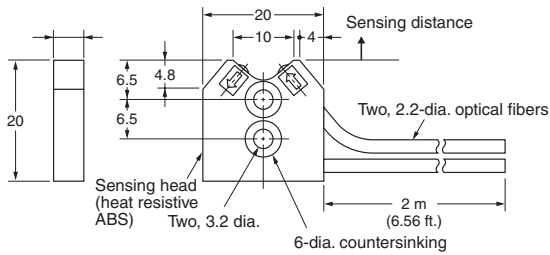

E32-L25A (Free-cut)

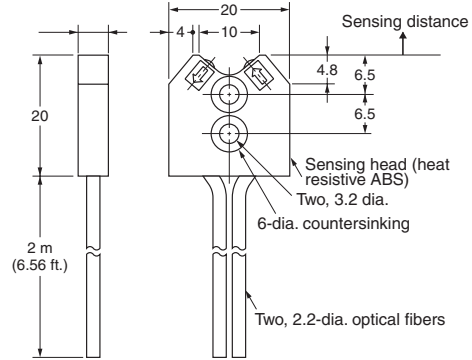

Note: The fiber for the emitter is identified by a white line.

Note: The fiber for the emitter is identified by a white line.

E32-D16 (Free-cut)

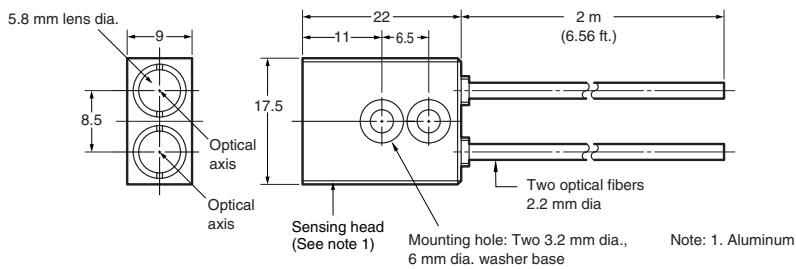

Note: 1. Aluminum

E32-D11U (Free-cut)

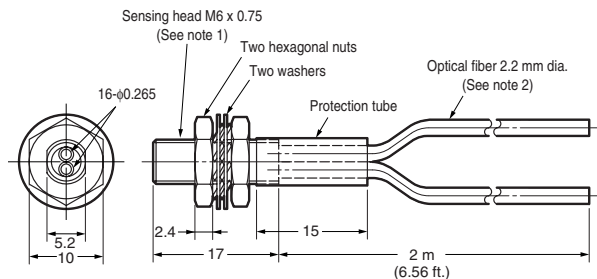

Note: 1. Nickel plated brass
2. Fluoresin

E32-D81R
E32-D81R-S

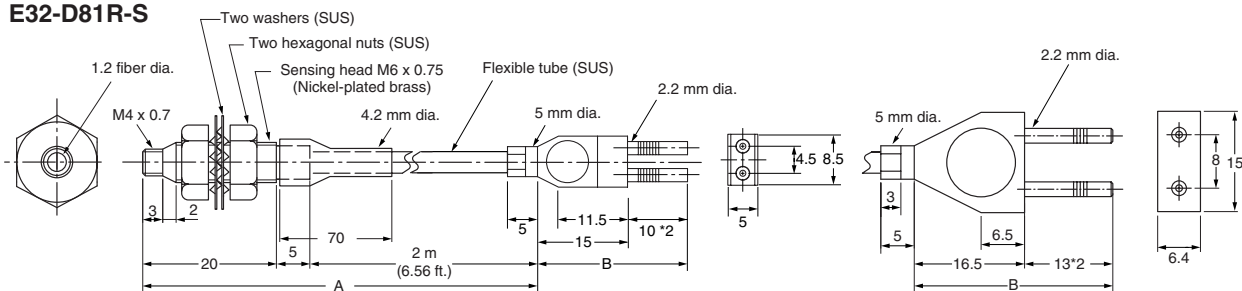

Note: Section "A" can resist temperatures to 200°C; section "B" can resist temperatures to 110°C.

E32-L16 (Free-cut)

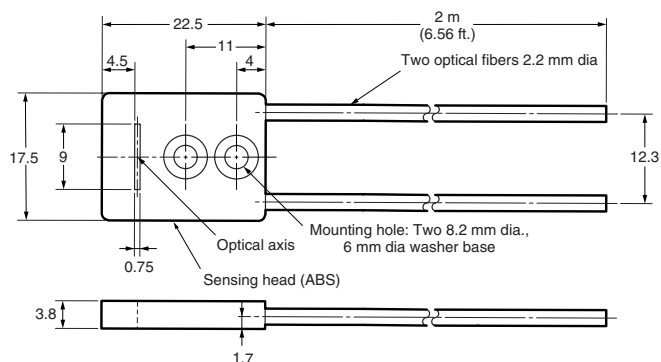

E32-L66

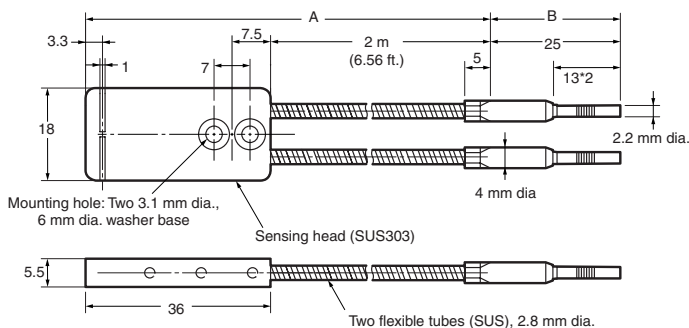

Note: Section "A" resists temperatures to 300°C; section "B" resists temperatures to 110°C

E32-L24S (Free-cut)

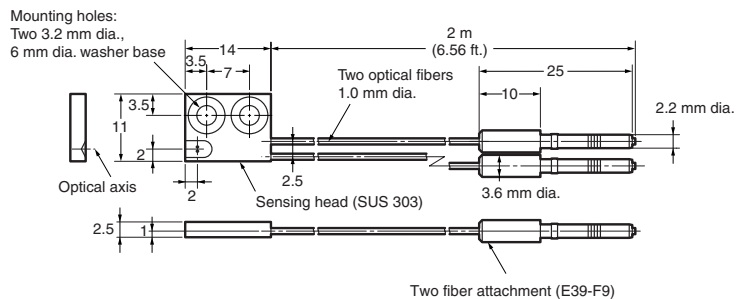

Unit: mm (inch)

E32-A01 (Free-cut)

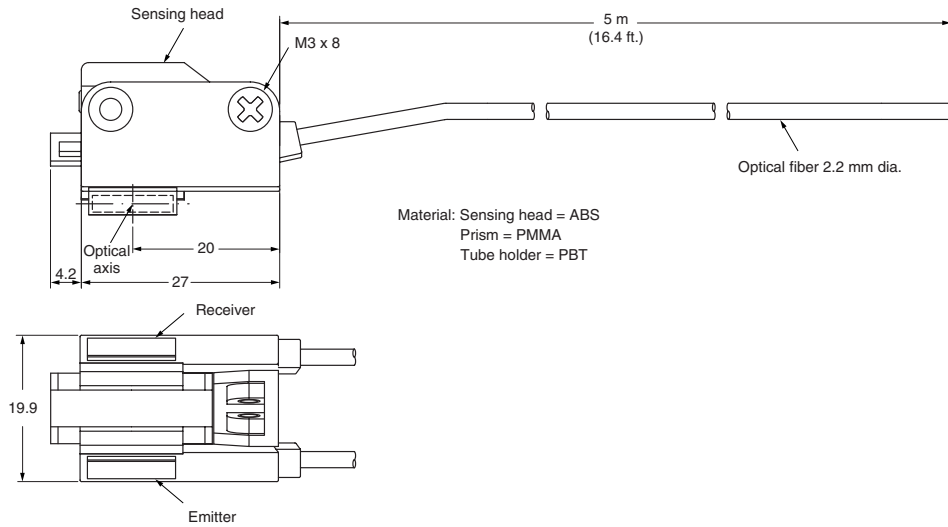
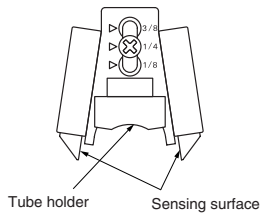

E32-A02 (Free-cut)

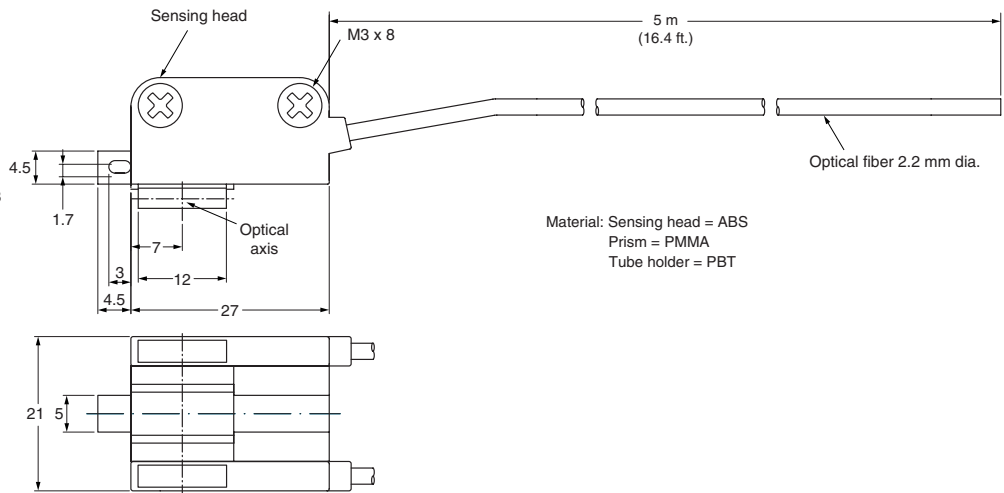
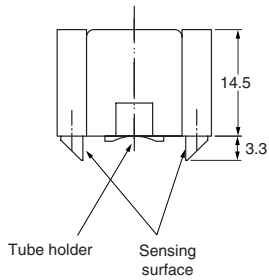

E32-D36F (Free-cut)

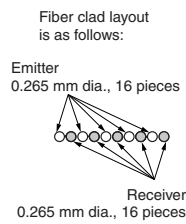
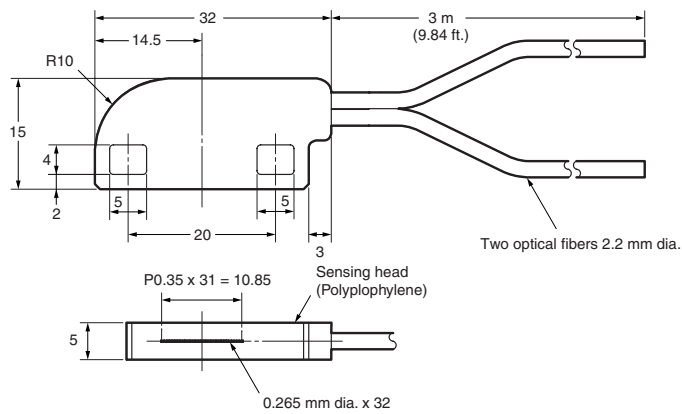

E32-A03 (Free-cut)

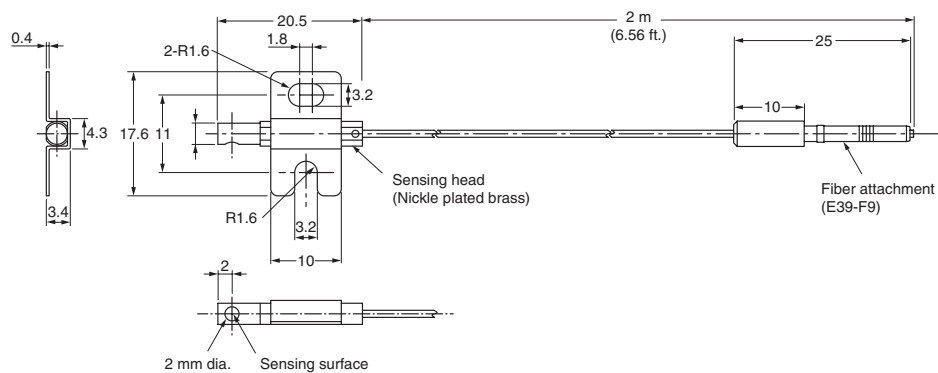

E32-A04 (Free-cut)

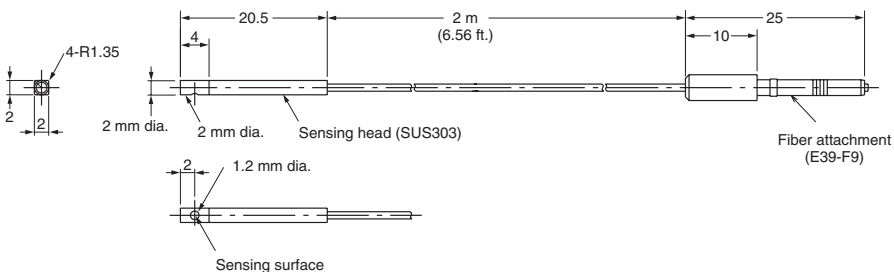

Accessories (Order Separately)

Reflectors

Reflector E39-R1



Material:
Reflective surface:
acrylic
Back: ABS

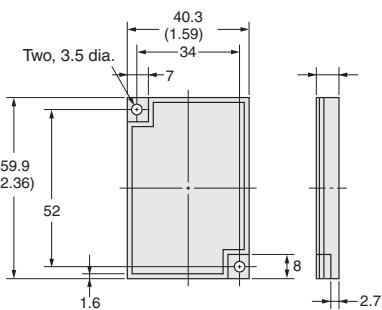

Reflector (Miniature) E39-R3



Material:
Reflective surface:
acrylic
Back: ABS

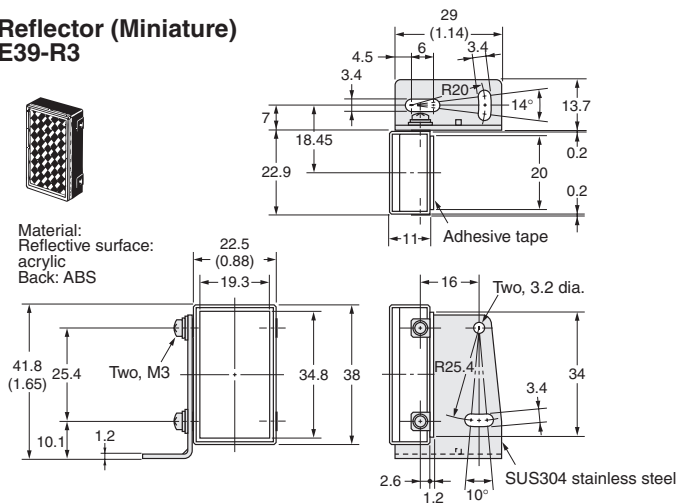

Unit: mm (inch)

E39-L4

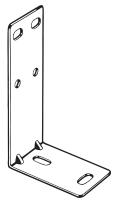

Material: iron

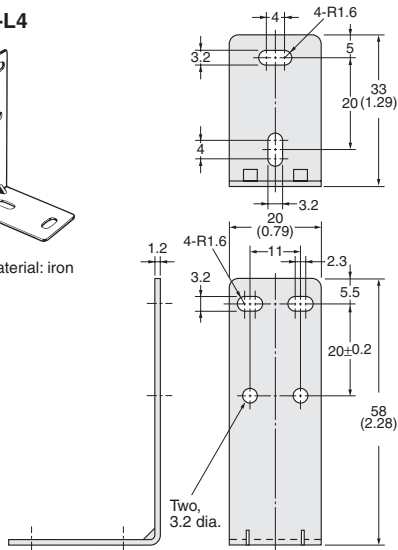

E39-L94

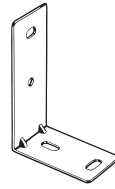

Material: iron

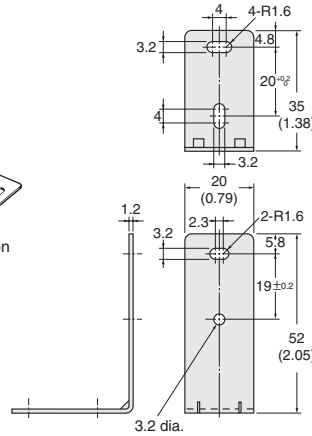

Lens Units

E39-F1 Long Distance Lens Unit



Material: Tube: Brass
Lens: Optical glass

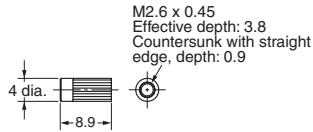

Note: One set includes two units.

E39-F2 Side-view Unit



Material: Tube: Brass
Lens: Optical glass

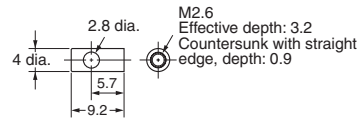

Note: One set includes two units.

E39-F3 Lens-equipped Reflective Unit

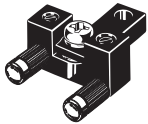

Material: Tube: Brass
Base: Aluminum

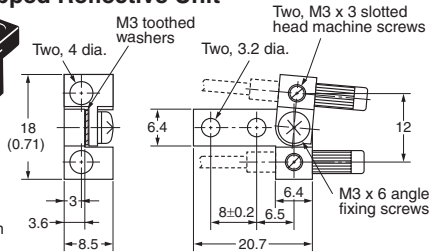

Note: Fix the fiber head using the slotted head machine screw. Do not insert the E39-F1 Lens.

E39-F5 Side-view Reflective Unit

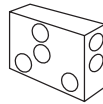

Material: Base: Brass
Reflector: Stainless steel

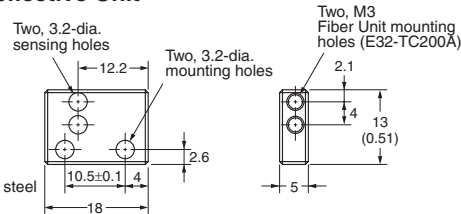

Note: Only E32-TC200A can be mounted. When mounting, remove all of the accompanying screws first and then screw the E32-TC200A into the E39-F5 until the stopper comes into contact.

E39-F3A Small Spot Lens Unit

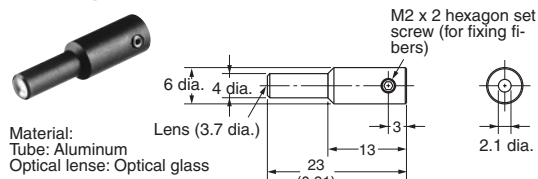

Material: Tube: Aluminum
Optical lens: Optical glass

Note: E39-F3A is a Lens Unit for the E32-D32 and E32-C42.

E39-F3A-5 Small Spot Lens Unit

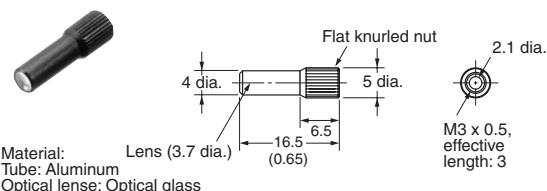

Material: Tube: Aluminum
Optical lens: Optical glass

Note: E39-F3A-5 is a Lens Unit for the E32-C31 and E32-C41.

E39-F3B Small Spot Lens Unit

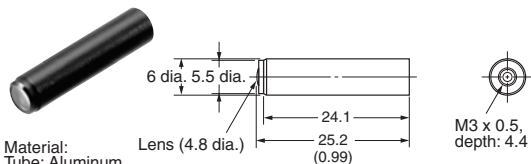

Material: Tube: Aluminum
Optical lens: Optical glass

Note: E39-F3B is a Lens Unit for the E32-C31 and E32-C41.

E39-F3C Small Spot Lens Unit

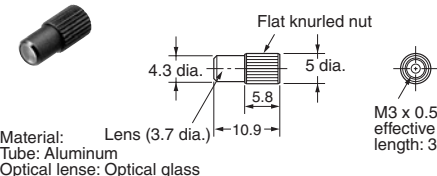

Material: Tube: Aluminum
Optical lens: Optical glass

Note: E39-F3C is a Lens Unit for the E32-C31 and E32-C41.

E39-F32A, E39-F32A5 E39-F32B, E39-F32B5

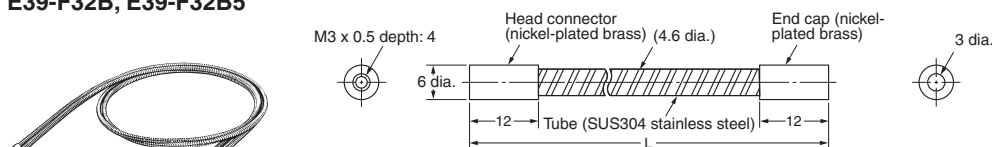

Note: 1. L is as follows:
E39-F32A and E39-F32B: 1m (3.28 ft)
E39-F32A5, E39-F32B5: .5m (1.64 ft)
2. A pair of E39-F32A(5)'s is sold as E39-F32B(5).

E39-F32C, E39-F32C5

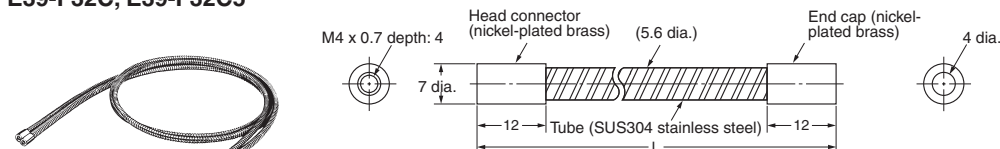

Note: L is as follows:
E39-F32C: 1m (3.28 ft)
E39-F32C5: .5m (1.64 ft)

E39-F32D, E39-F32D5

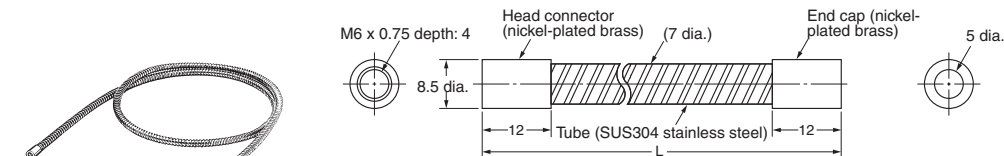

Note: L is as follows:
E39-F32D: 1m (3.28 ft)
E39-F32D5: .5m (1.64 ft)

Unit: mm (inch)

Other Accessories

E39-F4 Fiber Cutter

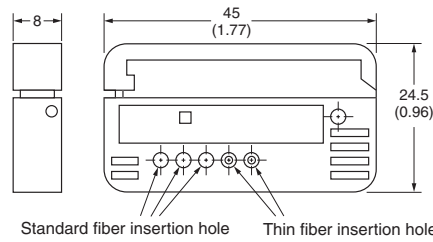
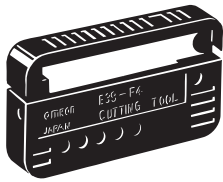

E39-F9 Attachment for Thin Fiber

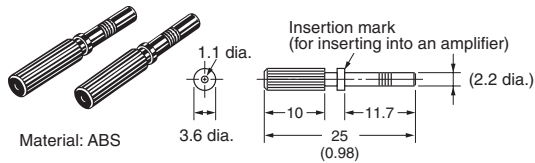

Material: ABS

Note: One set includes two units. Included with Thin Fiber Unit.

E39-F10 Fiber Connector

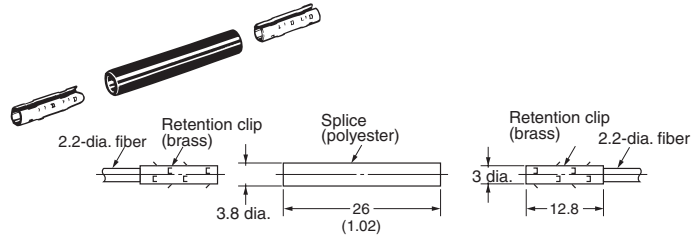

E39-F11 Sleeve Bender

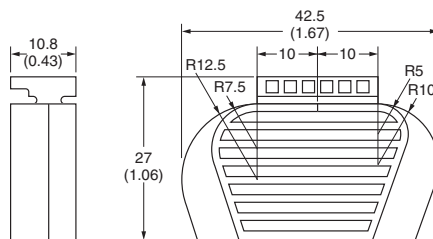

E39-K2 Protective Attachment



Material: ABS

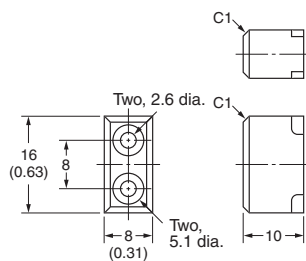

Application Example

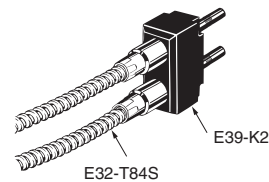

Terms and Conditions

WARRANTY, LIMITATIONS OF LIABILITY

WARRANTY OMRON's exclusive warranty is that the products are free from defects in materials and workmanship for a period of three years (or other period if specified) from date of sale by OMRON.

OMRON MAKES NO WARRANTY OR REPRESENTATION, EXPRESS OR IMPLIED, REGARDING NON-INFRINGEMENT, MERCHANTABILITY OR FITNESS FOR PARTICULAR PURPOSE OF THE PRODUCTS. ANY BUYER OR USER ACKNOWLEDGES THAT IT ALONE HAS DETERMINED THAT THE PRODUCTS WILL SUITABLY MEET THE REQUIREMENTS OF THEIR INTENDED USE. OMRON DISCLAIMS ALL OTHER WARRANTIES, EXPRESS OR IMPLIED.

LIMITATIONS OF LIABILITY OMRON SHALL NOT BE RESPONSIBLE FOR SPECIAL, INDIRECT OR CONSEQUENTIAL DAMAGES, LOSS OF PROFITS OR COMMERCIAL LOSS IN ANY WAY CONNECTED WITH THE PRODUCTS, WHETHER SUCH CLAIM IS BASED ON CONTRACT, WARRANTY, NEGLIGENCE OR STRICT LIABILITY.

In no event shall responsibility of OMRON for any act exceed the individual price of the product on which liability is asserted.

IN NO EVENT SHALL OMRON BE RESPONSIBLE FOR WARRANTY, REPAIR OR OTHER CLAIMS REGARDING THE PRODUCTS UNLESS OMRON'S ANALYSIS CONFIRMS THAT THE PRODUCTS WERE PROPERLY HANDLED, STORED, INSTALLED AND MAINTAINED AND NOT SUBJECT TO CONTAMINATION, ABUSE, MISUSE, OR INAPPROPRIATE MODIFICATION OR REPAIR.

APPLICATION CONSIDERATIONS

SUITABILITY FOR USE OMRON shall not be responsible for conformity with any standards, codes or regulations which apply to the combination of the product in the customer's application or use of the product.

At the customer's request, OMRON will provide applicable third party certification documents identifying ratings and limitations of use which apply to the product. This information by itself is not sufficient for a complete determination of the suitability of the product in combination with the end product, machine, system, or other application or use.

The following are some examples of applications for which particular attention must be given. This is not intended to be an exhaustive list

of all possible uses of this product, nor is it intended to imply that the uses listed may be suitable for this product:

- Outdoor use, uses involving potential chemical contamination or electrical interference, or conditions or uses not described in this catalog.
- Nuclear energy control systems, combustion systems, railroad systems, aviation systems, medical equipment, amusement machines, vehicles, safety equipment, and installations subject to separate industry or government regulations.
- Systems, machines and equipment that could present a risk to life or property.

Please know and observe all prohibitions of use applicable to this product.

NEVER USE THE PRODUCT FOR AN APPLICATION INVOLVING SERIOUS RISK TO LIFE OR PROPERTY WITHOUT ENSURING THAT THE SYSTEM AS A WHOLE HAS BEEN DESIGNED TO ADDRESS THE RISKS, AND THAT THE OMRON PRODUCT IS PROPERLY RATED AND INSTALLED FOR THE INTENDED USE WITHIN THE OVERALL EQUIPMENT OR SYSTEM.

PROGRAMMABLE PRODUCTS OMRON shall not be responsible for the user's programming of a programmable product, or any consequence thereof.

DISCLAIMERS

PERFORMANCE DATA Performance data given in this catalog is provided as a guide for the user in determining suitability and does not constitute a warranty. It may represent the result of OMRON's test conditions, and the user must correlate it to actual application requirements. Actual performance is subject to the OMRON Warranty and Limitations of Liability.

CHANGE IN SPECIFICATIONS Product specifications and accessories may be changed at any time based on improvements and other reasons. It is our practice to change part numbers when published ratings or features are changed, or when significant construction changes are made. However, some specifications of the product may be changed without any notice. When in doubt, special part numbers may be assigned to fix or establish key specifications for your application. Please consult with your OMRON representative at any time to confirm actual specifications of purchased product.

ERRORS AND OMISSIONS The information in this catalog has been carefully checked and is believed to be accurate; however, no responsibility is assumed for clerical, typographical or proofreading errors, or omissions.

Complete terms and conditions for product usage are on Omron's website at www.omron.com/oei -- under the "About Us" tab, under the Legal Matters heading.

ALL DIMENSIONS SHOWN ARE IN MILLIMETERS. To convert millimeters into inches, divide by 25.4

OMRON

OMRON ELECTRONICS LLC

One Commerce Drive
Schaumburg, IL 60173

847-843-7900

For US technical support or other inquiries:

800-556-6766

OMRON CANADA, INC.

885 Milner Avenue
Toronto, Ontario M1B 5V8

416-286-6465

OMRON ON-LINE

Global - <http://www.omron.com>
USA - <http://www.omron.com/oei>
Canada - <http://www.omron.ca>