

# QSE156, QSE157, QSE158, QSE159 QSE156C, QSE157C, QSE158C, QSE159C Plastic Silicon OPTOLOGIC® Photosensor

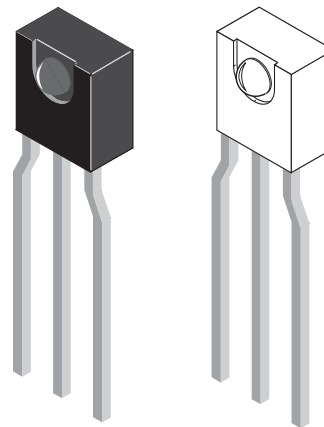
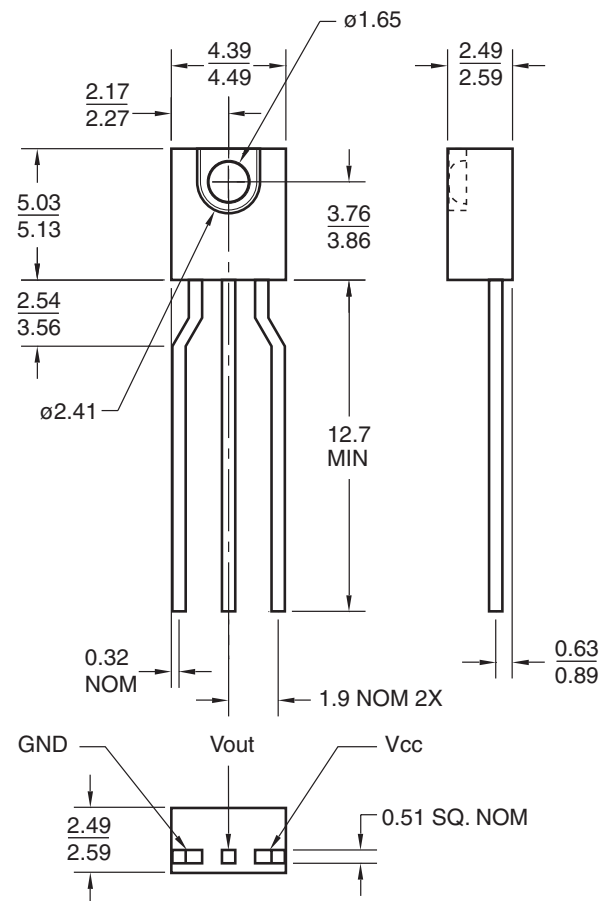
## Features

- Bipolar silicon IC
- Package type: Sidelooker
- Medium wide reception angle, 50°
- Package material and color: black epoxy
- Also available in clear package: "C" suffix
- Matched emitter: QEE113/QEE123
- Daylight filter
- High sensitivity
- Direct TTL/LSTTL interface

## Description

The QSE15X family are OPTOLOGIC® ICs which feature a Schmitt trigger at output which provides hysteresis for noise immunity and pulse shaping. The basic building block of this IC consists of a photodiode, a linear amplifier, voltage regulator, Schmitt trigger and four output options. The TTL/LSTTL compatible output can drive up to ten TTL loads over supply currents from 4.5 to 16.0 Volts. The devices are marked with a color stripe for easy identification.

## Package Dimensions



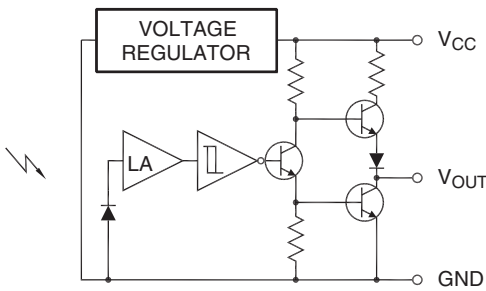
Part Number Definitions		Color Code
QSE156/C	Totem-Pole, buffer output	Red
QSE157/C	Totem-Pole, inverter output	Yellow
QSE158/C	Open-collector, buffer output	Green
QSE159/C	Open-collector, inverter output	Blue

Input/Output Table		
Part Number	Light	Output
QSE156/C	On	HIGH
	Off	LOW
QSE157/C	On	LOW
	Off	HIGH
QSE158/C	On	HIGH
	Off	LOW
QSE159/C	On	LOW
	Off	HIGH

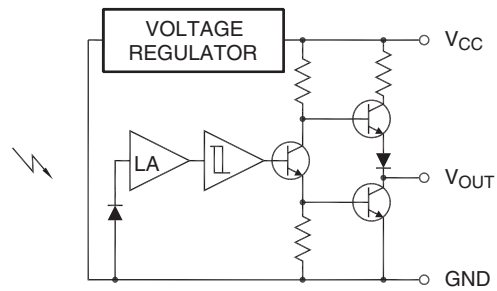
**Note:**

1. Dimensions for all drawings are in millimeters.

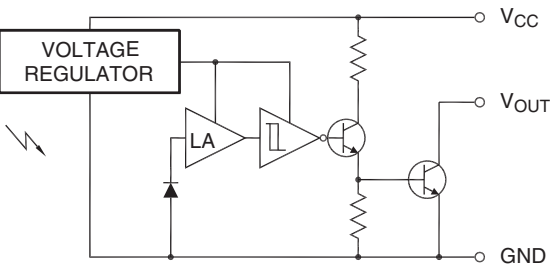
## Block Diagrams



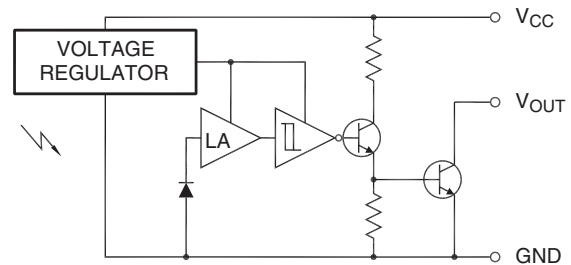
**QSE156**  
Totem-Pole Output Buffer



**QSE157**  
Totem-Pole Output Inverter



**QSE158**  
Open-Collector Output Buffer



**QSE159**  
Open-Collector Output Inverter

## Absolute Maximum Ratings ( $T_A = 25^\circ\text{C}$ unless otherwise specified)

Stresses exceeding the absolute maximum ratings may damage the device. The device may not function or be operable above the recommended operating conditions and stressing the parts to these levels is not recommended. In addition, extended exposure to stresses above the recommended operating conditions may affect device reliability. The absolute maximum ratings are stress ratings only.

Symbol	Parameter	Rating	Unit
$T_{OPR}$	Operating Temperature	-40 to +85	$^\circ\text{C}$
$T_{STG}$	Storage Temperature	-40 to +100	$^\circ\text{C}$
$T_{SOL-I}$	Soldering Temperature (Iron) <sup>(2,3,4)</sup>	240 for 5 sec	$^\circ\text{C}$
$T_{SOL-F}$	Soldering Temperature (Flow) <sup>(2,3)</sup>	260 for 10 sec	$^\circ\text{C}$
$I_O$	Output Current	50	mA
$V_{CC}$	Supply Voltage	4.0 to 16	V
$V_O$	Output Voltage	35	V
$P_D$	Power Dissipation <sup>(1)</sup>	100	mW

### Notes:

1. Derate power dissipation linearly 2.50mW/ $^\circ\text{C}$  above 25 $^\circ\text{C}$ .
2. RMA flux is recommended.
3. Methanol or isopropyl alcohols are recommended as cleaning agents.
4. Soldering iron tip 1/16" (1.6mm) minimum from housing.

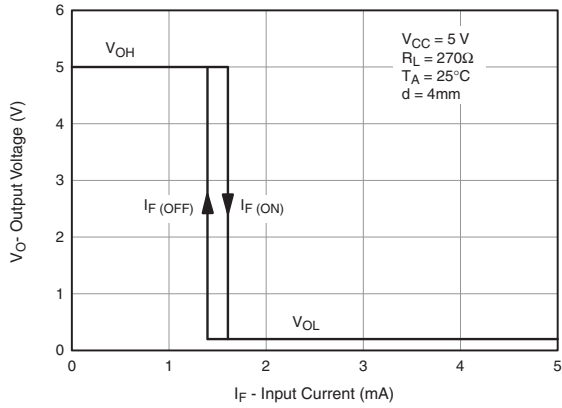
**Electrical Characteristics** ( $T_A = -40^\circ\text{C}$  to  $+85^\circ\text{C}$ ,  $V_{CC} = 4.5\text{V}$  to  $16\text{V}$ )

Symbol	Parameter	Test Conditions	Min.	Typ.	Max.	Units
$E_e(+)$	Positive Going Threshold Irradiance <sup>(5)</sup>	$T_A = 25^\circ\text{C}$	0.025		0.250	$\text{mW}/\text{cm}^2$
$E_e(+)/E_e(-)$	Hysteresis Ratio		1.10		2.00	
$I_{CC}$	Supply Current <sup>(5)</sup>	$E_e = 0$ or $0.3\text{mW}/\text{cm}^2$			5.0	mA
	Peak to Peak Ripple which will Cause False Triggering	$f = \text{DC to } 50\text{MHz}$			2.00	V
<b>QSE156/C (Buffer Totem Pole)</b>						
$V_{OH}$	High Level Output Voltage <sup>(5)</sup>	$E_e = 0.3\text{mW}/\text{cm}^2$ , $I_{OH} = -10\text{mA}$	$V_{CC} - 2.1$			V
$V_{OL}$	Low Level Output Voltage	$E_e = 0$ , $I_{OL} = 16\text{mA}$			0.40	V
<b>QSE157/C (Inverter Totem Pole)</b>						
$V_{OH}$	High Level Output Voltage	$E_e = 0$ , $I_{OH} = -10\text{mA}$	$V_{CC} - 2.1$			V
$V_{OL}$	Low Level Output Voltage <sup>(5)</sup>	$E_e = 0.3\text{mW}/\text{cm}^2$ , $I_{OL} = 16\text{mA}$			0.40	V
<b>QSE158/C (Buffer Open Collector)</b>						
$I_{OH}$	High Level Output Current <sup>(5)</sup>	$E_e = 0.3\text{mW}/\text{cm}^2$ , $V_{OH} = 30\text{V}$			100	$\mu\text{A}$
$V_{OL}$	Low Level Output Voltage	$E_e = 0$ , $I_{OL} = 16\text{mA}$			0.40	V
<b>QSE159/C (Inverter Open Collector)</b>						
$I_{OH}$	High Level Output Current	$E_e = 0$ , $V_{OH} = 30\text{V}$			100	$\mu\text{A}$
$V_{OL}$	Low Level Output Voltage <sup>(5)</sup>	$E_e = 0.3\text{mW}/\text{cm}^2$ , $I_{OL} = 16\text{mA}$			0.40	V
<b>QSE156/C, QSE157/C</b>						
$t_R$ , $t_F$	Output Rise, Fall Times	$E_e = 0$ or $0.3\text{mW}/\text{cm}^2$ , $f = 10\text{kHz}$ , $\text{DC} = 50\%$ , $R_L = 360\Omega$ <sup>(5)</sup>			70	nS
$t_{PHL}$ , $t_{PLH}$	Propagation Delay			6.0		$\mu\text{S}$
<b>QSE158/C, QSE159/C</b>						
$t_R$ , $t_F$	Output Rise, Fall Times	$E_e = 0$ or $0.3\text{mW}/\text{cm}^2$ , $f = 10\text{kHz}$ , $\text{DC} = 50\%$ , $R_L = 360\Omega$ <sup>(5)</sup>			100	nS
$t_{PHL}$ , $t_{PLH}$	Propagation Delay			6.0		$\mu\text{S}$

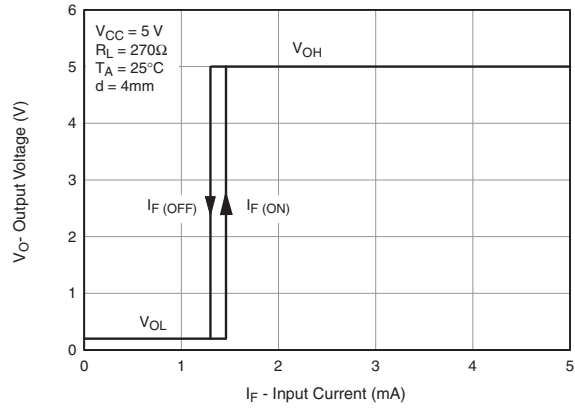
**Note:**5.  $\lambda = 880\text{nm}$  (AlGaAs).

**Typical Performance Curves** (Sensor Coupled to QEE113 Emitter)

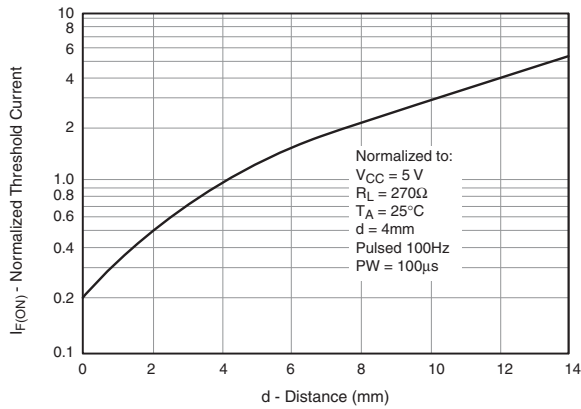
**Fig. 1 Output Voltage vs. Input Current (Inverters)**



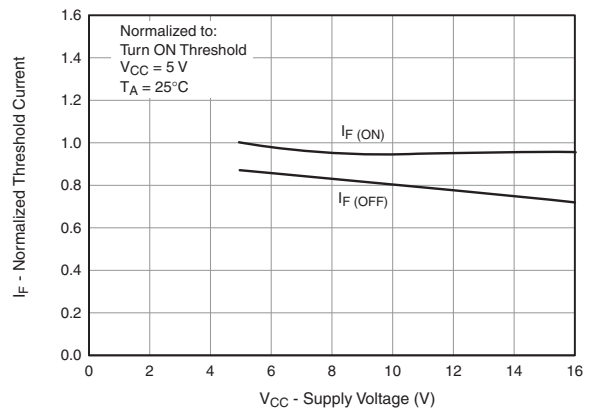
**Fig. 2 Output Voltage vs. Input Current (Buffers)**



**Fig. 3 Threshold Current vs. Distance**

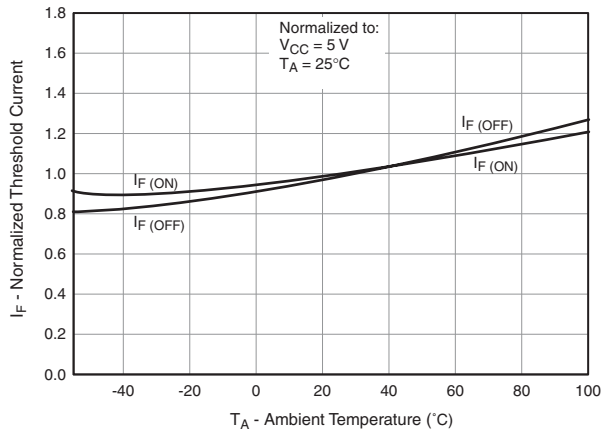


**Fig. 4 Normalized Threshold Current vs. Supply Voltage**

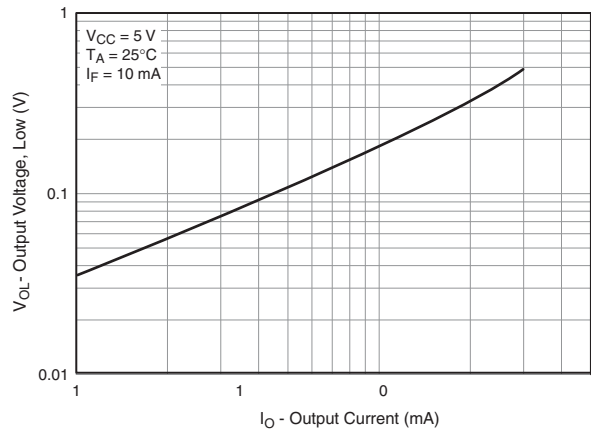


**Typical Performance Curves** (Sensor Coupled to QEE113 Emitter) (Continued)

**Fig. 5 Normalized Threshold Current vs. Ambient Temperature**



**Fig. 6 Low Output Voltage vs. Output Current**



**Fig. 7 Response Time vs. Forward Current**

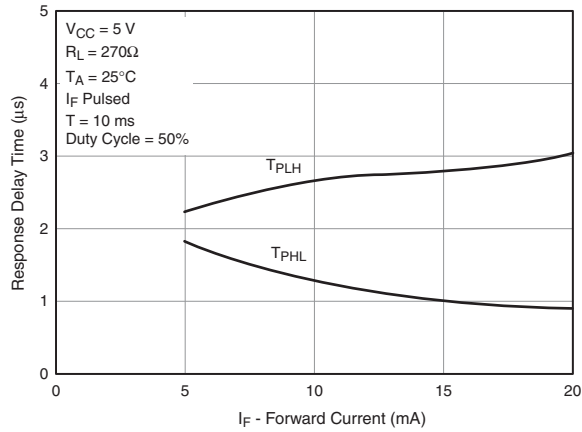


Fig. 8 Switching Speed Test Circuit

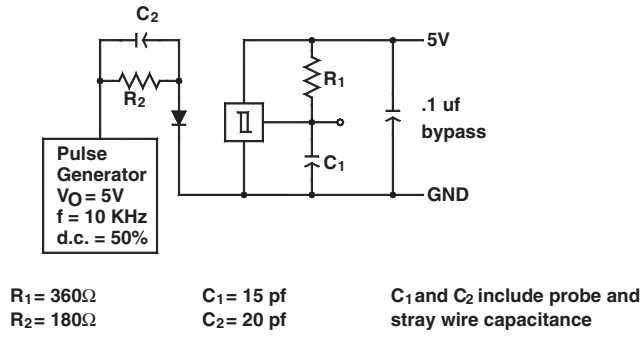


Fig. 9 Switching Times Definition for Buffers

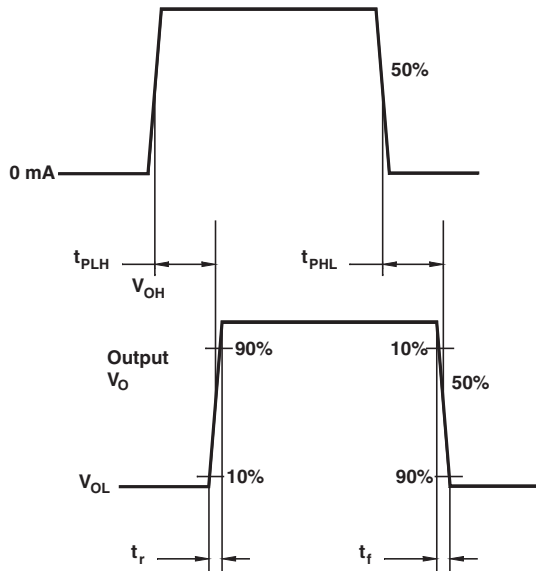
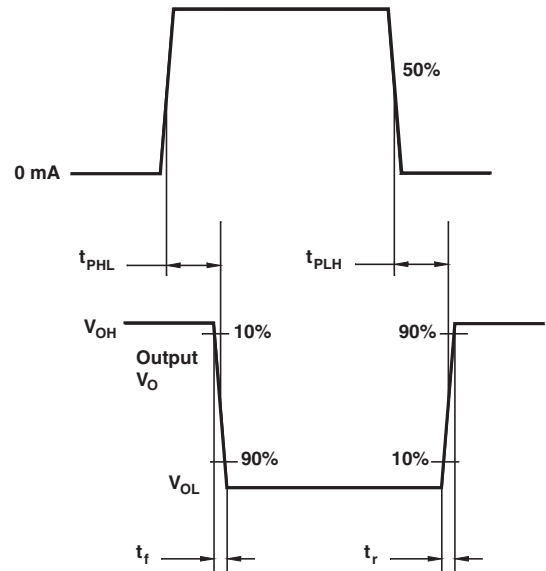







Fig. 10 Switching Times Definition for Inverters





**TRADEMARKS**

The following includes registered and unregistered trademarks and service marks, owned by Fairchild Semiconductor and/or its global subsidiaries, and is not intended to be an exhaustive list of all such trademarks.

- |   |   |   |   |
|---|---|---|---|
| AccuPower™  | F-PFS™  | PowerTrench®  | The Power Franchise®  |
| Auto-SPM™   | FRFET®  | PowerXS™  | The Right Technology for Your Success™  |
| Build it Now™   | Global Power Resource™  | Programmable Active Droop™  | the   |
| CorePLUS™   | Green FPS™  | QFET®   | <b>power</b>  |
| CorePOWER™  | Green FPS™ e-Series™  | QS™   | franchise   |
| CROSSVOLT™  | Gmax™   | Quiet Series™   | TinyBoost™  |
| CTL™  | GTO™  | RapidConfigure™   | TinyBuck™   |
| Current Transfer Logic™   | IntelliMAX™   |  ™ | TinyCalc™   |
| DEUXPEED®   | ISOPLANAR™  | Saving our world, 1mW/W/kW at a time™   | TinyLogic®  |
| Dual Cool™  | MegaBuck™   | SignalWise™   | TINYOPTO™   |
| EcoSPARK®   | MICROCOUPLER™   | SmartMax™   | TinyPower™  |
| EfficientMax™   | MicroFET™   | SMART START™  | TinyPWM™  |
| ESBC™   | MicroPak™   | SPM®  | TinyWire™   |
|  ™ | MicroPak2™  | STEALTH™  | TriFault Detect™  |
| Fairchild®  | MillerDrive™  | SuperFET®   | TRUECURRENT™*   |
| Fairchild Semiconductor®  | MotionMax™  | SuperSOT™-3   | µSerDes™  |
| FACT Quiet Series™  | Motion-SPM™   | SuperSOT™-6   |  ™ |
| FACT®   | OptoHiT™  | SuperSOT™-8   | UHC®  |
| FAST®   | OPTOLOGIC®  | SupreMOS®   | Ultra FRFET™  |
| FastvCore™  | OPTOPLANAR®   | SyncFET™  | UniFET™   |
| FETBench™   |  ™ | Sync-Lock™  | VCX™  |
| FlashWriter®*   | PDP SPM™  |  ™ | VisualMax™  |
| FPS™  | Power-SPM™  |   | XS™   |

\* Trademarks of System General Corporation, used under license by Fairchild Semiconductor.

**DISCLAIMER**

FAIRCHILD SEMICONDUCTOR RESERVES THE RIGHT TO MAKE CHANGES WITHOUT FURTHER NOTICE TO ANY PRODUCTS HEREIN TO IMPROVE RELIABILITY, FUNCTION, OR DESIGN. FAIRCHILD DOES NOT ASSUME ANY LIABILITY ARISING OUT OF THE APPLICATION OR USE OF ANY PRODUCT OR CIRCUIT DESCRIBED HEREIN; NEITHER DOES IT CONVEY ANY LICENSE UNDER ITS PATENT RIGHTS, NOR THE RIGHTS OF OTHERS. THESE SPECIFICATIONS DO NOT EXPAND THE TERMS OF FAIRCHILD'S WORLDWIDE TERMS AND CONDITIONS, SPECIFICALLY THE WARRANTY THEREIN, WHICH COVERS THESE PRODUCTS.

**LIFE SUPPORT POLICY**

FAIRCHILD'S PRODUCTS ARE NOT AUTHORIZED FOR USE AS CRITICAL COMPONENTS IN LIFE SUPPORT DEVICES OR SYSTEMS WITHOUT THE EXPRESS WRITTEN APPROVAL OF FAIRCHILD SEMICONDUCTOR CORPORATION.

As used herein:

- Life support devices or systems are devices or systems which, (a) are intended for surgical implant into the body or (b) support or sustain life, and (c) whose failure to perform when properly used in accordance with instructions for use provided in the labeling, can be reasonably expected to result in a significant injury of the user.
- A critical component in any component of a life support, device, or system whose failure to perform can be reasonably expected to cause the failure of the life support device or system, or to affect its safety or effectiveness.

**ANTI-COUNTERFEITING POLICY**

Fairchild Semiconductor Corporation's Anti-Counterfeiting Policy. Fairchild's Anti-Counterfeiting Policy is also stated on our external website, [www.fairchildsemi.com](http://www.fairchildsemi.com), under Sales Support.

Counterfeiting of semiconductor parts is a growing problem in the industry. All manufacturers of semiconductor products are experiencing counterfeiting of their parts. Customers who inadvertently purchase counterfeit parts experience many problems such as loss of brand reputation, substandard performance, failed applications, and increased cost of production and manufacturing delays. Fairchild is taking strong measures to protect ourselves and our customers from the proliferation of counterfeit parts. Fairchild strongly encourages customers to purchase Fairchild parts either directly from Fairchild or from Authorized Fairchild Distributors who are listed by country on our web page cited above. Products customers buy either from Fairchild directly or from Authorized Fairchild Distributors are genuine parts, have full traceability, meet Fairchild's quality standards for handling and storage and provide access to Fairchild's full range of up-to-date technical and product information. Fairchild and our Authorized Distributors will stand behind all warranties and will appropriately address any warranty issues that may arise. Fairchild will not provide any warranty coverage or other assistance for parts bought from Unauthorized Sources. Fairchild is committed to combat this global problem and encourage our customers to do their part in stopping this practice by buying direct or from authorized distributors.

**PRODUCT STATUS DEFINITIONS**

**Definition of Terms**

Datasheet Identification	Product Status	Definition
Advance Information	Formative / In Design	Datasheet contains the design specifications for product development. Specifications may change in any manner without notice.
Preliminary	First Production	Datasheet contains preliminary data; supplementary data will be published at a later date. Fairchild Semiconductor reserves the right to make changes at any time without notice to improve design.
No Identification Needed	Full Production	Datasheet contains final specifications. Fairchild Semiconductor reserves the right to make changes at any time without notice to improve the design.
Obsolete	Not In Production	Datasheet contains specifications on a product that is discontinued by Fairchild Semiconductor. The datasheet is for reference information only.

Rev. I51