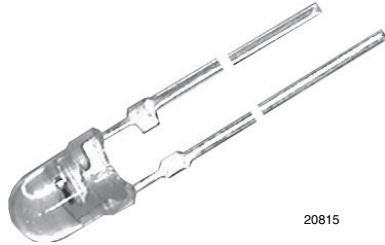


Ambient Light Sensor, RoHS Compliant



FEATURES

- Package type: leaded
- Package form: T-1
- Dimensions (in mm): \varnothing 3
- High photo sensitivity
- Adapted to human eye responsivity
- Angle of half sensitivity: $\varphi = \pm 30^\circ$
- Compliant to RoHS directive 2002/95/EC and in accordance to WEEE 2002/96/EC


RoHS
COMPLIANT

DESCRIPTION

TEPT4400 ambient light sensor is a silicon NPN epitaxial planar phototransistor in a T-1 package. It is sensitive to visible light much like the human eye and has peak sensitivity at 570 nm.

APPLICATIONS

- Ambient light sensor for control of display backlight dimming in LCD displays and keypad backlighting of mobile devices and in industrial on/off-lighting operation
- Replacement of CdS photoresistors

PRODUCT SUMMARY

| COMPONENT | I_{PCE} (A) | φ (deg) | $\lambda_{0.5}$ (nm) |
|-----------|-----------------|-----------------|----------------------|
| TEPT4400 | 200 | ± 30 | 440 to 800 |

Note

Test condition see table "Basic Characteristics"

ORDERING INFORMATION

| ORDERING CODE | PACKAGING | REMARKS | PACKAGE FORM |
|---------------|-----------|---|--------------|
| TEPT4400 | Bulk | MOQ: 5000 pcs, 5000 pcs/bulk. Label with I_{PCE} group on each bulk. Specifications of group A/B/C see table "Type Dedicated Characteristics" on page 2 | T-1 |

Note

MOQ: minimum order quantity

ABSOLUTE MAXIMUM RATINGS

| PARAMETER | TEST CONDITION | SYMBOL | VALUE | UNIT |
|-------------------------------------|---------------------------------|------------|---------------|------------------|
| Collector emitter voltage | | V_{CEO} | 6 | V |
| Emitter collector voltage | | V_{ECO} | 1.5 | V |
| Collector current | | I_C | 20 | mA |
| Power dissipation | $T_{amb} \leq 55^\circ\text{C}$ | P_V | 100 | mW |
| Junction temperature | | T_j | 100 | $^\circ\text{C}$ |
| Operating temperature range | | T_{amb} | - 40 to + 85 | $^\circ\text{C}$ |
| Storage temperature range | | T_{stg} | - 40 to + 100 | $^\circ\text{C}$ |
| Soldering temperature | $t \leq 3$ s | T_{sd} | 260 | $^\circ\text{C}$ |
| Thermal resistance junction/ambient | J-STD-051, soldered on PCB | R_{thJA} | 300 | K/W |

Note

$T_{amb} = 25^\circ\text{C}$, unless otherwise specified

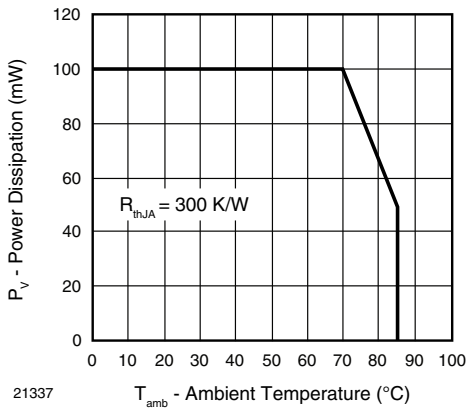


Fig. 1 - Power Dissipation Limit vs. Ambient Temperature

| BASIC CHARACTERISTICS | | | | | | |
|--------------------------------------|--|-----------------|------|------------|------|---------------|
| PARAMETER | TEST CONDITION | SYMBOL | MIN. | TYP. | MAX. | UNIT |
| Collector emitter breakdown voltage | $I_C = 0.1 \text{ mA}$ | V_{CE0} | 6 | | | V |
| Collector dark current | $V_{CE} = 5 \text{ V}, E = 0$ | I_{CEO} | | 3 | 50 | nA |
| Collector emitter capacitance | $V_{CE} = 0 \text{ V}, f = 1 \text{ MHz}, E = 0$ | C_{CEO} | | 16 | | pF |
| Collector light current | $E_V = 20 \text{ lx}, \text{ CIE illuminant A}, V_{CE} = 5 \text{ V}$ | I_{PCE} | 15 | | 70 | μA |
| | $E_V = 100 \text{ lx}, \text{ CIE illuminant A}, V_{CE} = 5 \text{ V}$ | I_{PCE} | | 200 | | μA |
| Angle of half sensitivity | | ϕ | | ± 30 | | deg |
| Wavelength of peak sensitivity | | λ_p | | 570 | | nm |
| Range of spectral bandwidth | | $\lambda_{0.5}$ | | 440 to 800 | | nm |
| Collector emitter saturation voltage | $E_V = 20 \text{ lx}, \text{ CIE illuminant A}, I_{PCE} = 1.2 \mu\text{A}$ | V_{CEsat} | | 0.1 | | V |

Note

$T_{amb} = 25 \text{ }^\circ\text{C}$, unless otherwise specified

| TYPE DEDICATED CHARACTERISTICS | | | | | | |
|--------------------------------|--|--------------|-----------|------|------|---------------|
| PARAMETER | TEST CONDITION | BINNED GROUP | SYMBOL | MIN. | MAX. | UNIT |
| Photo current | $E_V = 20 \text{ lx}, \text{ CIE illuminant A}, V_{CE} = 5 \text{ V}, T_{amb} = 25 \text{ }^\circ\text{C}$ | A | I_{PCE} | 15 | 28.4 | μA |
| | | B | I_{PCE} | 23.5 | 44.6 | μA |
| | | C | I_{PCE} | 36.9 | 70 | μA |

Note

Each 5000 piece bag will contain a single group. The label on the bag will indicate which binned group is in the bag. A specific group cannot be ordered. Production shipments containing multiple bags will likely include multiple groups. Please design accordingly.

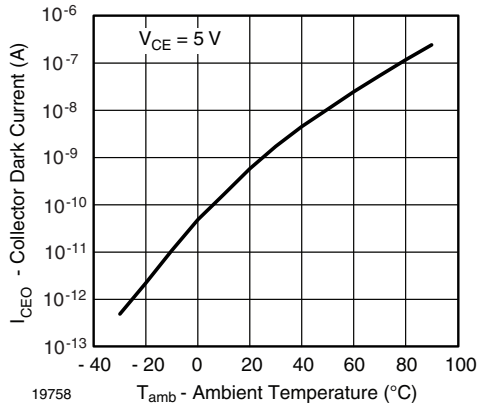
BASIC CHARACTERISTICS
 $T_{amb} = 25\text{ }^{\circ}\text{C}$, unless otherwise specified


Fig. 1 - Collector Dark Current vs. Ambient Temperature

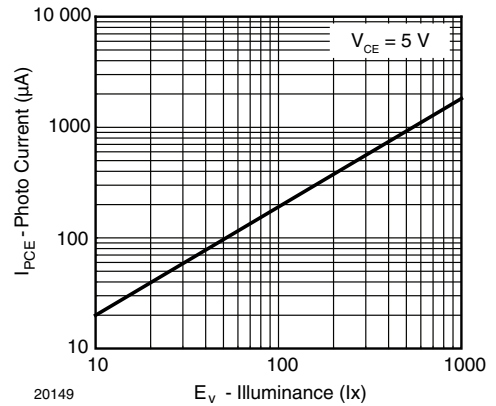


Fig. 4 - Photo Current vs. Illuminance

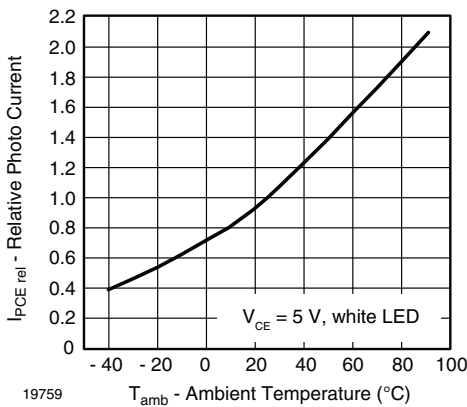


Fig. 2 - Relative Photo Current vs. Ambient Temperature

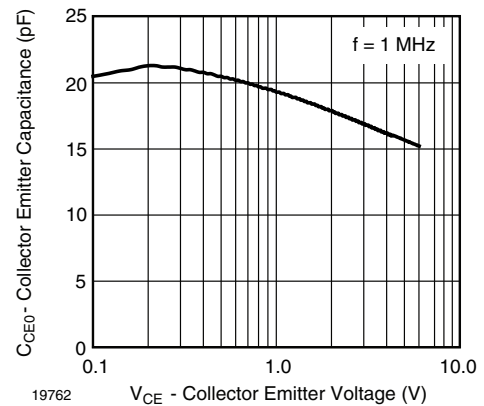


Fig. 5 - Collector Emitter Capacitance vs. Collector Emitter Voltage

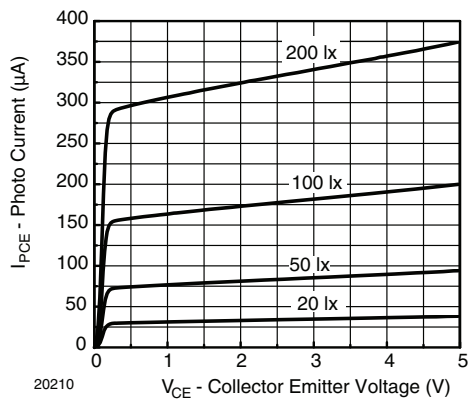


Fig. 3 - Photo Current vs. Collector Emitter Voltage

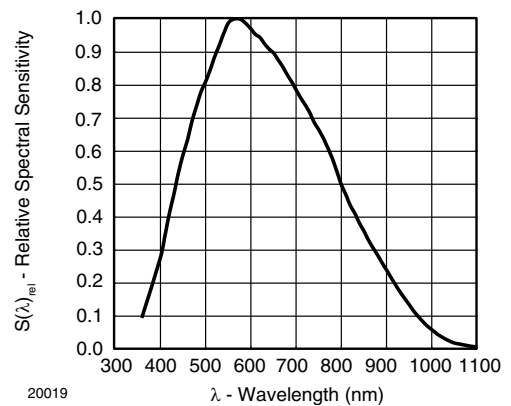


Fig. 6 - Relative Spectral Sensitivity vs. Wavelength

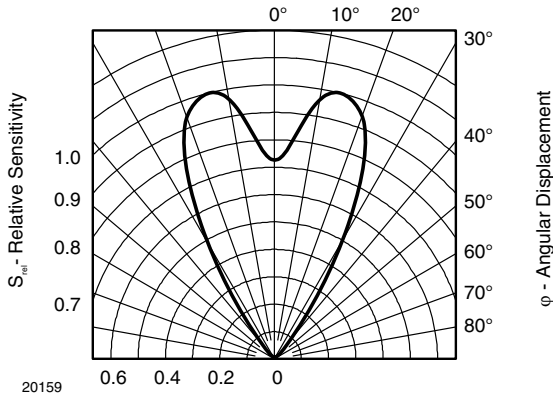
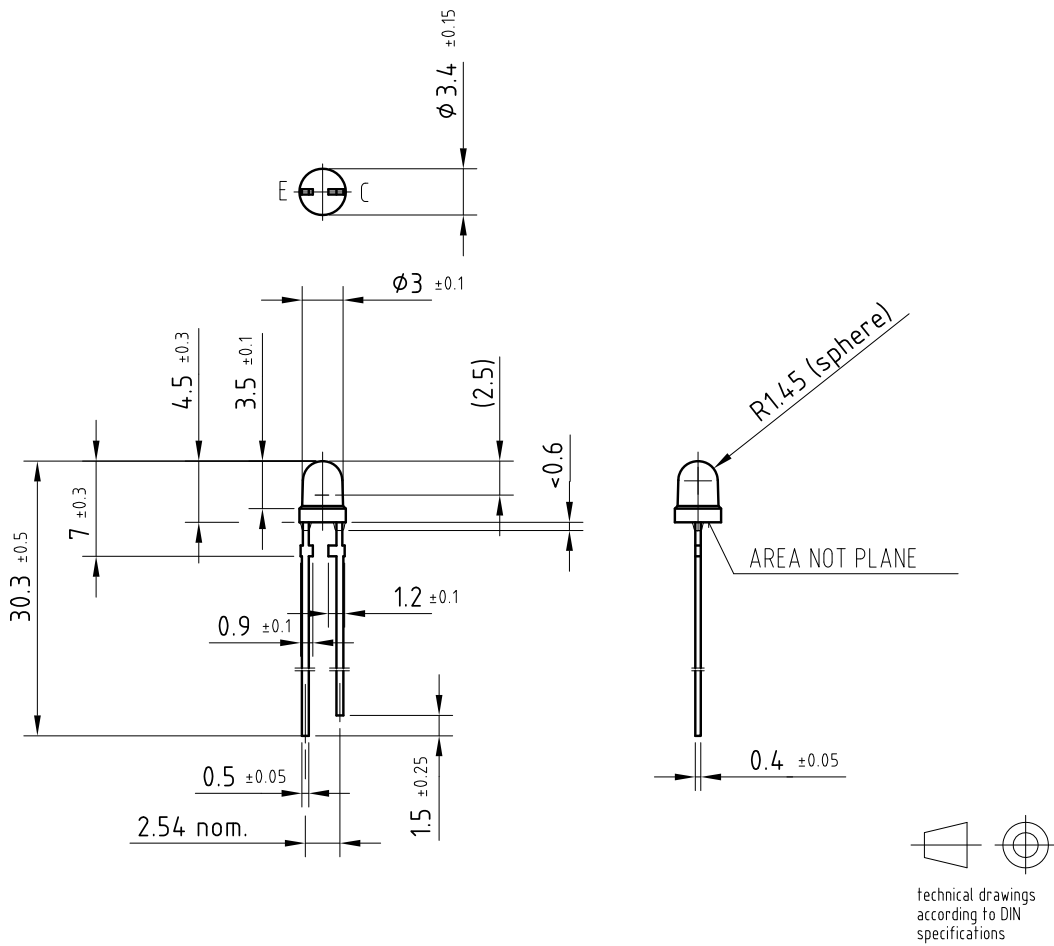


Fig. 7 - Relative Radiant Sensitivity vs. Angular Displacement

PACKAGE DIMENSIONS in millimeters



Drawing-No.: 6.544-5054.01-4

Issue: 2; 12.11.96

96 12190



Disclaimer

ALL PRODUCT, PRODUCT SPECIFICATIONS AND DATA ARE SUBJECT TO CHANGE WITHOUT NOTICE TO IMPROVE RELIABILITY, FUNCTION OR DESIGN OR OTHERWISE.

Vishay Intertechnology, Inc., its affiliates, agents, and employees, and all persons acting on its or their behalf (collectively, "Vishay"), disclaim any and all liability for any errors, inaccuracies or incompleteness contained in any datasheet or in any other disclosure relating to any product.

Vishay makes no warranty, representation or guarantee regarding the suitability of the products for any particular purpose or the continuing production of any product. To the maximum extent permitted by applicable law, Vishay disclaims (i) any and all liability arising out of the application or use of any product, (ii) any and all liability, including without limitation special, consequential or incidental damages, and (iii) any and all implied warranties, including warranties of fitness for particular purpose, non-infringement and merchantability.

Statements regarding the suitability of products for certain types of applications are based on Vishay's knowledge of typical requirements that are often placed on Vishay products in generic applications. Such statements are not binding statements about the suitability of products for a particular application. It is the customer's responsibility to validate that a particular product with the properties described in the product specification is suitable for use in a particular application. Parameters provided in datasheets and/or specifications may vary in different applications and performance may vary over time. All operating parameters, including typical parameters, must be validated for each customer application by the customer's technical experts. Product specifications do not expand or otherwise modify Vishay's terms and conditions of purchase, including but not limited to the warranty expressed therein.

Except as expressly indicated in writing, Vishay products are not designed for use in medical, life-saving, or life-sustaining applications or for any other application in which the failure of the Vishay product could result in personal injury or death. Customers using or selling Vishay products not expressly indicated for use in such applications do so at their own risk and agree to fully indemnify and hold Vishay and its distributors harmless from and against any and all claims, liabilities, expenses and damages arising or resulting in connection with such use or sale, including attorneys fees, even if such claim alleges that Vishay or its distributor was negligent regarding the design or manufacture of the part. Please contact authorized Vishay personnel to obtain written terms and conditions regarding products designed for such applications.

No license, express or implied, by estoppel or otherwise, to any intellectual property rights is granted by this document or by any conduct of Vishay. Product names and markings noted herein may be trademarks of their respective owners.