

ASMT-MxK0

Moonstone™ 1W Power LED Light Source on MCPCB



Data Sheet



Lead (Pb) Free
RoHS 6 fully
compliant

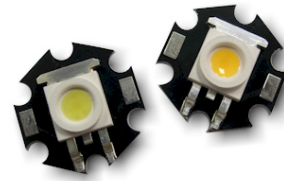

Description

1W Power LED Light Source is a high performance energy efficient device which can handle high thermal and high driving current. The exposed pad design has excellent heat transfer from the package to the motherboard.

The 1W Power LED light source is mounted on to metal core PCB enabling optimum heat dissipation and ease of installation.

The low profile package design is suitable for a wide variety of applications especially where height is a constraint.

Applications

- Portable (flash light, bicycle head light)
- Reading light
- Architectural lighting
- Garden lighting
- Decorative lighting

Features

- Available in Red, Amber, Green, Blue, Cool White and Warm White color.
- Energy efficient
- High current operation.
- Long operation life.
- Wide viewing angle.
- Silicone encapsulation

Specifications

- AllnGaP Technology for Red and Amber
- InGaN Technology for Green, Blue, Cool White and Warm White color
- 2.4V, 350mA (typical) for AllnGaP Technology
- 3.6V, 350 mA (typical) for InGaN Technology
- 110 viewing angle for White Products
- 120 viewing angle for Mono color Products

Package Dimensions

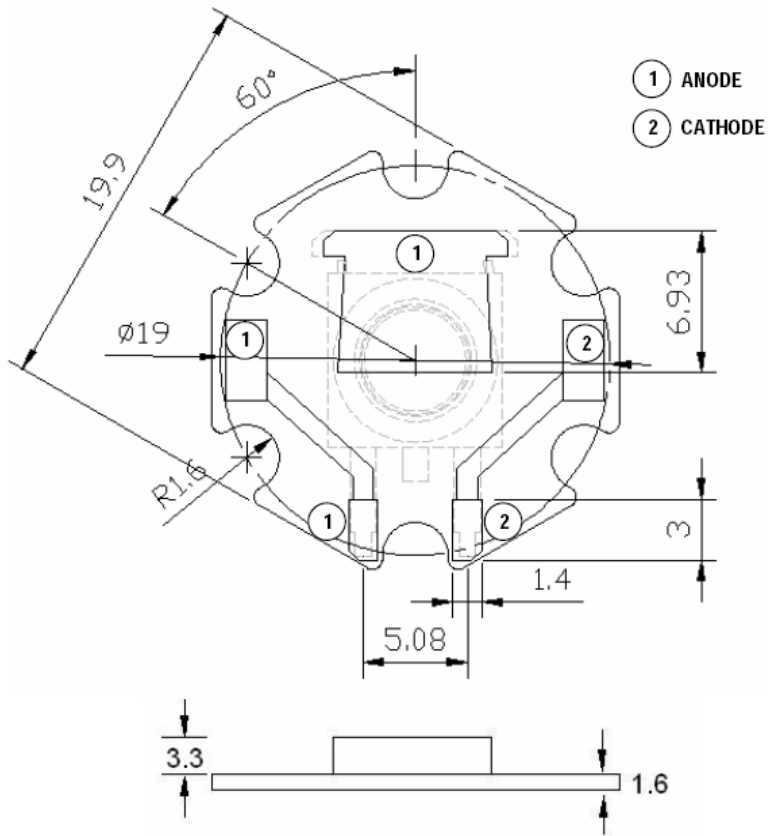

Notes:

1. All dimensions in millimeters
2. Tolerance is ± 0.1 mm unless otherwise specified.

Device Selection Guide at Junction Temperature $T_j = 25^\circ\text{C}$

Color	Part Number	Luminous Flux, $\Phi_v^{[1,2,3]}$ (lm)			Test Current	Dice Technology
		Min	Typ	Max	(mA)	
Red	ASMT-MRK0	25.5	40.0	56.0	350	AllInGaP
Amber	ASMT-MAK0	25.5	35.0	43.0	350	AllInGaP
Green	ASMT-MGK0	43.0	60.0	73.0	350	InGaN
Blue	ASMT-MBK0	11.5	15.0	25.5	350	InGaN
Cool White	ASMT-MWK0	43.0	60.0	73.0	350	InGaN
Warm White	ASMT-MYK0	43.0	50.0	73.0	350	InGaN

Notes:

- Φ_v is the total luminous flux output as measured with an integrating sphere at 25ms mono pulse condition.
- Flux tolerance is $\pm 10\%$
- Φ_v data are only applicable for ASMT-Mx00 component level device only.

Part Numbering System

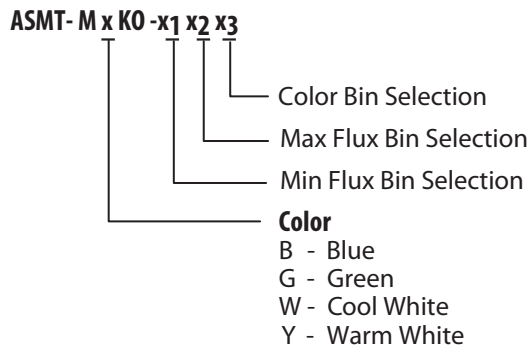

Absolute Maximum Ratings^[4] at $T_A = 25^\circ\text{C}$

Parameters	ASMT - Mx KO	Units
DC Forward Current ^[5]	350	mA
Peak Pulsing Current ^[6]	500	mA
Power Dissipation for AllInGaP	1050	mW
Power Dissipation for InGaN	1400	mW
LED Junction Temperature for AllInGaP	120	$^\circ\text{C}$
LED Junction Temperature for InGaN	110	$^\circ\text{C}$
Operating Ambient Temperature Range	-40 to + 85	$^\circ\text{C}$
Storage Temperature Range	-40 to + 100	$^\circ\text{C}$

Note:

- Absolute Maximum Rating data are only applicable for ASMT-Mx00 component level device only.
- DC forward current – derate linearly based on Figure 5 for AllInGaP & Figure 11 for InGaN.
- Pulse condition duty factor = 10%, Frequency = 1kHz.

Optical Characteristics^[1] (T_A = 25 °C)

Part Number	Color	Peak Wavelength	Dominant Wavelength	Viewing Angle	Luminous Efficiency
		λ_{PEAK} (nm)	λ_D [2] (nm)	$2\theta_{1/2}$ [3] (Degrees)	(lm/W)
		Typ.	Typ.	Typ.	Typ.
ASMT-MRK0	Red	635	625	120	48
ASMT-MAK0	Amber	598	590	120	42
ASMT-MGK0	Green	519	525	120	48
ASMT-MBK0	Blue	460	467	120	12

Part Number	Color	Correlated Color Temperature, CCT (Kelvin)		Viewing Angle	Luminous Efficiency
		Min	Max	$2\theta_{1/2}$ [2] (Degrees)	(lm/W)
				Typ	Typ
ASMT-MWK0	Cool White	4000	10000	110	48
ASMT-MYK0	Warm White	2600	4000	110	40

Notes:

- Optical Characteristics data are only applicable for ASMT-Mx00 component level device only.
- The dominant wavelength, λ_D , is derived from the CIE Chromaticity Diagram and represents the color of the device.
- $\theta_{1/2}$ is the off-axis angle where the luminous intensity is 1/2 the peak intensity.

Electrical Characteristic^[4] (T_A = 25 °C)

Dice Type	Forward Voltage V _F (Volts) @ I _F = 350mA			Reverse Voltage V _R (Volts)	Thermal Resistance R _{θj-b} (°C/W) [5]
	Min	Typ	Max.	Max.	Typ.
AllnGaP	2.0	2.4	3.0	5	12
InGaN	3.2	3.6	4.0	5	18

Note:

- Electrical Characteristic data are only applicable for ASMT-Mx00 component level device only.
- R_{θj-b} is Thermal Resistance from LED junction to MCPCB.

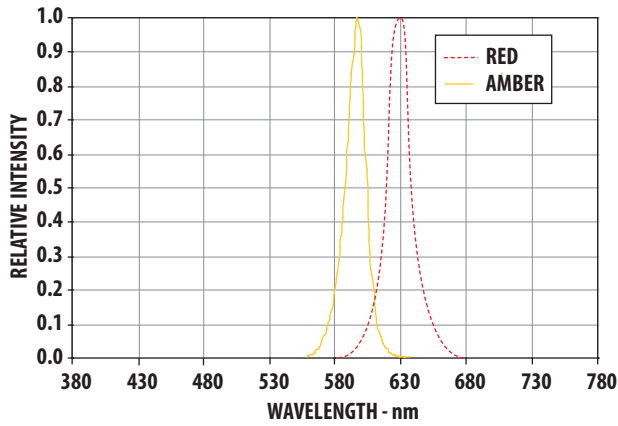

Figure 1. Relative Intensity vs. Wavelength for AlInGaP

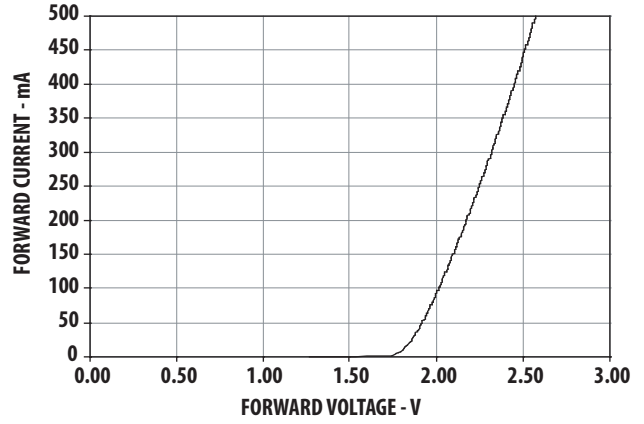

Figure 2. Forward Current vs Forward Voltage for AlInGaP

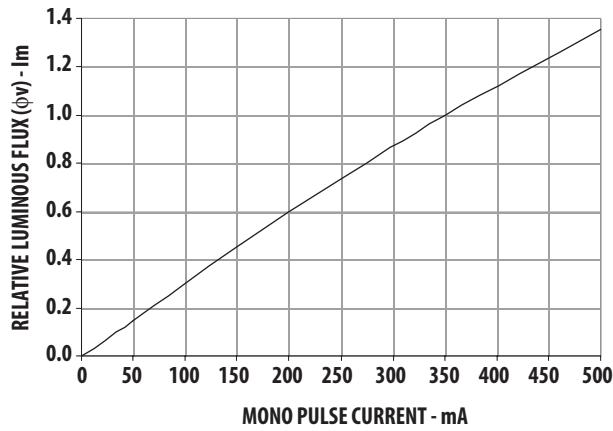

Figure 3. Relative Luminous Flux vs. Mono Pulse Current for AlInGaP

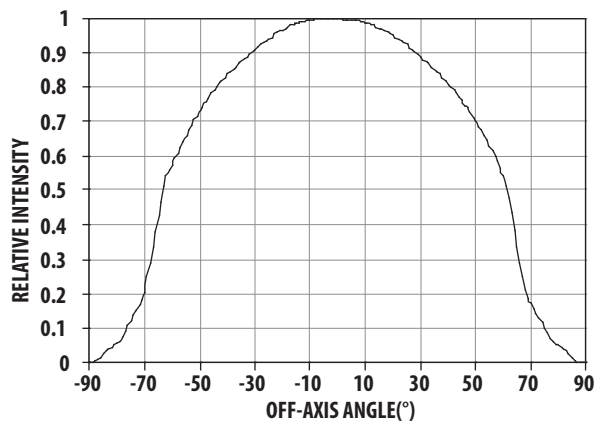

Figure 4. Radiation Pattern for AlInGaP

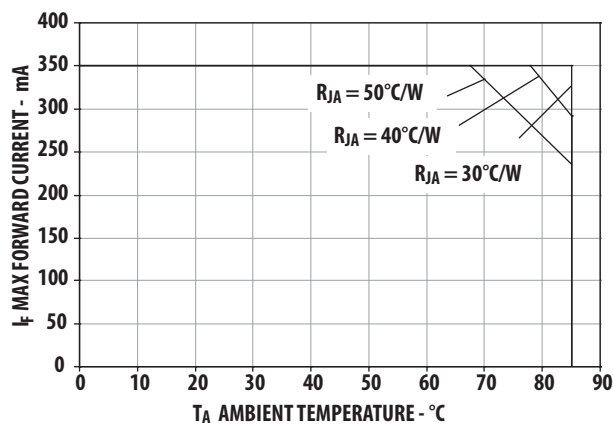

Figure 5. Maximum forward current vs. ambient temperature for AlInGaP Derated based on $T_{jMAX} = 120^{\circ}\text{C}$, $R_{\theta JA} = 30^{\circ}\text{C/W}$ / 40°C/W and 50°C/W

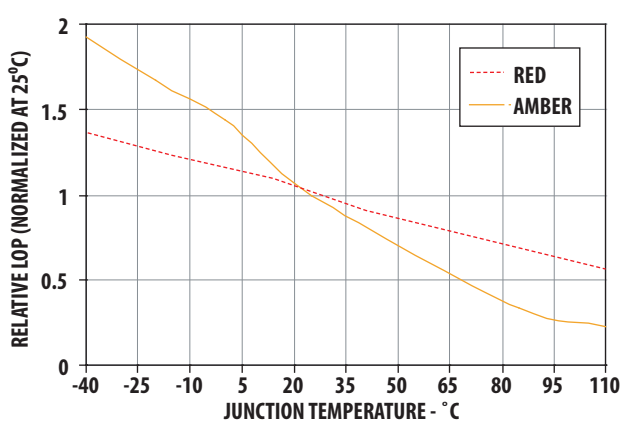

Figure 6. Relative LOP (Normalized at 25°C) vs. junction temperature for AlInGaP

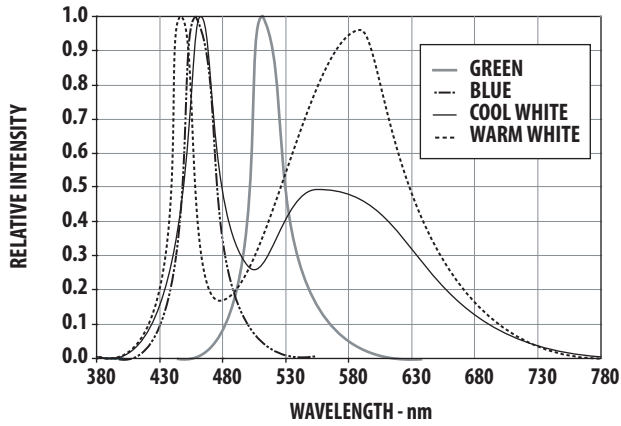

Figure 7. Relative Intensity vs. Wavelength for InGaN

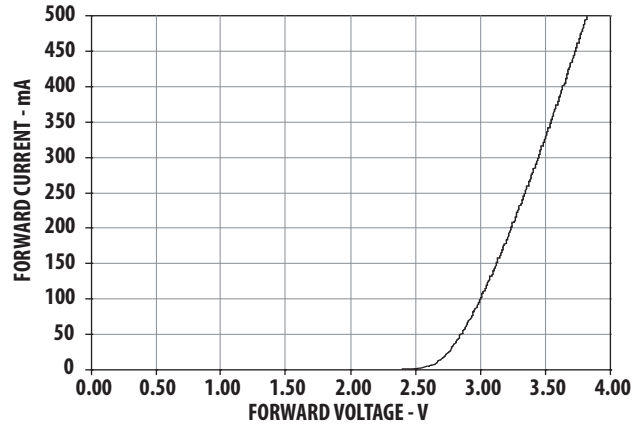

Figure 8. Forward Current vs Forward Voltage for InGaN

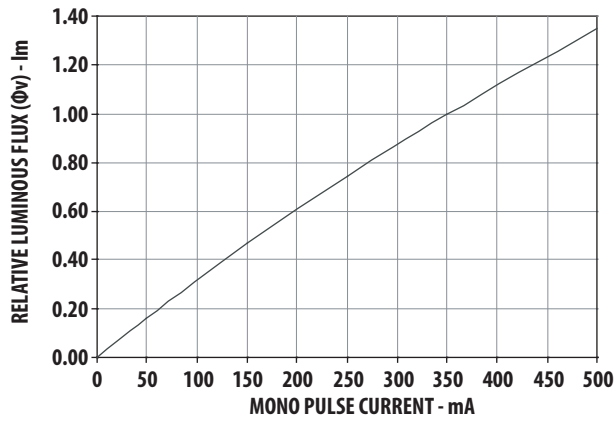

Figure 9. Relative Luminous Flux vs. Mono Pulse Current for InGaN

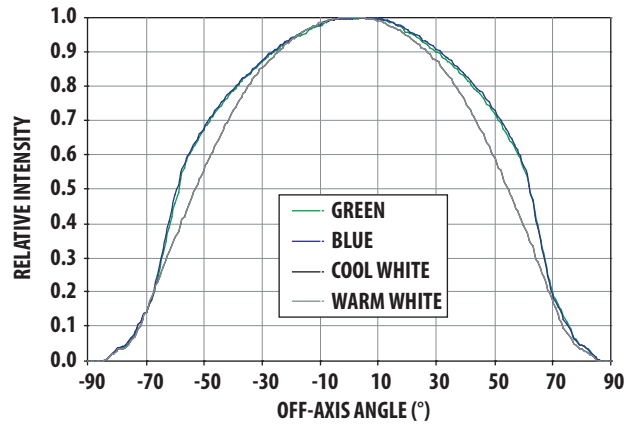

Figure 10. Radiation Pattern for InGaN

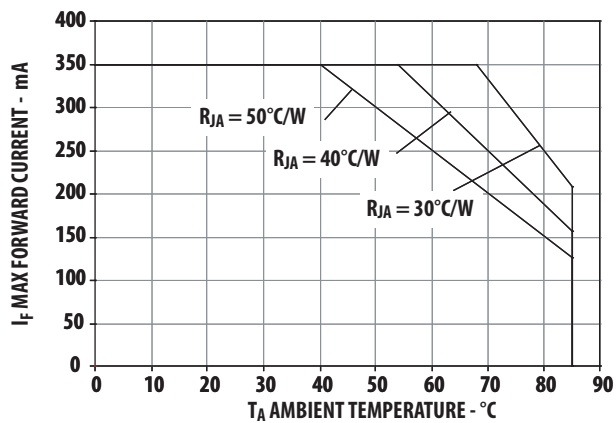

Figure 11. Maximum forward current vs. ambient temperature for InGaN
Derated based on $T_{jMAX} = 110^{\circ}C$, $R_{\theta JA} = 30^{\circ}C/W$ / $40^{\circ}C/W$ and $50^{\circ}C/W$

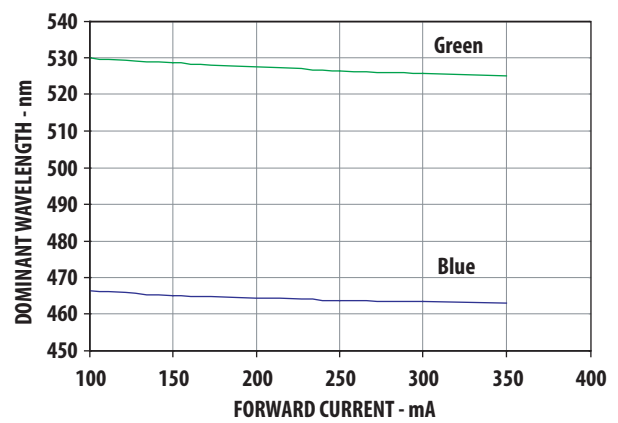

Figure 12. Dominant wavelength vs. forward current – InGaN devices

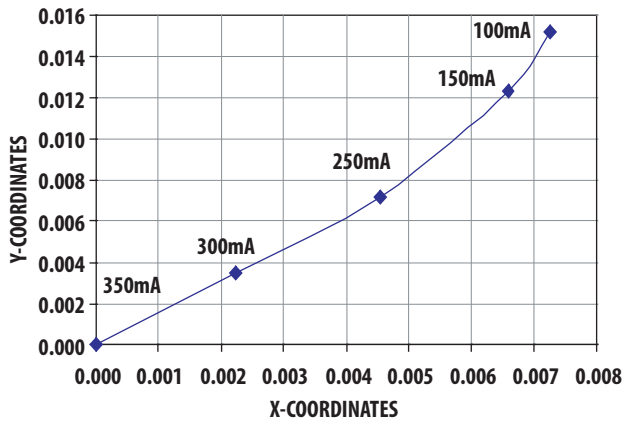

Figure 13. Chromaticity Shift vs. Current

*Note: (x,y) values @ 350mA reference to (0,0)

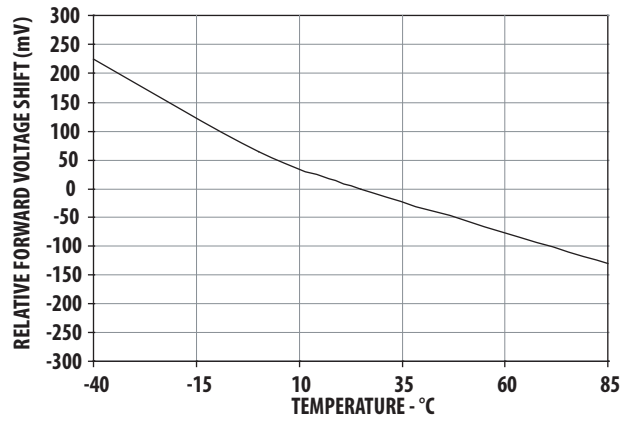

Figure 14. Temperature vs. relative forward voltage shift

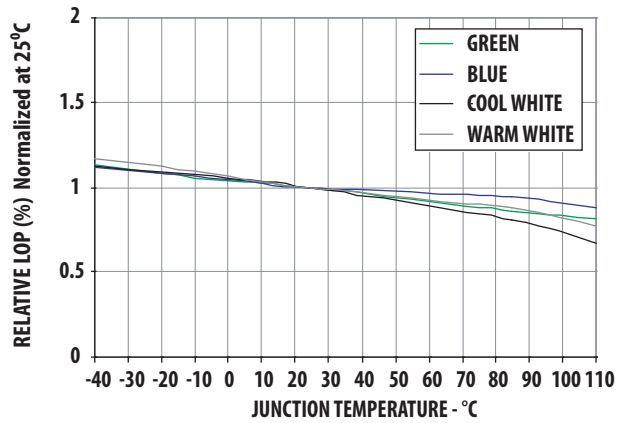

Figure 15. Relative LOP vs. junction temperature for InGaN

Note: All parametric charts are only applicable for ASMT-Mx00 component level device only

Flux Bin Limit^[1] (For reference only) [x₁ x₂]

Bin	Flux (lm) at 350mA	
	Min	Max
A	5.5	7.0
B	7.0	9.0
C	9.0	11.5
D	11.5	15.0
E	15.0	19.5
F	19.5	25.5
G	25.5	33.0
H	33.0	43.0
J	43.0	56.0
K	56.0	73.0

Tolerance for each bin limits is $\pm 10\%$

Note:

1. Flux Bin Limit is only applicable for ASMT-Mx00 component level device only

Color Bin Selections [x₃]

Individual reel will contain parts from one full bin only.

Cool White

0	Full Distribution
A	A only
B	B only
C	C only
D	D only
E	E only
F	F only
G	G only
H	H only
Z	A and B only
Y	B and C only
W	C and D only
V	D and E only
U	E and F only
T	F and G only
S	G and H only
Q	A, B and C only
P	B, C and D only
N	C, D and E only
M	D, E and F only
L	E, F and G only
K	F, G and H only
J	Special Color Bin
1	A, B, C and D only
2	E, F, G and H only
3	B, C, D and E only
4	C, D, E and F only
5	A, B, C, D and E only
6	B, C, D, E, and F only

Color Bin Limits

Amber	Min. (nm)	Max. (nm)
A	582.0	584.5
B	584.5	587.0
C	587.0	589.5
D	589.5	592.0
E	592.0	594.5

Blue	Min. (nm)	Max. (nm)
A	460.0	465.0
B	465.0	470.0
C	470.0	475.0
D	475.0	480.0

Green	Min. (nm)	Max. (nm)
A	515.0	520.0
B	520.0	525.0
C	525.0	530.0
D	530.0	535.0

Warm White

0	Full Distribution
A	A only
B	B only
C	C only
D	D only
E	E only
F	F only
Z	A and B only
Y	B and C only
W	C and D only
V	D and E only
U	E and F only
Q	A, B and C only
P	B, C and D only
N	C, D and E only
M	D, E and F only
J	Special Color Bin
1	A, B, C and D only
2	E, F, G and H only
3	B, C, D and E only
4	C, D, E and F only
5	A, B, C, D and E only
6	B, C, D, E, and F only

Primary Color Binning

Cool White		Color Limits ^[1] (Chromaticity Coordinates)			
		X	Y	X	Y
Bin A	X	0.367	0.362	0.329	0.329
	Y	0.400	0.372	0.345	0.369
Bin B	X	0.362	0.356	0.329	0.329
	Y	0.372	0.330	0.302	0.345
Bin C	X	0.329	0.329	0.305	0.301
	Y	0.369	0.345	0.322	0.342
Bin D	X	0.329	0.329	0.311	0.305
	Y	0.345	0.302	0.285	0.322
Bin E	X	0.303	0.307	0.283	0.274
	Y	0.333	0.311	0.284	0.301
Bin F	X	0.307	0.311	0.290	0.283
	Y	0.311	0.285	0.265	0.284
Bin G	X	0.388	0.379	0.362	0.367
	Y	0.417	0.383	0.372	0.400
Bin H	X	0.379	0.369	0.356	0.362
	Y	0.383	0.343	0.330	0.372

Tolerance ± 0.01

Warm White		Color Limits ^[1] (Chromaticity Coordinates)			
		X	Y	X	Y
Bin A	X	0.452	0.488	0.470	0.438
	Y	0.434	0.447	0.414	0.403
Bin B	X	0.438	0.470	0.452	0.424
	Y	0.403	0.414	0.384	0.376
Bin C	X	0.407	0.418	0.452	0.438
	Y	0.393	0.422	0.434	0.403
Bin D	X	0.395	0.407	0.438	0.424
	Y	0.362	0.393	0.403	0.376
Bin E	X	0.381	0.387	0.418	0.407
	Y	0.377	0.404	0.422	0.393
Bin F	X	0.373	0.381	0.407	0.395
	Y	0.349	0.377	0.393	0.362

Tolerances ± 0.01

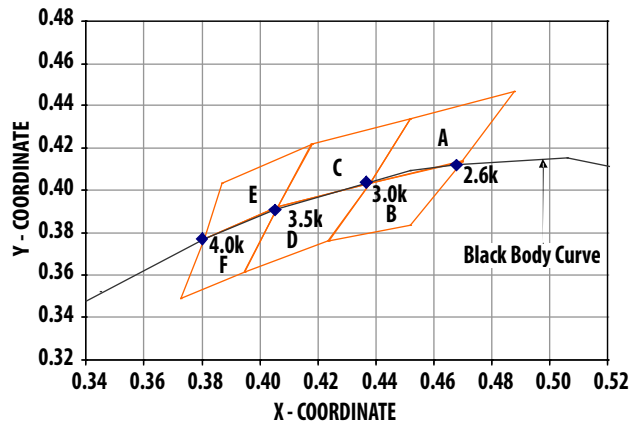
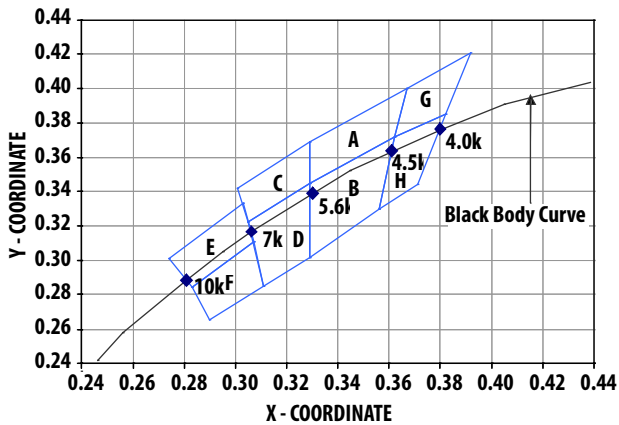

Note:

1. Color Limit and Color binning chart are only applicable for ASMT-Mx00 component level device only

Sub-Color Binning

(Only Applicable for Color Bin A to Bin D and Bin G to Bin H)

Color Limits^[1]

Cool White		(Chromaticity Coordinates)			
Bin A1	X	0.364	0.367	0.348	0.347
	Y	0.383	0.400	0.385	0.372
Bin A2	X	0.364	0.362	0.346	0.347
	Y	0.383	0.372	0.359	0.372
Bin A3	X	0.329	0.329	0.348	0.347
	Y	0.357	0.369	0.385	0.372
Bin A4	X	0.329	0.329	0.347	0.346
	Y	0.345	0.357	0.372	0.359
Bin B1	X	0.362	0.360	0.344	0.346
	Y	0.372	0.357	0.344	0.359
Bin B2	X	0.360	0.358	0.343	0.344
	Y	0.357	0.343	0.331	0.344
Bin B3	X	0.358	0.356	0.341	0.343
	Y	0.343	0.330	0.314	0.331
Bin B4	X	0.329	0.329	0.346	0.344
	Y	0.331	0.345	0.359	0.344
Bin B5	X	0.329	0.344	0.343	0.329
	Y	0.331	0.344	0.331	0.320
Bin B6	X	0.343	0.341	0.329	0.329
	Y	0.331	0.314	0.302	0.320
Bin C1	X	0.329	0.329	0.315	0.314
	Y	0.369	0.357	0.344	0.355
Bin C2	X	0.329	0.329	0.316	0.315
	Y	0.357	0.345	0.333	0.344
Bin C3	X	0.314	0.315	0.303	0.301
	Y	0.355	0.344	0.333	0.342
Bin C4	X	0.315	0.316	0.305	0.303
	Y	0.344	0.333	0.322	0.333

Warm White		(Chromaticity Coordinates)			
Bin D1	X	0.329	0.329	0.317	0.316
	Y	0.345	0.331	0.320	0.33
Bin D2	X	0.329	0.329	0.318	0.317
	Y	0.331	0.320	0.310	0.320
Bin D3	X	0.329	0.329	0.320	0.318
	Y	0.320	0.302	0.293	0.310
Bin D4	X	0.316	0.317	0.307	0.305
	Y	0.333	0.320	0.311	0.322
Bin D5	X	0.317	0.318	0.309	0.307
	Y	0.320	0.310	0.300	0.311
Bin D6	X	0.318	0.320	0.311	0.309
	Y	0.310	0.293	0.285	0.300
Bin G1	X	0.392	0.386	0.364	0.367
	Y	0.421	0.400	0.383	0.400
Bin G2	X	0.386	0.382	0.362	0.364
	Y	0.400	0.385	0.372	0.383
Bin H1	X	0.382	0.378	0.360	0.362
	Y	0.385	0.370	0.357	0.372
Bin H2	X	0.378	0.375	0.358	0.360
	Y	0.370	0.358	0.34	0.357
Bin H3	X	0.375	0.371	0.356	0.358
	Y	0.358	0.344	0.330	0.343

Tolerance ± 0.01

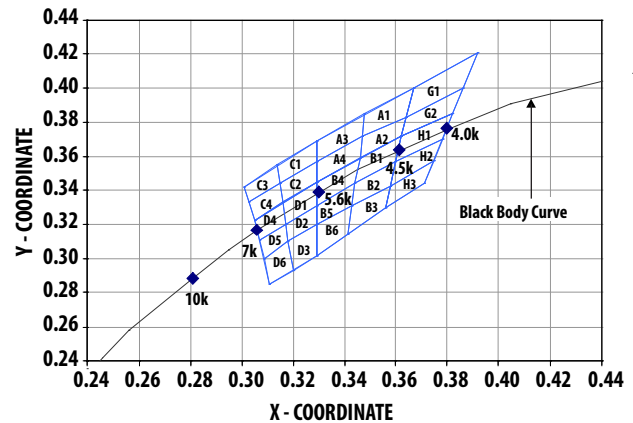

Note:

1. Color Limit and Color binning chart are only applicable for ASMT-Mx00 component level device only

Package Tray Dimensions

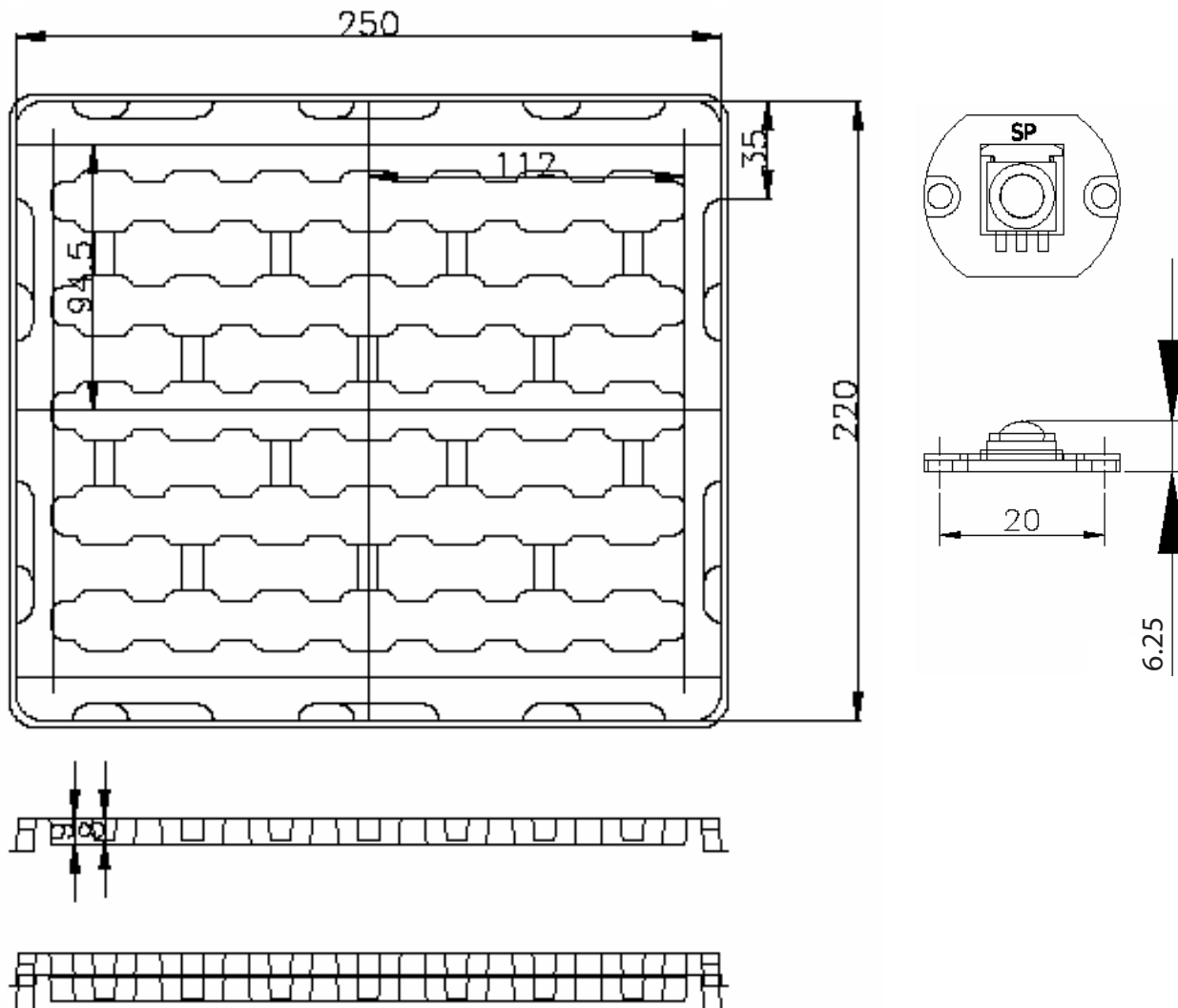

Handling Precaution

The encapsulation material of the product is made of silicone for better reliability of the product. As silicone is a soft material, please do not press on the silicone or poke a sharp object onto the silicone. These might damage the product and cause premature failure. During assembly or handling, the unit should be held on the body (white plastic).

DISCLAIMER: AVAGO'S PRODUCTS AND SOFTWARE ARE NOT SPECIFICALLY DESIGNED, MANUFACTURED OR AUTHORIZED FOR SALE AS PARTS, COMPONENTS OR ASSEMBLIES FOR THE PLANNING, CONSTRUCTION, MAINTENANCE OR DIRECT OPERATION OF A NUCLEAR FACILITY OR FOR USE IN MEDICAL DEVICES OR APPLICATIONS. CUSTOMER IS SOLELY RESPONSIBLE, AND WAIVES ALL RIGHTS TO MAKE CLAIMS AGAINST AVAGO OR ITS SUPPLIERS, FOR ALL LOSS, DAMAGE, EXPENSE OR LIABILITY IN CONNECTION WITH SUCH USE.

For product information and a complete list of distributors, please go to our web site: www.avagotech.com

Avago, Avago Technologies, and the A logo are trademarks of Avago Technologies in the United States and other countries. Data subject to change. Copyright © 2005-2009 Avago Technologies. All rights reserved. AV02-1086EN - April 1, 2009

AVAGO
TECHNOLOGIES