

### PRELIMINARY SPEC

Part Number: AT3535ZG10ZS-RV

Green



**ATTENTION**  
OBSERVE PRECAUTIONS  
FOR HANDLING  
ELECTROSTATIC  
DISCHARGE  
SENSITIVE  
DEVICES



### Features

1. Dimensions : 3.5mm X 3.5mm X 0.8mm.
2. Higher brightness .
3. Small package with high efficiency .
4. Surface mount technology .
5. ESD protection .
6. Moisture sensitivity level : level 2a.
7. Soldering methods: IR reflow soldering.
8. RoHS compliant.

### Material as follows:

Package : Ceramics  
Encapsulating resin : Silicone resin  
Electrodes : Ag plating

### Package Dimensions

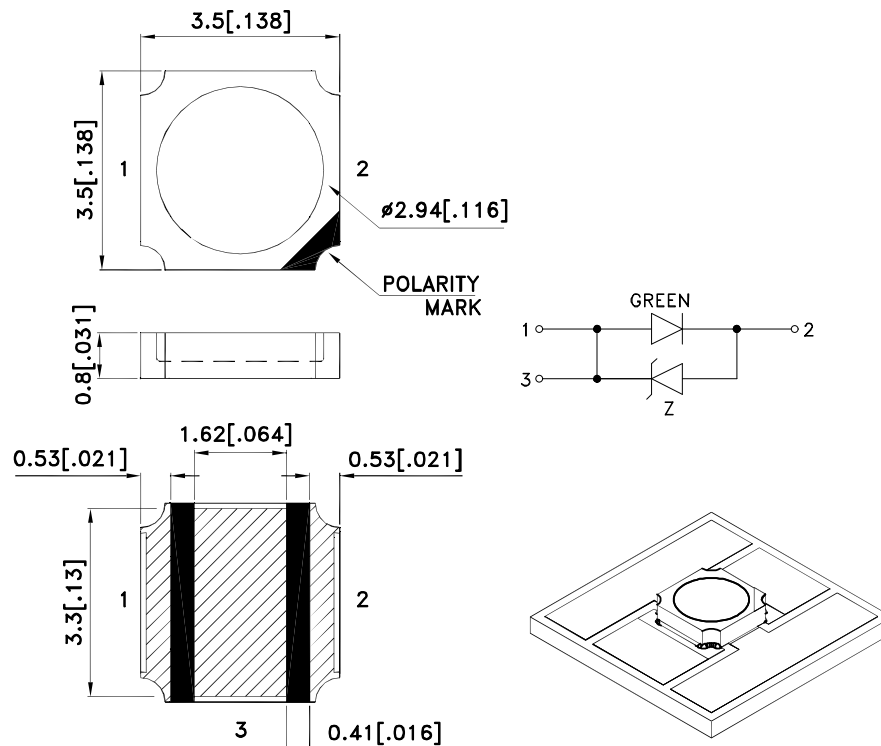

### Notes:

1. All dimensions are in millimeters (inches).
2. Tolerance is  $\pm 0.25$  (0.01") unless otherwise noted.
3. Specifications are subject to change without notice.
4. The device has a single mounting surface. The device must be mounted according to the specifications.



### Selection Guide

Part No.	Dice	$\Phi_v$ (lm) [2] @ 350mA			Viewing Angle [1]
		Code.	Min.	Max.	2 $\theta$ 1/2
AT3535ZG10ZS-RV	Green (AlGaInN)	B9	42	50	120°
		B10	50	60	
		B11	60	70	

Notes:

1.  $\theta$ 1/2 is the angle from optical centerline where the luminous intensity is 1/2 the optical centerline value.
2. Luminous intensity / luminous flux: +/-15%.

### Absolute Maximum Ratings at T<sub>A</sub> = 25°C

Parameter	Symbol	Value	Unit
DC Forward Current [1]	I <sub>F</sub>	350	mA
Peak Forward Current [2]	I <sub>FM</sub>	500	mA
Power dissipation	P <sub>t</sub>	1.3	W
Operating Temperature	T <sub>op</sub>	-40 To +100	°C
Storage Temperature	T <sub>stg</sub>	-40 To +120	°C
Junction temperature[1]	T <sub>J</sub>	120	°C
Thermal resistance [1] (Junction/ambient)	R <sub>th j-a</sub>	75	°C/W
Thermal resistance [1] (Junction/solder point)	R <sub>th j-s</sub>	28	°C/W

Notes:

1. Results from mounting on metal core PCB, mounted on pc board-metal core PCB is recommend for lowest thermal resistance.
2. 1/10 Duty Cycle, 0.1ms Pulse Width.

### Electrical / Optical Characteristics at T<sub>A</sub> = 25°C

Parameter	Symbol	Value	Unit
Forward Voltage I <sub>F</sub> = 350mA [Min.]	V <sub>F</sub> [2]	2.7	V
Forward Voltage I <sub>F</sub> = 350mA [Typ.]		3.3	
Forward Voltage I <sub>F</sub> = 350mA [Max.]		3.8	
Luminous Flux I <sub>F</sub> = 350mA [Typ.]	$\Phi_v$	55	lm
Wavelength at peak emission I <sub>F</sub> = 350mA [Typ.]	$\lambda_{peak}$	520	nm
Dominant Wavelength I <sub>F</sub> = 350mA [Typ.]	$\lambda_{dom}$ [1]	530	nm
Spectral bandwidth at 50% $\Phi_{REL MAX}$ I <sub>F</sub> = 350mA [Typ.]	$\Delta\lambda$	35	nm
Temperature coefficient of $\lambda_{peak}$ I <sub>F</sub> = 350mA, -10°C ≤ T ≤ 100°C [Typ.]	TC <sub><math>\lambda_{peak}</math></sub>	0.16	nm/°C
Temperature coefficient of $\lambda_{dom}$ I <sub>F</sub> = 350mA, -10°C ≤ T ≤ 100°C [Typ.]	TC <sub><math>\lambda_{dom}</math></sub>	0.14	nm/°C
Temperature coefficient of V <sub>F</sub> I <sub>F</sub> = 350mA, -10°C ≤ T ≤ 100°C [Typ.]	TC <sub>V</sub>	-3.1	mV/°C

Notes:

1. Wavelength : + / -1nm.
2. Forward Voltage : + / - 0.1V.

**Green AT3535ZG10ZS-RV**

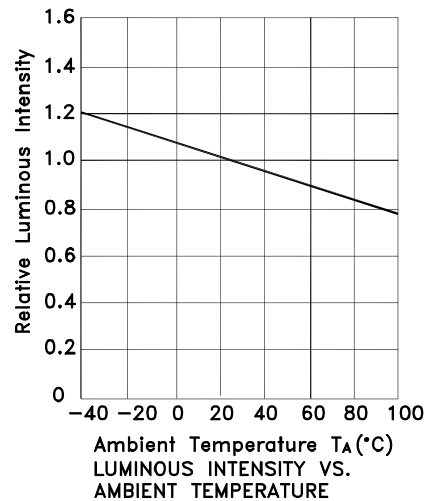
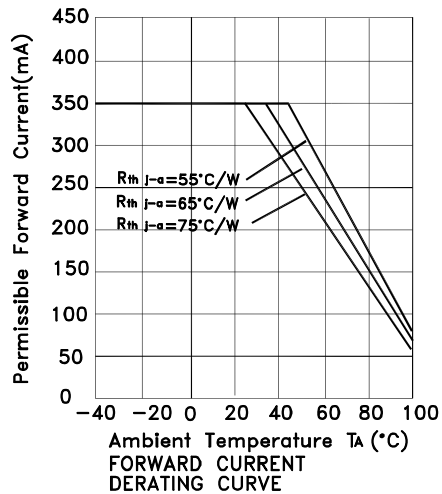
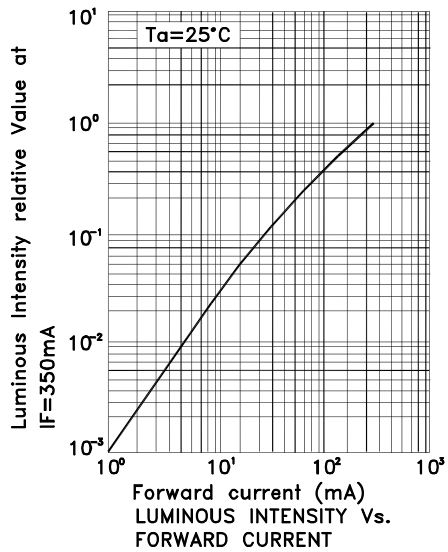
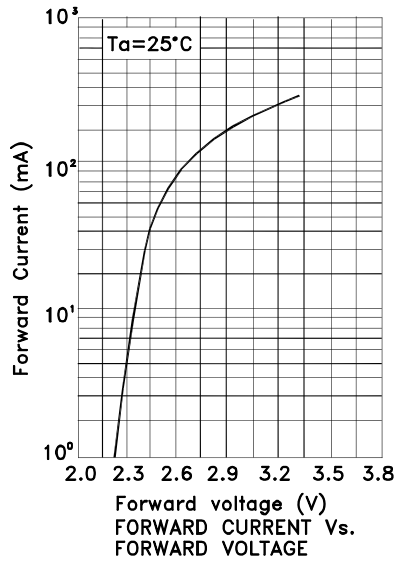
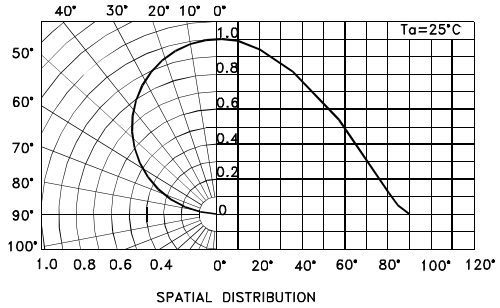
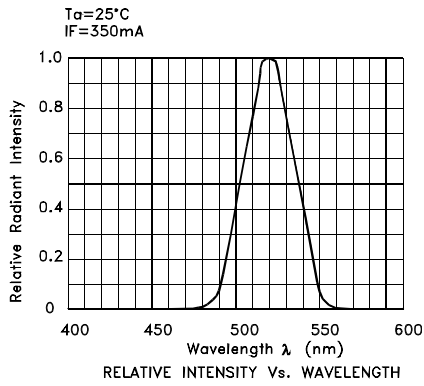

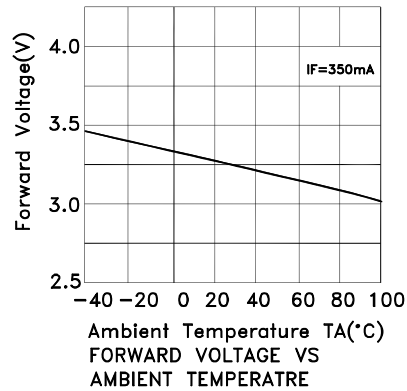
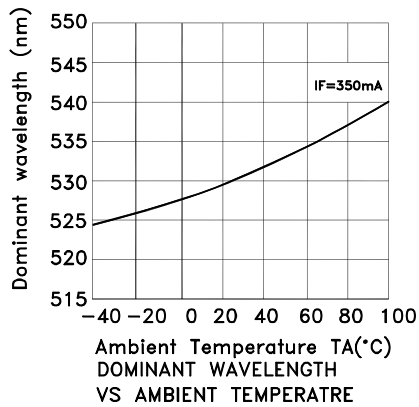
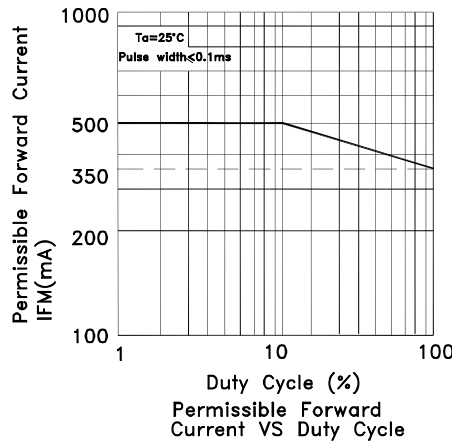

Reflow soldering is recommended and the soldering profile is shown below.  
Other soldering methods are not recommended as they might cause damage to the product.

Reflow Soldering Profile For Lead-free SMT Process.

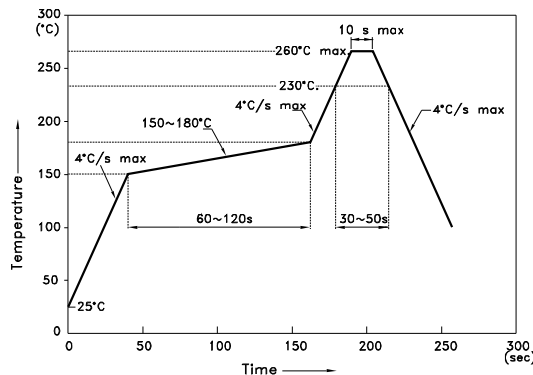

NOTES:

1. We recommend the reflow temperature  $245^{\circ}\text{C}(+/-5^{\circ}\text{C})$ . The maximum soldering temperature should be limited to  $260^{\circ}\text{C}$ .
2. Don't cause stress to the epoxy resin while it is exposed to high temperature.
3. Number of reflow process shall be 2 times or less.



### Packing & Label Specifications

### AT3535ZG10ZS-RV

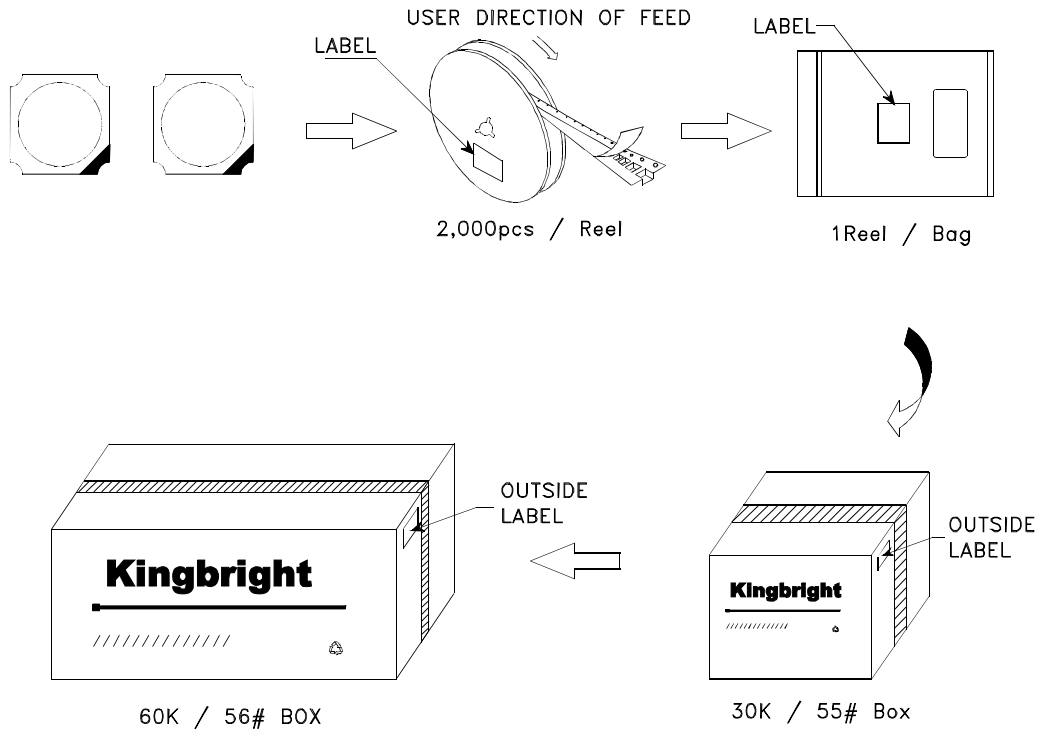

<h1>Kingbright</h1>	
P/NO: AT3535xxx	
QTY: 2,000 pcs	Q.C. <span style="border: 1px solid black; border-radius: 50%; padding: 2px;">Q C xx xx xxxx PASSED</span>
S/N: XXXX	
CODE: XXX	
LOT NO:	
 <small>XXXXXXXXXXXXXXXXXXXX</small>	
RoHS Compliant	

#### Packaging:

- 1.The LEDs are packed in cardboard boxes after taping.
- 2.The label on the minimum packing unit shows: Part Number, Lot Number, Ranking, Quantity.
- 3.In order to protect the LEDs from mechanical shock, we pack them in cardboard boxes for transportation.
- 4.The LEDs may be damaged if the boxes are dropped or receive a strong impact against them, so precautions must be taken to prevent any damage.
- 5.The boxes are not water resistant and therefore must be kept away from water and moisture.
- 6.When the LEDs are transported, we recommend that you use the same packing methods as Kingbright's.

### JEDEC Moisture Sensitivity:

Level	Floor Life		Soak Requirements			
			Standard		Accelerated Equivalent	
	Time	Conditions	Time (hours)	Conditions	Time (hours)	Conditions
2a	4 weeks	≤ 30 °C / 60% RH	696 <sup>2</sup> + 5 / - 0	30 °C / 60% RH	120 + 1 / - 0	60 °C / 60% RH

Notes:

- CAUTION - The "accelerated equivalent" soak requirements **shall not** be used until correlation of damage response, including electrical, after soak and reflow is established with the "standard" soak requirements or if the known activation energy for diffusion is 0.4 - 0.48 eV. Accelerated soak times may vary due to material properties, e.g., mold compound, encapsulant, etc. JEDEC document JESD22-A120 provides a method for determining the diffusion coefficient.
- The standard soak time includes a default value of 24 hours for semiconductor manufacturer's exposure time (MET) between bake and bag and includes the maximum time allowed out of the bag at the distributor's facility.  
If the actual MET is less than 24 hours the soak time may be reduced. For soak conditions of 30 °C/60% RH the soak time is reduced by one hour for each hour the MET is less than 24 hours. For soak conditions of 60 °C/60% RH, the soak time is reduced by one hour for each five hours the MET is less than 24 hours.  
If the actual MET is greater than 24 hours the soak time must be increased. If soak conditions are 30 °C/60% RH, the soak time is increased one hour for each hour that the actual MET exceeds 24 hours. If soak conditions are 60 °C/60% RH, the soak time is increased one hour for each five hours that the actual MET exceeds 24 hours.
- Supplier may extend the soak times at their own risk.

### ESD Protection During Production

Electric static discharge can result when static-sensitive products come in contact with the operator or other conductors.

The following procedures may decrease the possibility of ESD damage:

- Minimize friction between the product and surroundings to avoid static buildup.
- All production machinery and test instruments must be electrically grounded.
- Operators must wear anti-static bracelets.
- Wear anti-static suit when entering work areas with conductive machinery.
- Set up ESD protection areas using grounded metal plating for component handling.
- All workstations that handle IC and ESD-sensitive components must maintain an electrostatic potential of 150V or less.
- Maintain a humidity level of 50% or higher in production areas.
- Use anti-static packaging for transport and storage.
- All anti-static equipment and procedures should be periodically inspected and evaluated for proper functionality.

### Heat Generation:

- Thermal design of the end product is of paramount importance. Please consider the heat generation of the LED when making the system design. The coefficient of temperature increase per input electric power is affected by the thermal resistance of the circuit board and density of LED placement on the board, as well as other components. It is necessary to avoid intense heat generation and operate within the maximum ratings given in this specification.
- Please determine the operating current with consideration of the ambient temperature local to the LED and refer to the plot of Permissible Forward current vs. Ambient temperature on CHARACTERISTICS in this specification. Please also take measures to remove heat from the area near the LED to improve the operational characteristics on the LED.
- The equation ① indicates correlation between  $T_j$  and  $T_a$ , and the equation ② indicates correlation between  $T_j$  and  $T_s$

$$T_j = T_a + R_{thj-a} * W \quad \text{①}$$

$$T_j = T_s + R_{thj-s} * W \quad \text{②}$$

$T_j$  = dice junction temperature: °C

$T_a$  = ambient temperature: °C

$T_s$  = solder point temperature: °C

$R_{thj-a}$  = heat resistance from dice junction temperature to ambient temperature : °C/ W

$R_{thj-s}$  = heat resistance from dice junction temperature to  $T_s$  measuring point : °C/ W

$W$  = inputting power (IFx VF) : W

### Handling Precautions

Compare to epoxy encapsulant that is hard and brittle, silicone is softer and flexible. Although its characteristic significantly reduces thermal stress, it is more susceptible to damage by external mechanical force.

As a result, special handling precautions need to be observed during assembly using silicone encapsulated LED products. Failure to comply might leads to damage and premature failure of the LED.

1. Handle the component along the side surfaces by using forceps or appropriate tools.

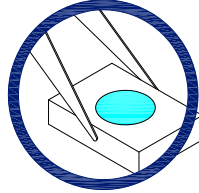

2. Do not directly touch or handle the silicone lens surface. It may damage the internal circuitry.

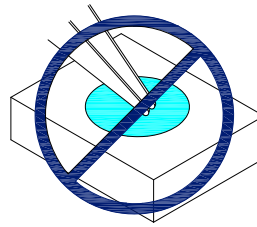
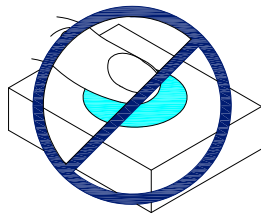

3. Do not stack together assembled PCBs containing exposed LEDs. Impact may scratch the silicone lens or damage the internal circuitry.

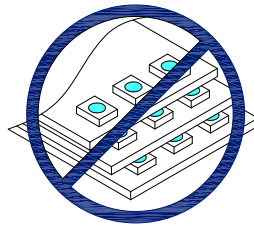

4. The outer diameter of the SMD pickup nozzle should not exceed the size of the LED to prevent air leaks. The inner diameter of the nozzle should be as large as possible.
5. A pliable material is suggested for the nozzle tip to avoid scratching or damaging the LED surface during pickup.
6. The dimensions of the component must be accurately programmed in the pick-and-place machine to insure precise pickup and avoid damage during production.

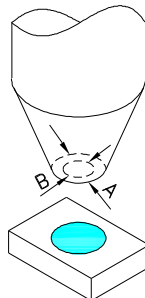



### Designing the Position of LED on a Board.

1.No twist/warp/bent/or other stress shall be applied to the board after mounting LED with solder to avoid a crack of LED package.

Refer to the following recommended position and direction of LED.

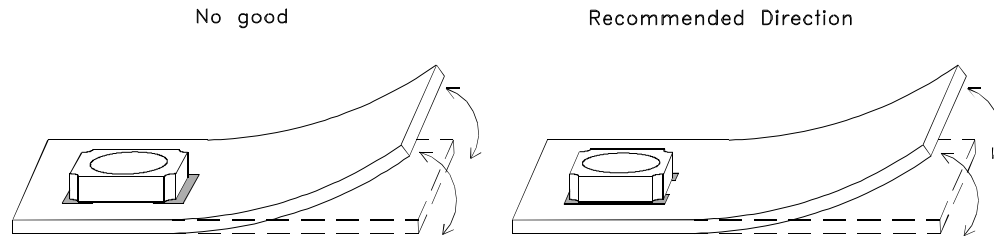

Appropriate LED mounting is to place perpendicularly against the stress affected side.

2.Dependent on the position and direction of LED,the mechanical stress on the LED package can be changed.

Refer to the following figure.

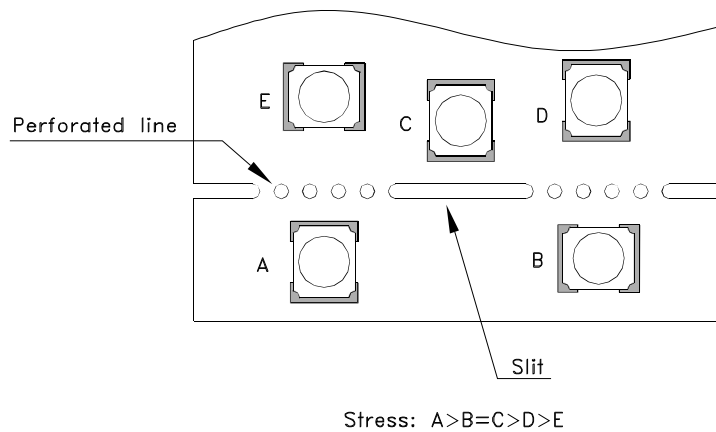

3.Do not split board by hand.Split with exclusive special tool.

4.If an aluminum circuit board is used,a large stress by thermal shock might cause a solder crack.

For this reason,it is recommended an appropriate verification should be taken before use.

### Reliability Test Items And Conditions

The reliability of products shall be satisfied with items listed below

**Lot Tolerance Percent Defective (LTPD) : 10%**

No.	Test Item	Test Conditions	Test Times / Cycles	Number of Damaged
1	Continuous Operating Test	$T_a = 25\text{ }^\circ\text{C}$ , $I_F = 350\text{ mA}$ Tested with standard circuit board*	1000 hrs	0/22
2	High Temperature Operating Test	$T_a = 100\text{ }^\circ\text{C}$ , $I_F = 60\text{ mA}$ (note)	1000 hrs	0/22
3	Low Temperature Operating Test	$T_a = -40\text{ }^\circ\text{C}$ , $I_F = 350\text{ mA}$ Tested with standard circuit board*	1000 hrs	0/22
4	High Temperature and Humidity Storage Operating Test	$T_a = 85\text{ }^\circ\text{C}$ , $RH = 85\%$ , $I_F = 110\text{ mA}$ (note)	1000 hrs	0/22
5	Temperature Cycling Test	High temp: $+100\text{ }^\circ\text{C}$ 30 mins ∩ R.T: 5 mins ∩ Low temp: $-40\text{ }^\circ\text{C}$ 30 mins ∩ R.T: 5 mins	10 cycles	0/22
6	Thermal Shock Test	High temp: $+100\text{ }^\circ\text{C}$ 5 mins ∩ Low temp: $-40\text{ }^\circ\text{C}$ 5 mins	1000 cycles	0/22
7	Soldering resistance Test	$T_{\text{slid}} = 260\text{ }^\circ\text{C}$ , 10 secs	10 secs	0/22

Note: Thermal resistance of LED with Kingbright circuit board :  $R_{th-j-a} = 75\text{ }^\circ\text{C/W}$

### Failure Criteria

Item	Symbol	Test Conditions	Criteria for Judgement	
			Min.	Max.
Forward Voltage	$V_F$	$I_F = 350\text{ mA}$	-	Initial Level x 1.1
Luminous Flux	$\Phi_v$	$I_F = 350\text{ mA}$	Initial Level x 0.7	-

Note: The test is performed after the board is cooled down to the room temperature.