

High Luminous Efficacy Warm White
Power LedFlex™ Emitter

LZ4-00WW15



Key Features

- High Luminous Efficacy 15W Warm White LED
- Unique package design with ceramic substrate, integrated glass lens and Flex PCB
- New industry standard for Lumen Maintenance (> 90% at 100,000 Hours)
- Extremely low Thermal Resistance (2.5°C/W)
- Isolated thermal path - electrical connections on Flex PCB
- Mount directly to heatsink - MCPCB not required
- Exceptional spatial color uniformity across radiation pattern
- Industry's highest Luminous Flux density
- High ESD protection (> 8 kV HBM)
- JEDEC Level 2 Moisture Sensitivity Level
- Lead (Pb) free and RoHS compliant

Typical Applications

- General Lighting
- Museum Lighting
- Retail & Display Lighting
- Hospitality Lighting
- Accent & Task Lighting
- Architectural Detail Lighting

Description

LedEngin's LZ4-00WW15 Warm White Power LedFlex™ emitter is capable of 15W power dissipation and provides exceptional luminous flux density. The LZ4-00WW15 offers ultimate design flexibility with separate electrical and thermal paths. The thermal contact can be mounted directly to a heatsink, eliminating the requirement for a MCPCB. The Anode and Cathode contacts are remotely located on the Flex PCB, allowing for connection versatility and unobstructed access to the optics. LedEngin's patent-pending thermally insulated phosphor layer provides for exceptional spatial color uniformity across the radiation pattern and a consistent CCT over time and temperature. The patent-pending design has unparalleled thermal and optical performance. The high quality materials used in the package are chosen to optimize light output and minimize stresses which results in monumental reliability and lumen maintenance.

Table of Contents

Product Nomenclature	3
IPC/JEDEC Moisture Sensitivity	3
Average Lumen Maintenance Projections	3
Luminous Flux Binning.	4
Forward Voltage Binning	4
Warm White Chromaticity Binning	5
Absolute Maximum Ratings	6
Optical Characteristics	6
Electrical Characteristics	6
Mechanical Dimensions	7
Typical Radiation Pattern	8
Typical Relative Spectral Power Distribution	8
Typical Relative Light Output	9
Typical Relative Light Output over Temperature	9
Typical Forward Current Characteristics	10
Current Derating Curves	10
Company Information	11

Product Nomenclature

The LZ Series part number designation is defined as follows:



Where:

A – designates the number of LED die in the package (“4” for 15W)

B – designates the package level (“0” for Emitter)

C – designates the radiation pattern (“0” for Lambertian)

D and E – designate the color (“WW” for Warm White: 2870 K < CCT < 3700 K)

F and G – designate the Power (“15” for 15W typical rating)

H – designates the Flux bin (See Table 2)

J and K – designate the CCT bin groups (see Figure 1 and Table 4)

L – designates the V_F bin (See Table 3)

Ordering information:

For ordering LedEngin products, please reference the base part number. The base part number represents any of the luminous flux, chromaticity groups, or forward voltage bins specified in the binning tables below. For ordering products with special bin selections, please contact a LedEngin sales representative or authorized distributor.

IPC/JEDEC Moisture Sensitivity Level

Table 1 - IPC/JEDEC J-STD-20 MSL Classification:

Level	Floor Life		Soak Requirements			
	Time	Conditions	Standard	Accelerated	Standard	Accelerated
	Time (hrs)	Conditions	Time (hrs)	Conditions	Time (hrs)	Conditions
2	1 Year	≤ 30°C/ 60% RH	168 +5/-0	85°C/ 60% RH	n/a	n/a

Notes for Table 1:

1. The standard soak time is the sum of the default value of 24 hours for the semiconductor manufacturer's exposure time (MET) between bake and bag and the floor life of maximum time allowed out of the bag at the end user of distributor's facility.

Average Lumen Maintenance Projections

Lumen maintenance generally describes the ability of a lamp to retain its output over time. The useful lifetime for solid state lighting devices (Power LEDs) is also defined as Lumen Maintenance, with the percentage of the original light output remaining at a defined time period.

Based on long-term WHTOL testing, LedEngin projects that the LZ Series will deliver, on average, 90% Lumen Maintenance at 100,000 hours of operation at a forward current of 1000 mA. This projection is based on constant current operation with junction temperature maintained at or below 125°C.

Luminous Flux Bins

Table 2:

Bin Code	Minimum Luminous Flux (Φ_V) @ $I_F = 1000\text{mA}$ ^[1,2] (lm)	Maximum Luminous Flux (Φ_V) @ $I_F = 1000\text{mA}$ ^[1,2] (lm)	Typical Luminous Flux (Φ_V) @ $I_F = 1500\text{mA}$ ^[2] (lm)
S	356	445	500
T	445	556	630
U	556	695	790

Notes for Table 2:

1. Luminous flux performance guaranteed within published operating conditions. LedEngin maintains a tolerance of $\pm 10\%$ on flux measurements.
2. Future products will have even higher levels of luminous flux performance. Contact LedEngin Sales for updated information.

Forward Voltage Bins

Table 3:

Bin Code	Minimum Forward Voltage (V_F) @ $I_F = 1000\text{mA}$ ^[1] (V)	Maximum Forward Voltage (V_F) @ $I_F = 1000\text{mA}$ ^[1] (V)
F	12.80	13.76
G	13.76	14.72
H	14.72	15.68
J	15.68	16.64

Notes for Table 3:

1. LedEngin maintains a tolerance of $\pm 0.04\text{V}$ for forward voltage measurements.

Warm White Chromaticity Groups

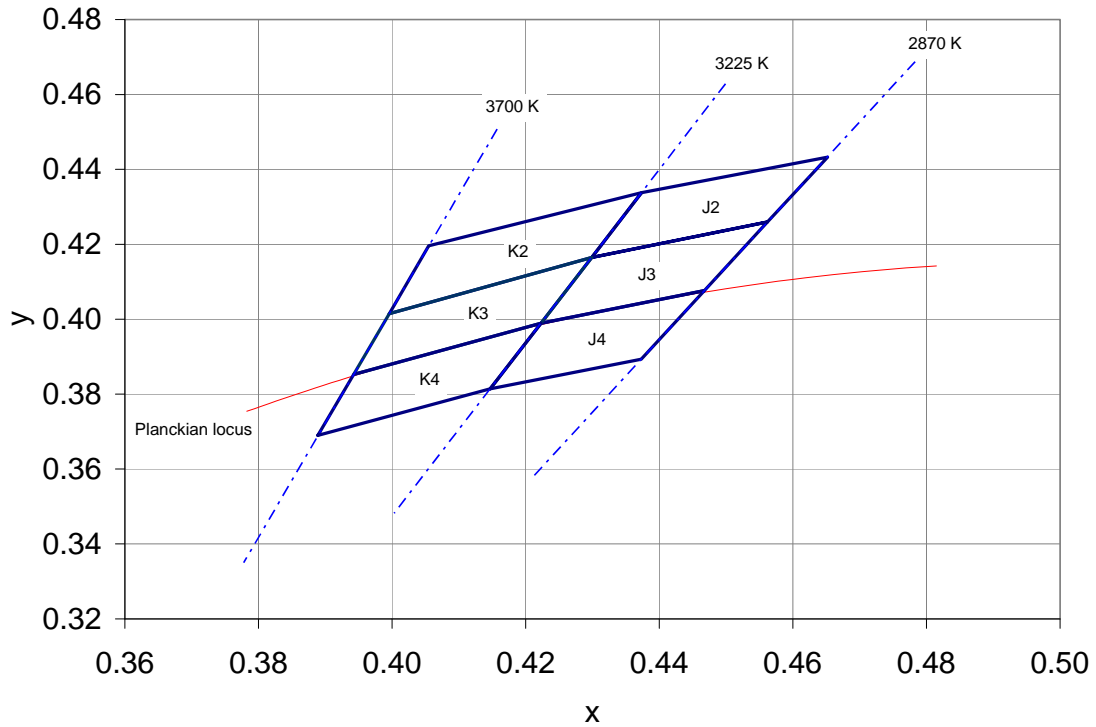

Figure 1: Standard Chromaticity Groups plotted on excerpt from the CIE 1931 (2°) x-y Chromaticity Diagram. Coordinates are listed below in Table 3.

Warm White Chromaticity Coordinates

Table 4:

Bin Code	x	y	Typical CCT (K)	Bin Code	x	y	Typical CCT (K)
K2	0.3996	0.4015	3450	J2	0.4299	0.4165	3050
	0.4299	0.4165			0.4562	0.4260	
	0.4374	0.4338			0.4652	0.4433	
	0.4055	0.4196			0.4374	0.4338	
K3	0.3996	0.4015	3450	J3	0.4299	0.4165	3050
	0.4299	0.4165			0.4562	0.4260	
	0.4223	0.3990			0.4468	0.4077	
	0.3943	0.3853			0.4223	0.3990	
K4	0.3889	0.3690	3450	J4	0.4147	0.3814	3050
	0.3943	0.3853			0.4223	0.3990	
	0.4223	0.3990			0.4468	0.4077	
	0.4147	0.3814			0.4373	0.3893	

Absolute Maximum Ratings

Table 5:

Parameter	Symbol	Value	Unit
DC Forward Current ^[1]	I_F	1500	mA
Peak Pulsed Forward Current ^[2]	I_{FP}	2000	mA
Reverse Voltage	V_R	See Note 3	V
Storage Temperature	T_{stg}	-40 ~ +150	°C
Junction Temperature	T_J	150	°C
Soldering Temperature	T_{sol}	260	°C
ESD Sensitivity ^[4]		> 8,000 V HBM Class 3B JESD22-A114-D	

Notes for Table 5:

- Maximum DC forward current is determined by the overall thermal resistance and ambient temperature. Follow the curves in Figure 8 for current derating.
- Pulse forward current conditions: Pulse Width \leq 10msec and Duty cycle \leq 10%.
- LEDs are not designed to be reverse biased.
- LedEngin recommends taking reasonable precautions towards possible ESD damages and handling the LZ4-00WW15 in an electrostatic protected area (EPA). An EPA may be adequately protected by ESD controls as outlined in ANSI/ESD S6.1.

Optical Characteristics @ $T_C = 25^\circ\text{C}$

Table 6:

Parameter	Symbol	Typical	Unit
Luminous Flux (@ $I_F = 1000\text{mA}$)	Φ_V	400	lm
Luminous Flux (@ $I_F = 1500\text{mA}$)	Φ_V	500	lm
Correlated Color Temperature ^[1]	CCT	3100	K
Chromaticity Coordinates	x,y	0.430, 0.402	
Viewing Angle ^[2]	$2\Theta_{1/2}$	105	Degrees
Total Included Angle ^[3]	$\Theta_{0.9V}$	135	Degrees

Notes for Table 6:

- Typical Color Rendering Index (CRI) is 80.
- Viewing Angle is the off axis angle from emitter centerline where the luminous intensity is $\frac{1}{2}$ of the peak value.
- Total Included Angle is the total angle that includes 90% of the total luminous flux.

Electrical Characteristics @ $T_C = 25^\circ\text{C}$

Table 7:

Parameter	Symbol	Typical	Unit
Forward Voltage (@ $I_F = 1000\text{mA}$)	V_F	14.5	V
Forward Voltage (@ $I_F = 1500\text{mA}$)	V_F	15.1	V
Temperature Coefficient of Forward Voltage	$\Delta V_F/\Delta T_J$	-8.2	mV/°C
Thermal Resistance (Junction to Case)	$R\Theta_{J-C}$	2.5	°C/W

Mechanical Dimensions (mm)

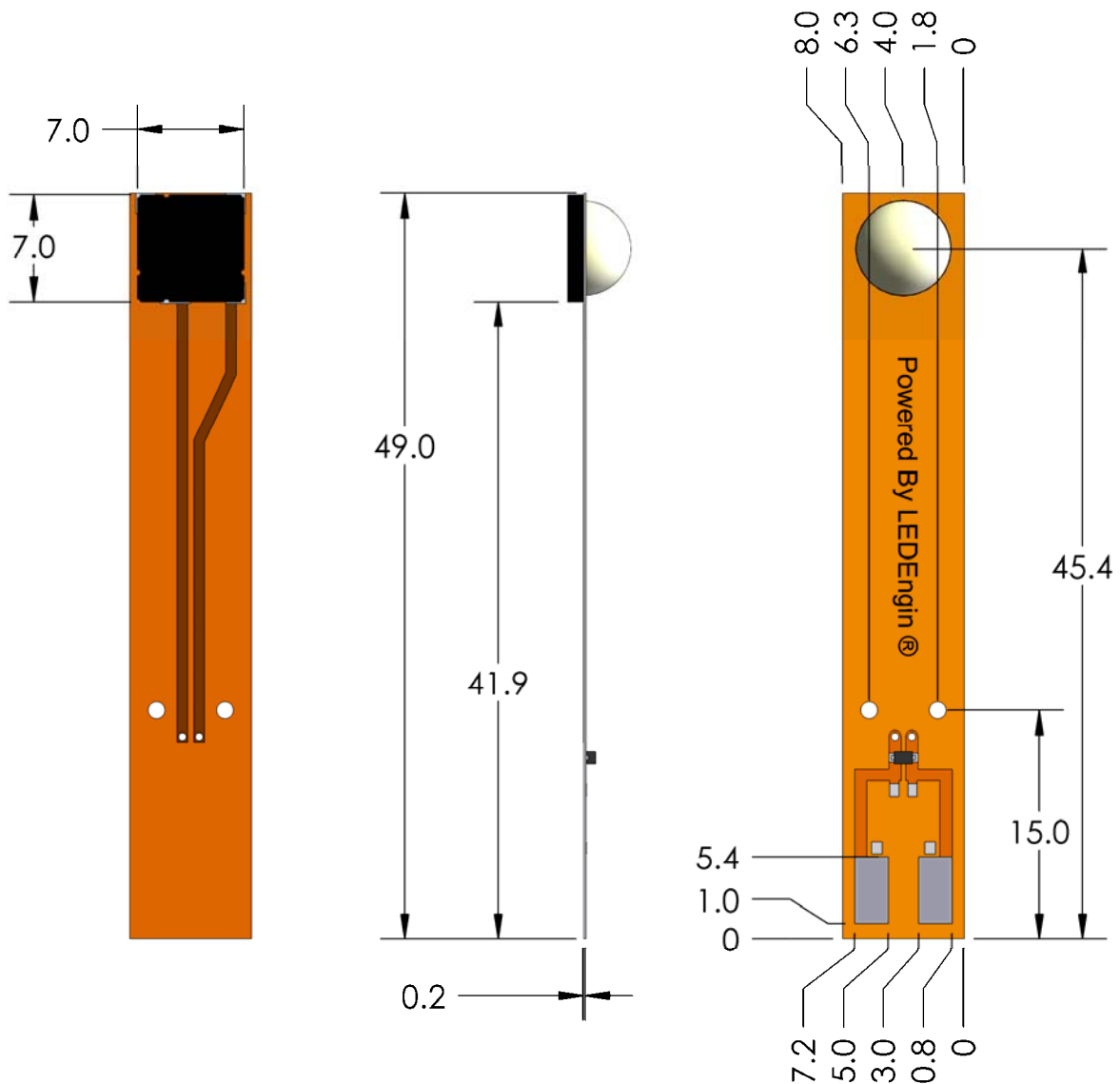

Figure 2: Package outline drawing.

Notes for Figure 2:

1. Unless otherwise noted, the tolerance = ± 0.20 mm.
2. Solder contact pads on Flex PCB are labeled "+" for Anode and "-" for Cathode.
3. LedEngin recommends using a thermally conductive adhesive when attaching Thermal Contact to a heat sink. Please contact LedEngin Sales Representative for recommended adhesives.

Typical Radiation Pattern

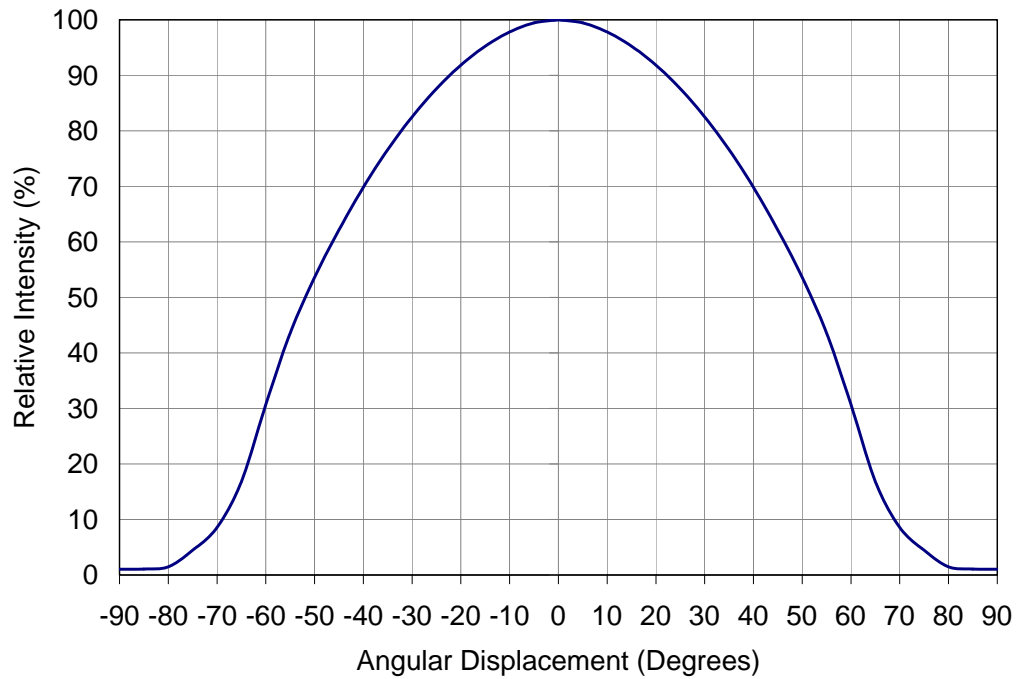

Figure 3: Typical representative spatial radiation pattern.

Typical Relative Spectral Power Distribution

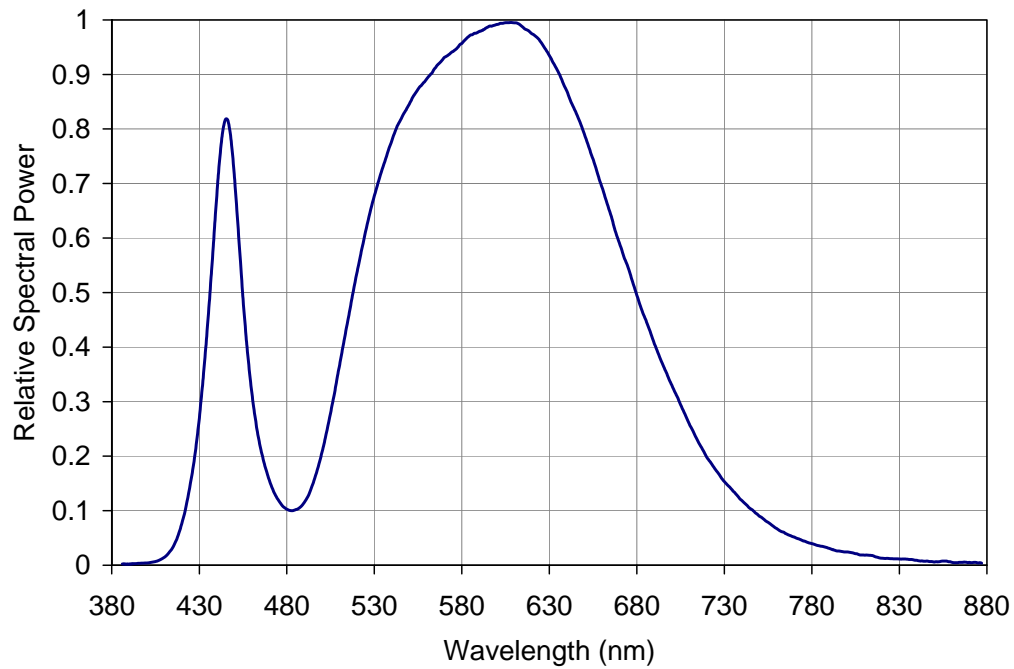

Figure 4: Relative spectral power vs. wavelength.

Typical Relative Light Output

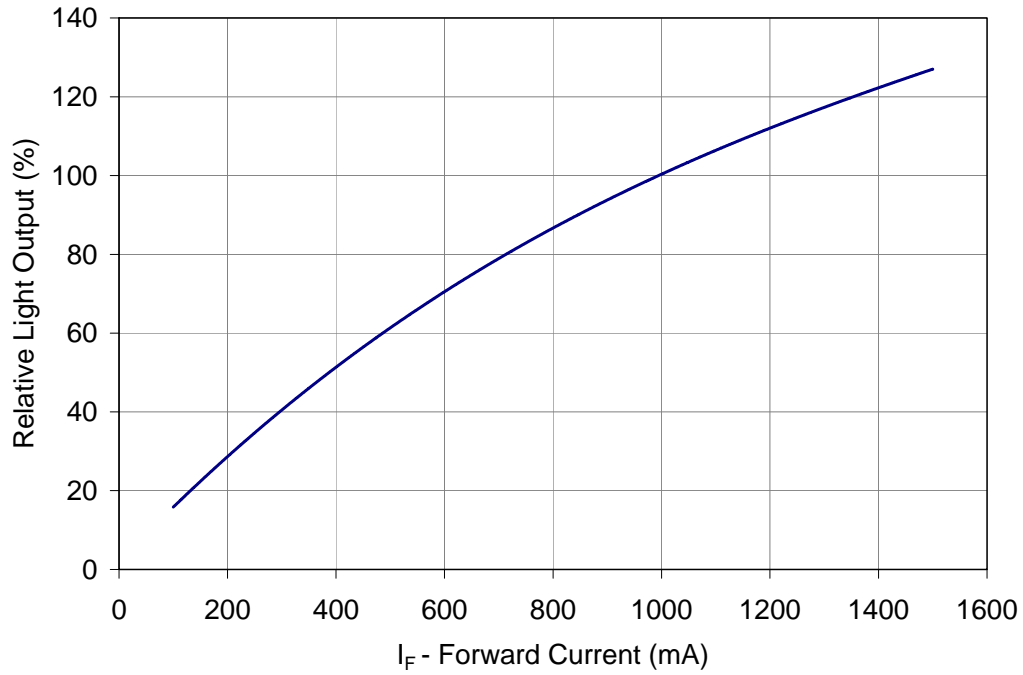

Figure 5: Typical relative light output vs. forward current @ T_C = 25°C.

Typical Relative Light Output over Temperature

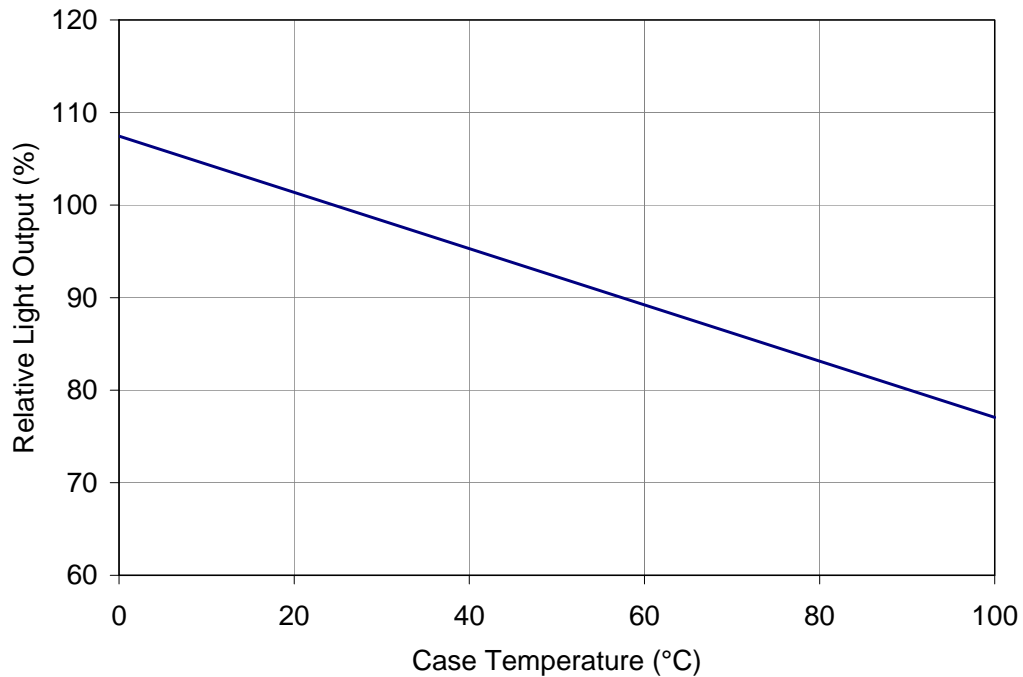

Figure 6: Typical relative light output vs. case temperature.

Typical Forward Current Characteristics

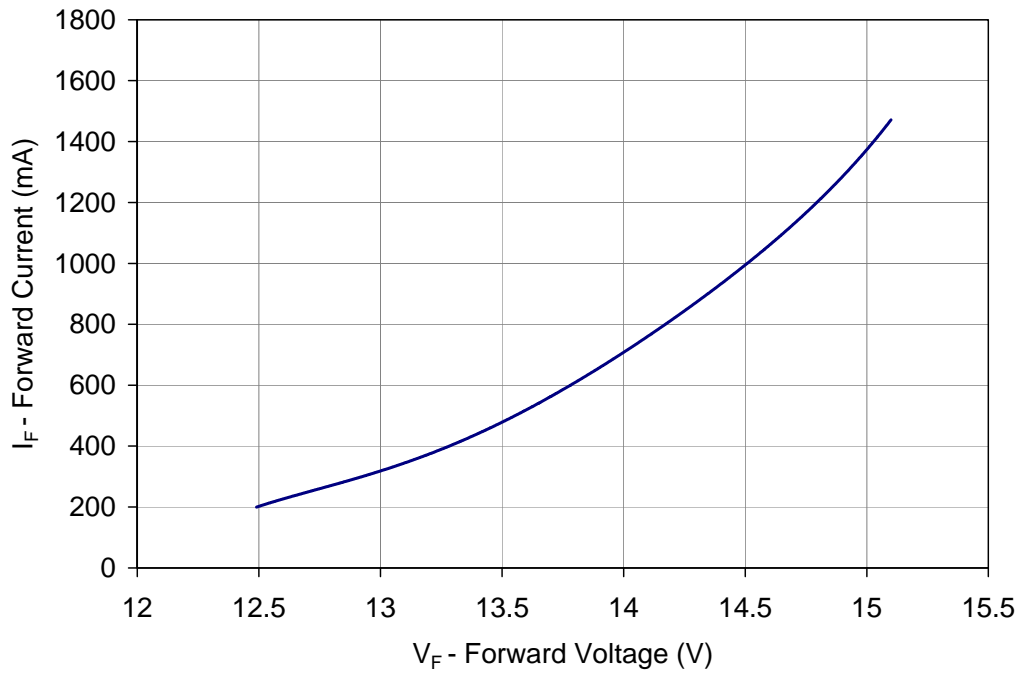

Figure 7: Typical forward current vs. forward voltage @ $T_C = 25^\circ\text{C}$.

Current Derating

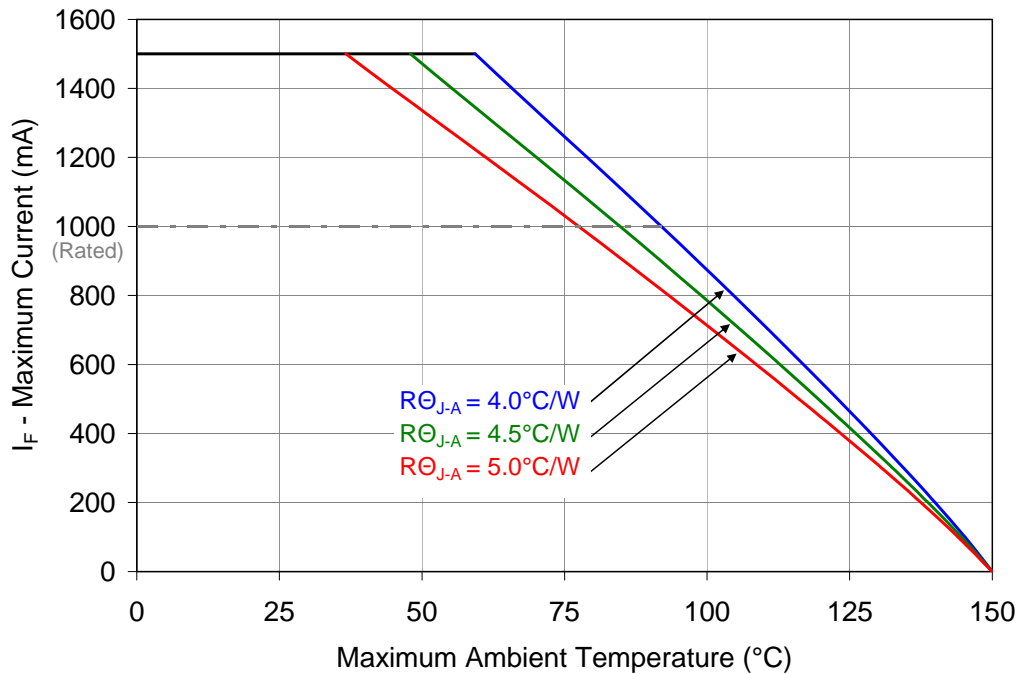

Figure 8: Maximum forward current vs. ambient temperature based on $T_{J(\text{MAX})} = 150^\circ\text{C}$.

Notes for Figure 8:

1. $R\theta_{J-C}$ [Junction to Case Thermal Resistance] for the LZ4-00WW15 is typically 2.5°C/W .
2. $R\theta_{J-A}$ [Junction to Ambient Thermal Resistance] = $R\theta_{J-C}$ + $R\theta_{C-A}$ [Case to Ambient Thermal Resistance].

Company Information

The LZ1-00WW15 Power LedFlex™ is developed, manufactured, and marketed by LedEngin, Inc., located in Santa Clara, CA. LedEngin is a global leader in advanced high-power LED emitters and light-source modules. LedEngin provides total solutions from 3W to 15W in single packages with ultra-small footprints in all colors from Cool White, Warm White, Neutral White, Red, Green Blue, Amber, RGB, RGBA, Dental Blue and UV. LedEngin supports customers to generate solid-state lighting designs that conserve natural resources. LedEngin is focused on differentiated Ultra High-Brightness LED solutions for diverse global markets using its patent-pending package designs and manufacturing processes. LedEngin offers catalog as well as full custom solutions to enable flexible system designs for its customers. LedEngin is dedicated to long-term win-win partnering with its customers and suppliers.

LedEngin reserves the right to make changes to improve performance without notice.

Please contact Sales@ledengin.com or (408) 492-0620 for more information.