

PhlatLight[®] LED Illumination Products

CBT-120 Series

Features

- Extremely high optical output: Over 1225 Red Lumens
Over 2000 Green lumens
Over 470 Blue Lumens
- High thermal conductivity package - junction to heat sink thermal resistance of only 0.7 °C/W
- Photonic lattice technology for very high surface brightness and uniform emission
- Large, monolithic chip with surface emitting area of 12 mm²
- High luminous efficacy
- Lumen maintenance of greater than 70% after 60,000 hours
- Environmentally friendly: RoHS compliant
- Variable drive currents: less than 1 A through 30 A
- Currently available in Red, Green and Blue; other colors to follow

Applications

- Entertainment
- Architectural Lighting
- Medical Lighting
- Spot Lighting
- Fiber Coupled Illumination
- Emergency Vehicle Lighting
- Machine Vision
- Projection Systems
- Displays and Signage
- General Illumination

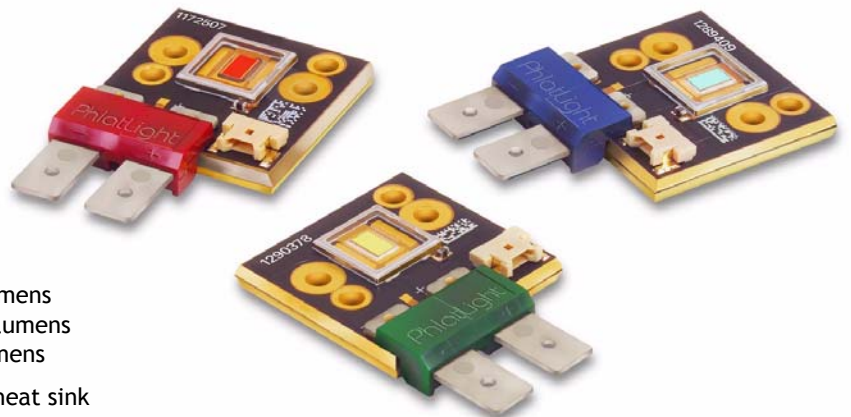

PhlatLight[®] LEDs, based on Photonic Lattice Technology, enable a new class of illumination applications.

Table of Contents

Technology Overview.....	2
Test Specifications.....	2
PhlatLight Bin Codes.....	3
Product Shipping and Labeling Information.....	4
Optical and Electrical Characteristics	5
Flux and Spectral Characteristics vs. Temperature	9
Lifetime and Lumen Maintenance	9
Spectral Characteristics.....	9
Radiation Patterns	10
Thermal Resistance	10
Mechanical Dimensions.....	11
Ordering Information	12

Technology Overview

PhlatLight LEDs benefit from a suite of innovations in the fields of chip technology, packaging, and thermal management. These breakthroughs allow illumination designers to achieve efficient light engine designs and deliver high brightness solutions.

PhlatLight Technology

The name PhlatLight is derived from Photonic Lattice. PhlatLight devices use photonic lattice patterns to extract more light from the LED chip, and to create radiation patterns that are collimated compared to typical Lambertian emitters. Optical collection efficiencies improve and optical designs become simplified with a more collimated light source.

Photonic lattice technology creates true surface emission from the source, which enables large area LED chips with uniform brightness over the entire LED chip surface. The optical power and brightness produced by these large monolithic chips enable solutions which replace arc and halogen lamps where arrays of traditional high power LEDs cannot.

Packaging Technology

Thermal management is critical in high power LED applications. With a thermal resistance from junction to heat sink of 0.7 °C/W, PhlatLight CBT-120 devices have the lowest thermal resistance of any LED on the market. This allows the LED to be driven at higher current densities while maintaining a low junction temperature, thereby resulting in brighter and longer lifetimes. The package is easy to use, and ready to be mounted in the lighting system.

Reliability

Designed from the ground up, PhlatLight LEDs are one of the most reliable light sources in the world today. PhlatLight LEDs have passed a rigorous suite of environmental and mechanical stress tests, including mechanical shock, vibration, temperature cycling and humidity, and have been fully qualified for use in extreme high power and high current applications. With very low failure rates and median lifetimes that are well above 60,000 hours, PhlatLight LEDs are ready for the most demanding applications.

Environmental Benefits

PhlatLight LEDs help reduce power consumption and the amount of hazardous waste entering the environment. All PhlatLight products manufactured by Luminus are RoHS compliant and free of hazardous materials, including lead and mercury.

Understanding PhlatLight Test Specifications

Every PhlatLight LED device is fully tested to ensure that it meets the high quality standards of Luminus' products.

Testing Temperature

PhlatLight LEDs are measured in such a way that the characteristics reported agree with how the devices will actually perform when incorporated into a system. This measurement is accomplished by mounting the devices on a 40° C heat sink and allowing the device to reach thermal equilibrium while fully powered. Only after the device reaches equilibrium are the measurements taken. This method of measurement ensures that PhlatLight LEDs perform in the field just as they are specified.

Multiple Operating Points (4.2 A, 18 A, 30 A)

The tables on the following pages provide typical optical and electrical characteristics. Since the LEDs can be operated over a wide range of drive conditions (currents from <1A to 30 A, and duty cycle from <1% to 100%) multiple drive conditions are listed.

PhlatLight CBT-120 devices are production specified at 18 A. The values shown at 4.2 A and 30 A are for additional reference at other possible drive conditions.

PhlatLight CBT-120 Bins

PhlatLight LEDs are specified for luminous flux and wavelength at a drive current of 18 A (1.5 A/mm²) and placed into one of the following luminous flux (FF) and wavelength (WW) bins:

Blue Bins

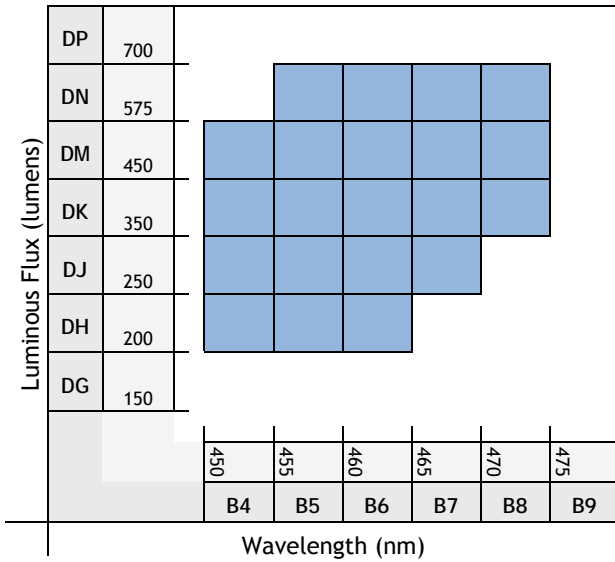

Green Bins

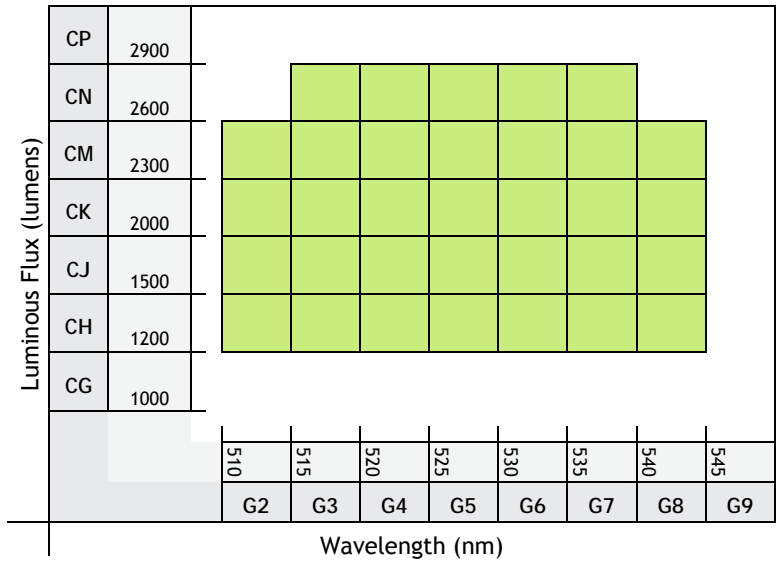

Red Bins

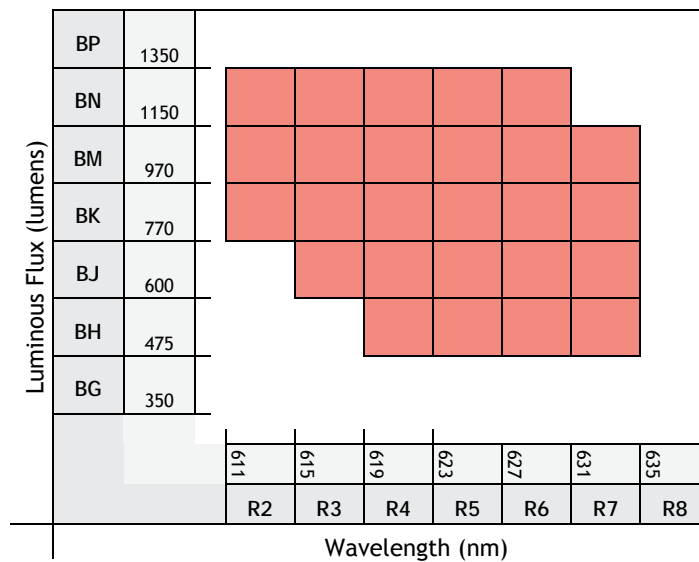

PhlatLight Product Shipping and Labeling Information

All PhlatLight products are packaged and labeled with their respective bin as outlined in the tables on page 3. Modules are packaged in trays of 10, with each package only containing one bin. The part number designation is as follows:

CBT — 120 — X — C11 — FF — WW

Product Family	Chip Area	Color	Package Configuration	Flux Bin	Wavelength Bin
CBT: Chip on Board	120: 12 mm ²	R: Red	C11: 28 x 27 mm board	See page 3 for bins	See page 3 for bins
		G: Green			
		B: Blue			

Example: The part number CBT-120-R-C11-BM-R4 refers to a red, CBT-120 module, with a flux range of 970-1150 lumens and a wavelength range of 619 nm to 623 nm.

Note: Some flux and wavelength bins may have limited availability. Application specific bin kits, consisting of multiple bins, may be available. For ordering information, please refer to page 12 and reference the PhlatLight Binning and Labeling document.

Reference Optical and Electrical Characteristics ($T_{\text{heat sink}} = 40\text{ }^{\circ}\text{C}$)¹

Red					
Drive Condition ²		4.2 A Continuous	18 A Continuous	30A Pulsed 50% D.F. ³	
Parameter	Symbol	Values ⁴			Unit
Current Density	j	0.35	1.5	2.5	A/mm ²
Forward Voltage	V _{F min}		2.0		V
	V _F	1.8	2.3	2.6	V
	V _{F max}		2.6		V
Luminous Flux ⁵	Φ _{V typ}	190	825	1400	lm
Radiometric Flux	Φ _R	1.3	5.5	8.0	W
Luminous Efficacy	η	26	20	18	lm/W
Dominant Wavelength ⁶	λ _d	622	623	623	nm
Peak Wavelength	λ _p	625	628	629	nm
Color Saturation	-	1.00	1.00	1.00	-
FWHM	Δλ _{1/2}	16	19	20	nm
Chromaticity Coordinates ^{7,8}	x	0.695	0.699	0.702	-
	y	0.305	0.301	0.298	-

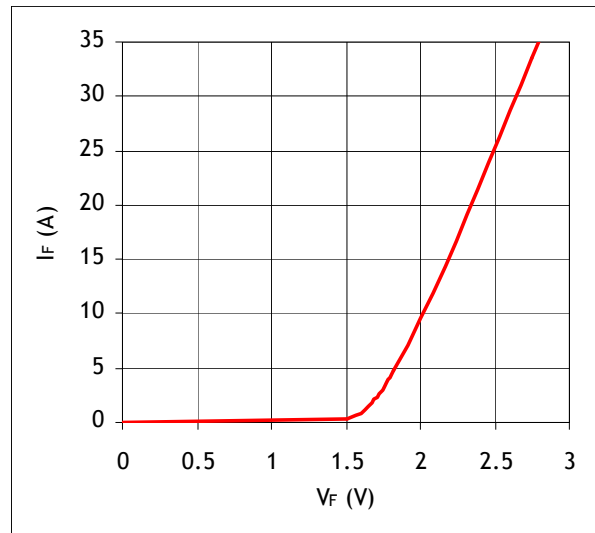
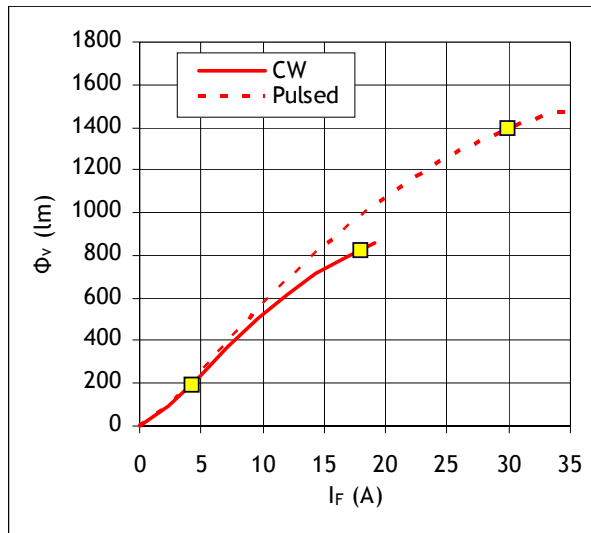

Yellow squares indicate reference drive conditions

Reference Optical and Electrical Characteristics ($T_{\text{heat sink}} = 40\text{ }^{\circ}\text{C}$)¹

Green					
Drive Condition ²		4.2 A Continuous	18 A Continuous	30A Pulsed 50% D.F. ³	
Parameter	Symbol	Values ⁴			Unit
Current Density	j	0.35	1.5	2.5	A/mm ²
Forward Voltage	V _{Fmin}		3.8		V
	V _F	3.5	4.3	4.9	V
	V _{Fmax}		4.9		V
Luminous Flux ⁵	Φ _v	800	2100	3100	lm
Radiometric Flux	Φ _r	1.6	4.1	6.3	W
Luminous Efficacy	η	55	28	21	lm/W
Dominant Wavelength ⁶	λ _d	535	528	526	nm
Peak Wavelength	λ _p	530	524	521	nm
Color Saturation	-	0.91	0.83	0.79	-
FWHM	Δλ _{1/2}	35	39	40	nm
Chromaticity Coordinates ^{7,8}	x	0.205	0.175	0.161	-
	y	0.740	0.730	0.722	-

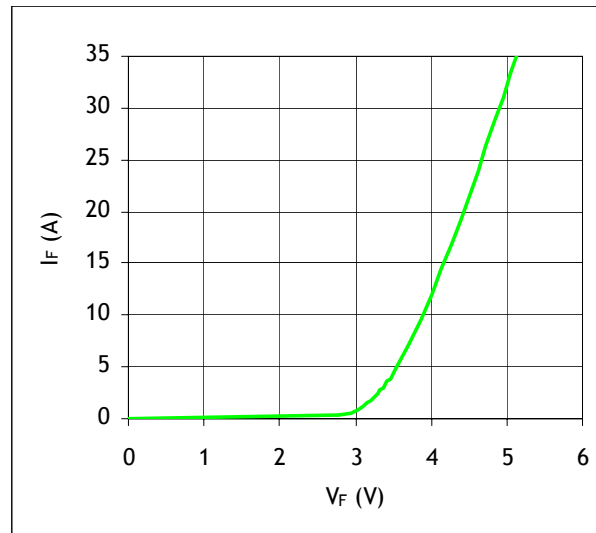
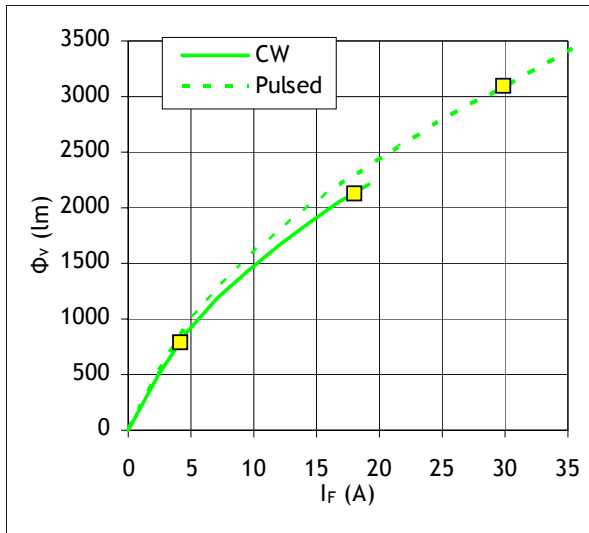

Yellow squares indicate reference drive conditions

Reference Optical and Electrical Characteristics ($T_{\text{heat sink}} = 40\text{ }^{\circ}\text{C}$)¹

Blue					
Drive Condition ²		4.2 A Continuous	18 A Continuous	30A Pulsed 50% D.F. ³	
Parameter	Symbol	Values ⁴			Unit
Current Density	j	0.35	1.5	2.5	A/mm ²
Forward Voltage	V _{Fmin}		3.5		V
	V _F	3.4	4.1	4.5	V
	V _{Fmax}		5.0		V
Luminous Flux ⁵	Φ _v	150	400	600	lm
Radiometric Flux	Φ _r	2.7	7.2	12.3	W
Luminous Efficacy	η	11	6	5	lm/W
Dominant Wavelength ⁶	λ _d	462	462	462	nm
Peak Wavelength	λ _p	459	460	460	nm
Color Saturation	-	0.99	0.99	0.99	-
FWHM	Δλ _{1/2}	22	25	27	nm
Chromaticity Coordinates ^{7,8}	x	0.142	0.142	0.142	-
	y	0.036	0.038	0.038	-

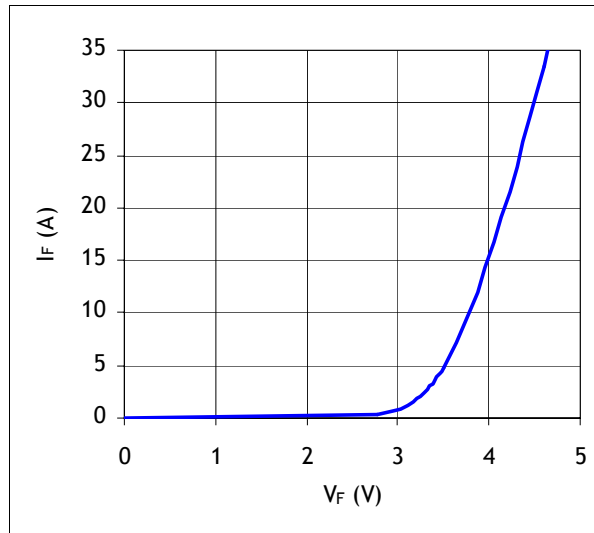
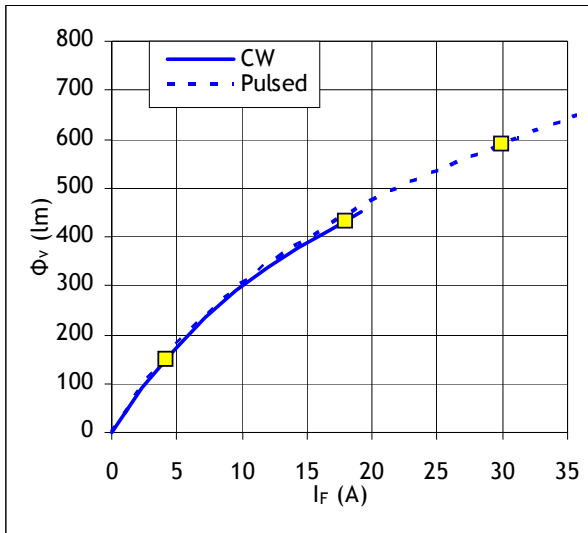

Yellow squares indicate reference drive conditions

Reference Optical and Electrical Characteristics ($T_{\text{heat sink}} = 40\text{ }^{\circ}\text{C}$)¹

Common Characteristics

	Symbol	Red	Green	Blue	Unit
Emitting Area		12.0	12.0	12.0	mm ²
Emitting Area Dimensions		4.6x2.6	4.6x2.6	4.6x2.6	mmxmm
Dynamic Resistance	Ω_{dyn}	0.03	0.04	0.02	Ω
Photometric Thermal Efficiency Coefficient		-0.96	-0.18	-0.007	%/ $^{\circ}\text{C}$
Radiometric Thermal Efficiency Coefficient		-0.52	-0.20	-0.17	%/ $^{\circ}\text{C}$
Forward Voltage Temperature Coefficient		-1.3	-4.6	-3.5	mV/ $^{\circ}\text{C}$

Absolute Maximum Ratings

	Symbol	Red	Green	Blue	Unit
Maximum Current ⁹		36	36	36	A
Maximum Junction Temperature ¹⁰	T_{jmax}	125	150	150	$^{\circ}\text{C}$
Storage Temperature Range		-40/+100	-40/+100	-40/+100	$^{\circ}\text{C}$

Note 1: All ratings are based on operation with a constant heat sink temperature $T_{\text{hs}} = 40^{\circ}\text{C}$. See Thermal Resistance section for T_{hs} definition.

Note 2: Listed drive conditions are typical for common applications. PhlatLight CBT-120 devices can be driven at currents ranging from <1 A to 30 A and at duty cycles ranging from 1% to 100%. Drive current and duty cycle should be adjusted as necessary to maintain the junction temperature desired to meet application lifetime requirements.

Note 3: Current Density of 2.5 A/mm². Rated at 50% duty cycle and Pulsed operation frequency of $f > 360\text{Hz}$;

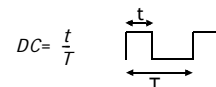

Note 4: Unless otherwise noted, values listed are typical. Devices are production tested and specified at 18 A. Values at 4.2 A and 30 A are for reference only.

Note 5: Total flux from emitting area at listed dominant wavelength. Reported performance is included to show trends for a selected power level. For specific minimum and maximum values, use bin tables. For product roadmap and future performance of devices, contact Luminus.

Note 6: Minimum and Maximum Dominant Wavelengths are based on typical values +/- 5nm for Red, +/- 8nm for Green and +/- 6nm for Blue.

Note 7: In CIE 1931 chromaticity diagram coordinates, normalized to $X+Y+Z=1$.

Note 8: For reference only.

Note 9: Luminus PhlatLight LEDs are designed for operation to an absolute maximum current as specified above. Product lifetime data is specified at recommended forward drive currents. Sustained operation at or beyond absolute maximum currents will result in a reduction of device life ime compared to recommended forward drive currents. Actual device lifetimes will also depend on junction temperature. Refer to the lifetime derating curves for further information. In pulsed operation, rise time from 10-90% of forward current should be larger than 0.5 microseconds.

Note 10: Lifetime dependent on LED junction temperature. Input power and thermal system must be properly managed to ensure lifetime. See charts on pg 7 for further information.

Note 11: Special design considerations must be observed for operation under 1 A. Please contact Luminus for further information.

Note 12: Caution must be taken not to stare at the light emitted from these LEDs. Under special circumstances, the high intensity could damage the eye.

Light Output and Spectral Characteristics Over Heat Sink Temperature

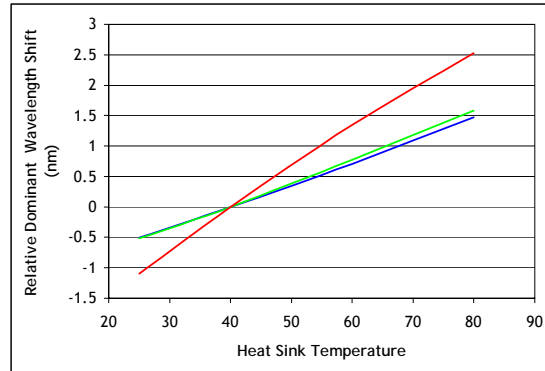
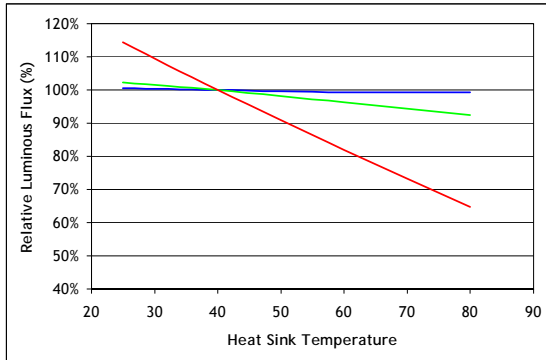

Median Lifetime Estimate vs. T_j^{13}

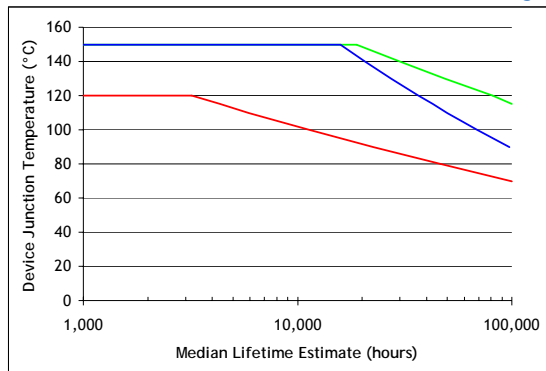

Lumen Maintenance¹⁴

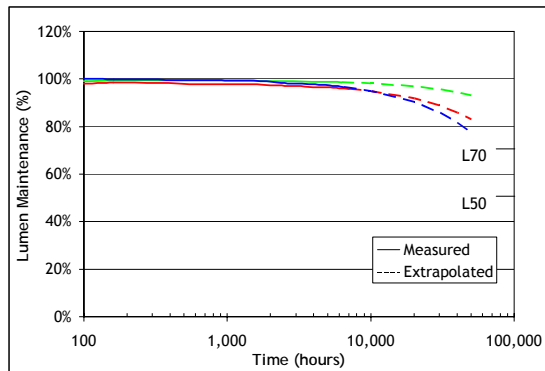

Typical Spectrum¹⁵

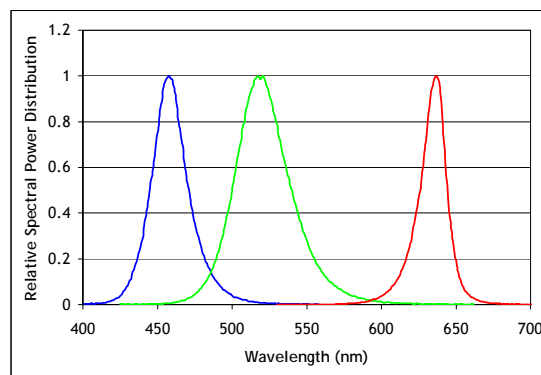

Note 13. Median lifetime estimate as a function of junction temperature at 1.5A/mm² in continuous operation. Lifetime defined as time to 70% of initial intensity. Based on preliminary lifetime test data. Data can be used to model failure rate over typical product lifetime.

Note 14. Lumen maintenance vs. time at 1.5A/mm² in continuous operation, Red junction temperature of 70°C, Green junction temperatures of 120°C, Blue junction temperatures of 100°C.

Note 15. Typical spectrum at current density of 1.5 A/mm² in continuous operation.

Typical Radiation Pattern

Typical Polar Radiation Pattern for Blue and Green

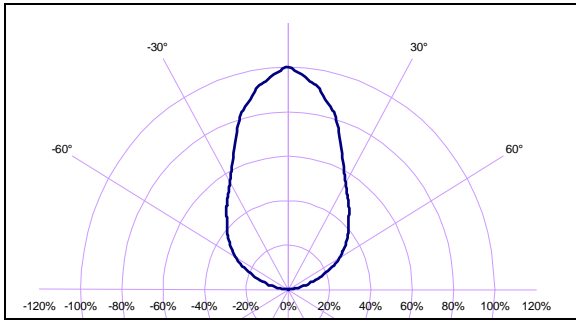

Typical Polar Radiation Pattern for Red

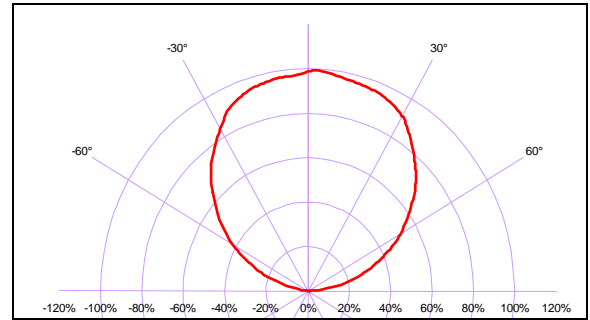

Thermal Resistance

T_j Die Junction
 T_b Window Frame
 T_{hs} Copper core-board
 T_a Heat sink
 T_{ref} Thermistor
 Window
 Window Frame
 Thermistor
 Copper core-board
 Thermal interface material
 Heat sink

T_{hs} definition = 3 mm from core-board

Typical Thermal Resistance

$R_{\theta j-b}^1$	0.61 °C/W
$R_{\theta b-hs}^1$	0.12 °C/W
$R_{\theta j-hs}^2$	0.73 °C/W
$R_{\theta j-ref}^1$	0.64 °C/W

Note 1: Thermal resistance values are based on FEA model results correlated to measured $R_{\theta j-hs}$ data
 Note 2: Thermal Resistance is based on eGraf 1205 Thermal interface.

Thermistor Information

The thermistor used in PhlatLight devices mounted on core-boards is from Murata Manufacturing Co. The global part number is NCP15XH103J03RC. Please see <http://www.murata.com/> for details on calculating thermistor temperature.

For more information on use of the thermistor, please contact Luminus directly.

Electrical Pinout

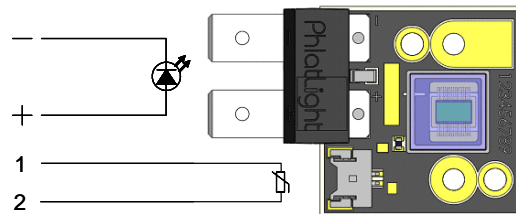

Mechanical Dimensions

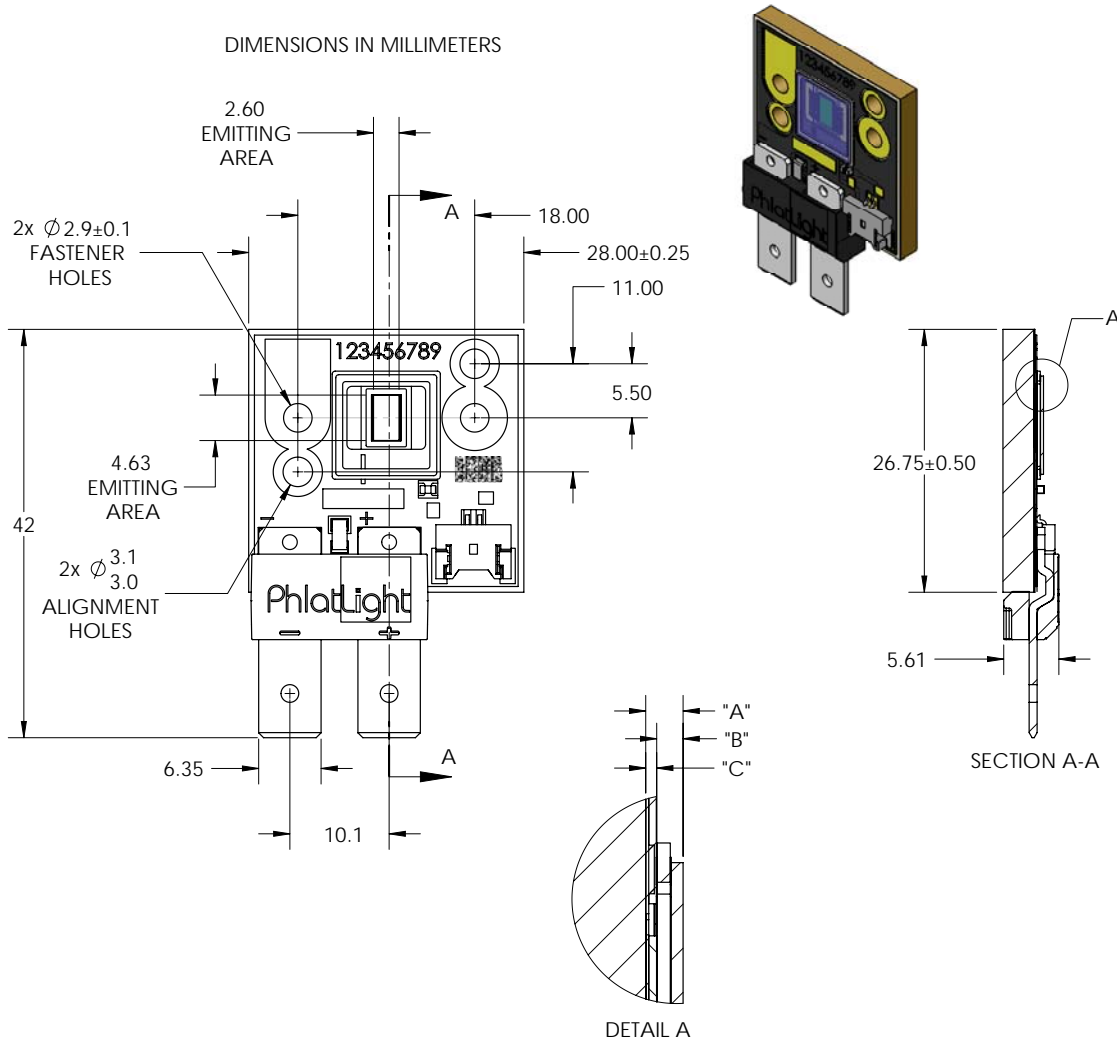

DIMENSION NAME	DESCRIPTION	NOMINAL DIMENSION	TOLERANCE
"A"	TOP OF METAL SUBSTRATE TO TOP OF GLASS	0.95	±0.12
"B"	EMITTING AREA TO TOP OF GLASS	0.67	±0.16
"C"	TOP OF METAL SUBSTRATE TO EMITTING AREA	0.28	±0.05

For detailed drawing of package, please refer to Luminus drawing #DWG-001124.

Recommended connector for Anode and Cathode: Panduit Disco Lok™ Series P/N: DNG14-250FL-C
 Thermistor Connector: MOLEX P/N 53780-0270. Recommended Female: MOLEX P/N 51146-0200 or equivalent

Ordering Information

Ordering Part Number ^{1,2,3}	Color	Description
CBT-120-R-C11-HH100	Red	Red PhlatLight CBT-120 consisting of a 12 mm ² LED, thermistor, and connector, mounted on a copper-core PCB.
CBT-120-G-C11-JH200	Green	Green PhlatLight CBT-120 consisting of a 12 mm ² LED, thermistor, and connector, mounted on a copper-core PCB.
CBT-120-B-C11-KF300	Blue	Blue PhlatLight CBT-120 consisting of a 12 mm ² LED, thermistor, and connector, mounted on a copper-core PCB.

*Note 1: HG100 - denotes a bin kit comprising of all red flux and wavelength bins as specified on page 3
 JG200 - denotes a bin kit comprising of all green flux and wavelength bins as specified on page 3
 KF300 - denotes a bin kit comprising of all blue flux and wavelength bins as specified on page 3.
 See PhlatLight Binning and Labeling document for more information.*

Note 2: For info on ordering specific bins or bin ranges, contact your local Luminus sales representative.

Note 3: Standard packaging increment (SPI) is 10.

www.luminus.com

The products, their specifications and other information appearing in this document are subject to change by Luminus Devices without notice. Luminus Devices assumes no liability for errors that may appear in this document, and no liability otherwise arising from the application or use of the product or information contained herein. None of the information provided herein should be considered to be a representation of the fitness or suitability of the product for any particular application or as any other form of warranty. Luminus Devices' product warranties are limited to only such warranties as accompany a purchase contract or purchase order for such products. Nothing herein is to be construed as constituting an additional warranty. No information contained in this publication may be considered as a waiver by Luminus Devices of any intellectual property rights that Luminus Devices may have in such information. PhlatLight[®] is a registered trademark of Luminus Devices, Inc., all rights reserved.

This product is protected by U.S. Patents 6,831,302; 7,074,631; 7,083,993; 7,084,434; 7,098,589; 7,105,861; 7,138,666; 7,166,870; 7,166,871; 7,170,100; 7,196,354; 7,211,831; 7,262,550; 7,274,043; 7,301,271; 7,341,880; 7,344,903; 7,345,416; 7,348,603; 7,388,233; 7,391,059; Patents Pending in the U.S. and other countries.