

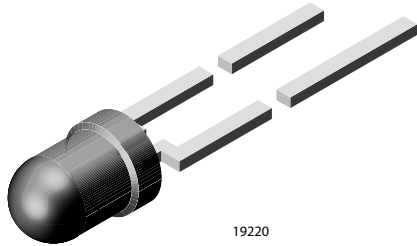

## High Efficiency LED, Ø 3 mm Tinted Undiffused Package



### FEATURES

- Choice of five bright colors
- Standard T-1 package
- Small mechanical tolerances
- Suitable for DC and high peak current
- Wide viewing angle
- Luminous intensity categorized
- Yellow and green color categorized
- Compliant to RoHS Directive 2002/95/EC and in accordance to WEEE 2002/96/E



### DESCRIPTION

The TLH.42.. series was developed for standard applications like general indicating and lighting purposes.

It is housed in a 3 mm tinted clear plastic package. The wide viewing angle of these devices provides a high on-off contrast.

Several selection types with different luminous intensities are offered. All LEDs are categorized in luminous intensity groups. The green and yellow LEDs are categorized additionally in wavelength groups.

That allows users to assemble LEDs with uniform appearance.

### APPLICATIONS

- Status lights
- Off/On indicator
- Background illumination
- Readout lights
- Maintenance lights
- Legend light

### PRODUCT GROUP AND PACKAGE DATA

- Product group: LED
- Package: 3 mm
- Product series: standard
- Angle of half intensity:  $\pm 22^\circ$

PARTS TABLE		
PART	COLOR, LUMINOUS INTENSITY	TECHNOLOGY
TLHR4200	Red, $I_V > 4$ mcd	GaAsP on GaP
TLHR4201	Red, $I_V > 6.3$ mcd	GaAsP on GaP
TLHR4201-AS12Z	Red, $I_V > 6.3$ mcd	GaAsP on GaP
TLHR4205	Red, $I_V > 10$ mcd	GaAsP on GaP
TLHR4205-AS12	Red, $I_V > 10$ mcd	GaAsP on GaP
TLHR4205-AS12Z	Red, $I_V > 10$ mcd	GaAsP on GaP
TLHO4200	Soft orange, $I_V > 4$ mcd	GaAsP on GaP
TLHO4200-AS12Z	Soft orange, $I_V > 4$ mcd	GaAsP on GaP
TLHO4201	Soft orange, $I_V > 10$ mcd	GaAsP on GaP

\*\* Please see document "Vishay Material Category Policy": [www.vishay.com/doc?99902](http://www.vishay.com/doc?99902)

PARTS TABLE		
PART	COLOR, LUMINOUS INTENSITY	TECHNOLOGY
TLHY4200	Yellow, $I_V > 4$ mcd	GaAsP on GaP
TLHY4200-AS12Z	Yellow, $I_V > 4$ mcd	GaAsP on GaP
TLHY4201	Yellow, $I_V > 6.3$ mcd	GaAsP on GaP
TLHY4201-AS21	Yellow, $I_V > 6.3$ mcd	GaAsP on GaP
TLHY4201-MS12Z	Yellow, $I_V > 6.3$ mcd	GaAsP on GaP
TLHY4205	Yellow, $I_V > 10$ mcd	GaAsP on GaP
TLHY4205-BT12Z	Yellow, $I_V > 10$ mcd	GaAsP on GaP
TLHY4205-LS21	Yellow, $I_V > 10$ mcd	GaAsP on GaP
TLHY4205-LS21Z	Yellow, $I_V > 10$ mcd	GaAsP on GaP
TLHY4205-MS12	Yellow, $I_V > 10$ mcd	GaAsP on GaP
TLHG4200	Green, $I_V > 6.3$ mcd	GaP on GaP
TLHG4200-AS12	Green, $I_V > 6.3$ mcd	GaP on GaP
TLHG4200-AS12Z	Green, $I_V > 6.3$ mcd	GaP on GaP
TLHG4200-AS21	Green, $I_V > 6.3$ mcd	GaP on GaP
TLHG4200-BT12Z	Green, $I_V > 6.3$ mcd	GaP on GaP
TLHG4201	Green, $I_V > 10$ mcd	GaP on GaP
TLHG4201-BT12Z	Green, $I_V > 10$ mcd	GaP on GaP
TLHG4205	Green, $I_V > 16$ mcd	GaP on GaP
TLHG4205-AS12Z	Green, $I_V > 16$ mcd	GaP on GaP
TLHG4205-AS21	Green, $I_V > 16$ mcd	GaP on GaP
TLHG4205-BT12Z	Green, $I_V > 16$ mcd	GaP on GaP
TLHG4205-LS21	Green, $I_V > 16$ mcd	GaP on GaP
TLHG4205-LS21Z	Green, $I_V > 16$ mcd	GaP on GaP
TLHG4205-MS21Z	Green, $I_V > 16$ mcd	GaP on GaP

ABSOLUTE MAXIMUM RATINGS ( $T_{amb} = 25$ °C unless otherwise specified) TLHG420., TLHO420., TLHR420., TLHY420.				
PARAMETER	TEST CONDITION	SYMBOL	VALUE	UNIT
Reverse voltage <sup>1)</sup>		$V_R$	6	V
DC forward current		$I_F$	30	mA
Surge forward current	$t_p \leq 10$ $\mu$ s	$I_{FSM}$	1	A
Power dissipation		$P_V$	100	mW
Junction temperature		$T_j$	100	°C
Operating temperature range		$T_{amb}$	- 40 to + 100	°C
Storage temperature range		$T_{stg}$	- 55 to + 100	°C
Soldering temperature	$t \leq 5$ s, 2 mm from body	$T_{sd}$	260	°C
Thermal resistance junction/ ambient		$R_{thJA}$	400	K/W

Note:

<sup>1)</sup> Driving the LED in reverse direction is suitable for a short term application



<b>OPTICAL AND ELECTRICAL CHARACTERISTICS</b> ( $T_{amb} = 25\text{ }^{\circ}\text{C}$ unless otherwise specified) <b>TLHR420., RED</b>							
PARAMETER	TEST CONDITION	PART	SYMBOL	MIN.	TYP.	MAX.	UNIT
Luminous intensity	$I_F = 10\text{ mA}$	TLHR4200	$I_V$	4	8		mcd
		TLHR4201	$I_V$	6.3	10		mcd
		TLHR4205	$I_V$	10	15		mcd
Dominant wavelength	$I_F = 10\text{ mA}$		$\lambda_d$	612		625	nm
Peak wavelength	$I_F = 10\text{ mA}$		$\lambda_p$		635		nm
Angle of half intensity	$I_F = 10\text{ mA}$		$\phi$		$\pm 22$		deg
Forward voltage	$I_F = 20\text{ mA}$		$V_F$		2	3	V
Reverse current	$V_R = 6\text{ V}$		$I_R$			10	$\mu\text{A}$
Junction capacitance	$V_R = 0, f = 1\text{ MHz}$		$C_j$		50		pF

<b>OPTICAL AND ELECTRICAL CHARACTERISTICS</b> ( $T_{amb} = 25\text{ }^{\circ}\text{C}$ unless otherwise specified) <b>TLHO420., SOFT ORANGE</b>							
PARAMETER	TEST CONDITION	PART	SYMBOL	MIN.	TYP.	MAX.	UNIT
Luminous intensity	$I_F = 10\text{ mA}$	TLHO4200	$I_V$	4	10		mcd
		TLHO4201	$I_V$	10	18		mcd
Dominant wavelength	$I_F = 10\text{ mA}$		$\lambda_d$	598		611	nm
Peak wavelength	$I_F = 10\text{ mA}$		$\lambda_p$		605		nm
Angle of half intensity	$I_F = 10\text{ mA}$		$\phi$		$\pm 22$		deg
Forward voltage	$I_F = 20\text{ mA}$		$V_F$		2.4	3	V
Reverse current	$V_R = 6\text{ V}$		$I_R$			10	$\mu\text{A}$
Junction capacitance	$V_R = 0, f = 1\text{ MHz}$		$C_j$		50		pF

<b>OPTICAL AND ELECTRICAL CHARACTERISTICS</b> ( $T_{amb} = 25\text{ }^{\circ}\text{C}$ unless otherwise specified) <b>TLHY420., YELLOW</b>							
PARAMETER	TEST CONDITION	PART	SYMBOL	MIN.	TYP.	MAX.	UNIT
Luminous intensity	$I_F = 10\text{ mA}$	TLHY4200	$I_V$	4	10		mcd
		TLHY4201	$I_V$	6.3	15		mcd
		TLHY4205	$I_V$	10	20		mcd
Dominant wavelength	$I_F = 10\text{ mA}$		$\lambda_d$	581		594	nm
Peak wavelength	$I_F = 10\text{ mA}$		$\lambda_p$		585		nm
Angle of half intensity	$I_F = 10\text{ mA}$		$\phi$		$\pm 22$		deg
Forward voltage	$I_F = 20\text{ mA}$		$V_F$		2.4	3	V
Reverse current	$V_R = 6\text{ V}$		$I_R$			10	$\mu\text{A}$
Junction capacitance	$V_R = 0, f = 1\text{ MHz}$		$C_j$		50		pF

<b>OPTICAL AND ELECTRICAL CHARACTERISTICS</b> ( $T_{amb} = 25\text{ }^{\circ}\text{C}$ unless otherwise specified) <b>TLHG420., GREEN</b>							
PARAMETER	TEST CONDITION	PART	SYMBOL	MIN.	TYP.	MAX.	UNIT
Luminous intensity	$I_F = 10\text{ mA}$	TLHG4200	$I_V$	6.3	10		mcd
		TLHG4201	$I_V$	10	15		mcd
		TLHG4205	$I_V$	16	20		mcd
Dominant wavelength	$I_F = 10\text{ mA}$		$\lambda_d$	562		575	nm
Peak wavelength	$I_F = 10\text{ mA}$		$\lambda_p$		565		nm
Angle of half intensity	$I_F = 10\text{ mA}$		$\phi$		$\pm 22$		deg
Forward voltage	$I_F = 20\text{ mA}$		$V_F$		2.4	3	V
Reverse current	$V_R = 6\text{ V}$		$I_R$			10	$\mu\text{A}$
Junction capacitance	$V_R = 0, f = 1\text{ MHz}$		$C_j$		50		pF

LUMINOUS INTENSITY CLASSIFICATION		
GROUP STANDARD	LUMINOUS INTENSITY (MCD)	
	MIN.	MAX.
N	2.5	5
P	4	8
Q	6.3	12.5
R	10	20
S	16	32
T	25	50
U	40	80
V	63	125
W	100	200
X	130	260
Y	180	360
Z	240	480
AA	320	640
BB	430	860
CC	575	1150
DD	750	1500

Note:

Luminous intensity is tested at a current pulse duration of 25 ms. The above type numbers represent the order groups which include only a few brightness groups. Only one group will be shipped on each bag (there will be no mixing of two groups in each bag).

In order to ensure availability, single brightness groups will not be orderable. In a similar manner for colors where wavelength groups are measured and binned, single wavelength groups will be shipped on any one bag. In order to ensure availability, single wavelength groups will not be orderable.

COLOR CLASSIFICATION						
GROUP	DOM. WAVELENGTH (nm)					
	SOFT ORANGE		YELLOW		GREEN	
	MIN.	MAX.	MIN.	MAX.	MIN.	MAX.
0						
1	598	601	581	584		
2	600	603	583	586		
3	602	605	585	588	562	565
4	604	607	587	590	564	567
5	606	609	589	592	566	569
6	608	611	591	594	568	571
7					570	573
8					572	575

Note:

Wavelengths are tested at a current pulse duration of 25 ms.

**TYPICAL CHARACTERISTICS** ( $T_{amb} = 25\text{ }^{\circ}\text{C}$ , unless otherwise specified)

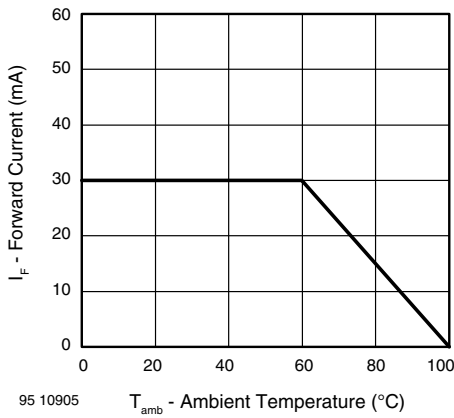

Figure 1. Forward Current vs. Ambient Temperature

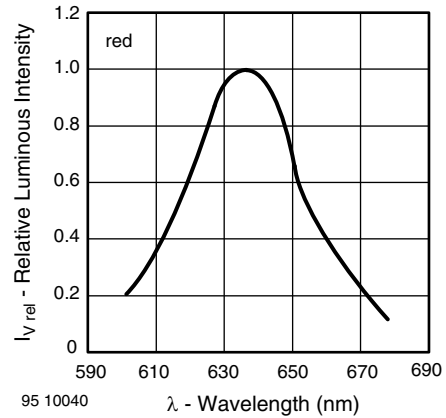

Figure 4. Relative Intensity vs. Wavelength

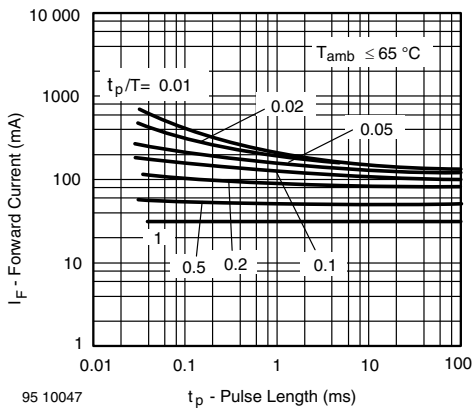

Figure 2. Forward Current vs. Pulse Length

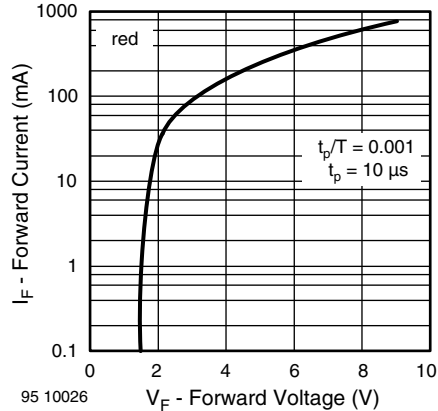

Figure 5. Forward Current vs. Forward Voltage

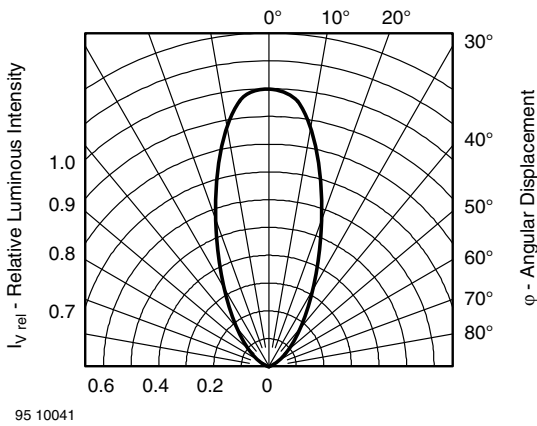

Figure 3. Rel. Luminous Intensity vs. Angular Displacement

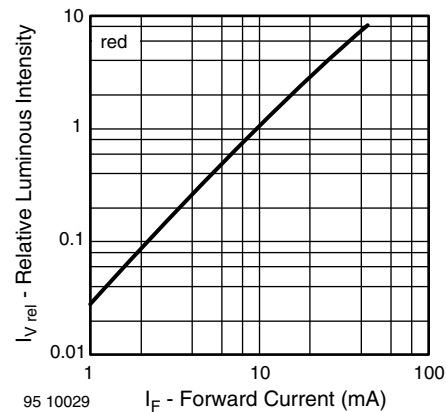

Figure 6. Relative Luminous Intensity vs. Forward Current

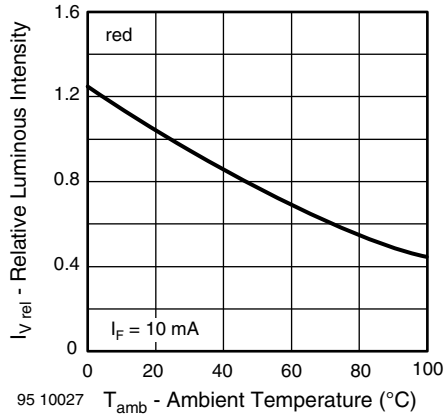

Figure 7. Rel. Luminous Intensity vs. Ambient Temperature

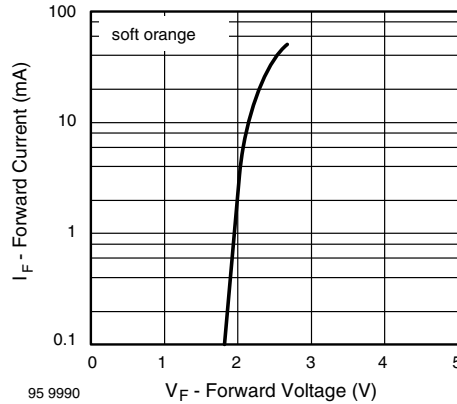

Figure 10. Forward Current vs. Forward Voltage

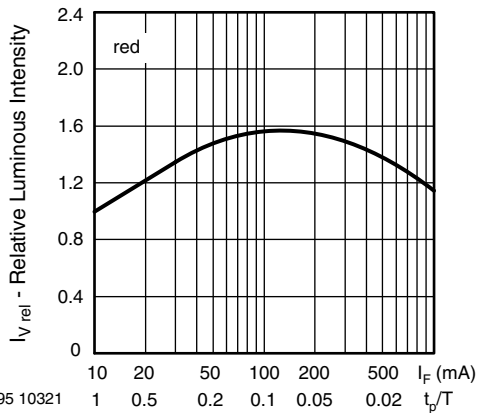

Figure 8. Rel. Lumin. Intensity vs. Forw. Current/Duty Cycle

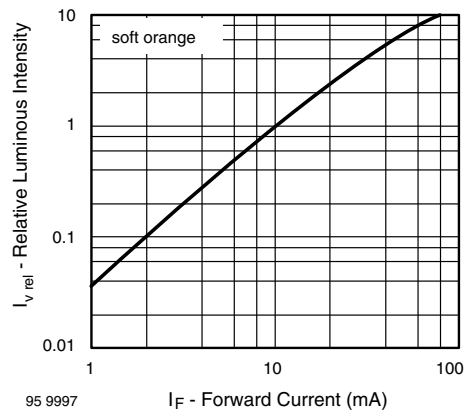

Figure 11. Relative Luminous Intensity vs. Forward Current

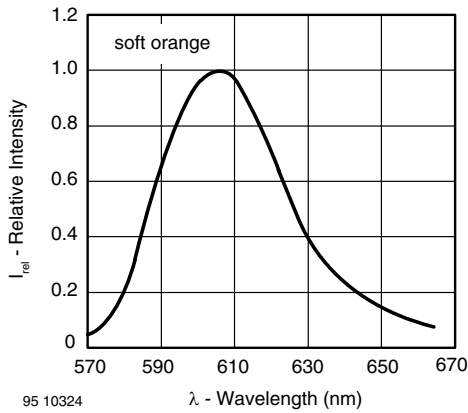

Figure 9. Relative Intensity vs. Wavelength

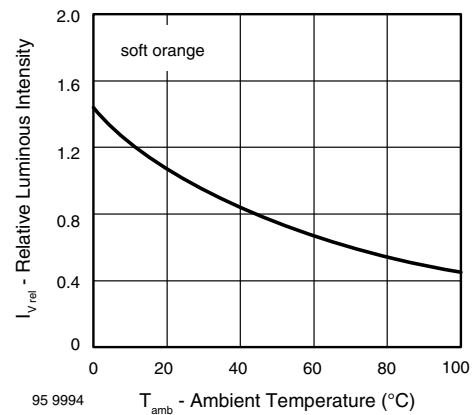

Figure 12. Rel. Luminous Intensity vs. Ambient Temperature

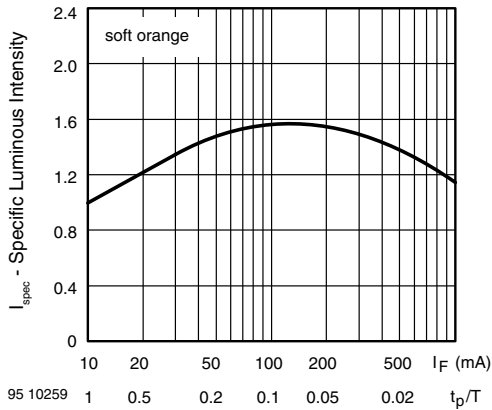

Figure 13. Rel. Lumin. Intensity vs. Forw. Current/Duty Cycle

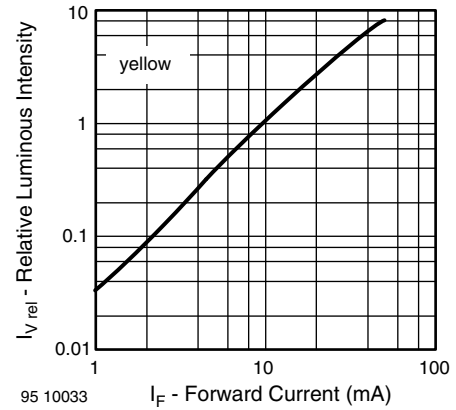

Figure 16. Relative Luminous Intensity vs. Forward Current

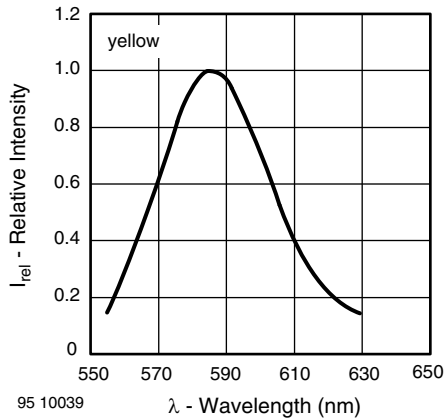

Figure 14. Relative Intensity vs. Wavelength

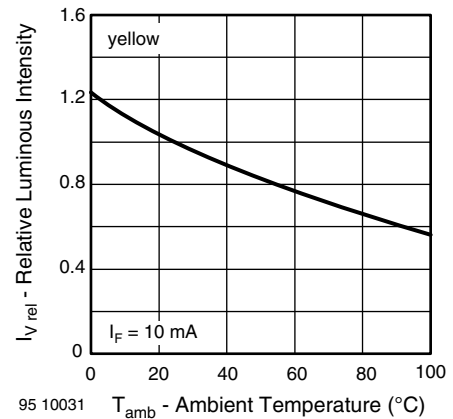

Figure 17. Rel. Luminous Intensity vs. Ambient Temperature

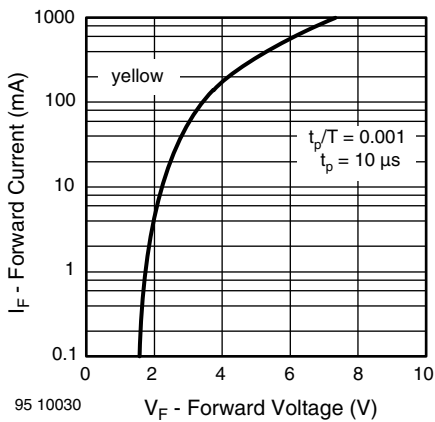

Figure 15. Forward Current vs. Forward Voltage

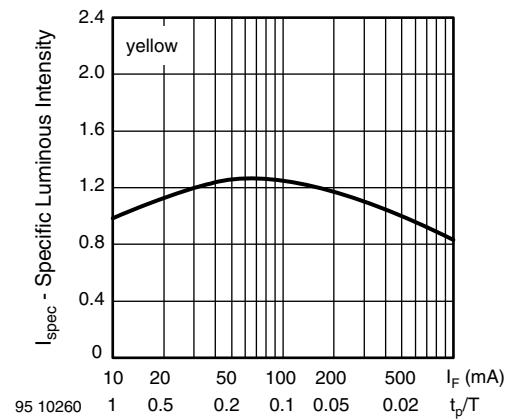

Figure 18. Rel. Lumin. Intensity vs. Forw. Current/Duty Cycle

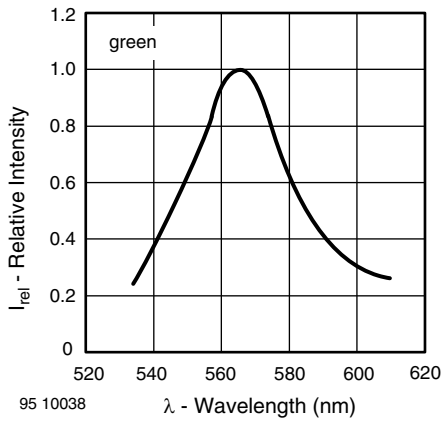

Figure 19. Relative Intensity vs. Wavelength

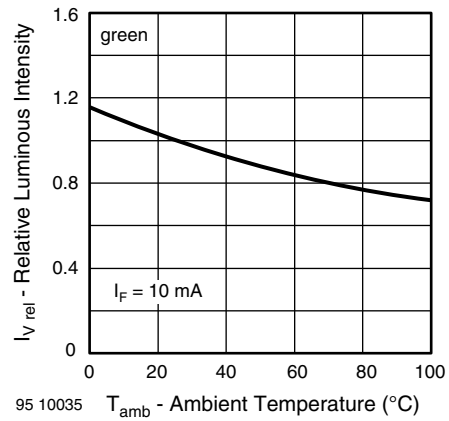

Figure 22. Rel. Luminous Intensity vs. Ambient Temperature

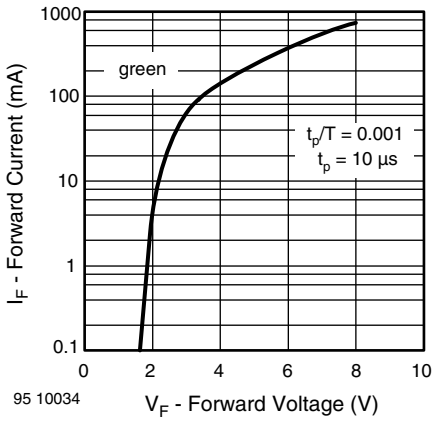

Figure 20. Forward Current vs. Forward Voltage

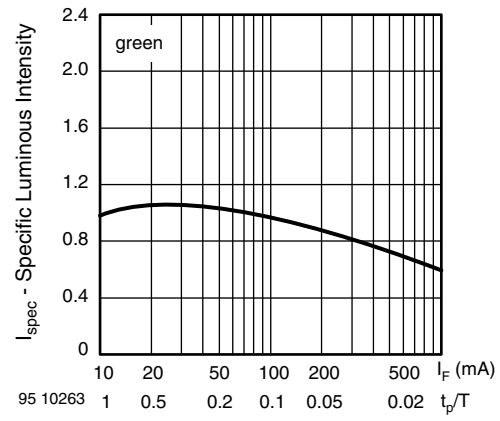

Figure 23. Specific Luminous Intensity vs. Forward Current

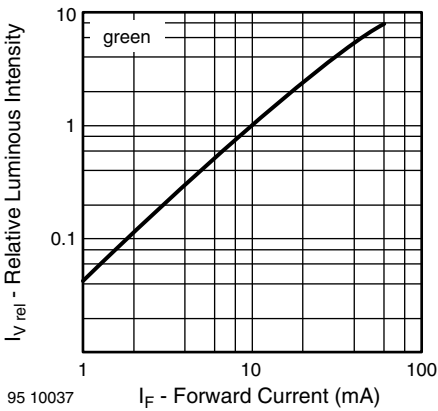
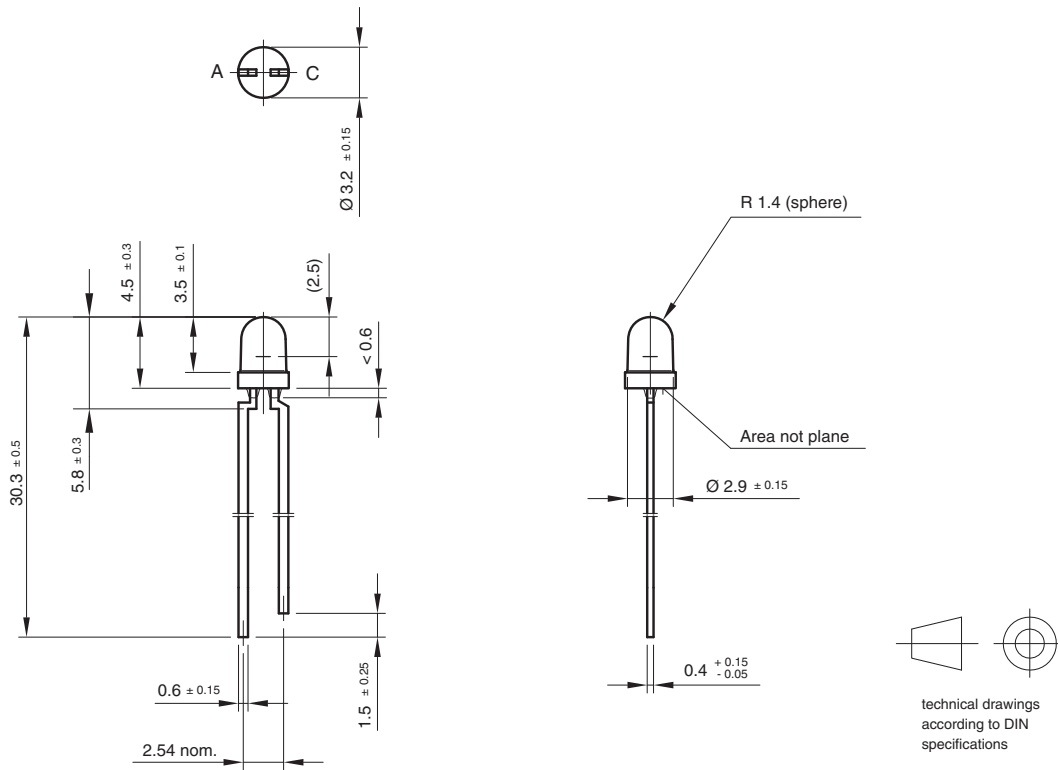

Figure 21. Relative Luminous Intensity vs. Forward Current



## PACKAGE DIMENSIONS in millimeters



Drawing-No.: 6.544-5255.01-4  
 Issue: 7; 25.09.08  
 95 10913

## REEL

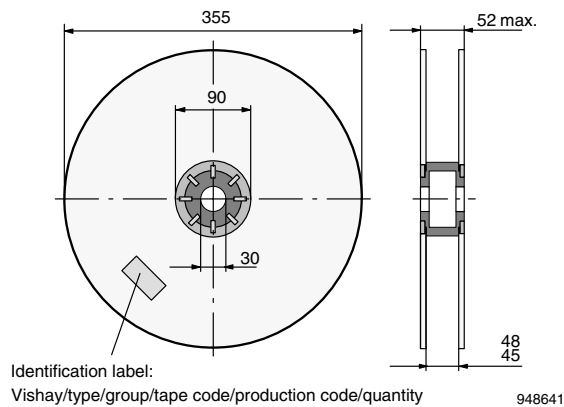

Figure 24. Reel Dimensions

AS12 = cathode leaves tape first

AS21 = anode leaves tape first

## TAPE

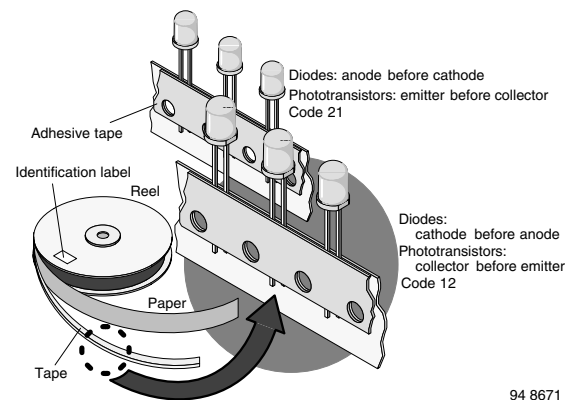

Figure 25. LED in Tape

### AMMOPACK

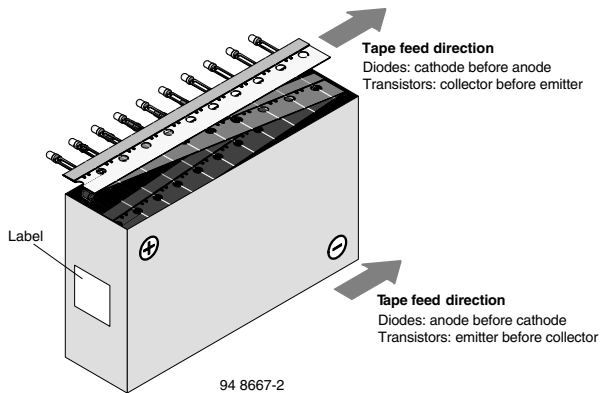
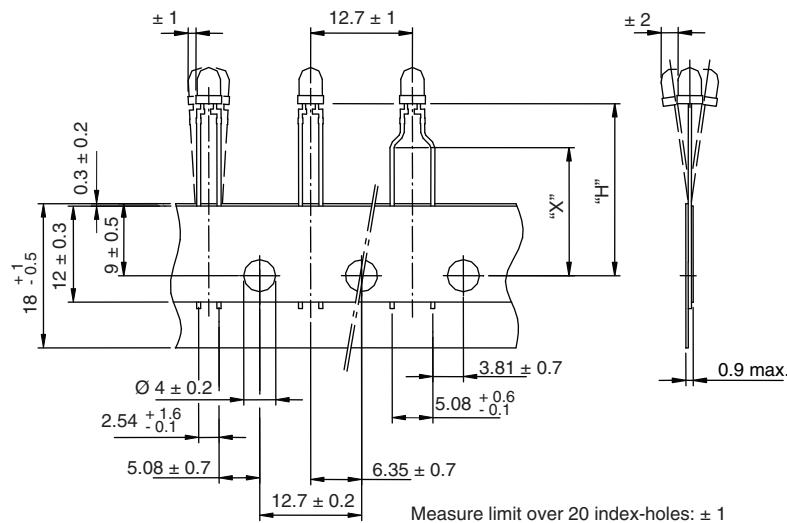

Figure 26. Tape Direction

**Note:**

The new nomenclature for ammopack is ASZ only, without suffix for the LED orientation. The carton box has to be turned to the desired position: “+” for anode first, or “-” for cathode first. AS12Z and AS21Z are still valid for already existing types, BUT NOT FOR NEW DESIGN.

### TAPE DIMENSIONS in millimeters



Quantity per:	Reel (Mat.-no. 1764)
	2000

21885

Option	Dim. “H” ± 0.5 mm	Dim. “X” ± 0.5 mm
AS	17.3	-
LS	21	-
MS	25.5	-
BT	20	16



## Disclaimer

ALL PRODUCT, PRODUCT SPECIFICATIONS AND DATA ARE SUBJECT TO CHANGE WITHOUT NOTICE TO IMPROVE RELIABILITY, FUNCTION OR DESIGN OR OTHERWISE.

Vishay Intertechnology, Inc., its affiliates, agents, and employees, and all persons acting on its or their behalf (collectively, "Vishay"), disclaim any and all liability for any errors, inaccuracies or incompleteness contained in any datasheet or in any other disclosure relating to any product.

Vishay makes no warranty, representation or guarantee regarding the suitability of the products for any particular purpose or the continuing production of any product. To the maximum extent permitted by applicable law, Vishay disclaims (i) any and all liability arising out of the application or use of any product, (ii) any and all liability, including without limitation special, consequential or incidental damages, and (iii) any and all implied warranties, including warranties of fitness for particular purpose, non-infringement and merchantability.

Statements regarding the suitability of products for certain types of applications are based on Vishay's knowledge of typical requirements that are often placed on Vishay products in generic applications. Such statements are not binding statements about the suitability of products for a particular application. It is the customer's responsibility to validate that a particular product with the properties described in the product specification is suitable for use in a particular application. Parameters provided in datasheets and/or specifications may vary in different applications and performance may vary over time. All operating parameters, including typical parameters, must be validated for each customer application by the customer's technical experts. Product specifications do not expand or otherwise modify Vishay's terms and conditions of purchase, including but not limited to the warranty expressed therein.

Except as expressly indicated in writing, Vishay products are not designed for use in medical, life-saving, or life-sustaining applications or for any other application in which the failure of the Vishay product could result in personal injury or death. Customers using or selling Vishay products not expressly indicated for use in such applications do so at their own risk and agree to fully indemnify and hold Vishay and its distributors harmless from and against any and all claims, liabilities, expenses and damages arising or resulting in connection with such use or sale, including attorneys fees, even if such claim alleges that Vishay or its distributor was negligent regarding the design or manufacture of the part. Please contact authorized Vishay personnel to obtain written terms and conditions regarding products designed for such applications.

No license, express or implied, by estoppel or otherwise, to any intellectual property rights is granted by this document or by any conduct of Vishay. Product names and markings noted herein may be trademarks of their respective owners.