

Property of Lite-On Only

### Features

- \* Super thin (0.80H mm) Chip LED.
- \* Package in 8mm tape on 7" diameter reels.
- \* Compatible with automatic placement equipment.
- \* Compatible with infrared and vapor phase reflow solder process.
- \* EIA STD package.
- \* I.C. compatible.

### Package Dimensions

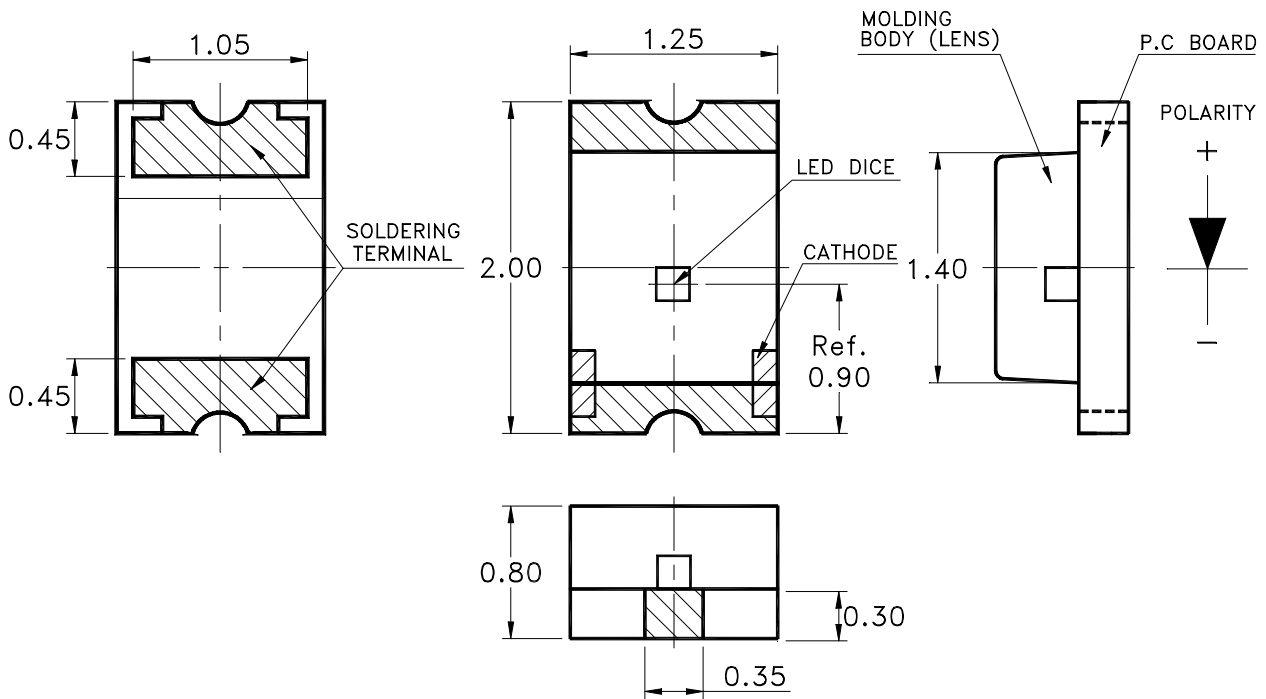

Part no.	Lens	Source Color
LTST-C171TBKT	Water Clear	GaN Blue

### Notes:

1. All dimensions are in millimeters (inches).
2. Tolerance is  $\pm 0.1\text{mm}$  (.004") unless otherwise noted.

## Property of Lite-On Only

### Absolute Maximum Ratings At Ta=25°C

Parameter	LTST-C171TBKT	Unit
Power Dissipation	120	mW
Peak Forward Current (1/10 Duty Cycle, 0.1ms Pulse Width)	100	mA
Continuous Forward Current	20	mA
Derating Linear From 25°C	0.25	mA/°C
Reverse Voltage	5	V
Electrostatic Discharge Threshold(HBM) <sup>Note A</sup>	300	V
Operating Temperature Range	-20°C to + 80°C	
Storage Temperature Range	-30°C to + 100°C	
Wave Soldering Condition	260°C For 5 Seconds	
Infrared Soldering Condition	260°C For 5 Seconds	
Vapor Phase Soldering Condition	215°C For 3 Minutes	

Note A :

HBM : Human Body Model. Seller gives no other assurances regarding the ability of to withstand ESD.

Suggest IR Reflow Condition :

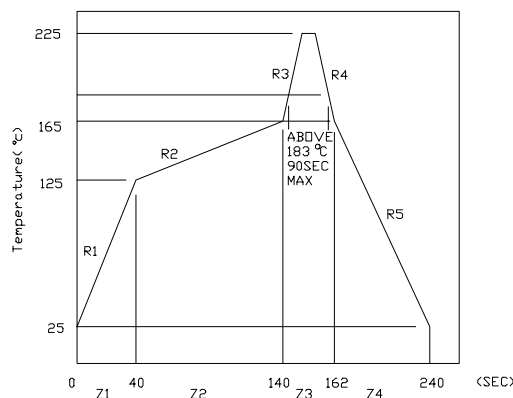

Property of Lite-On Only

Electrical Optical Characteristics At Ta=25°C

Parameter	Symbol	Part No. LTST-	Min.	Typ.	Max.	Unit	Test Condition
Luminous Intensity	IV	C171TBKT	20.0	30.0		mcd	IF = 20mA Note 1
Viewing Angle	$2\theta 1/2$	C171TBKT		130		deg	Note 2 (Fig.6)
Peak Emission Wavelength	$\lambda$ Peak	C171TBKT		468		nm	Measurement @Peak (Fig.1)
Dominant Wavelength	$\lambda$ d	BIN AC BIN AD	465 470		470 475	nm	Note 3
Spectral Line Half-Width	$\Delta \lambda$	C171TBKT		25		nm	
Forward Voltage	VF	C171TBKT		3.4	3.8	V	IF = 20mA
Reverse Current	IR	C171TBKT			100	$\mu$ A	VR = 5V

Notes: 1. Luminous intensity is measured with a light sensor and filter combination that approximates the CIE eye-response curve.

2.  $\theta 1/2$  is the off-axis angle at which the luminous intensity is half the axial luminous intensity.

3. The dominant wavelength,  $\lambda$  d is derived from the CIE chromaticity diagram and represents the single wavelength which defines the color of the device.

4. Caution in ESD:

Static Electricity and surge damages the LED. It is recommend to use a wrist band or anti-electrostatic glove when handling the LED. All devices, equipment and machinery must be properly grounded.

Property of Lite-On Only

## Typical Electrical / Optical Characteristics Curves

(25°C Ambient Temperature Unless Otherwise Noted)

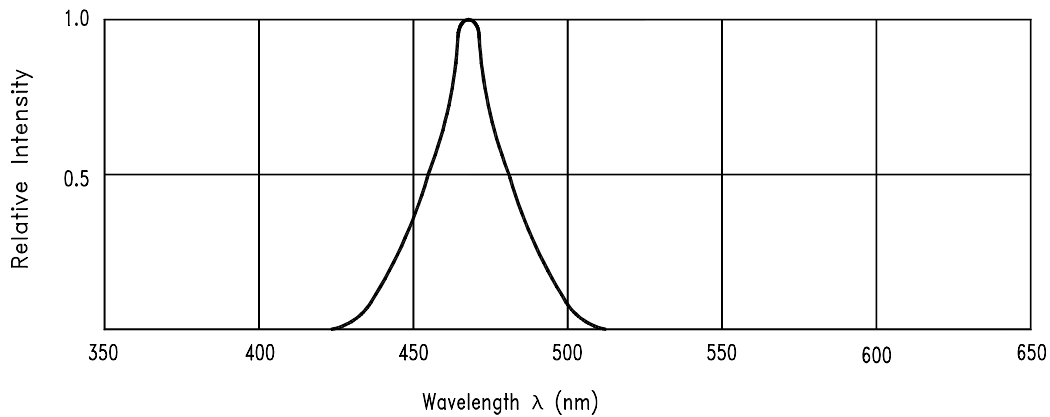

Fig.1 Relative Intensity vs. Wavelength

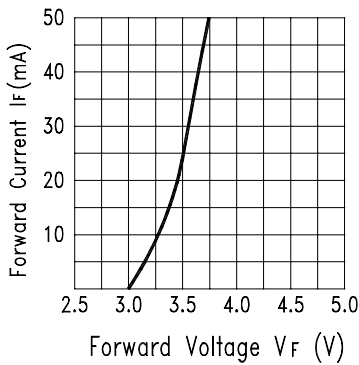

Fig.2 Forward Current vs. Forward Voltage

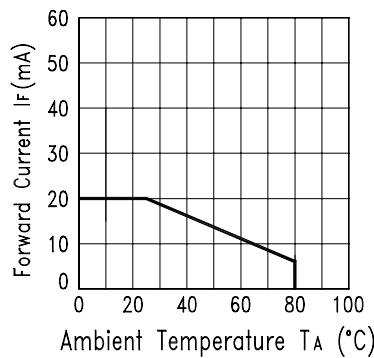

Fig.3 Forward Current Derating Curve

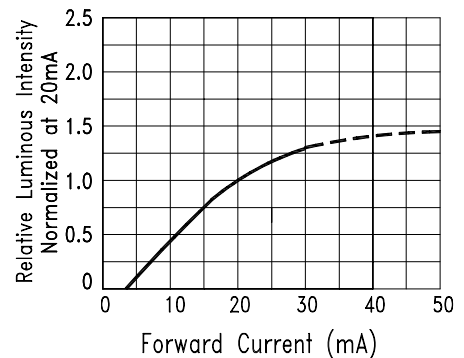

Fig.4 Relative Luminous Intensity vs. Forward Current

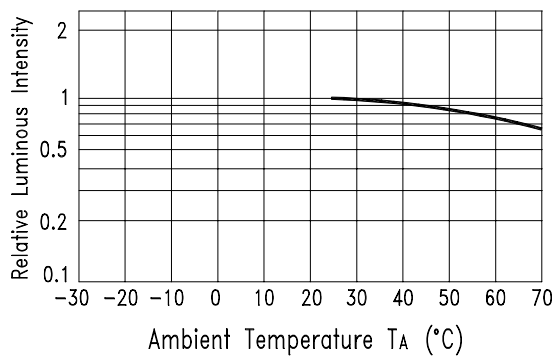

Fig.5 Luminous Intensity vs. Ambient Temperature

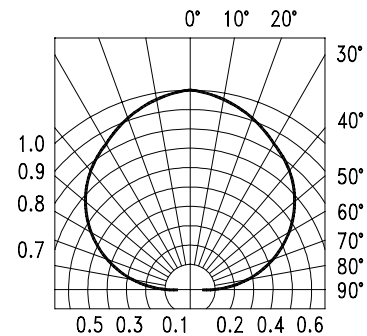

Fig.6 Spatial Distribution

Property of Lite-On Only

### Cleaning

Do not use unspecified chemical liquid to clean LED they could harm the package.  
If clean is necessary, immerse the LED in ethyl alcohol or in isopropyl alcohol at normal temperature for less one minute.

### Suggest Soldering Pad Dimensions

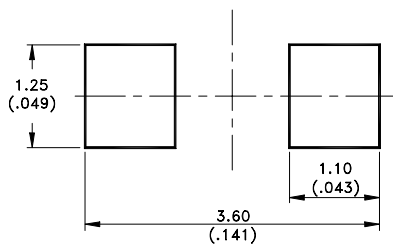

### Package Dimensions Of Tape And Reel

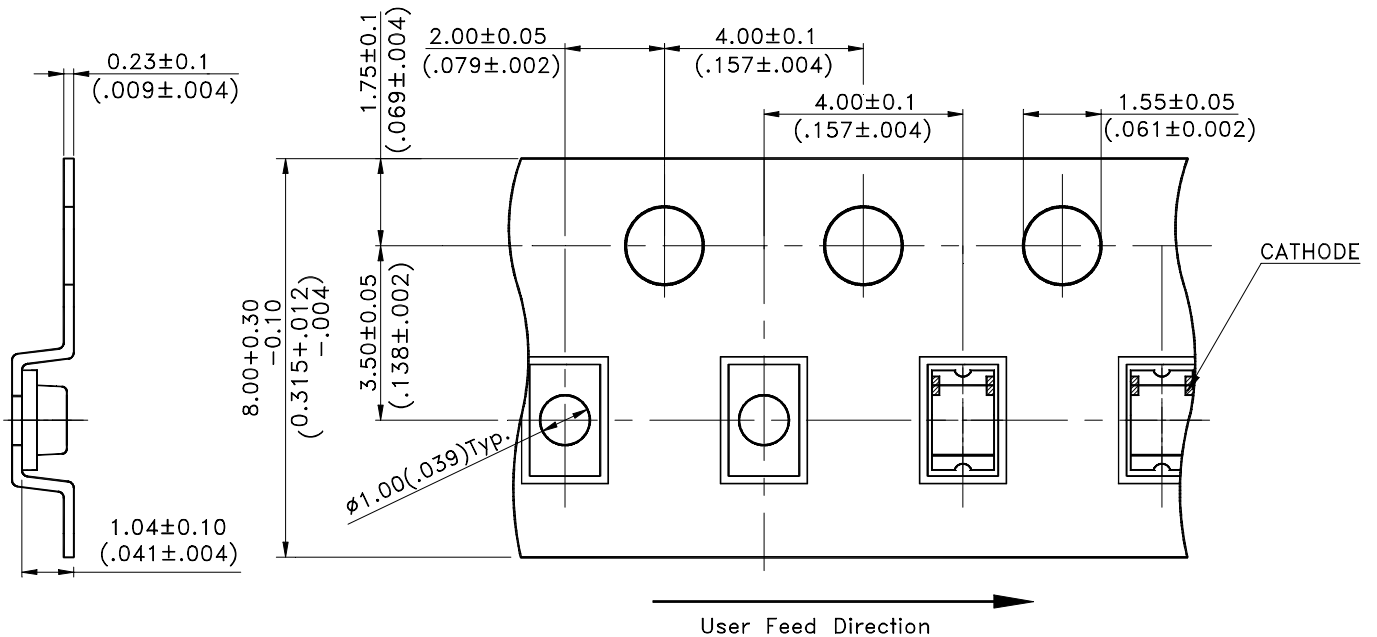

### Notes:

1. All dimensions are in millimeters (inches).

Property of Lite-On Only

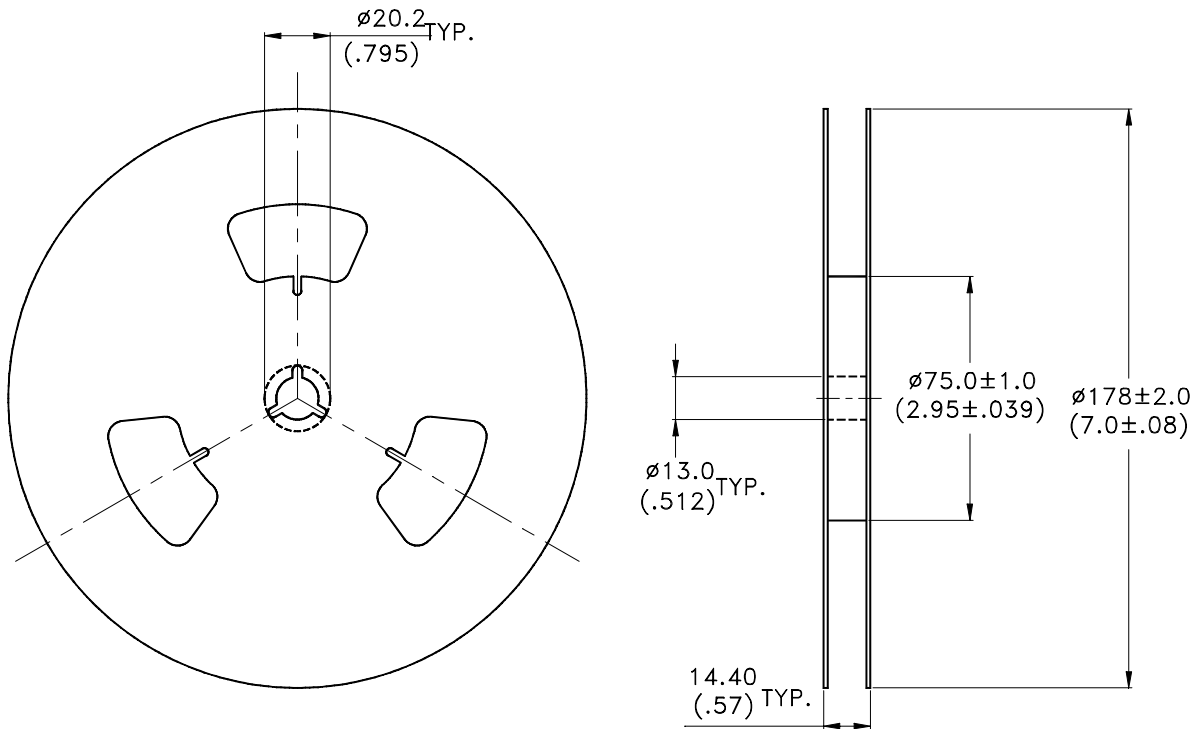

## Notes:

1. Empty component pockets sealed with top cover tape.
2. 7 inch reel-3000 pieces per reel.
3. The maximum number of consecutive missing lamps is two.
4. In accordance with ANSI/EIA 481-1-A-1994 specifications.