

Features

- Package in 8mm tape on a 7" diameter reel.
- Compatible with automatic placement equipment.
- Compatible with infrared and vapor phase reflow solder process.
- Multi-color type.
- Pb-free.
- RoHS compliant version.



Descriptions

- The SMD LED is much smaller than lead frame type components, thus enable smaller board size, higher packing density and reduced storage space and finally smaller equipment to be obtained.
- Light weight makes them ideal for miniature applications.

Applications

- Automotive.
- Portable equipment.
- General use.

Device Selection Guide

Chip			Lens Color
Type	Material	Emitted Color	
R6	AlInGaN	Brilliant Red	Water Clear
GH	InGaN	Brilliant Green	
BH	InGaN	Blue	

Package Outline Dimensions

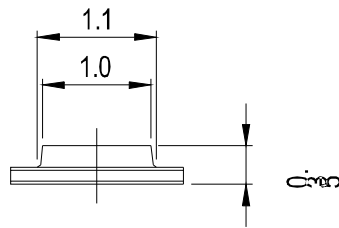
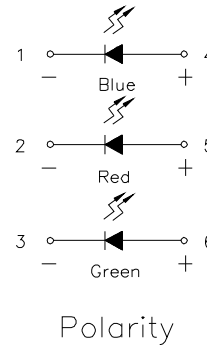
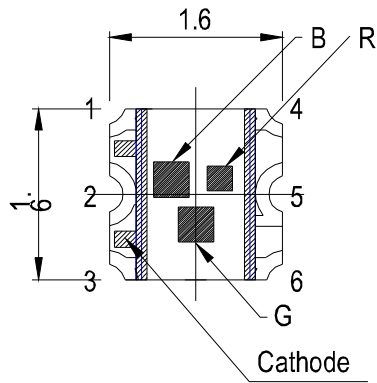

For reflow soldering (propose)

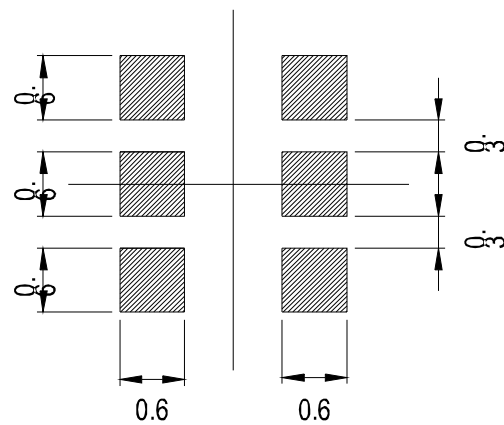
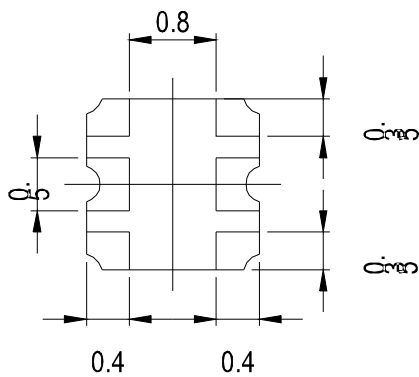

Note: The tolerances unless mentioned is ± 0.1 mm, Unit = mm

Absolute Maximum Ratings (Ta=25°C)

Parameter	Symbol	Rating	Unit
Reverse Voltage	V _R	5	V
Forward Current	I _F	R6:25 GH:25 BH:25	mA
Operating Temperature	T _{opr}	-40 ~ +85	°C
Storage Temperature	T _{stg}	-40 ~ +90	°C
Soldering Temperature	T _{sol}	260 (for 5 seconds)	°C
Electrostatic Discharge	ESD	R6:2000 GH:150 BH:150	V
Power Dissipation	P _d	R6:60 GH:110 BH:110	mW
Peak Forward Current (Duty 1/10 @1KHz)	I _{FP}	R6:60 GH:100 BH:100	mA

Specific binning requirements- please contact our home office

Electro-Optical Characteristics (Ta=25°C)

Parameter	Symbol	Min.	Typ.	Max.	Unit	Condition
Luminous Intensity	R6	72	100		mcd	If=20mA
	Iv GH	112	180	-----		
	BH	28.5	50			
Viewing Angle	2θ 1/2	-----	120	-----	deg	
Peak Wavelength	R6		632		nm	
	λ p GH	-----	518	-----		
	BH		468			
Dominant Wavelength	R6		624		nm	
	λ d GH	-----	525	-----		
	BH		470			
Spectrum Radiation Bandwidth	R6		20		nm	
	Δ λ GH	-----	35	-----		
	BH		35			
Forward Voltage	R6		2.0	2.4	V	
	Vf GH	-----	3.3	3.9		
	BH		3.3	3.9		
Reverse Current	R6			10	μ A	Vr=5V
	Ir GH	-----	-----	50		
	BH			50		

Notes:

1. Tolerance of Luminous Intensity ± 10%
2. Tolerance of Dominant Wavelength ± 1nm
3. Tolerance of Forward Voltage ± 0.1V

Typical Electro-Optical Characteristics Curves

R6

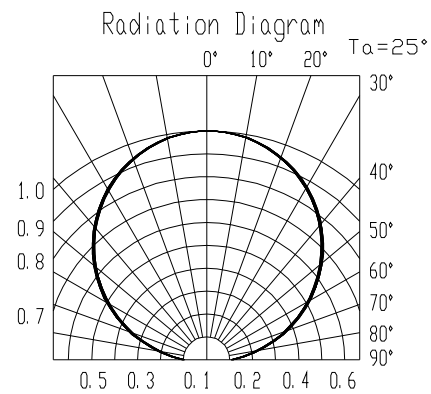
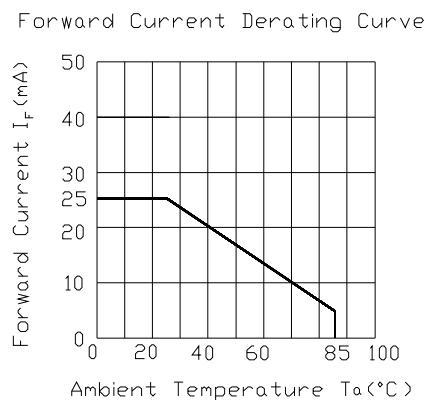
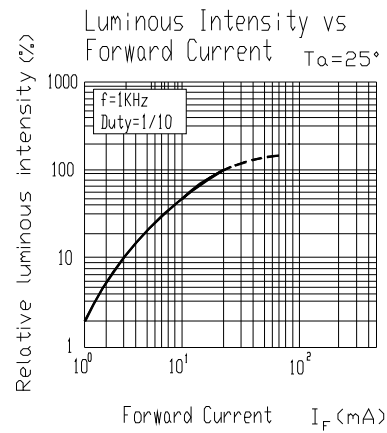
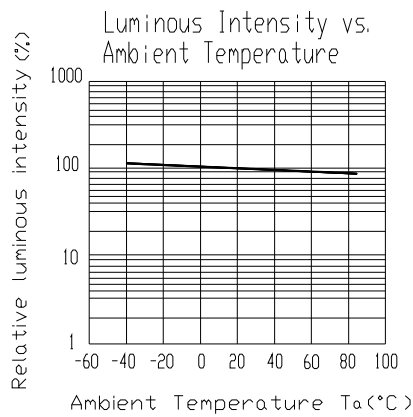
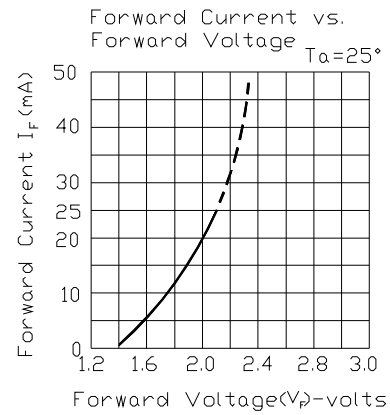
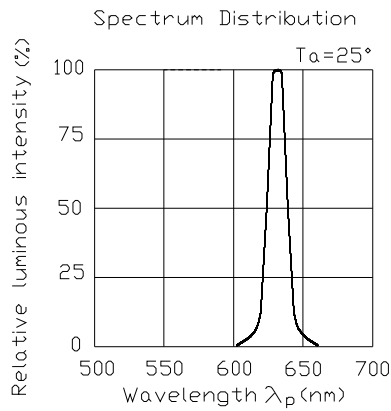

Typical Electro-Optical Characteristics Curves

GH

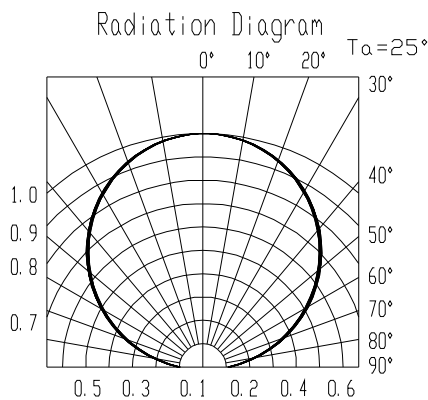
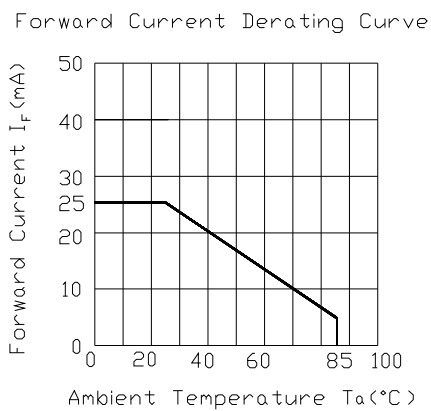
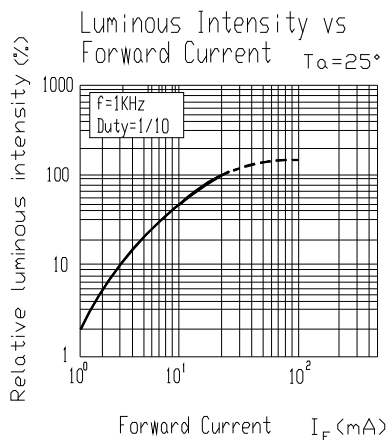
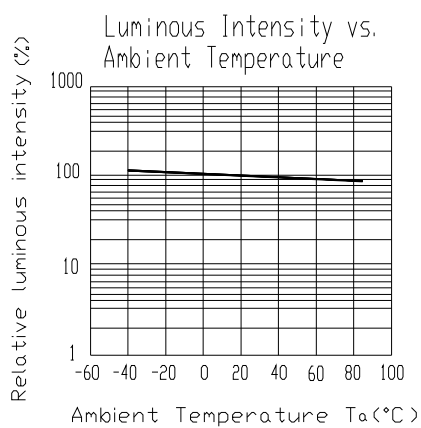
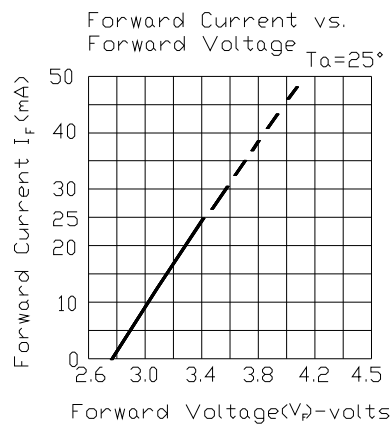
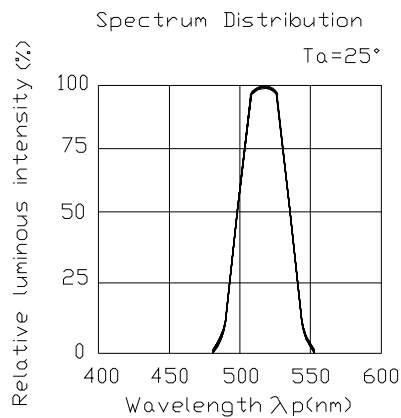

Typical Electro-Optical Characteristics Curves

BH

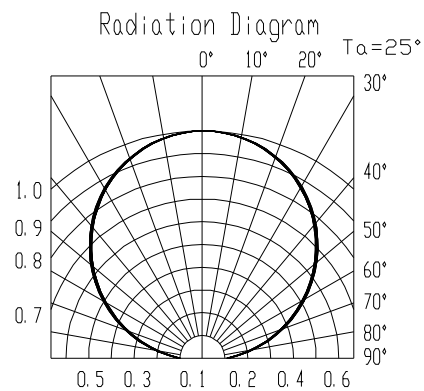
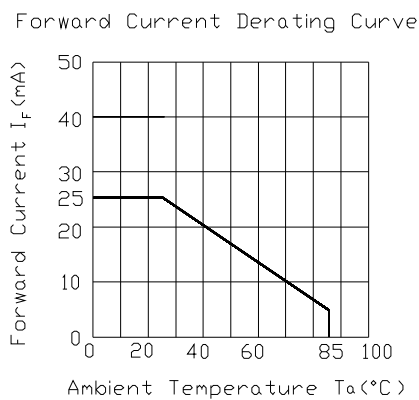
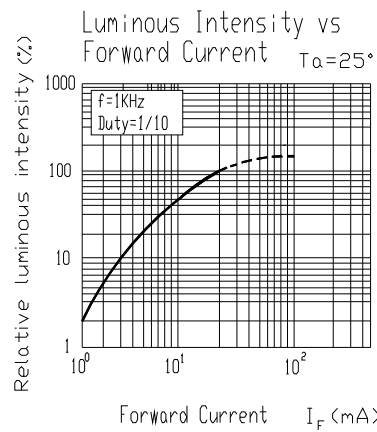
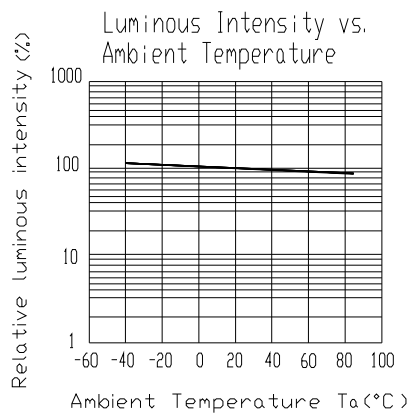
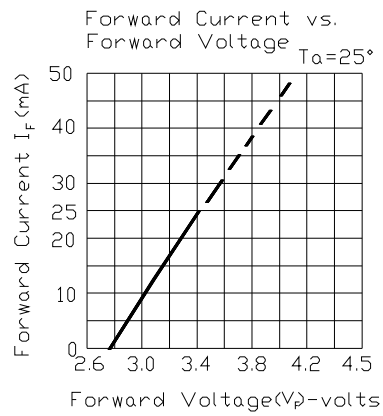
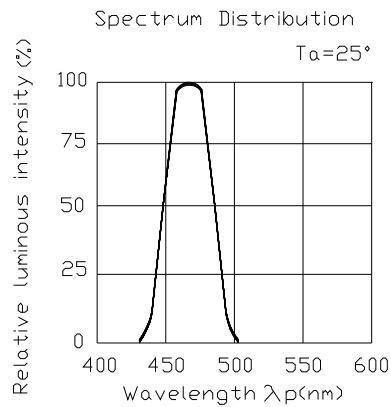

Reel Dimensions

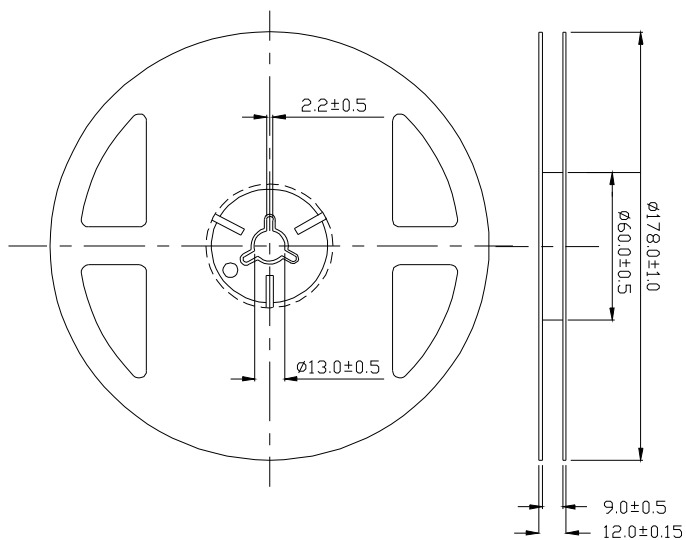

Note: The tolerances unless mentioned is ± 0.1 mm ,Unit = mm

Carrier Tape Dimensions: Loaded quantity 2000 PCS per reel

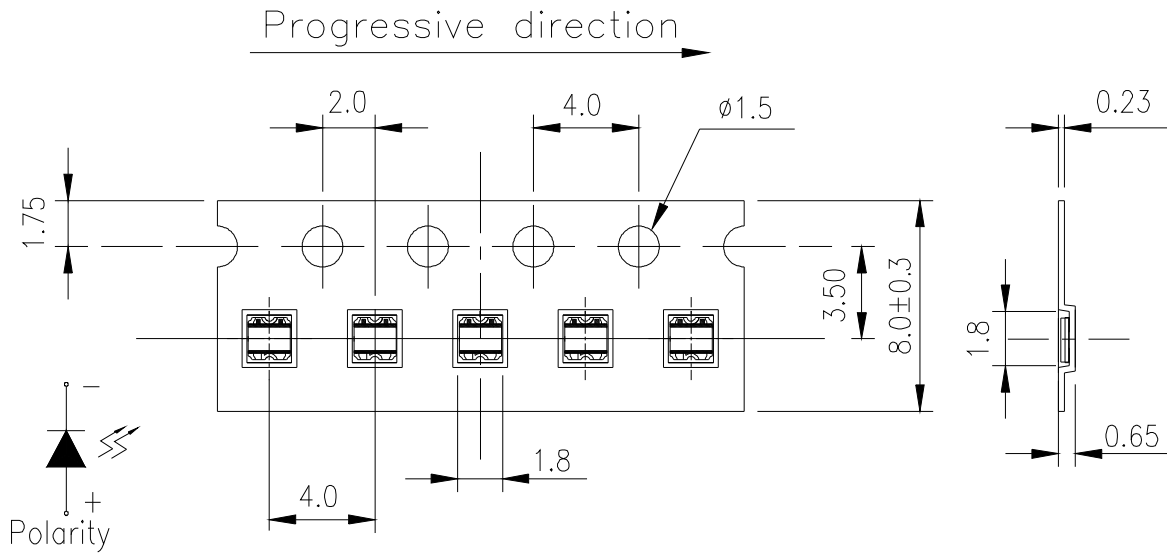

Note: The tolerances unless mentioned is $\pm 0.1\text{mm}$,Unit = mm

Moisture Resistant Packaging

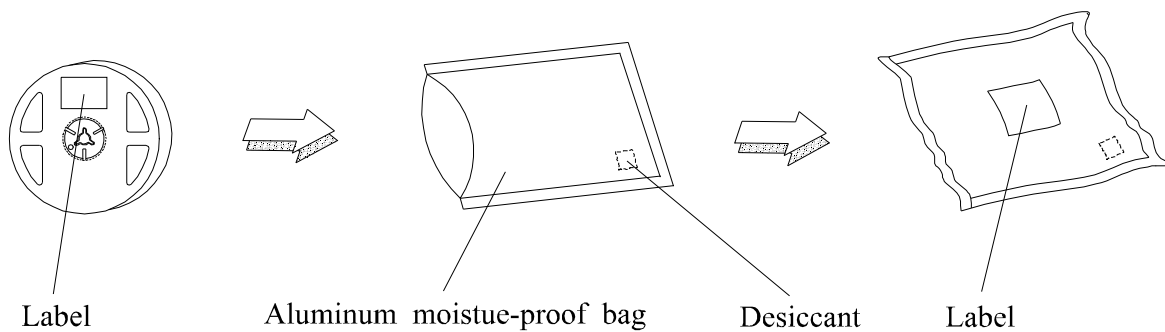

Reliability Test Items And Conditions

The reliability of products shall be satisfied with items listed below.

Confidence level : 90%

LTPD : 10%

No.	Items	Test Condition	Test Hours/Cycles	Sample Size	Ac/Re
1	Reflow Soldering	Temp. : 260°C ±5°C 5sec.	6 Min.	22 PCS.	0/1
2	Temperature Cycle	H : +100°C 15min ∫ 5 min L : -40°C 15min	300 Cycles	22 PCS.	0/1
3	Thermal Shock	H : +100°C 5min ∫ 10 sec L : -10°C 5min	300 Cycles	22 PCS.	0/1
4	High Temperature Storage	Temp. : 100°C	1000 Hrs.	22 PCS.	0/1
5	Low Temperature Storage	Temp. : -40°C	1000 Hrs.	22 PCS.	0/1
6	DC Operating Life	I _F = 20 mA	1000 Hrs.	22 PCS.	0/1
7	High Temperature / High Humidity	85°C / 85% RH	1000 Hrs.	22 PCS.	0/1

Precautions For Use

1. Customer must apply resistors for protection , otherwise slight a voltage shift will cause a big current change.
2. Storage
 - 2.1 Do not open moisture proof bag before the products are ready to use.
 - 2.2 Before opening the package, the LEDs should be kept at 30°C or less and 90%RH or less.
 - 2.3 The LEDs should be used within a year.
 - 2.4 After opening the package, the LEDs should be kept at 30°C or less and 70%RH or less.
 - 2.5 The LEDs should be used within 168 hours (7 days) after opening the package.
 - 2.6 If the moisture absorbent material (silica gel) has faded away or the LEDs have exceeded the storage time, baking treatment should be performed using the following conditions.
Baking treatment : 60±5°C for 24 hours.

3. Soldering Condition

3.1 Pb-free solder temperature profile

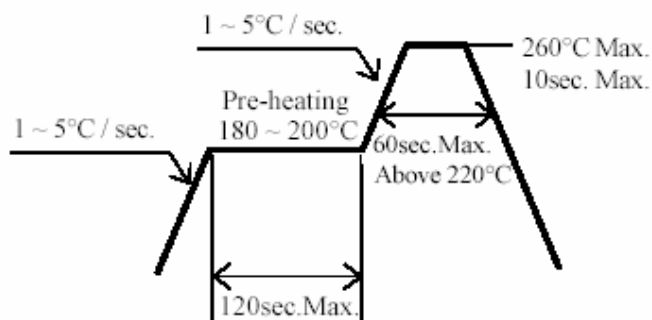

- 3.2 Reflow soldering should not be done more than two times.
- 3.3 When soldering, do not put stress on the LEDs during heating.
- 3.4 After soldering, do not warp the circuit board.

4. Soldering Iron

Each terminal is to go to the tip of soldering iron temperature less than 280°C for 3 seconds within once in less than the soldering iron capacity 25W. Leave two seconds and more intervals, and do soldering of each terminal. Be careful because the damage of the product is often started at the time of the hand solder.