

Part Number: WP59BL/GEW

GREEN

HIGH EFFICIENCY RED

### Features

- PRE-TRIMMED LEADS FOR PC BOARD MOUNTING.
- 3 LEADS WITH COMMON CATHODE LEAD.
- I.C. COMPATIBLE.
- BLACK CASE ENHANCES CONTRAST RATIO.
- WIDE VIEWING ANGLE.
- HIGH RELIABILITY - LIFE MEASURED IN YEARS.
- UL RATING : 94V-0.
- HOUSING MATERIAL: TYPE 66 NYLON.
- RoHS COMPLIANT.

### Description

The Green source color devices are made with Gallium Phosphide Green Light Emitting Diode.

The High Efficiency Red source color devices are made With Gallium Arsenide Phosphide on Gallium Phosphide Orange Light Emitting Diode.

### Package Dimensions

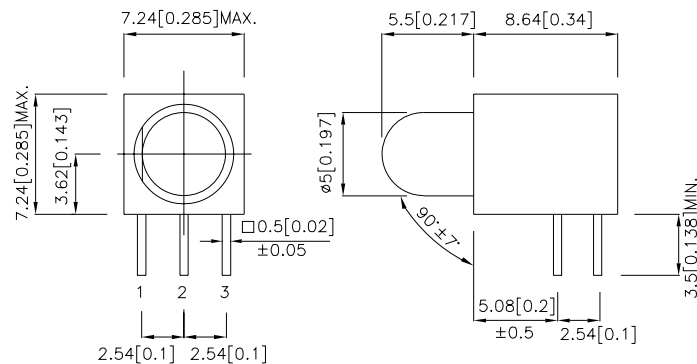

### RECOMMENDED PCB LAYOUT

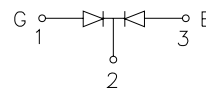
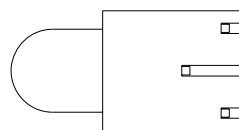
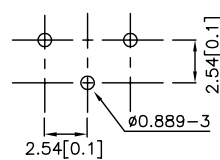

- 1 ANODE GREEN
- 2 COMMON CATHODE
- 3 ANODE RED

### Notes:

1. All dimensions are in millimeters (inches).
2. Tolerance is  $\pm 0.25$  (0.01") unless otherwise noted.
3. Lead spacing is measured where the leads emerge from the package.
4. Specifications are subject to change without notice.

## Selection Guide

Part No.	Dice	Lens Type	Iv (mcd) [2] @ 20mA		Viewing Angle [1]
			Min.	Typ.	2 $\theta$ 1/2
WP59BL/GEW	GREEN (GaP)	WHITE DIFFUSED	18	50	60°
	HIGH EFFICIENCY RED (GaAsP/GaP)		18	60	

Notes:

1.  $\theta$ 1/2 is the angle from optical centerline where the luminous intensity is 1/2 the optical centerline value.
2. Luminous intensity/ luminous flux: +/-15%.

## Electrical / Optical Characteristics at TA=25°C

Symbol	Parameter	Device	Typ.	Max.	Units	Test Conditions
$\lambda_{peak}$	Peak Wavelength	Green High Efficiency Red	565 627		nm	I <sub>F</sub> =20mA
$\lambda_D$ [1]	Dominant Wavelength	Green High Efficiency Red	568 625		nm	I <sub>F</sub> =20mA
$\Delta\lambda_{1/2}$	Spectral Line Half-width	Green High Efficiency Red	30 45		nm	I <sub>F</sub> =20mA
C	Capacitance	Green High Efficiency Red	15 15		pF	V <sub>F</sub> =0V;f=1MHz
V <sub>F</sub> [2]	Forward Voltage	Green High Efficiency Red	2.2 2.0	2.5 2.5	V	I <sub>F</sub> =20mA
I <sub>R</sub>	Reverse Current	Green High Efficiency Red		10 10	uA	V <sub>R</sub> = 5V

Notes:

1. Wavelength: +/-1nm.
2. Forward Voltage: +/-0.1V.

## Absolute Maximum Ratings at TA=25°C

Parameter	Green	High Efficiency Red	Units
Power dissipation	62.5	75	mW
DC Forward Current	25	30	mA
Peak Forward Current [1]	140	160	mA
Reverse Voltage	5		V
Operating/storage Temperature	-40°C To +85°C		
Lead Solder Temperature [2]	260°C For 3 Seconds		
Lead Solder Temperature [3]	260°C For 5 Seconds		

Notes:

1. 1/10 Duty Cycle, 0.1ms Pulse Width.
2. 2mm below package base.
3. 5mm below package base.

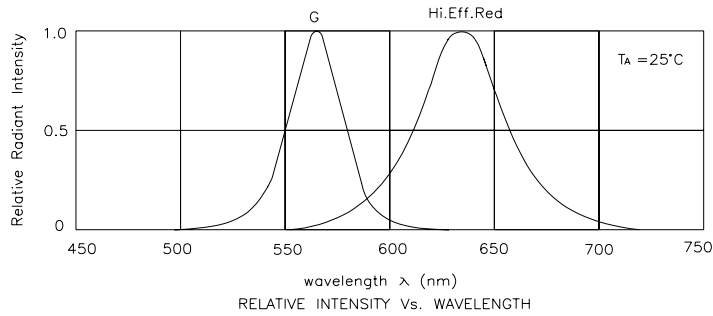

## Green /High Efficiency Red

## WP59BL/GEW

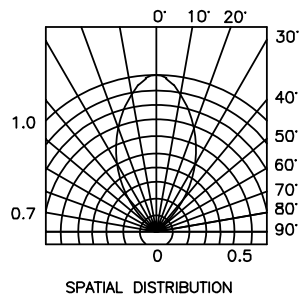
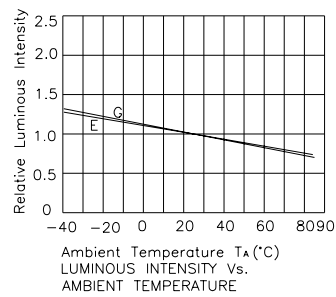
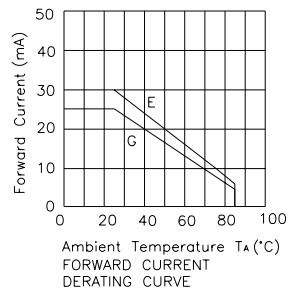
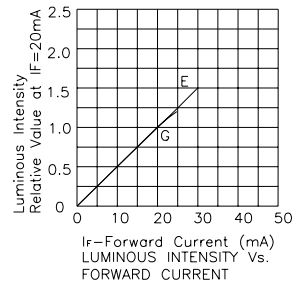
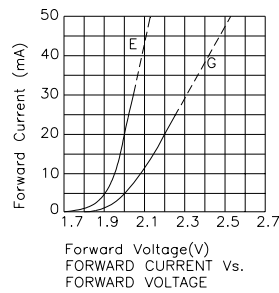

# Kingbright

## PACKING & LABEL SPECIFICATIONS

## WP59BL/GEW

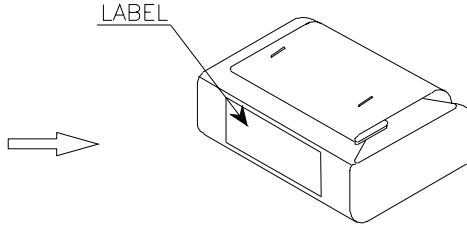
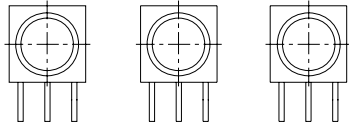

500PCS / BAG



14K / 9# BOX

OUTSIDE LABEL

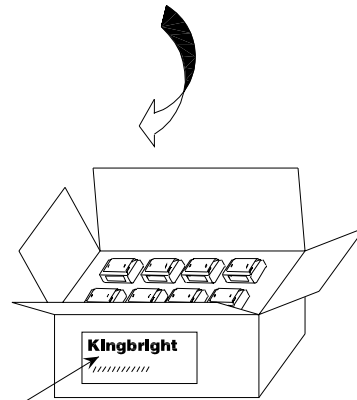

OUTSIDE LABEL

7K / 5# BOX

<b>Kingbright</b>	
Q.C.	QC xxx xx. xxxx PASSED
TYPE NO : WP59BL/XXX	
QUANTITY : 500 pcs	
S/N : XXX	CODE: XXX
LOT NO: 	
MADE IN CHINA	RoHS Compliant