





Messrs.					
Product Specification	Model:	MTF-TQ35SN741-AV	Rev. No.	Issued Date.	Page.
			G	Jun.23, 08	1 / 29

LIQUID CRYSTAL DISPLAY MODULE
MODEL: MTF-TQ35SN741-AV
Customer's No.:

Acceptance

Microtips Technology Inc.
 12F. No.31 Lane 169, Kang Ning St.,
 His-Chih, Taipei Hsien, Taiwan
 FAX: 886-2-26958625

Approved and Checked by

Approved by	Checked by		Made by
			



Microtips Technology Inc.

Messrs.					
Product Specification	Model:	MTF-TQ35SN741-AV	Rev. No.	Issued Date.	Page.
			G	Jun.23, 08	3 / 29

Contents

1. GENERAL DESCRIPTION AND FEATURES	5
1.1 Features.....	5
1.2 General Specifications	5
2. BLOCK DIAGRAM	6
2.1 TFT-LCD Module (Interface System Structure) with Back Light Unit.....	6
2.2 LCM Driver IC Block.....	7
3. INPUT TERMINAL PIN ASSIGNMENT	8
3.1 CN1 Pin Assignment (LCD).....	8
4. OPTICAL CHARACTERISTICS	10
5. ABSOLUTE MAXIMUM RATINGS	13
5.1 Absolute Ratings of Environment.....	13
5.2 Maximum Ratings (Voltage Referenced to VSS)	13
6. ELECTRICAL CHARACTERISTICS	14
6.1 DC Electrical Characteristics	14
7. AC CHARACTERISTICS	15
7.1 Pixel timing	15
7.2 Data transaction timing in parallel RGB (24 bit) interface (SYNC mode)	16
7.3 Signal timing in DE mode	17
8. BACKLIGHT SPECIFICATIONS	18
8.1 Absolute Maximum Ratings	18
8.2 Electrical/Operating Characteristics	18
8.3 Electrical Circuit of Backlight.....	18
9. BASIC DISPLAY COLOR AND GRAY SCALE	19
10. QUALITY STANDARD	20
10.1 PURPOSE.....	20
10.2 SCOPE.....	20
10.3 QUALITY ASSURANCE	20
10.4 Sampling Condition	22
10.5 QUALITY ASSURANCE	23
11. RELIABILITY CONDITION	24
11.1 LCM Reliability Test	24
12. PRECAUTIONS	25
12.1 Operation	25
12.2 Safety.....	25
12.3 Handling.....	25
12.4 Static electricity	27



Microtips Technology Inc.

Messrs.					
Product Specification	Model:	MTF-TQ35SN741-AV	Rev. No.	Issued Date.	Page.
			G	Jun.23, 08	4 / 29

12.5 Storage	27
12.6 Cleaning	27
12.7 Waste	27
13. WARRANTY	28
14. DIMENSIONAL OUTLINES	28



Microtips Technology Inc.

Messrs.					
Product Specification	Model:	MTF-TQ35SN741-AV	Rev. No.	Issued Date.	Page.
			G	Jun.23, 08	5 / 29

1. GENERAL DESCRIPTION AND FEATURES

MTF-TQ35SN741-AV is a TM (Transmissive) type color active matrix TFT (Thin Film Transistor) liquid crystal display (LCD) that uses amorphous silicon TFT devices. This model is composed of a TFT-LCD module, a driver circuit and a back-light unit. The resolution of a 3.5" contains 320RGBx240 dots and can display up to 16.7M colors. The following table described the features of MTF-TQ35SN741-AV.

1.1 Features

- Support 24-bit parallel data (RGB).

1.2 General Specifications

Item	Specification	Unit	Note
Screen Size	3.5" diagonal	inch	--
Display Resolution	320 x RGB x 240	Dot	--
Dot Pitch	0.073 (W) x 0.219 (H)	mm	--
Active Area	70.08 (W) x 52.56 (H)	mm	--
Outline Dimension	77.8 (W) x 64.5 (H) x 3.0 (T), Not including FPCB	mm	--
Display Mode	Normally Black/Transmissive	-	--
Pixel Arrangement	RGB-Strip	--	--
Surface Treatment	Anti-glare (AG)	--	--
weight	33	g	--
Viewing Direction	6 o'clock	--	--
Input Interface	Digital 24-bits parallel RGB	-	--
Driver IC	Himax HX8238A	-	--

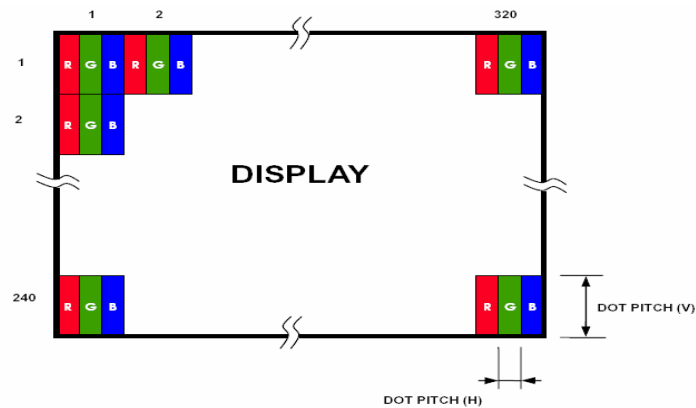

Pixel Arrangement



Microtips Technology Inc.

Messrs.					
Product Specification	Model:	MTF-TQ35SN741-AV	Rev. No.	Issued Date.	Page.
			G	Jun.23, 08	6 / 29

2. BLOCK DIAGRAM

2.1 TFT-LCD Module (Interface System Structure) with Back Light Unit

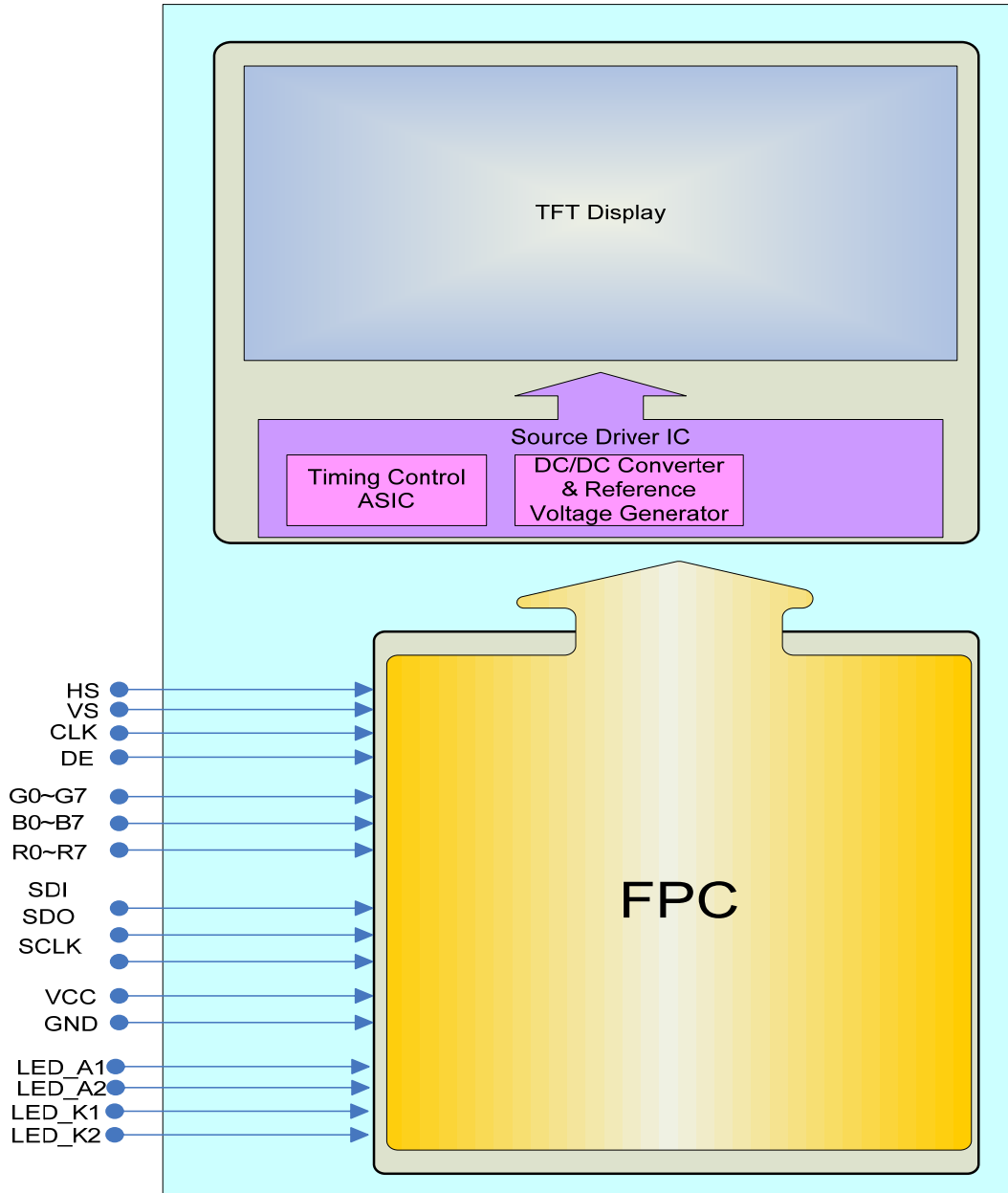

Microtips Technology Inc.

Messrs.					
Product Specification	Model:	MTF-TQ35SN741-AV	Rev. No.	Issued Date.	Page.
			G	Jun.23, 08	7 / 29

2.2 LCM Driver IC Block

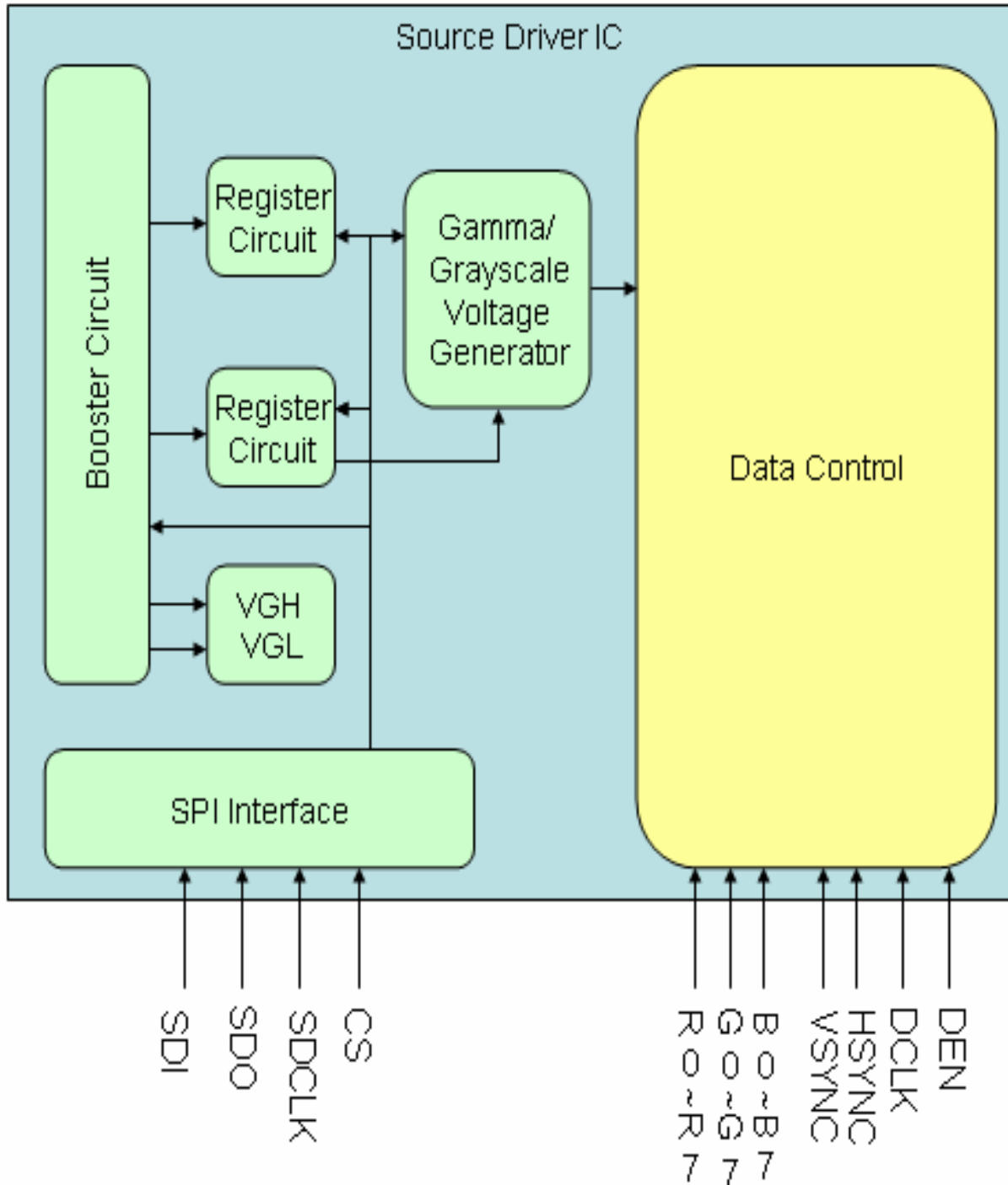

Microtips Technology Inc.

Messrs.					
Product Specification	Model:	MTF-TQ35SN741-AV	Rev. No.	Issued Date.	Page.
			G	Jun.23, 08	8 / 29

3. INPUT TERMINAL PIN ASSIGNMENT

3.1 CN1 Pin Assignment (LCD)

Pin No.	Symbol	I/O	Function	Remark
1	LED K1	I	Backlight LED Ground	
2	LED K2	I	Backlight LED Ground	
3	LED A1	I	Backlight LED Power (10.2V/20mA)	
4	LED A2	I	Backlight LED Power (10.2V/20mA)	
5	N/C	-	Not Connection	
6	/REST	I	Hardware Reset , internal Pull High (3.1V~3.3V) , Connect to 2.5V~3.6V when not used (Refer to Power Up Sequence)	
7	N/C	-	Not Connection	
8	N/C or Y1 (Top)	I	No connection (for MTF-TQ35SN741-AV) or Y1 (Top) (for MTF-TQ35SP741-AV)	
9	N/C or X1 (Right)	I	No connection (for MTF-TQ35SN741-AV) or X1 (Right) (for MTF-TQ35SP741-AV)	
10	N/C or Y2 (Bottom)	I	No connection (for MTF-TQ35SN741-AV) or Y2 (Bottom) (for MTF-TQ35SP741-AV)	
11	N/C or X2 (Left)	I	No connection (for MTF-TQ35SN741-AV) or X2 (Left) (for MTF-TQ35SP741-AV)	
12	B0	I	Blue Data Bit 0	
13	B1	I	Blue Data Bit 1	
14	B2	I	Blue Data Bit 2	
15	B3	I	Blue Data Bit 3	
16	B4	I	Blue Data Bit 4	
17	B5	I	Blue Data Bit 5	
18	B6	I	Blue Data Bit 6	
19	B7	I	Blue Data Bit 7	
20	G0	I	Green Data Bit0	
21	G1	I	Green Data Bit1	
22	G2	I	Green Data Bit2	
23	G3	I	Green Data Bit3	
24	G4	I	Green Data Bit4	
25	G5	I	Green Data Bit5	
26	G6	I	Green Data Bit6	
27	G7	I	Green Data Bit7	



Microtips Technology Inc.

Messrs.					
Product Specification	Model:	MTF-TQ35SN741-AV	Rev. No.	Issued Date.	Page.
			G	Jun.23, 08	9 / 29

28	R0	I	Red Data Bit0	
29	R1	I	Red Data Bit1	
30	R2	I	Red Data Bit2	
31	R3	I	Red Data Bit3	
32	R4	I	Red Data Bit4	
33	R5	I	Red Data Bit5	
34	R6	I	Red Data Bit6	
35	R7	I	Red Data Bit7	
36	H _{SYNC}	I	Horizontal Sync Input	Note 2
37	V _{SYNC}	I	Vertical Sync Input	Note 2
38	D _{CLK}	I	Dot Data Clock	
39	N/C	-	Not Connection	
40	N/C	-	Not Connection	
41	V _{CC}	I	Digital Power	3.3V
42	V _{CC}	I	Digital Power	3.3V
43	CSB	I	SPI Interface Data En Leave it open when not used!	Note 1
44	N/C	-	Not Connection	
45	N/C	-	Not Connection	
46	N/C	-	Not Connection	
47	N/C	I	Not Connection	
48	SDO	-	SPI Interface Data output Leave it open when not used!	Note 1
49	SP _{CLK}	I	SPI Interface Data Clock Leave it open when not used!	Note 1
50	SDI	I	SPI Interface Data input Leave it open when not used!	Note 1
51	N/C	-	Not Connection	
52	DEN	I	Data Enable Input, Internal Pull High (3.1V~3.3V) , Connect to 2.5V~3.6V or floating if not used.,	Note 3
53	GND	I	Ground	
54	GND	I	Ground	

Note 1: SPI Interface is only to set up the initial code in LCM driver IC register.

Note 2: There had been default initial code stored in LCD driver IC at Sync Mode operation, and if customer needs to revise the default initial code to change gamma or Vcom voltage, then SPI interface is needed.

Note 3: Different from Sync mode, there is no default initial code in driver IC in DE mode, so initial code has to be setup via SPI interface at DE mode.



Microtips Technology Inc.

Messrs.					
Product Specification	Model:	MTF-TQ35SN741-AV	Rev. No.	Issued Date.	Page.
			G	Jun.23, 08	10 / 29

4. OPTICAL CHARACTERISTICS

The following items are measured under stable conditions. The optical characteristics should be measured in a dark room or equivalent state with the methods shown in Note (1).

(Ta=25°C, Vcc = VCI=3.3V, If40mA)

Item		Symbol	Condition	Min	Type	Max	Unit	Note
Transmittance		T (%)	Viewing normal Angle $\theta_x=\theta_y=0^\circ$	-	7.4	-	%	All left side data are based on CMO's following condition-T6 NTSC:60% LC:5091 Light: C light (Machine:BM5A) Normal Polarizer without DBEF Simulation Data Reference only
Response time	Rise	T_R		-	15	30	ms	
	Fall	T_F		-	35	50	ms	
Brightness		L		200	250	-	cd/m ²	
Contrast ratio		CR		200	300	-	-	
Color Chromaticity	Red	R_x		-	0.591	-	-	
		R_y		-	0.373	-	-	
	Green	G_x		-	0.331	-	-	
		G_y		-	0.599	-	-	
	Blue	B_x		-	0.134	-	-	
		B_y	-	0.171	-	-		
	White	W_x	-	0.295	-	-		
		W_y	-	0.311	-	-		
Viewing Angle	Hor.	θ_{x+}	Center CR \geq 10	50	60	-	Degree	
		θ_{x-}		50	60	-		
	Ver.	θ_{y+}		40	50	-		
		θ_{y-}		50	60	-		

Note 1: Definition of Contrast Ratio (CR):

The contrast ratio can be calculated by the following expression.

Contrast Ratio (CR)= L63/L0

L63: Luminance of gray level 63

L0: Luminance of gray level 0

CR=CR (10)

CR(X) is corresponding to the Contrast Ratio of the point X at Figure in Note (5)



Microtips Technology Inc.

Messrs.					
Product Specification	Model:	MTF-TQ35SN741-AV	Rev. No.	Issued Date.	Page.
			G	Jun.23, 08	11 / 29

Note 2: Definition of Response Time (T_R T_F):

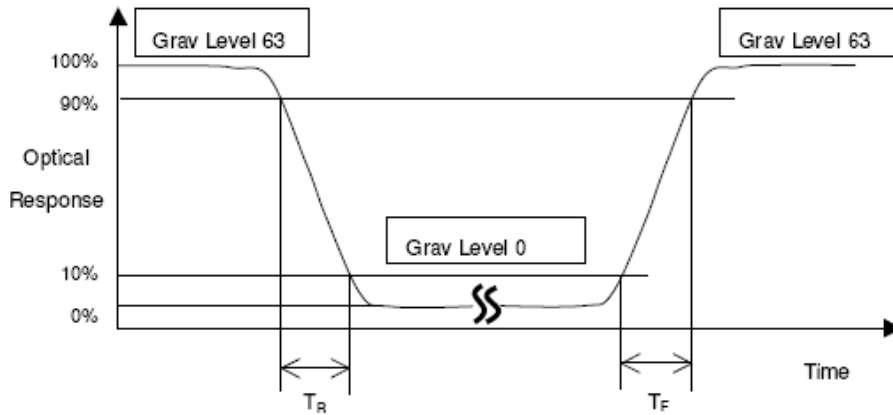

Note 3: Definition of Viewing Angle

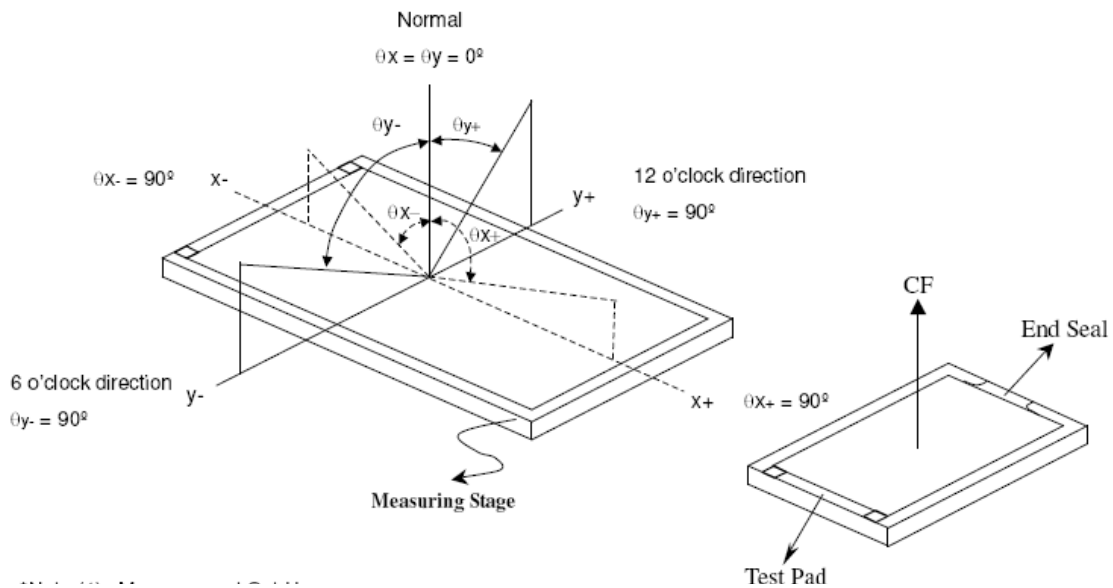

Microtips Technology Inc.

Messrs.					
Product Specification	Model:	MTF-TQ35SN741-AV	Rev. No.	Issued Date.	Page.
			G	Jun.23, 08	12 / 29

(4) Measurement Set-Up:

The LCD module should be stabilized at a given temperature for 20 minutes to avoid abrupt temperature Change during measuring. In order to stabilize the luminance, the measurement should be executed after lighting Backlight for 20 minutes in a windless room.

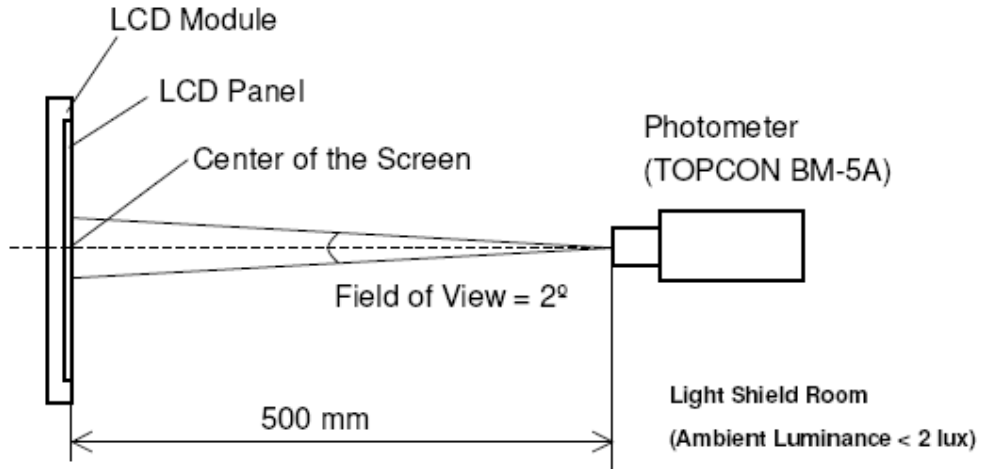

(5) Measurement Set-Up:

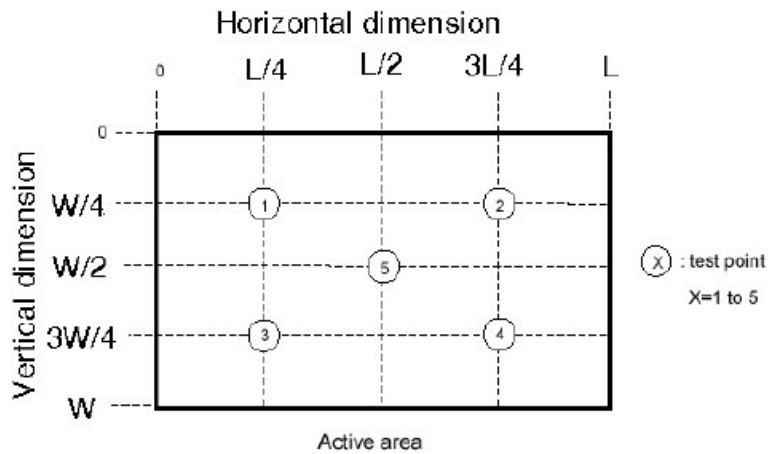

Microtips Technology Inc.

Messrs.					
Product Specification	Model:	MTF-TQ35SN741-AV	Rev. No.	Issued Date.	Page.
			G	Jun.23, 08	13 / 29

5. ABSOLUTE MAXIMUM RATINGS

5.1 Absolute Ratings of Environment

If the operating condition exceeds the following absolute maximum ratings, the TFT LCD module may be damaged permanently.

(Ta=25(2°C, VSS=GND=0)

Item	Symbol	Min.	Max.	Unit	Note
Storage temperature	TSTG	-30	80	°C	(1)
Operating temperature (Ambient temperature)	TOPR	-20	70	°C	(1), (2)

Note (1) 95 % RH Max. (40 °C ≥ Ta)

Maximum wet-bulb temperature at 39 °C or less. (Ta > 40 °C) No condensation.

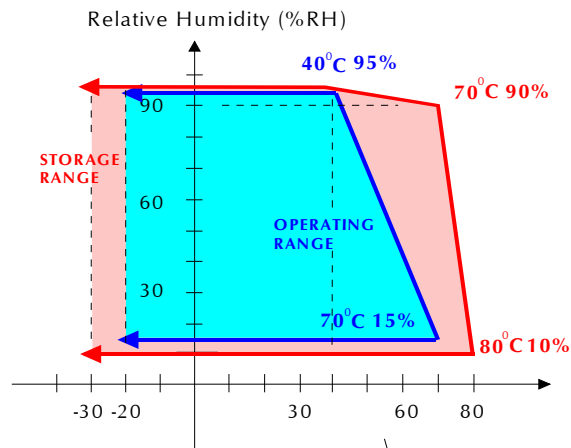

(2) In case of below 0°, the response time of liquid crystal (LC) becomes slower and the color of panel becomes darker than normal one. Level of retardation depends on temperature, because of LC's character

5.2 Maximum Ratings (Voltage Referenced to VSS)

Item	Symbol	Condition	Min.	Max.	Unit	Remark
Power voltage	VCC	VSS=0	-0.3	6.0	V	-
Input voltage	VBB _{inBB}	-	-0.3	VCC+0.3	V	Note 1

Note1: Hsync, Vsync, DEN, DCLK, R0~R7, G0~G7, B0~B7



Microtips Technology Inc.

Messrs.					
Product Specification	Model:	MTF-TQ35SN741-AV	Rev. No.	Issued Date.	Page.
			G	Jun.23, 08	14 / 29

6. ELECTRICAL CHARACTERISTICS

6.1 DC Electrical Characteristics

(Unless otherwise specified, Voltage Referenced to Vss, VCC=3.3V, Ta=25°C)

Item	Symbol	Value			Unit	Note	
		Min.	Typ.	Max.			
Power supply	VCC	3.0	3.3	3.6	V	-	
Input Voltage for logic	H Level	V_{IH}	0.7 VCC	-	VCC	V	Note 1
	L Level	V_{IL}	0	-	0.3 VCC	V	
Power Supply current	ICC	-	34.36	-	mA	Note 2	

Note1: Hsync, Vsync, DEN, DCLK, R0~R7, G0~G7, B0~B7

Note2: fV =60Hz , Ta=25°C , Display pattern : All Black



Microtips Technology Inc.

Messrs.					
Product Specification	Model:	MTF-TQ35SN741-AV	Rev. No.	Issued Date.	Page.
			G	Jun.23, 08	15 / 29

7. AC CHARACTERISTICS

7.1 Pixel timing

(Unless otherwise specified, Voltage Referenced to V_{SS} , $V_{CCIO}=3.3V$, $T_a=25^\circ C$)

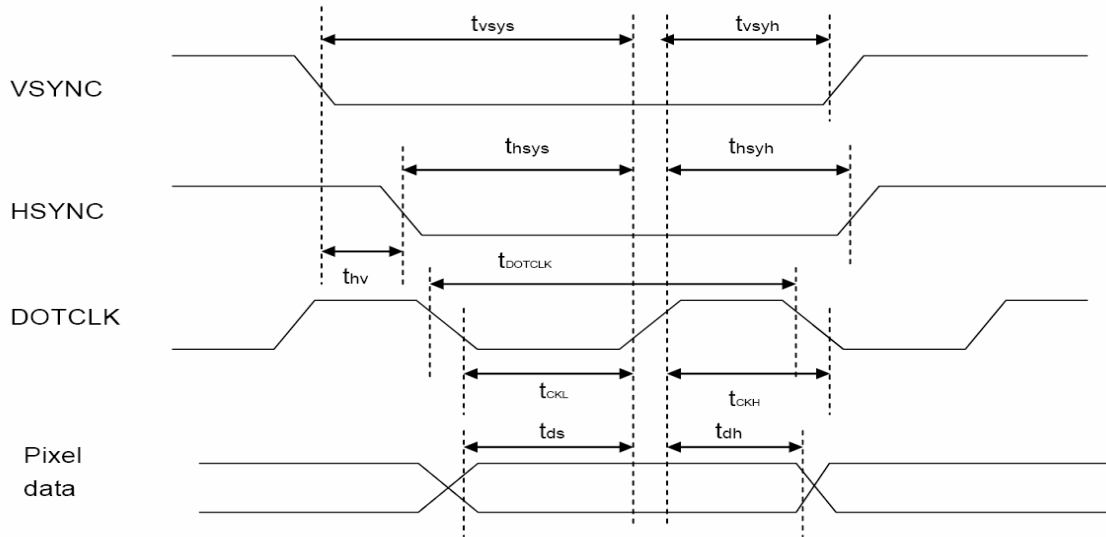

Pixel timing

PARAMETER	Symbol	Min.		Typ.		Max.		Unit
		24 bit	8 bit	24 bit	8 bit	24 bit	8 bit	
DOTCLK Frequency	fDOTCLK	-	-	6.5	19.5	10	30	MHz
DOTCLK Period	tDOTCLK	100	33.3	154	51.3	-	-	ns
Vertical Sync Setup Time	tvsys	20	10	-	-	-	-	ns
Vertical Sync Hold Time	tvsyh	20	10	-	-	-	-	ns
Horizontal Sync Setup Time	thsys	20	10	-	-	-	-	ns
Horizontal Sync Hold Time	thsyh	20	10	-	-	-	-	ns
Phase difference of Sync Signal Falling Edge	thv	1		-		240		tDOTCLK
DOTCLK Low Period	tCKL	50	15	-	-	-	-	ns
DOTCLK High Period	tCKH	50	15	-	-	-	-	ns
Data Setup Time	tds	12	10	-	-	-	-	ns
Data hold Time	tdh	12	10	-	-	-	-	ns
Reset Pulse Width	tRES	10		-	-	-	-	us

Note: External clock source must be provided to DOTCLK pin of HX8238-A. The driver will not operate if absent of the clocking signal.



Microtips Technology Inc.

Messrs.					
Product Specification	Model:	MTF-TQ35SN741-AV	Rev. No.	Issued Date.	Page.
			G	Jun.23, 08	16 / 29

7.2 Data transaction timing in parallel RGB (24 bit) interface (SYNC mode)

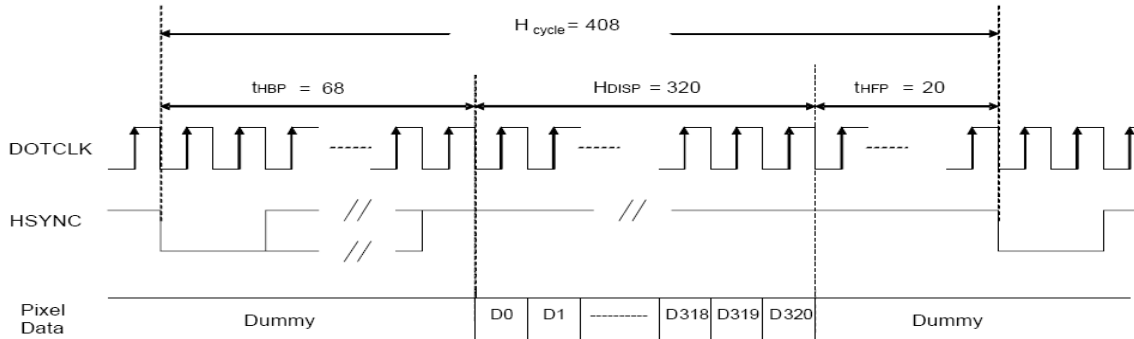

a) Horizontal Data Transaction Timing

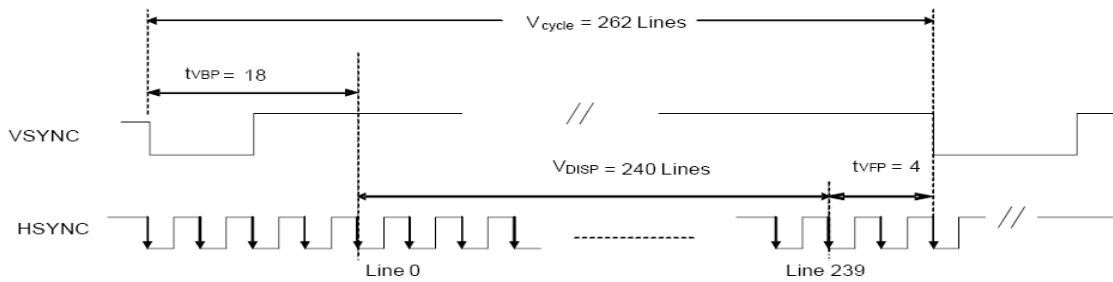

b) Vertical Data Transaction Timing

Data transaction timing in parallel RGB (24 bit) interface (SYNC mode)

PARAMETER	Symbol	Min.		Typ.		Max.		Unit
		24 bit	8 bit	24 bit	8 bit	24 bit	8 bit	
DOTCLK Frequency	fDOTCLK	-	-	6.5	19.5	10	30	MHz
DOTCLK Period	tDOTCL	100	33.3	154	51.3	-	-	Ns
Horizontal Frequency (Line)	fH	-	-	14.9	-	22.35	-	KHz
Vertical Frequency (Refresh)	fV	-	-	60	-	90	-	Hz
Horizontal Back Porch	tHBP	-	-	68	204	-	-	tDOTCLK
Horizontal Front Porch	tHFP	-	-	20	60	-	-	tDOTCLK
Horizontal Data Start Point	tHBP	-	-	68	204	-	-	tDOTCLK
Horizontal Blanking Period	tHBP+tHFP	-	-	88	264	-	-	tDOTCLK
Horizontal Display Area	HDISP	-	-	320	960	-	-	tDOTCLK
Horizontal Cycle	Hcycle	-	-	408	1224	450	1350	tDOTCLK



Microtips Technology Inc.

Messrs.					
Product Specification	Model:	MTF-TQ35SN741-AV	Rev. No.	Issued Date.	Page.
			G	Jun.23, 08	17 / 29

7.3 Signal timing in DE mode

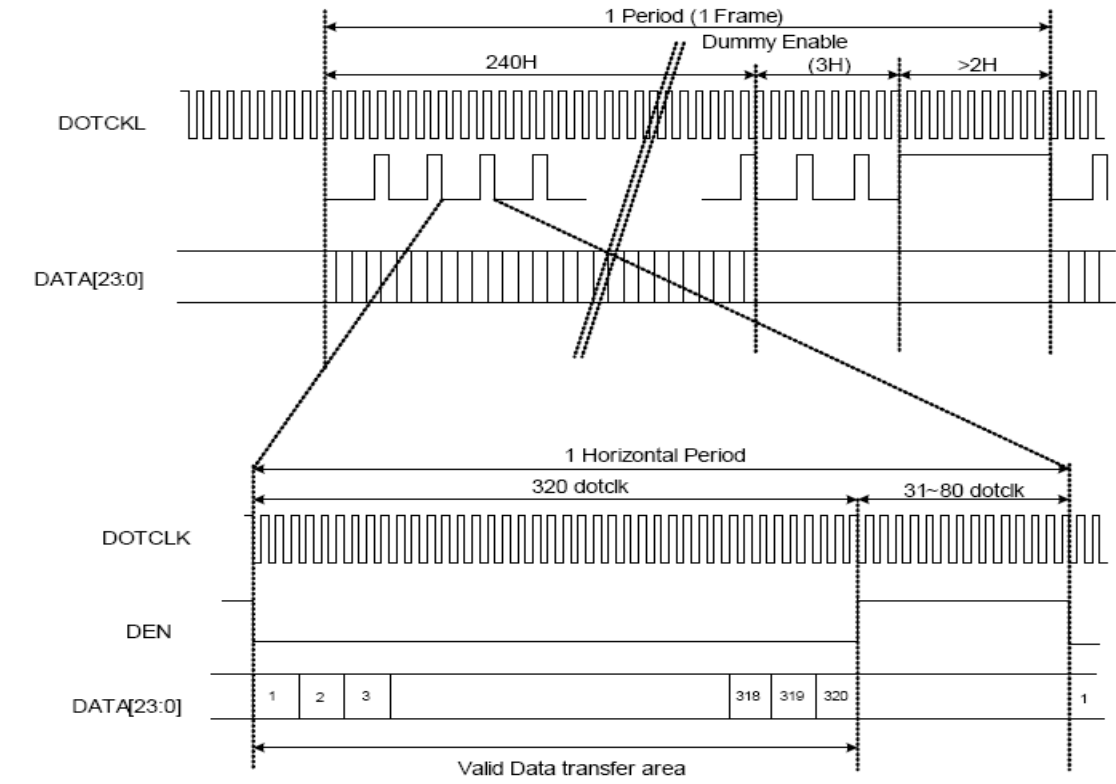

Microtips Technology Inc.

Messrs.					
Product Specification	Model:	MTF-TQ35SN741-AV	Rev. No.	Issued Date.	Page.
			G	Jun.23, 08	18 / 29

8. BACKLIGHT SPECIFICATIONS

8.1 Absolute Maximum Ratings

Ta = 25°C

Parameter	Symbol	Maximun Rating	Units
Peak Forward Current	I _{FM}	40	mA
Reverse Voltage	V _R	20	V
Power Dissipation	P _d	456	mW
Operating Temperature	T _{OPR}	-20~+70	°C
Storage Temperature	T _{STG}	-30~+80	°C

8.2 Electrical/Operating Characteristics

Ta = 25°C

Parameter	Symbol	Min.	Typ.	Max.	Units	Test Condition
Forward Voltage(VLED1\VLED2)	V _F	9.0	10.2	11.4	V	Ta=25°C IF=40mA
LED (1+2) Current	I _L	-	20+20	-	mA	
Uniformity	P _D	75	-	-	%	
Chromaticity Coordinates	X	0.27	0.30	0.32	-	
	Y	0.27	0.31	0.33	-	
LED Dice life time	-	-	40000	-	Hours	-

*Uniformity = (Min./Max.) x 100%

8.3 Electrical Circuit of Backlight

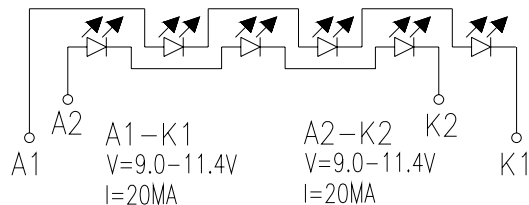

Microtips Technology Inc.

Messrs.					
Product Specification	Model:	MTF-TQ35SN741-AV	Rev. No.	Issued Date.	Page.
			G	Jun.23, 08	19 / 29

9. BASIC DISPLAY COLOR AND GRAY SCALE

	Color & Gray Scale	Data Signal																	
		R5	R4	R3	R2	R1	R0	G5	G4	G3	G2	G1	G0	B5	B4	B3	B2	B1	B0
Basic Color	Black	1	1	1	1	1	1	1	1	1	1	1	1	1	1	1	1	1	1
	Red(0)	0	0	0	0	0	0	1	1	1	1	1	1	1	1	1	1	1	1
	Green(0)	1	1	1	1	1	1	0	0	0	0	0	0	1	1	1	1	1	1
	Blue(0)	1	1	1	1	1	1	1	1	1	1	1	1	0	0	0	0	0	0
	Cyan	1	1	1	1	1	1	0	0	0	0	0	0	0	0	0	0	0	0
	Magenta	0	0	0	0	0	0	1	1	1	1	1	1	0	0	0	0	0	0
	Yellow	0	0	0	0	0	0	0	0	0	0	0	0	1	1	1	1	1	1
	White	0	0	0	0	0	0	0	0	0	0	0	0	0	0	0	0	0	0
Red	Black	1	1	1	1	1	1	1	1	1	1	1	1	1	1	1	1	1	1
	Red(62)	1	1	1	1	1	0	1	1	1	1	1	1	1	1	1	1	1	1
	Red(61)	1	1	1	1	0	1	1	1	1	1	1	1	1	1	1	1	1	1
	:	:	:	:	:	:	:	:	:	:	:	:	:	:	:	:	:	:	:
	Red(31)	1	0	0	0	0	0	1	1	1	1	1	1	1	1	1	1	1	1
	:	:	:	:	:	:	:	:	:	:	:	:	:	:	:	:	:	:	:
	Red(1)	0	0	0	0	0	1	1	1	1	1	1	1	1	1	1	1	1	1
	Red(0)	0	0	0	0	0	0	1	1	1	1	1	1	1	1	1	1	1	0
Green	Black	1	1	1	1	1	1	1	1	1	1	1	1	1	1	1	1	1	1
	Green(62)	1	1	1	1	1	1	1	1	1	1	1	0	1	1	1	1	1	1
	Green(61)	1	1	1	1	1	1	1	1	1	1	0	1	1	1	1	1	1	1
	:	:	:	:	:	:	:	:	:	:	:	:	:	:	:	:	:	:	:
	Green(31)	1	1	1	1	1	1	1	0	0	0	0	1	1	1	1	1	1	1
	:	:	:	:	:	:	:	:	:	:	:	:	:	:	:	:	:	:	:
	Green(1)	1	1	1	1	1	1	0	0	0	0	0	1	1	1	1	1	1	1
	Green(0)	1	1	1	1	1	1	0	0	0	0	0	0	1	1	1	1	1	1
Blue	Black	1	1	1	1	1	1	1	1	1	1	1	1	1	1	1	1	1	1
	Blue(62)	1	1	1	1	1	1	1	1	1	1	1	1	1	1	1	1	1	0
	Blue(61)	1	1	1	1	1	1	1	1	1	1	1	1	1	1	1	1	0	1
	:	:	:	:	:	:	:	:	:	:	:	:	:	:	:	:	:	:	:
	Blue(31)	1	1	1	1	1	1	1	1	1	1	1	1	1	0	0	0	0	0
	:	:	:	:	:	:	:	:	:	:	:	:	:	:	:	:	:	:	:
	Blue(1)	1	1	1	1	1	1	1	1	1	1	1	1	0	0	0	0	0	1
	Blue(0)	1	1	1	1	1	1	1	1	1	1	1	1	0	0	0	0	0	0

0: Low level voltage, 1: High level voltage

Each basic color can be displayed in 64 gray scales from 6 bit data signals. With the combination of total 18 bit data signals, the 262,144-color display can be achieved on the screen.



Microtips Technology Inc.

Messrs.					
Product Specification	Model:	MTF-TQ35SN741-AV	Rev. No.	Issued Date.	Page.
			G	Jun.23, 08	20 / 29

10. QUALITY STANDARD

10.1 PURPOSE

These reliability test items and inspection standards shall be applied to LCM supplied by Microtips Corporation.

10.2 SCOPE

Applicable for MTF-TQ35SN741-AV For Microtips use only..

10.3 QUALITY ASSURANCE

10.3.1 Inspection conditions

The LCD shall be inspected under 40W (300~500Lux) white fluorescent light.

$\theta \leq 45^\circ$ inspection under non-operating condition.

$\theta \leq 45^\circ$ inspection under operating condition.

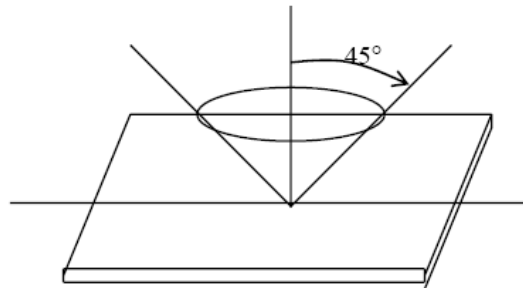

10.3.2 Definition of applicable Zones

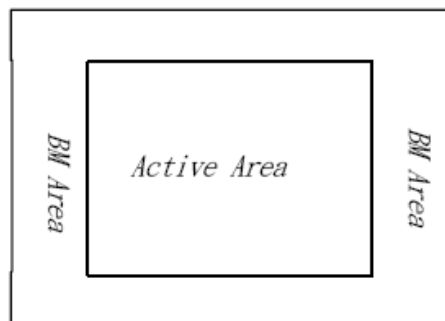

Microtips Technology Inc.

Messrs.					
Product Specification	Model:	MTF-TQ35SN741-AV	Rev. No.	Issued Date.	Page.
			G	Jun.23, 08	21 / 29

10.3.3 Inspection Parameters

No.	Parameter	Criteria														
1	Operating	Display function: No Display malfunction (Major)														
		Contrast ratio (Black White): Does not meet specified range in the spec. (Major)(Note:3)														
		Line Defect: No obvious Vertical and Horizontal line defect in bright, dark and colored. (Major)(Note:1)														
		Point Defect (Red, green, blue, dark): Active area ≤ 4 (Major)(Note1)														
		<table border="1"> <thead> <tr> <th rowspan="2">Item</th> <th>Acceptable</th> </tr> <tr> <th>Active Area</th> </tr> </thead> <tbody> <tr> <td>Bright</td> <td>2</td> </tr> <tr> <td>Dark</td> <td>3</td> </tr> <tr> <td>Total</td> <td>4</td> </tr> </tbody> </table>	Item	Acceptable	Active Area	Bright	2	Dark	3	Total	4					
		Item		Acceptable												
			Active Area													
		Bright	2													
		Dark	3													
		Total	4													
Non-uniformity: Visible through 6%ND filer.(Major)																
Foreign material in Black or White spots shape ($W > 1/4L$)																
<table border="1"> <thead> <tr> <th>Zone Dimension</th> <th>Acceptable number</th> <th rowspan="4">Class of Defects</th> <th rowspan="4">AQL Level</th> </tr> </thead> <tbody> <tr> <td>$D > 0.3$</td> <td>0</td> </tr> <tr> <td>$0.1 \leq D \leq 0.3$</td> <td>4</td> </tr> <tr> <td>$D \leq 0.1$</td> <td>*</td> </tr> </tbody> </table>	Zone Dimension	Acceptable number	Class of Defects	AQL Level	$D > 0.3$	0	$0.1 \leq D \leq 0.3$	4	$D \leq 0.1$	*						
Zone Dimension	Acceptable number	Class of Defects			AQL Level											
$D > 0.3$	0															
$0.1 \leq D \leq 0.3$	4															
$D \leq 0.1$	*															
D= (Long + Short)/2 *:Disregard																
Foreign Material in Line or spiral shape ($W \leq 1/4L$) (note:4)																
<table border="1"> <thead> <tr> <th>L(mm)</th> <th>Zone W(mm)</th> <th>Acceptable number</th> <th rowspan="3">Class of Defects</th> <th rowspan="3">AQL Level</th> </tr> </thead> <tbody> <tr> <td>$L > 2$</td> <td>$W > 0.1$</td> <td>0</td> </tr> <tr> <td>$0.5 < L \leq 2$</td> <td>$0.05 < W \leq 0.1$</td> <td>1</td> </tr> <tr> <td>$L \leq 0.5$</td> <td>$W \leq 0.05$</td> <td>*</td> <td>Minor</td> <td>1.5</td> </tr> </tbody> </table>	L(mm)	Zone W(mm)	Acceptable number	Class of Defects	AQL Level	$L > 2$	$W > 0.1$	0	$0.5 < L \leq 2$	$0.05 < W \leq 0.1$	1	$L \leq 0.5$	$W \leq 0.05$	*	Minor	1.5
L(mm)	Zone W(mm)	Acceptable number	Class of Defects			AQL Level										
$L > 2$	$W > 0.1$	0														
$0.5 < L \leq 2$	$0.05 < W \leq 0.1$	1														
$L \leq 0.5$	$W \leq 0.05$	*	Minor	1.5												
L: Length W: Width *: Disregard																
2	External Inspection (non-operating)	Dimension: Outline (Major)														
		Bezel appearance: uneven (Minor)														
		Scratch on the polarize: (Note:2)														
		<table border="1"> <thead> <tr> <th>W(mm)</th> <th>L(mm)</th> <th>Acceptable number</th> <th rowspan="3">Class of Defects</th> <th rowspan="3">AOL Level</th> </tr> </thead> <tbody> <tr> <td>$W > 0.05$</td> <td>$L \leq 1$</td> <td>0</td> </tr> <tr> <td>$W \leq 0.05$</td> <td>$L \leq 2$</td> <td>3</td> </tr> </tbody> </table>	W(mm)	L(mm)	Acceptable number	Class of Defects	AOL Level	$W > 0.05$	$L \leq 1$	0	$W \leq 0.05$	$L \leq 2$	3			
		W(mm)	L(mm)	Acceptable number	Class of Defects			AOL Level								
		$W > 0.05$	$L \leq 1$	0												
		$W \leq 0.05$	$L \leq 2$	3												
L: Length W: Width *: Disregard																
Dent or bubble on the polarize (Note:2)																
<table border="1"> <thead> <tr> <th>Zone Dimension</th> <th>Acceptable number</th> <th rowspan="3">Class of Defects</th> <th rowspan="3">AQL Level</th> </tr> </thead> <tbody> <tr> <td>$D \leq 0.05$</td> <td>*</td> </tr> <tr> <td>$D \leq 0.3$</td> <td>3</td> </tr> </tbody> </table>	Zone Dimension	Acceptable number	Class of Defects	AQL Level	$D \leq 0.05$	*	$D \leq 0.3$	3								
Zone Dimension	Acceptable number	Class of Defects			AQL Level											
$D \leq 0.05$	*															
$D \leq 0.3$	3															
D= (Long + Short)/2 *:Disregard																



Microtips Technology Inc.

Messrs.					
Product Specification	Model:	MTF-TQ35SN741-AV	Rev. No.	Issued Date.	Page.
			G	Jun.23, 08	22 / 29

Class of defects	Major	AQL 0.65%	Definition
	Minor	AQL 1.5%	It is a defect that will not result in functioning problem with deviation classified.

- Note:1.(a)Bright point defect is defined as point defect of R,G,B with area $>1/2$ pixel respectively
(b)Dark point defect is defined as visible in full white pattern.
(c)Definition of distribution of point defect is as follows:
- minimum separation between dark point defects should be larger than 5mm.
- minimum separation between bright point defects should be larger than 5mm.
(d)Definition of joined bright point defect and joined dark point defect are as follows:
- Two or more joined bright point defects must be nil.
- Three joined dark point defects must be nil.
- Coupling of one dark and one bright point in junction is counted as one dark and bright spot with 1 pair maximum.
- Two Joined dark point is counted as two dark point with 2 pair maximum.
(e) Lin defect is defined as visible by using 10% ND filter.
Note:2 The external inspection should be conducted at the distance 30 ± 5 cm between the eyes of inspector and the panel .
Note:3 Luminance measurement for contrast ratio is at the distance 50 ± 5 cm between the detective head and the panel with ambient illuminance less than 1 lux. Contrast ratio is obtained at optimum view angle.
Note:4 W-Width in mm , L-length of Max.(L1,L2) in mm.

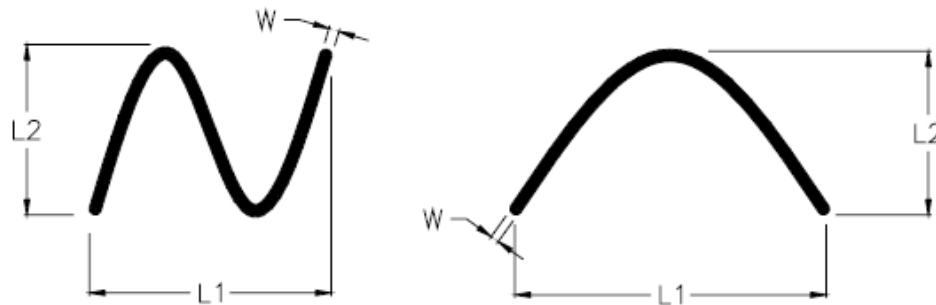

10.4 Sampling Condition

Unless otherwise agree in written, the sampling inspection shall be applied to the incoming inspection of customer.

Lot size: Quantity of shipment lot per model.

Sampling type: normal inspection, single sampling

Sampling table: MIL-STD-105E

Inspection level: Level II



Microtips Technology Inc.

Messrs.					
Product Specification	Model:	MTF-TQ35SN741-AV	Rev. No.	Issued Date.	Page.
			G	Jun.23, 08	23 / 29

10.5 QUALITY ASSURANCE

1. LIQUID CRYSTAL DISPLAY (LCD)

LCD is made up of glass, organic sealant, organic fluid, and polymer based polarizers. The following precautions should be taken when handling.

- (1). Keep the temperature within range of use and storage. Excessive temperature and humidity could cause polarization degradation, polarizer peel off or bubble.
- (2). Do not contact the exposed polarizers with anything harder than an HB pencil lead. To clean dust off the display surface, wipe gently with cotton, chamois or other soft material soaked in petroleum benzin.
- (3). Wipe off saliva or water drops immediately. Contact with water over a long period of time may cause polarizer deformation or color fading, while an active LCD with water condensation on its surface will cause corrosion of ITO electrodes.
- (4). Glass can be easily chipped or cracked from rough handling, especially at corners and edges.
- (5). Do not drive LCD with DC voltage.

2. Liquid Crystal Display Modules

2.1 Mechanical Considerations

LCM are assembled and adjusted with a high degree of precision. Avoid excessive shocks and do not make any alterations or modifications. The following should be noted.

- (1). Do not tamper in any way with the tabs on the metal frame.
- (2). Do not modify the PCB by drilling extra holes, changing its outline, moving its components or modifying its pattern.
- (3). Do not touch the elastomer connector, especially insert an backlight panel (for example, EL).
- (4). When mounting a LCM make sure that the PCB is not under any stress such as bending or twisting. Elastomer contacts are very delicate and missing pixels could result from slight dislocation of any of the elements.
- (5). Avoid pressing on the metal bezel, otherwise the elastomer connector could be deformed and lose contact, resulting in missing pixels.

2.2. Static Electricity

LCM contains CMOS LSI's and the same precaution for such devices should apply, namely

- (1). The operator should be grounded whenever he/she comes into contact with the module. Never touch any of the conductive parts such as the LSI pads, the copper leads on the PCB and the interface terminals with any parts of the human body.
- (2). The modules should be kept in antistatic bags or other containers resistant to static for storage.
- (3). Only properly grounded soldering irons should be used.
- (4). If an electric screwdriver is used, it should be well grounded and shielded from commutator sparks.

(5) The normal static prevention measures should be observed for work clothes and working benches; for the latter conductive (rubber) mat is recommended.

(6). Since dry air is inductive to statics, a relative humidity of 50-60% is recommended.

2.3 Soldering

- (1). Solder only to the I/O terminals.
- (2). Use only soldering irons with proper grounding and no leakage.
- (3). Soldering temperature : $280^{\circ}\text{C} \pm 10^{\circ}\text{C}$
- (4). Soldering time: 3 to 4 sec.
- (5). Use eutectic solder with resin flux fill.
- (6). If flux is used, the LCD surface should be covered to avoid flux spatters. Flux residue should be removed after wards.

2.4 Operation

- (1). The viewing angle can be adjusted by varying the LCD driving voltage V0.
- (2). Driving voltage should be kept within specified range; excess voltage shortens display life.
- (3). Response time increases with decrease in temperature.
- (4). Display may turn black or dark blue at temperatures above its operational range; this is (however not pressing on the viewing area) may cause the segments to appear "fractured".
- (5). Mechanical disturbance during operation (such as pressing on the viewing area) may cause the segments to appear "fractured".

2.5 Storage

If any fluid leaks out of a damaged glass cell, wash off any human part that comes into contact with soap and water. Never swallow the fluid. The toxicity is extremely low but caution should be exercised at all the time.

2.6 Limited Warranty

Unless otherwise agreed between Microtips and customer, Microtips will replace or repair any of its LCD and LCM which is found to be defective electrically and visually when inspected in accordance with Microtips acceptance standards, for a period on one year from date of shipment. Confirmation of such date shall be based on freight documents. The warranty liability of Microtips is limited to repair and/or replacement on the terms set forth above. Microtips will not responsible for any subsequent or consequential events.



Microtips Technology Inc.

Messrs.					
Product Specification	Model:	MTF-TQ35SN741-AV	Rev. No.	Issued Date.	Page.
			G	Jun.23, 08	24 / 29

11. RELIABILITY CONDITION

11.1 LCM Reliability Test

11.1.1 Reliability Test Condition

No.	TFT	Item	Condition	Test time	Note
1	V	High temp. operating	70°C	240 Hrs	-
2	V	Low temp. operating	-20°C	240 Hrs	-
3	V	High temp. storage	80°C	240 Hrs	-
4	V	Low temp. storage	-30°C	240 Hrs	-
5	V	High Temp / High Humidity Storage	T = 60°C /90%. For (But no condensation dew)	240 Hrs	-
6	V	High Temp/ High Humidity Operating	T = 40°C /90% For (But no condensation dew)	240 Hrs	-
7	V	Thermal Shock	-30°C → +25°C → +80°C, 50 cycle 30min 5min 30min	-	-



Microtips Technology Inc.

Messrs.					
Product Specification	Model:	MTF-TQ35SN741-AV	Rev. No.	Issued Date.	Page.
			G	Jun.23, 08	25 / 29

12. PRECAUTIONS





12.1 Operation

Burn-in sometimes happens when the same character was displayed at along time. Therefore, to prevent Burn-in, it is recommended to set up a Screen-saver function.

12.2 Safety

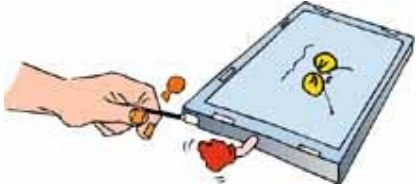
The liquid crystal in the LCD is poisonous, DO NOT put it in your mouth. If the liquid crystal touches your skin or clothes, wash it off immediately using soap and water.



12.3 Handling

	<p>a. The LCD module shall be installed flat, without twisting or bending. b. COF or FPC has narrow pattern width, so easily become open circuit by external force. DO NOT apply pressure to COF or FPC especially in bending area.</p>
	<p>c. To avoid damage in appearance or malfunction, DO NOT subject the module to mechanical shock or to excessive force on its surface.</p>
	<p>d. The polarizer attached to the display is very easy to damage, handle it with care to avoid scratching.</p>
	<p>e. To avoid contamination on the display surface, DO NOT touch the display surface with bare hands. f. Provide a space so that the LCD module does not come into contact with other components.</p>



Microtips Technology Inc.

Messrs.					
Product Specification	Model:	MTF-TQ35SN741-AV	Rev. No.	Issued Date.	Page.
			G	Jun.23, 08	26 / 29

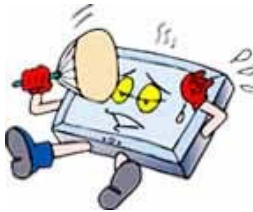
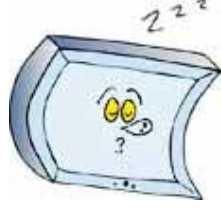
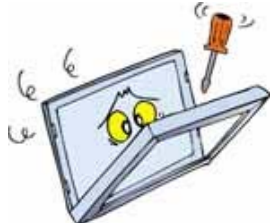
	<p>g. To protect the LCD panel from external pressure, put covering glass (acrylic board or similar board) to keep appropriate space between them.</p>
	<p>h. Be careful for condensation at sudden temperature change. Condensation makes damage to polarizer or electrical contacted parts. And after fading condensation, smear or spot will occur.</p>
	<p>i. Property of semiconductor devices may be affected when they are exposed to light possibly resulting in malfunctioning of the ICs. To prevent such malfunctioning of the ICs, your design and mounting layout done are so that the IC is not exposed to light in actual use.</p>
	<p>j. Strong light exposure causes degradation of color filter. It may not recover</p>
	<p>k. DO NOT contact with water to avoid Metal corrosion. l. When it is not in use, the screen must be turned off or the pattern must be frequently changed by a screen saver. If it displays the same pattern for a long period of time, brightness down/image sticking may develop due to the LCD structure.</p>
	<p>m. Never disassemble LCD product under any circumstances. If unqualified operators or users assemble the product after disassembling it, it may not function or its operation may be seriously affected.</p>



Microtips Technology Inc.

Messrs.					
Product Specification	Model:	MTF-TQ35SN741-AV	Rev. No.	Issued Date.	Page.
			G	Jun.23, 08	27 / 29

12.4 Static electricity

Since a module is composed of electronic circuits, it is not strong to electrostatic discharge.

	<ol style="list-style-type: none"> The LCD module shall be installed flat, without twisting or bending. Ground soldering iron tips, tools and testers when they operate. Ground your body when handling the products. DO NOT apply voltage to the input terminal without applying power supply. DO NOT apply voltage that exceeds the absolute maximum rating. Store the products in an anti-electrostatic container. Peel off protect tape, attached to polarizer, slowly to minimize ESD damage.
---	--

12.5 Storage

	<p>Store the products in a dark place at +5 ~ +25 degree C, low humidity (50%RH or less). DO NOT store the products in an atmosphere containing organic solvents or corrosive gases.</p>
---	--

12.6 Cleaning

	<ol style="list-style-type: none"> DO NOT wipe the polarizer with dry cloth, as it might cause scratch. Wipe the polarizer with a soft cloth soaked with petroleum IPA, other chemical might damage.
---	--

12.7 Waste

	<p>When dispose of LCD module, manage it at the production waste according to the relevant laws and regulations.</p>
---	--



Microtips Technology Inc.

Messrs.					
Product Specification	Model:	MTF-TQ35SN741-AV	Rev. No.	Issued Date.	Page.
			G	Jun.23, 08	28 / 29

13. WARRANTY

This product has been manufactured to your company's specifications as a part for use in your company's general electronic products. It is guaranteed to perform according to delivery specifications. For any other use apart from general electronic equipment, we cannot take responsibility if the product is used in medical devices, nuclear power control equipment, aerospace equipment, fire and security systems, or any other applications in which there is a direct risk to human life and where extremely high levels of reliability are required. If the product is to be used in any of the above applications, we will need to enter into a separate product liability agreement.

- 1 We cannot accept responsibility for any defect, which may arise from additional manufacturing of the product (including disassembly and reassembly), after product delivery.
- 2 We cannot accept responsibility for any defect, which may arise after the application of strong external force to the product.
- 3 We cannot accept responsibility for any defect, which may arise due to the application of static electricity after the product has passed your company's acceptance inspection procedures.
- 4 We cannot accept responsibility for industrial property, which may arise through the use of your product, with exception to those issues relating directly to the structure or method of manufacturing of our product. Microtips-origin longer than one year from Microtips production.

14. DIMENSIONAL OUTLINES

See Next page.....



Microtips Technology Inc.

