

HDA430-3

Dimensional Drawing

4.3", 480x272 , TFT, Transmissive Color, Landscape, White LED Backlight

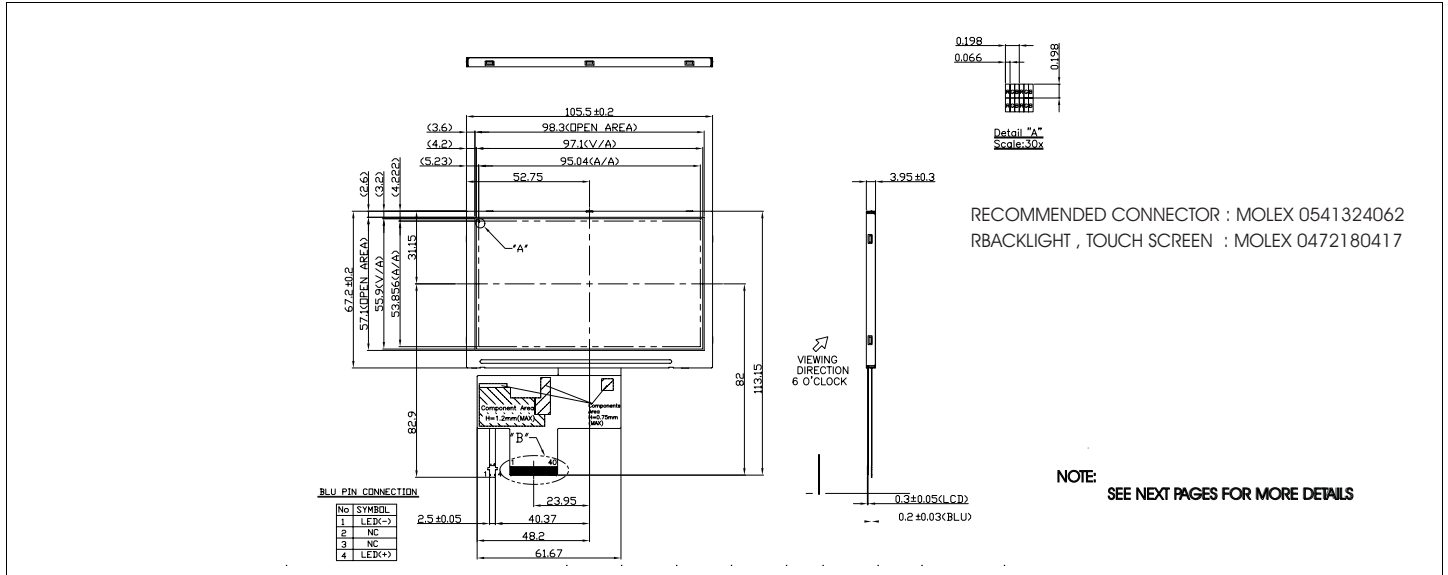

Features

- Viewing Angle(H/V).....130/110 degrees
- High Contrast.....450.
- Fast Response Time.....20 msec
- Built-in DC-DC Converter
- Built-in Controller.....none
- Touch screenoptional

Electrical Characteristics (VDD=3.3±0.125V 25°C)

PARAMETER	SYM	CONDITION	MIN	TYP	MAX	UNIT
OPERATING VOLTAGE	V _{DD}	-	3.0	3.3	3.6	V
INPUT HIGH VOLTAGE	V _{HI}	-	0.7V _{DD}	-	V _{DD}	V
INPUT LOW VOLTAGE	V _{LI}	-	0	-	0.3V _{DD}	V
OPERATING CURRENT	I _{DD}	-	-	22.8	31.92	mA
LED OPERATING VOLTAGE	V _{LED}	-	-	23.1	-	V
OPERATING CURRENT	I _{FLED}	-	-	20	-	mA
POWER CONSUMPTION	P _D	-	-	537.2	-	mW
BRIGHTNESS	L	-	400-	500	-	cd/m ²

Physical Data

- Module Size.....105.5W x67.2H x 3.95T mm
- Viewing Area Size.....95.04W x 53.85H mm
- Dot Pitch.....0.198W x 0.198H mm
- Weight.....43.5g

Pin Connections

PIN NO.	SYMBOL	FUNCTION	
1-2	GND	I	Ground
3-4	VDD	I	+ 3.3V Power Supply
5	R0	H/L	Red Data Bit 0
6	R1	H/L	Red Data Bit 1
7	R2	H/L	Red Data Bit 2
8	R3	H/L	Red Data Bit 3
9	R4	H/L	Red Data Bit 4
10	R5	H/L	Red Data Bit 5
11	R6	H/L	Red Data Bit 6
12	R7	H/L	Red Data Bit 7
13	G0	H/L	Green Data Bit 0I
14	G1	H/L	Green Data Bit 1I
15	G2	H/L	Green Data Bit 2I
16	G3	H/L	Green Data Bit 3I
17	G4	H/L	Green Data Bit 4I
18	G5	H/L	Green Data Bit 5I
19	G6	H/L	Green Data Bit 6I
20	G7	H/L	Green Data Bit 7I
21	B0	H/L	Blue Data Bit 0I
22	B1	H/L	Blue Data Bit 1I
23	B2	H/L	Blue Data Bit 2I
24	B3	H/L	Blue Data Bit 3I
25	B4	H/L	Blue Data Bit 4I
26	B5	H/L	Blue Data Bit 5I
27	B6	H/L	Blue Data Bit 6I
28	B7	H/L	Blue Data Bit 7I
29	GND	I	Ground
30	PCLK	H/L	Data Clock
31	DISP	H/L	Display ON/OFF (H/L)
32	HSYNC	H	Horizontal Sync
33	VSYNC	H	Vertical Sync
34	NC	-	No Connection
35-36	NC	-	No Connection
37	NC	-	No Connection
38	NC	-	No Connection
39	NC	-	No Connection
40	NC	-	No Connection

Power Supply

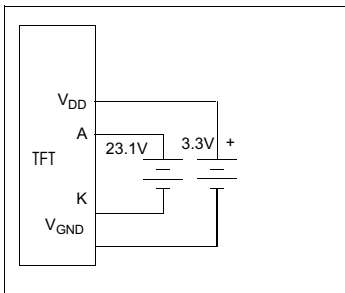

Absolute Maximum Ratings

PARAMETER	SYMBOL	MIN	MAX	UNIT
SUPPLY VOLTAGE	V _{DD}	0	4.0	V
BACKLIGHT CURRENT (LED)	I _{LED}	-	30	mA
INPUT VOLTAGE	V _{IN}	-0.3	V _{DD} +0.3	V
OPERATING TEMPERATURE	T _{OP}	-20	70	°C
STORAGE TEMPERATURE	T _{STG}	-30	80	°C



HDA430-3

Dimensional Drawing

4.3" ,480x272 ,TFT ,Transmissive Color, Landscape , White LED Backlight

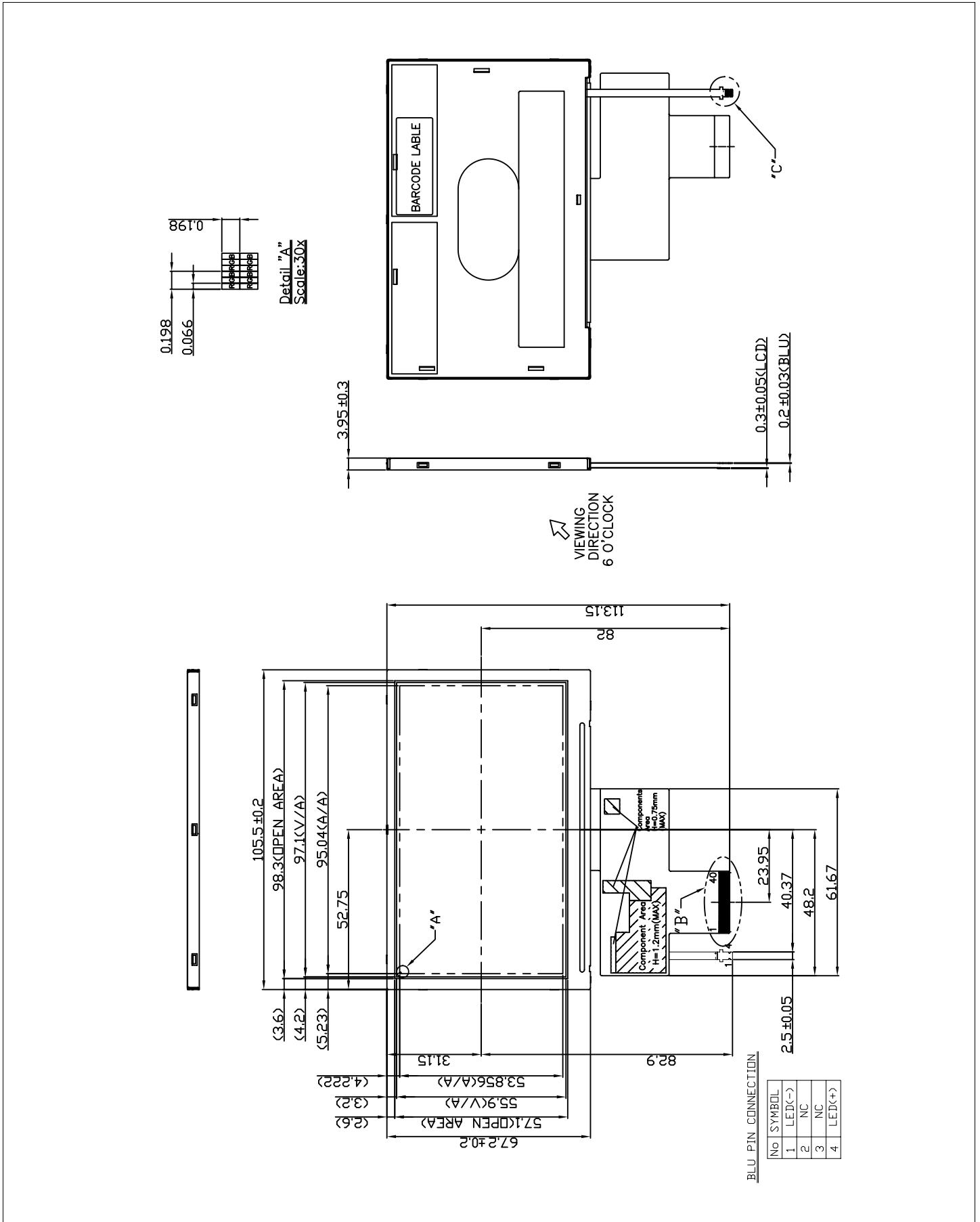

BLU PIN CONNECTION

No	SYMBOL
1	LED(-)
2	NC
3	NC
4	LED(+)



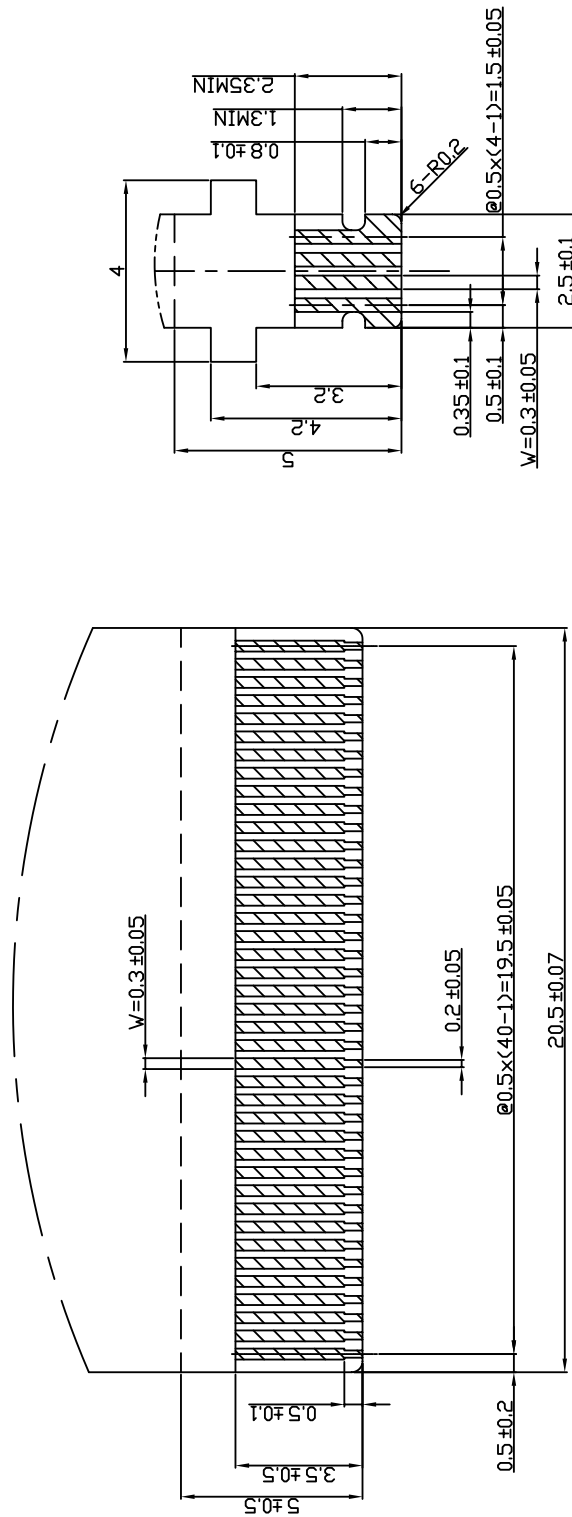

Detail "C"
Scale: 10x

Detail "B"
Scale: 8x

HDA430T-3

Dimensional Drawing

4.3" ,480x272 ,TFT ,with Touch Screen , Landscape , White LED Backlight

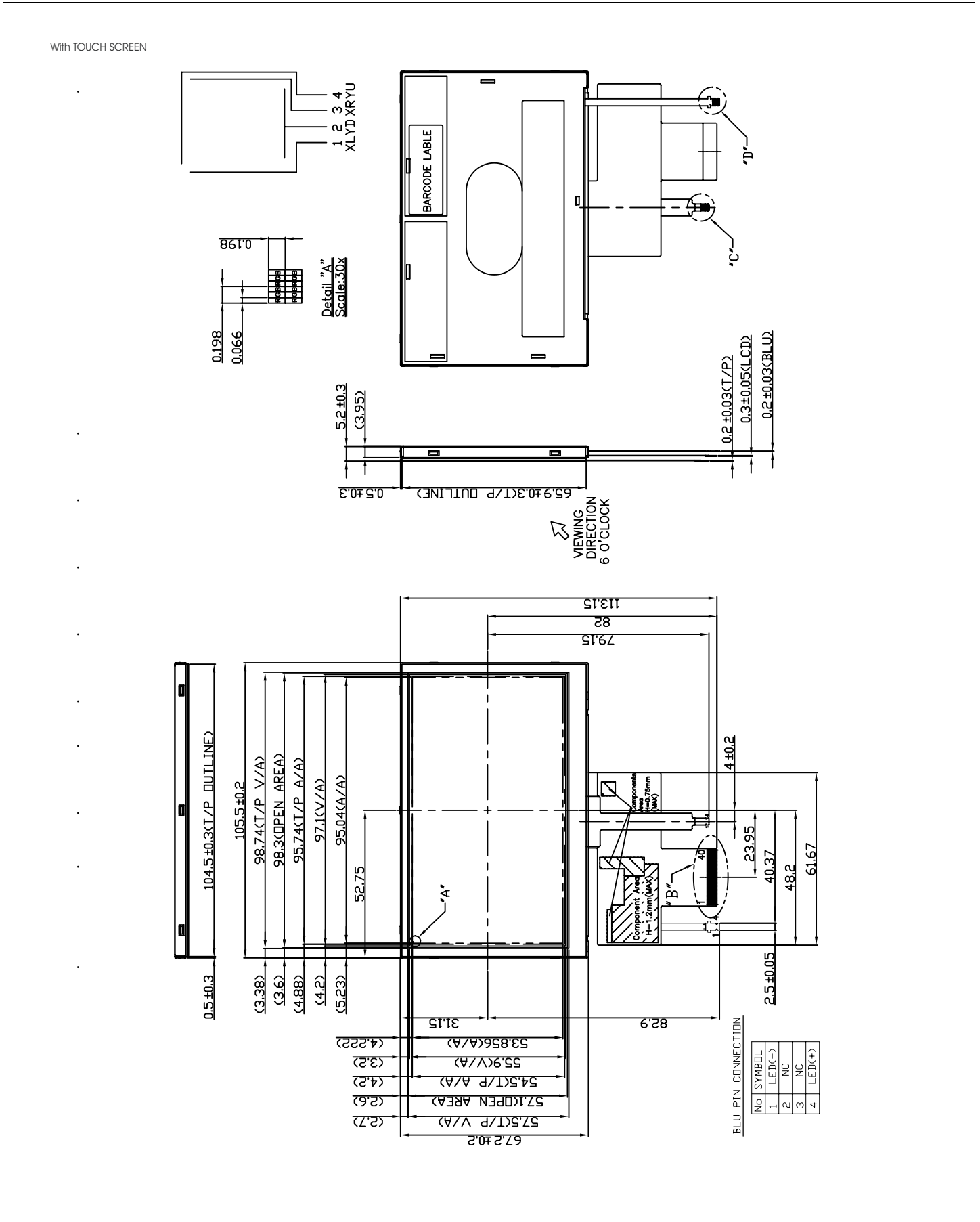

HDA430T-3

Dimensional Drawing

4.3", 480x272, TFT, with Touch Screen, Landscape, White LED Backlight

With TOUCH SCREEN

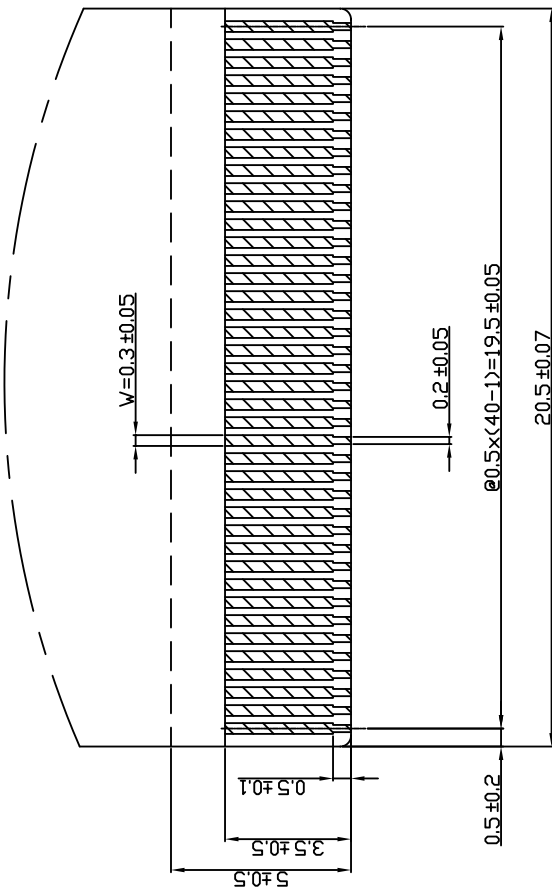
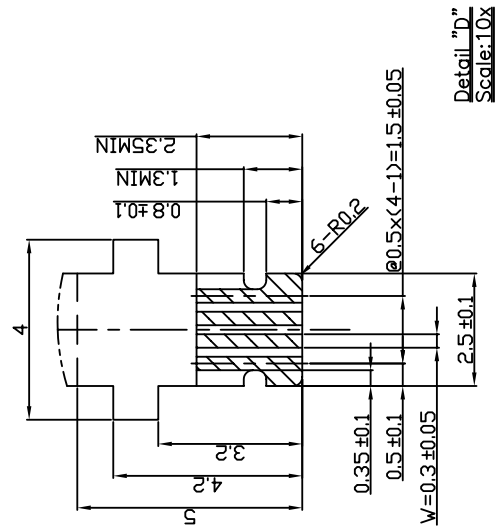
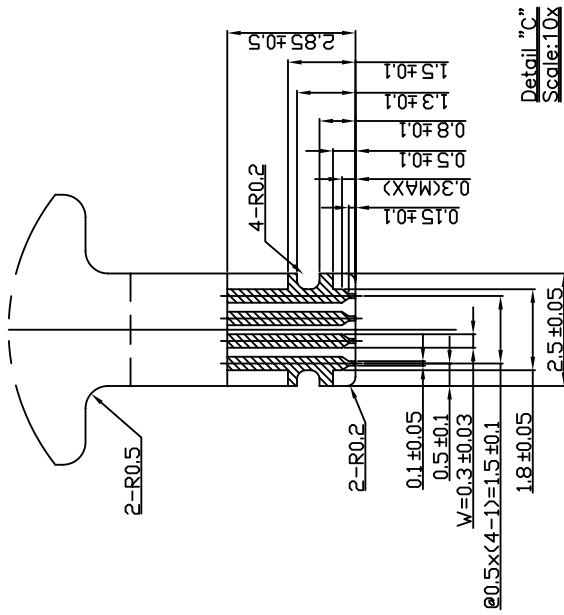

HANTRONIX