

LCD Module Technical Specification

First Edition
August 25, 2008

Final Revision

Type No. **T-55423GD050J-LW-A-ABN**

Customer :

Customer's Product No :

OPTREX CORPORATION

Approved : *Minoru Akatsuka*
QUALITY ASSURANCE DIVISION

Checked : *Noboru Wada*
Module Design G.

Prepared : *Satoshi Sano*
Module Design G.

APPROVED

By _____

Signature :

Date :

Please return this specification within two month with your signature.
If not returned within two month ,specification will be considered
as having been accepted.

CONTENTS

No.	Item	Page
--	CONTENTS	2
1	APPLICATION	3
2	OVERVIEW	4
3	ABSOLUTE MAXIMUM RATINGS	5
4	ELECTRICAL CHARACTERISTICS	5
5	INTERFACE PIN CONNECTION	7
6	INTERFACE TIMING	8
7	BLOCK DIAGRAM	11
8	MECHANICAL SPECIFICATION	12
9	OPTICAL CHARACTERISTICS	14
10	RELIABILITY TEST CONDITION	17
11	INSPECTION STANDARDS	18
12	OTHER FEATURE	19
13	HANDLING PRECAUTIONS FOR TFT-LCD MODULE	19
--	PACKAGING SPECIFICATION	21
--	PRODUCTS NUMBER LABELING FORMS	23

1. APPLICATION

This specification applies to color TFT-LCD module, T-55423GD050J-LW-A-ABN.

These specification papers are the proprietary product of OPTREX and include materials protected under copyright of OPTREX. No part of this document may be reproduced in any form or by any means without the express written permission of OPTREX.

OPTREX does not assume any liability for infringement of patents, copyrights or other intellectual property rights of third parties by or arising from use of a product specified in this document. No license, express, implied or otherwise, is granted under any patents, copyrights or other intellectual property rights of OPTREX or of others.

OPTREX classifies the usage of the TFT-LCD module as follows. Please confirm the usage before using the product.

(1) Standard Usage

Computers, office equipment, factory automation equipment, test and measurement equipment, communications, transportation equipment(automobiles, ships, trains, etc.), provided, however, that operation is not influenced by TFT-LCD directly.

(2) Special Usage

Medical equipment, safety equipment, transportation equipment, provided, however, that TFT-LCD is necessary to its operation.

(3) Specific Usage

Cockpit Equipment, military systems, aerospace equipment, nuclear reactor control systems, life support systems and any other equipment. OPTREX should make a contract that stipulate apportionment of responsibilities between OPTREX and our customer.

The product specified in this document is designed for "Standard Usage" unless otherwise specified in this document. If customers intend to use the product for applications other than those specified for "Standard Usage", they should first contact OPTREX sales representative for it's intended use in writing.

OPTREX has been making continuous effort to improve the reliability of its products. Customers should implement sufficient reliability design of their application equipments such as redundant system design, fail-safe functions, anti-failure features.

OPTREX assumes no responsibility for any damage resulting from the use of the product that does not comply with the instructions and the precautions specified in this document.

Please contact and consult OPTREX sales representative for any questions regarding this product.

T-55423GD050J-LW-A-ABN (AB)	OPTREX CORPORATION	Page 3/23
-----------------------------	--------------------	-----------

OPTREX Confidential

2. OVERVIEW

T-55423GD050J-LW-A-ABN is 5.0" color TFT-LCD (Thin Film Transistor Liquid Crystal Display) module composed of LCD panel, driver ICs, control circuit, and backlight unit.

By applying 8 bit digital data, 800 × 480, 16.7M-color images are displayed on the 5.0" diagonal screen. Input power voltages are 3.3 V and 5.0 V for LCD driving.

The type of data and control signals are digital and transmitted via CMOS interface per Typ. 33.5 MHz clock cycle.

Driver circuit for LED backlight is not included in this module. General specifications are summarized in the following table:

ITEM	SPECIFICATION
Display Area (mm)	108.0(H) × 64.8(V) (5.0-inch diagonal)
Number of Dots	800 × 3 (H) × 480 (V)
Pixel Pitch (mm)	0.135(H) × 0.135 (V)
Color Pixel Arrangement	RGB vertical stripe
Display Mode	Normally black IPS
Number of Color	16.7M
Luminance (cd/m ²)	300
Wide Viewing Angle Technology	IPS
Viewing Angle (CR ≥ 10)	-85~85° (H) -85~85° (V)
Surface Treatment	Clear and hard-coating 2H
Electrical Interface	CMOS
Module Size (mm)	118.5(W) × 77.8(H) × 3.5(D) *)
Module Mass (g)	70
Backlight Unit	Edge-light, LED

*) W/O FPC

Characteristic value without any note is typical value.

T-55423GD050J-LW-A-ABN (AB)	OPTREX CORPORATION	Page 4/23
-----------------------------	--------------------	-----------

OPTREX Confidential

3. ABSOLUTE MAXIMUM RATINGS

ITEM	SYMBOL	MIN.	MAX.	UNIT
Power Supply Voltage for LCD 1	VCC	-0.3	5.0	V
Power Supply Voltage for LCD 2	AVDD	-0.3	5.5	V
Logic Input Voltage	VI	-0.3	5.0	V
Backlight (LED) Current	IF	--	30	mA
Operation Temperature (Panel) <small>Note 1,2)</small>	T _{op(Panel)}	-20	60	°C
Operation Temperature (Ambient) <small>Note 2)</small>	T _{op(Ambient)}	-20	60	°C
Storage Temperature <small>Note 2)</small>	T _{stg}	-30	80	°C

[Note]

1) Measured at the center of active area and at the center of panel back surface

2) Top, Tstg ≤ 40°C : 90%RH max. without condensation

Top, Tstg > 40°C : Absolute humidity shall be less than the value of 90%RH at 40°C without condensation.

4. ELECTRICAL CHARACTERISTICS

(1) TFT-LCD

Ambient temperature: Ta = 25°C

ITEM	SYMBOL	MIN.	TYP.	MAX.	UNIT	Remarks
Power Supply Voltage for LCD 1	VCC	3.0	3.3	3.6	V	*1)
Power Supply Voltage for LCD 2	AVDD	4.8	5.0	5.2	V	*1)
Power Supply Current for LCD 1	ICC	--	7.4	17.0	mA	*2)
Power Supply Current for LCD 2	AIDD	--	38.0	62.0	mA	*2)
Permissive Input Ripple Voltage	VRP	--	--	100	mVp-p	VCC = +3.3V AVDD = +5.0V
Logic Input Voltage	High	VIH	0.7VCC	--	VCC	V
	Low	VIL	0	--	0.3VCC	V

*1) Power and signals sequence:

$$\begin{aligned}
 t1 &\leq 10 \text{ ms} & 160 \text{ ms} &\leq t6 \\
 0 < t2 &\leq 50 \text{ ms} & 160 \text{ ms} &\leq t7 \\
 0 < t3 &\leq 50 \text{ ms} & 0 \text{ ms} &\leq t8 \\
 t4 &\leq 10 \text{ ms} & 1 \text{ s} &\leq t9 \\
 0 < t5 &\leq 50 \text{ ms} & &
 \end{aligned}$$

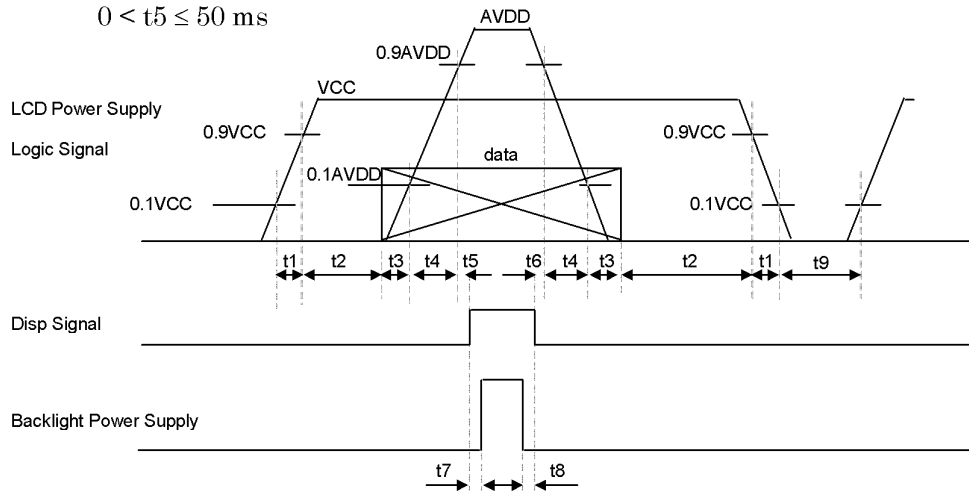

data: RGB DATA, DCLK, DENA, SC

T-55423GD050J-LW-A-ABN (AB)	OPTREX CORPORATION	Page 5/23
-----------------------------	--------------------	-----------

OPTREX Confidential

*2) VCC = + 3.3 V, AVDD=+5.0V, f_H=31.5kHz, f_V=60Hz, f_{CLK}= 33.5MHz

Display image at typical power supply current value is 256-gray-bar pattern (8 bit), 480 line mode.

(2) Backlight

ITEM	SYMBOL	MIN.	TYP.	MAX.	UNIT	Remarks
LED Voltage	VF	(21.0)	--	23.1	V	IF = 20 mA, Ta = 25°C
		--	--	23.8	V	IF = 20 mA, Ta = 0°C
		--	--	24.5	V	IF = 20 mA, Ta = -20°C
LED Current	IF	--	15.0	20.0	mA	*1), *2)

[Note]

*1) Constant Current Drive

*2) LED Current measurement method

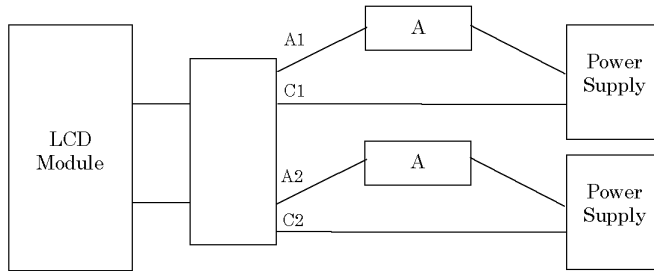

Diode IF-Ta CHARACTERISTICS DIAGRAM

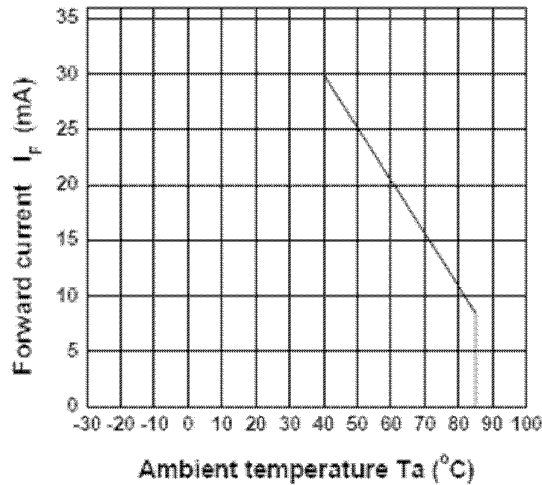

5. INTERFACE PIN CONNECTION

FPC1 (Interface Signal)

Pin No.	Symbol	Function
1	GND	
2	GND	
3	VCC	3.3 V Power Supply
4	VCC	3.3 V Power Supply
5	R0	Red data signal(LSB)
6	R1	Red data signal
7	R2	Red data signal
8	R3	Red data signal
9	R4	Red data signal
10	R5	Red data signal
11	R6	Red data signal
12	R7	Red data signal(MSB)
13	G0	Green data signal(LSB)
14	G1	Green data signal
15	G2	Green data signal
16	G3	Green data signal
17	G4	Green data signal
18	G5	Green data signal
19	G6	Green data signal
20	G7	Green data signal(MSB)
21	B0	Blue data signal(LSB)
22	B1	Blue data signal
23	B2	Blue data signal
24	B3	Blue data signal
25	B4	Blue data signal
26	B5	Blue data signal
27	B6	Blue data signal
28	B7	Blue data signal(MSB)
29	GND	
30	DCLK	Clock signal for sampling catch data signal
31	DISP	Display on/off (High: on, Low: off)
32	HD	Horizontal sync signal
33	VD	Vertical sync signal
34	DENA	Data enable signal (to settle the viewing area)
35	AVDD	5.0 V Analog Power Supply
36	AVDD	5.0 V Analog Power Supply
37	NC	This pin should be open.
38	NC	This pin should be open.
39	SC	Scan direction control (Low= Reverse, High= Normal)
40	GND	
41	GND	
42	LED_C1	LED cathode 1
43	LED_A1	LED anode 1
44	LED_C2	LED cathode 2
45	LED_A2	LED anode 2

*) Metal frame is connected to signal GND.

T-55423GD050J-LW-A-ABN (AB)	OPTREX CORPORATION	Page 7/23
-----------------------------	--------------------	-----------

OPTREX Confidential

6. INTERFACE TIMING

(1) Timing Specifications

ITEM		SYMBOL	MIN.	TYP.	MAX.	UNIT
DCLK	Frequency	f _{CLK}	--	33.5	45	MHz
	Period	t _{CLK}	22.2	29.9	--	ns
	Low Width	tw _{CL}	40%	--	--	t _{CLK}
	High Width	tw _{CH}	40%	--	--	t _{CLK}
DATA(R,G,B), DENA	Set up time	t _{DS}	4	--	--	ns
	Hold time	t _{DH}	2	--	--	ns
DENA	Horizontal Active Time	t _{HA}	800	800	800	t _{CLK}
	Horizontal Blank Time	t _{HB}	164	256	348	t _{CLK}
	Horizontal Front Porch	t _{HFP}	48	167	343	t _{CLK}
	Horizontal Back Porch	t _{HBP}	5	89	116	t _{CLK}
	Vertical Active Time	t _{VA}	480	480	480	t _H
	Vertical Blank Time	t _{VB}	35	45	55	t _H
	Vertical Front Porch	t _{VFP}	2	12	22	t _H
	Vertical Back Porch	t _{VBP}	33	33	33	t _H
HD	Frequency	f _H	--	31.5	35	kHz
	Period	t _H	28.6	31.7	--	μs
	Low Width	tw _{HL}	1	--	--	t _{CLK}
	Set up time	T _{hst}	6	--	--	ns
	Hold time	T _{hhd}	6	--	--	ns
VD	Frequency	f _V	55	60	68	Hz
	Period	t _V	14.7	16.7	18.2	ms
	Low Width	tw _{VL}	1	--	--	t _H
	Set up time	T _{vst}	6	--	--	ns
	Hold time	T _{vhd}	6	--	--	ns

[Note]

- 1) DATA is latched at fall edge of DCLK in this specification.
- 2) Polarities of HD and VD are negative in this specification.
- 3) DENA (Data Enable) should always be positive polarity as shown in the timing specification.
- 4) DCLK should appear during all invalid period, and HD should appear during invalid period of frame cycle.
- 5) Please satisfy following condition.

$$t_{VBn} = t_{VBn-1}$$

T-55423GD050J-LW-A-ABN (AB)	OPTREX CORPORATION	Page 8/23
-----------------------------	--------------------	-----------

OPTREX Confidential

(2) Timing Chart

a. Pixel Timing Chart

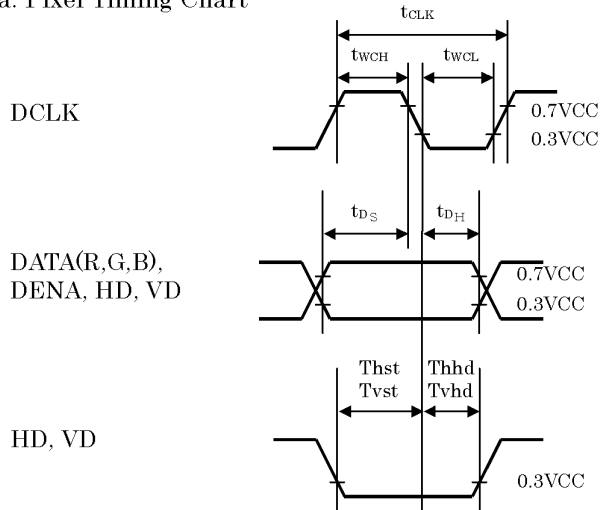

b. Horizontal Timing Chart

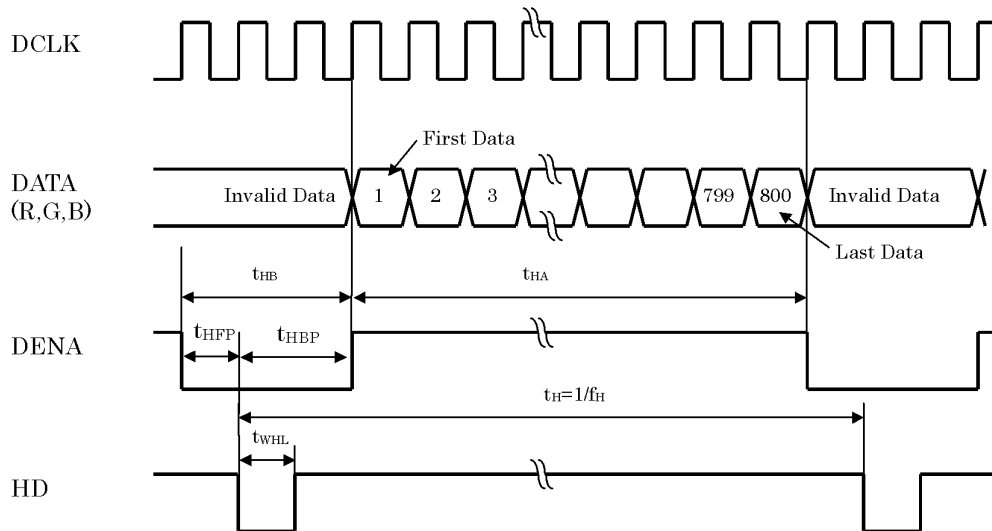

c. Vertical Timing Chart

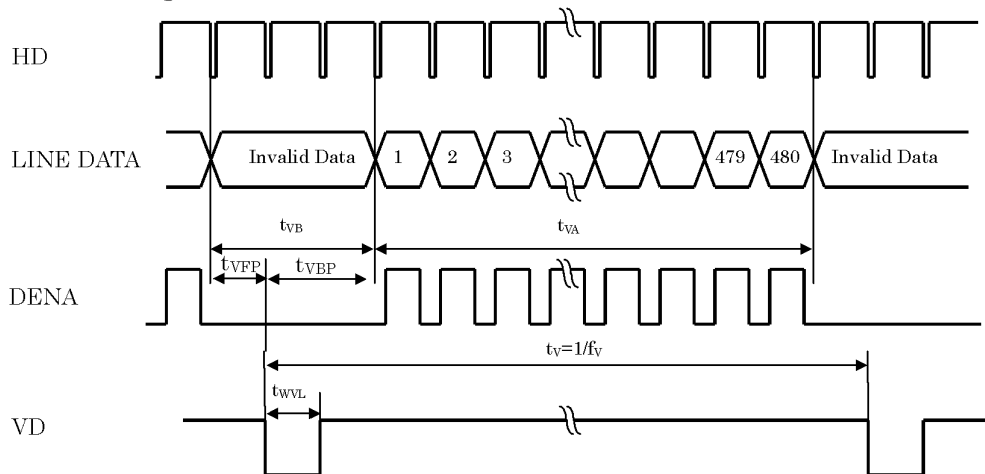

(3) Color Data Assignment

COLOR		INPUT DATA																							
		R DATA								G DATA								B DATA							
		R7	R6	R5	R4	R3	R2	R1	R0	G7	G6	G5	G4	G3	G2	G1	G0	B7	B6	B5	B4	B3	B2	B1	B0
		MSB				LSB				MSB				LSB				MSB				LSB			
BASIC COLOR	BLACK	0	0	0	0	0	0	0	0	0	0	0	0	0	0	0	0	0	0	0	0	0	0	0	0
	RED(255)	1	1	1	1	1	1	1	1	0	0	0	0	0	0	0	0	0	0	0	0	0	0	0	0
	GREEN(255)	0	0	0	0	0	0	0	0	1	1	1	1	1	1	1	1	0	0	0	0	0	0	0	0
	BLUE(255)	0	0	0	0	0	0	0	0	0	0	0	0	0	0	0	0	1	1	1	1	1	1	1	1
	CYAN	0	0	0	0	0	0	0	0	1	1	1	1	1	1	1	1	1	1	1	1	1	1	1	1
	MAGENTA	1	1	1	1	1	1	1	1	0	0	0	0	0	0	0	0	1	1	1	1	1	1	1	1
	YELLOW	1	1	1	1	1	1	1	1	1	1	1	1	1	1	1	1	0	0	0	0	0	0	0	0
	WHITE	1	1	1	1	1	1	1	1	1	1	1	1	1	1	1	1	1	1	1	1	1	1	1	1
RED	RED(1)	0	0	0	0	0	0	0	1	0	0	0	0	0	0	0	0	0	0	0	0	0	0	0	0
	RED(2)	0	0	0	0	0	0	1	0	0	0	0	0	0	0	0	0	0	0	0	0	0	0	0	0
	RED(255)	1	1	1	1	1	1	1	1	0	0	0	0	0	0	0	0	0	0	0	0	0	0	0	0
GREEN	GREEN(1)	0	0	0	0	0	0	0	0	0	0	0	0	0	0	1	0	0	0	0	0	0	0	0	
	GREEN(2)	0	0	0	0	0	0	0	0	0	0	0	0	0	0	1	0	0	0	0	0	0	0	0	
	GREEN(255)	0	0	0	0	0	0	0	0	1	1	1	1	1	1	1	1	0	0	0	0	0	0	0	
BLUE	BLUE(1)	0	0	0	0	0	0	0	0	0	0	0	0	0	0	0	0	0	0	0	0	0	0	0	1
	BLUE(2)	0	0	0	0	0	0	0	0	0	0	0	0	0	0	0	0	0	0	0	0	0	0	1	0
	BLUE(255)	0	0	0	0	0	0	0	0	0	0	0	0	0	0	0	0	1	1	1	1	1	1	1	1

[Note]

- 1) Definition of gray scale
 Color (n) --- n indicates gray scale level.
 Higher n means brighter level.
- 2) Data
 1:High, 0: Low

(4) Display Position and Scan Direction

D(X,Y) shows the data number of input signal for LCD panel signal processing PCB.

SC: High

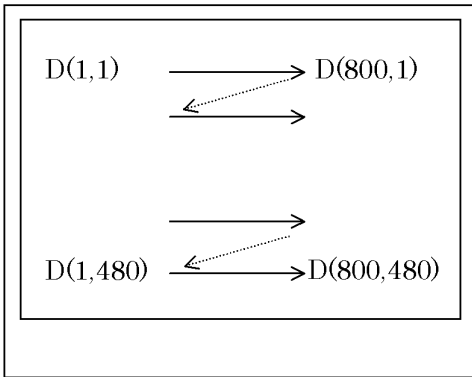

SC: Low

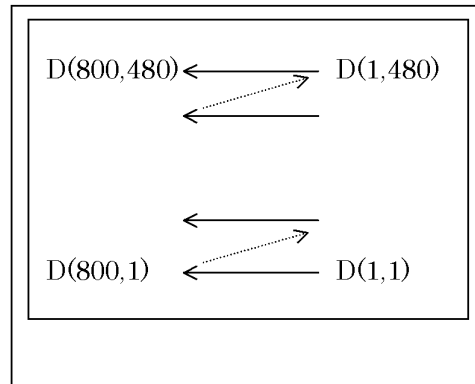

7. BLOCK DIAGRAM

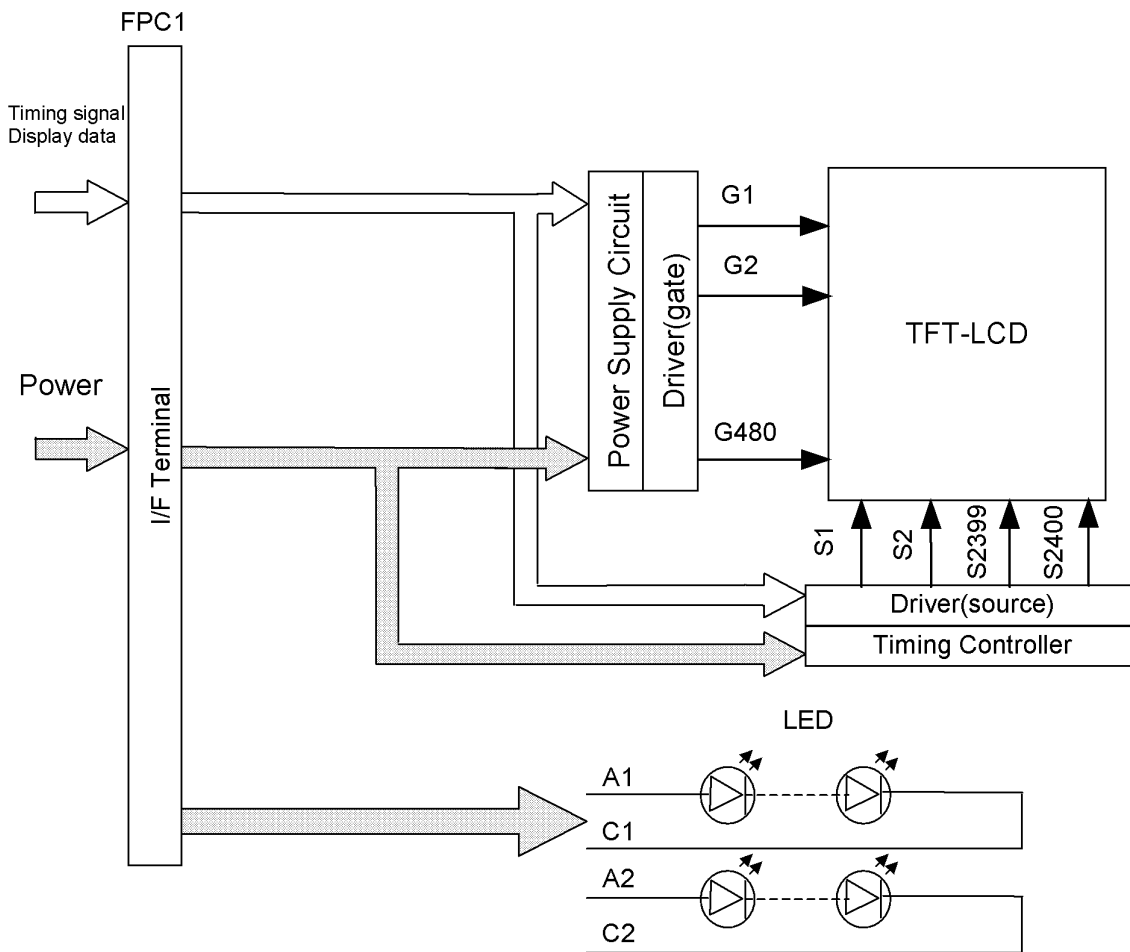

8. MECHANICAL SPECIFICATIONS

(1) Outline Dimensions

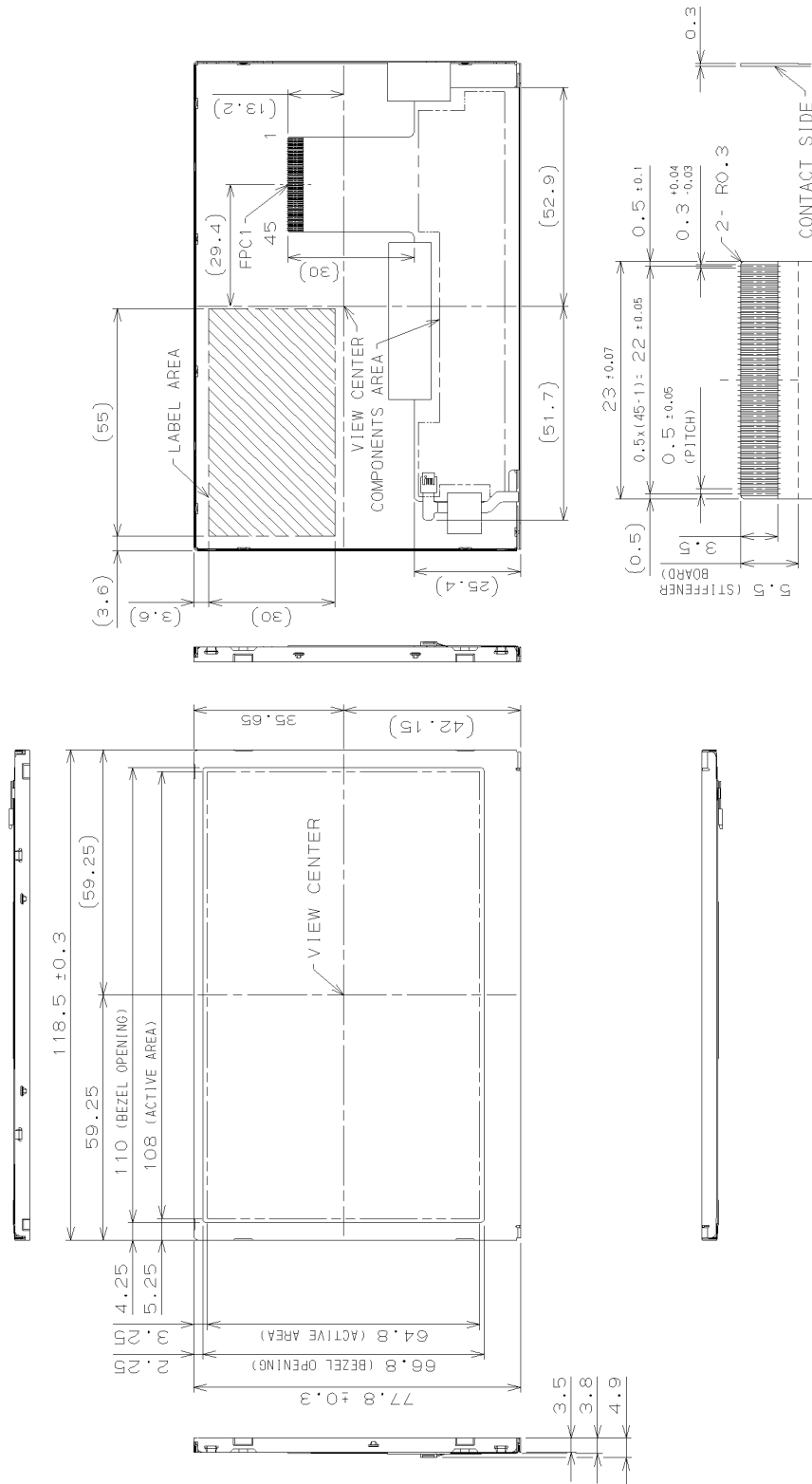

FPC1 corresponding connector: 51296-4594 (MOLEX)

1) Tolerance is ±0.5mm unless noted
 2) Third angle projection

(Unit:mm)

T-55423GD050J-LW-A-ABN (AB)	OPTREX CORPORATION	Page 12/23
-----------------------------	--------------------	------------

(2) Recommended Holding Area

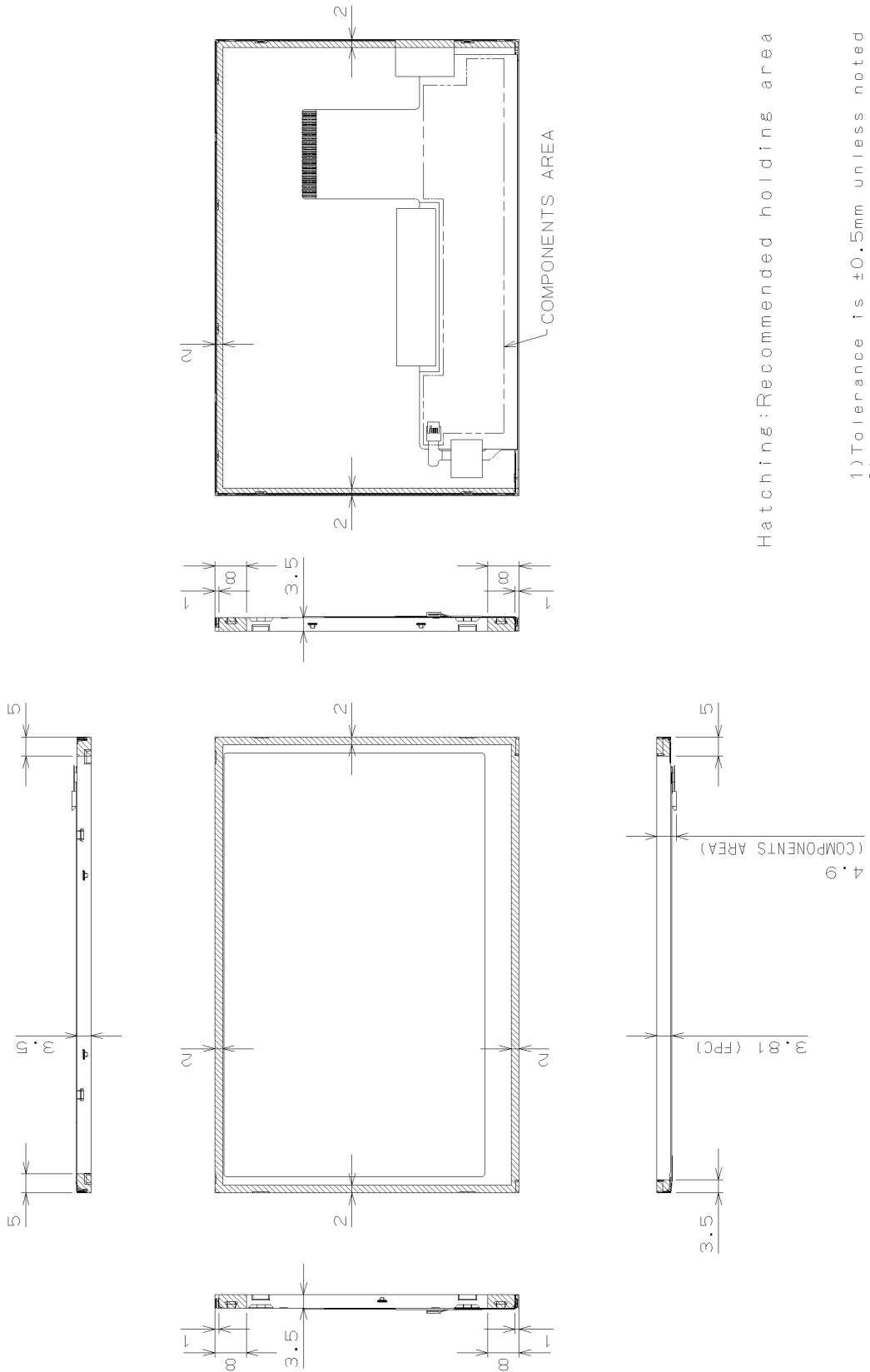

(Unit:mm)

T-55423GD050J-LW-A-ABN (AB)	OPTREX CORPORATION	Page 13/23
-----------------------------	--------------------	------------

9. OPTICAL CHARACTERISTICS

Ta=25°C, VCC=3.3V, AVDD=5.0V, Input Signals: Typ. Values shown in Section 6

ITEM	SYMBOL	CONDITION	MIN.	TYP.	MAX.	UNIT	Remarks	
Contrast Ratio	CR	$\theta_V=0^\circ, \theta_H=0^\circ$	390	600	--	--	*1)*2)*5)	
Luminance	Lw	$\theta_V=0^\circ, \theta_H=0^\circ$	240	300	--	cd/m ²	*1)*5)	
Luminance Uniformity	ΔLw	$\theta_V=0^\circ, \theta_H=0^\circ$	--	--	20	%	*1)*3)*5)	
Response Time	tr	$\theta_V=0^\circ, \theta_H=0^\circ$	--	25	--	ms	*1)*4)*5)	
	tf	$\theta_V=0^\circ, \theta_H=0^\circ$	--	25	--	ms	*1)*4)*5)	
Viewing Angle	Horizontal	θ_H	CR ≥ 10	-70~70	-85~85	--	°	*1)*5)
	Vertical	θ_V		-70~70	-85~85	--	°	*1)*5)
Image Sticking	tis	2 h	--	--	2	s	*6)	
Color Coordinates	Red	Rx	$\theta_V=0^\circ, \theta_H=0^\circ$	0.544	0.594	0.644	--	*1)*5)
		Ry		0.315	0.365	0.415		
	Green	Gx		0.288	0.338	0.388		
		Gy		0.532	0.582	0.632		
	Blue	Bx		0.103	0.153	0.203		
		By		0.072	0.122	0.172		
White	Wx	0.261	0.311	0.361				
	Wy	0.282	0.332	0.382				

[Note]

These items are measured using CS1000(MINOLTA) for color coordinates, EZContrast(ELDIM) for viewing angle and CS1000 or BM-5A(TOPCON) for others under the dark room condition (no ambient light) after more than 30 minutes from turning on the backlight unless noted.

Condition: IF=20 mA(A1), 20 mA(A2)

Measurement method for luminance and color coordinates is as follows.

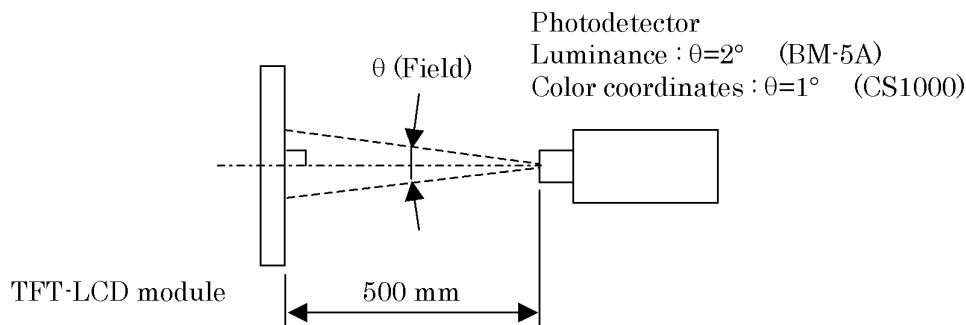

The luminance is measured according to FLAT PANEL DISPLAY MEASUREMENTS STANDARD (VESA Standard).

T-55423GD050J-LW-A-ABN (AB)	OPTREX CORPORATION	Page 14/23
-----------------------------	--------------------	------------

OPTREX Confidential

*1) Measurement Point

Contrast Ratio, Luminance, Response Time, Viewing Angle, Color Coordinates: Display Center
 Luminance Uniformity: point 1~5 shown in a figure below

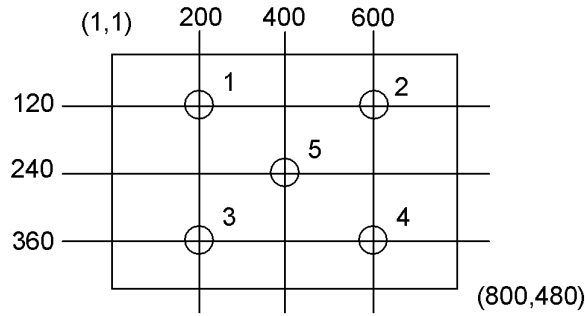

*2) Definition of Contrast Ratio

$CR = \text{Luminance with all white pixels} / \text{Luminance with all black pixels}$

*3) Definition of Luminance Uniformity

$$\Delta L_w = [L_w(\text{MAX}) / L_w(\text{MIN}) - 1] \times 100$$

*4) Definition of Response Time

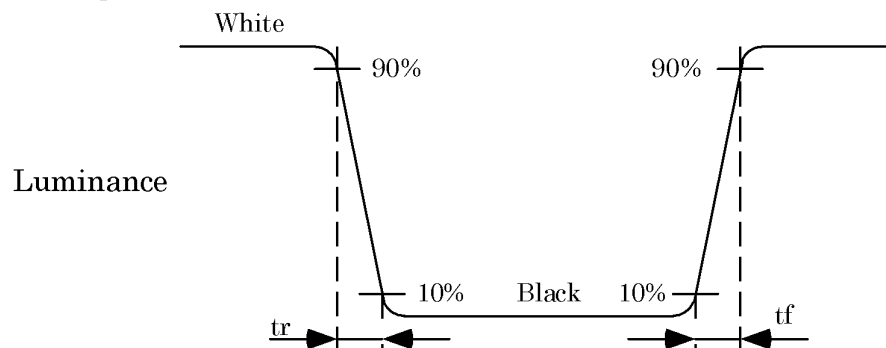

*5) Definition of Viewing Angle (θ_v, θ_H)

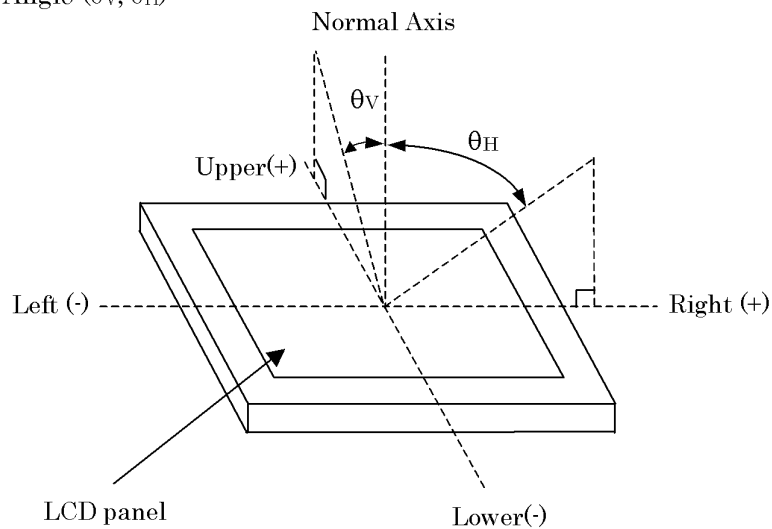

*6) Image Sticking

Continuously display the test pattern shown in the figure below for two-hours. Then display a completely white screen. The previous image shall not persist more than two seconds at 25°C.

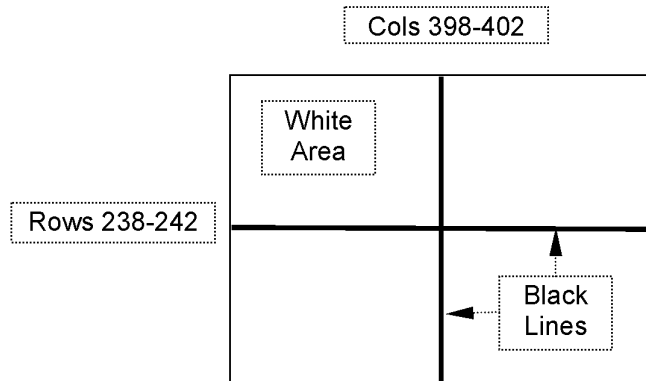

TEST PATTERN FOR IMAGE STICKING TEST

10. RELIABILITY TEST CONDITION

(1) Temperature and Humidity

ITEM	CONDITIONS
HIGH TEMPERATURE HIGH HUMIDITY OPERATION	40°C, 90%RH, 240 h (No condensation)
HIGH TEMPERATURE OPERATION	60°C, 240 h
LOW TEMPERATURE OPERATION	-20°C, 240 h
HIGH TEMPERATURE STORAGE	80°C, 240 h
LOW TEMPERATURE STORAGE	-30°C, 240 h
THERMAL SHOCK (NON-OPERATION)	BETWEEN -30°C (1h) and 80°C(1h), 100 CYCLES

(2) Shock & Vibration

ITEM	CONDITIONS
SHOCK (NON-OPERATION)	Shock level: 1470m/s ² (150G) Waveform: half sinusoidal wave, 2ms Number of shocks: one shock input in each direction of three mutually perpendicular axis for a total of six shock inputs
VIBRATION (NON-OPERATION)	Vibration level: 9.8m/s ² (1.0G) Waveform: sinusoidal Frequency range: 5 to 500Hz Frequency sweep rate: 0.5 octave /min Duration: one sweep from 5 to 500 Hz in each of three mutually perpendicular axis(total 3 hours)

(3) Judgment standard

The judgment of the above tests should be made as follow:

Pass: Normal display image, no damage of the display function. (ex. no line defect)

Partial transformation of the module parts should be ignored.

Fail: No display image, damage of the display function. (ex. line defect)

T-55423GD050J-LW-A-ABN (AB)	OPTREX CORPORATION	Page 17/23
-----------------------------	--------------------	------------

OPTREX Confidential