

Part Number: PDC54-11SRWA SUPER BRIGHT RED

Features

- 0.54 INCH CHARACTER HEIGHT.
- LOW CURRENT OPERATION.
- HIGH CONTRAST AND LIGHT OUTPUT.
- EASY MOUNTING ON P.C. BOARDS OR SOCKETS.
- CATEGORIZED FOR LUMINOUS INTENSITY.
- MECHANICALLY RUGGED.
- STANDARD : GRAY FACE, WHITE SEGMENT.
- RoHS COMPLIANT.

Description

The Super Bright Red source color devices are made with Gallium Aluminum Arsenide Red Light Emitting Diode.

Package Dimensions & Internal Circuit Diagram

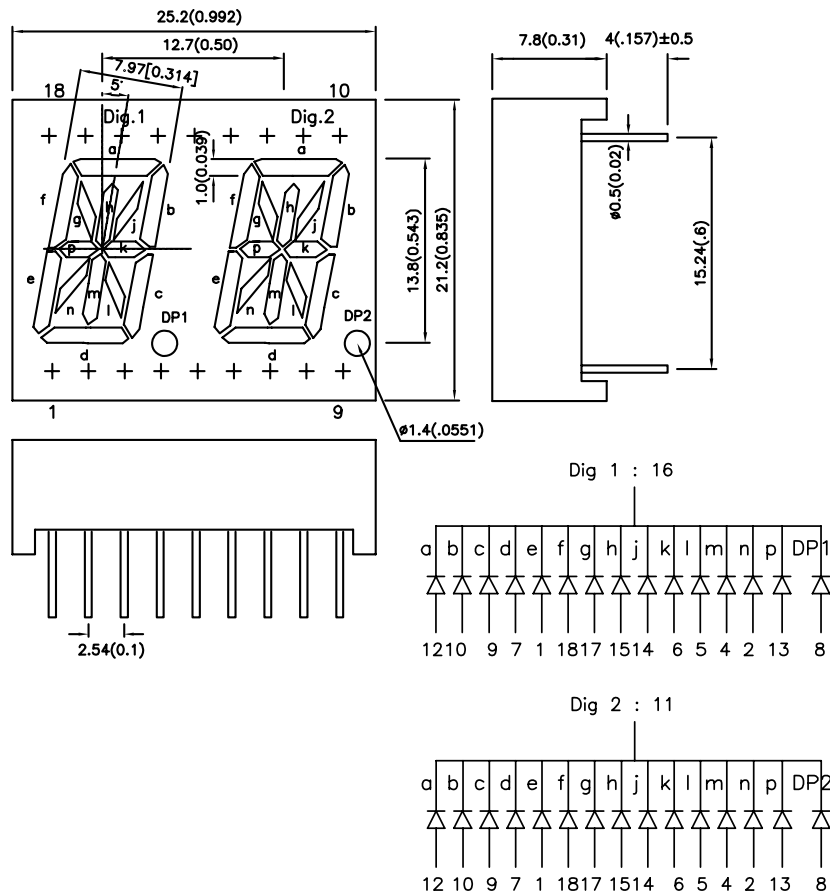

Notes:

1. All dimensions are in millimeters (inches), Tolerance is $\pm 0.25 (0.01)$ unless otherwise noted.
2. Specifications are subject to change without notice.

Selection Guide

| Part No. | Dice | Lens Type | Iv (ucd) [1] @ 10mA | | Description |
|--------------|--------------------------|----------------|------------------------|-------|-----------------------------------|
| | | | Min. | Typ. | |
| PDC54-11SRWA | SUPER BRIGHT RED(GaAlAs) | WHITE DIFFUSED | 4700 | 18000 | Common Cathode ,Rt. Hand Decimal. |

Note:

1. Luminous Intensity/ Luminous Flux: +/-15%.

Electrical / Optical Characteristics at TA=25°C

| Symbol | Parameter | Device | Typ. | Max. | Units | Test Conditions |
|-----------------------|--------------------------|------------------|------|------|-------|-----------------|
| λ_{peak} | Peak Wavelength | Super Bright Red | 660 | | nm | IF=20mA |
| λ_D [1] | Dominant Wavelength | Super Bright Red | 640 | | nm | IF=20mA |
| $\Delta\lambda_{1/2}$ | Spectral Line Half-width | Super Bright Red | 20 | | nm | IF=20mA |
| C | Capacitance | Super Bright Red | 45 | | pF | VF=0V;f=1MHz |
| VF [2] | Forward Voltage | Super Bright Red | 1.85 | 2.5 | V | IF=20mA |
| IR | Reverse Current | Super Bright Red | | 10 | uA | VR = 5V |

Notes:

1. Wavelength: +/-1nm.
2. Forward Voltage: +/-0.1V.

Absolute Maximum Ratings at TA=25°C

| Parameter | Super Bright Red | Units |
|-------------------------------|---------------------|-------|
| Power dissipation | 100 | mW |
| DC Forward Current | 30 | mA |
| Peak Forward Current [1] | 155 | mA |
| Reverse Voltage | 5 | V |
| Operating/Storage Temperature | -40°C To +85°C | |
| Lead Solder Temperature [2] | 260°C For 3 Seconds | |

Notes:

1. 1/10 Duty Cycle, 0.1ms Pulse Width.
2. 2mm below package base.

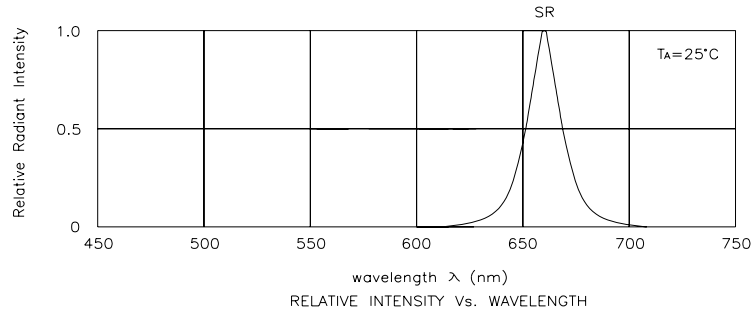

Super Bright Red

PDC54-11SRWA

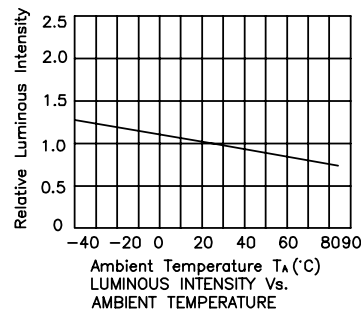
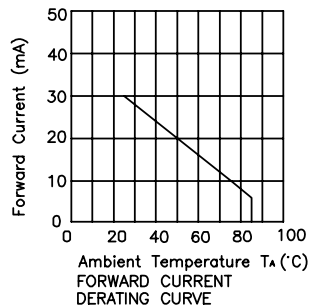
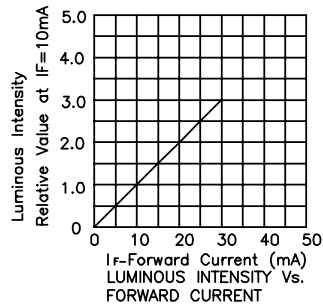
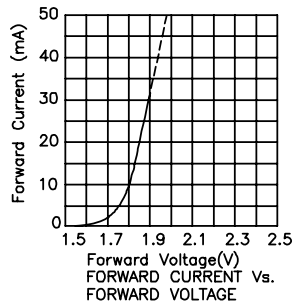

PACKING & LABEL SPECIFICATIONS

PDC54-11SRWA

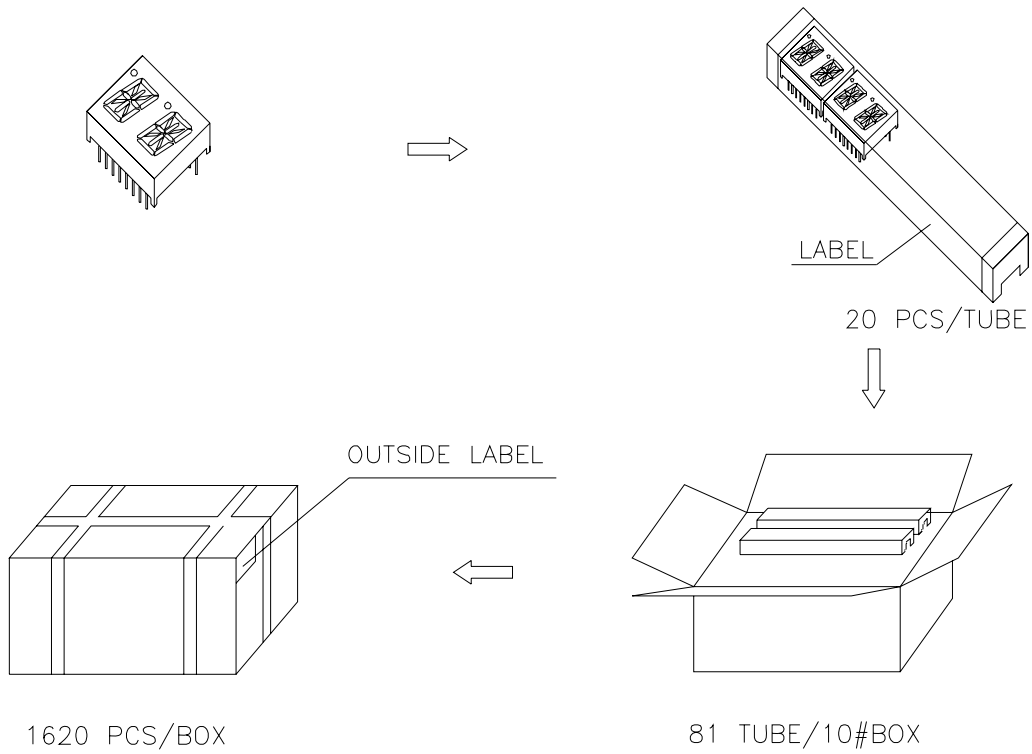

Inside LABEL Paste On The IC-tube

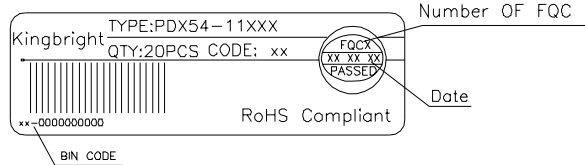

Outside LABEL Paste On The Box

