

IRFHS8342PbF

HEXFET® Power MOSFET

V_{DS}	30	V
$V_{GS\ max}$	±20	V
$R_{DS(on)\ max}$ (@ $V_{GS} = 10V$)	16.0	mΩ
Q_g (typical) (@ $V_{GS} = 4.5V$)	4.2	nC
I_D (@ $T_{c(Bottom)} = 25°C$)	8.5 Ⓣ	A

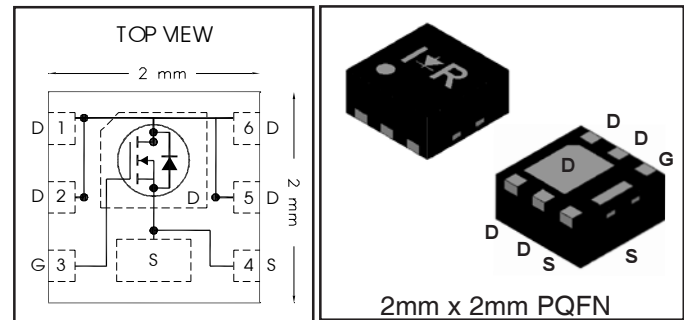

Applications

- Control MOSFET for Buck Converters
- System/Load Switch

Features and Benefits

Features

Low R_{DSon} ($\leq 16.0m\Omega$)
Low Thermal Resistance to PCB ($\leq 13°C/W$)
Low Profile ($\leq 1.0\ mm$)
Compatible with Existing Surface Mount Techniques
RoHS Compliant Containing no Lead, no Bromide and no Halogen
MSL1, Consumer Qualification

results in

Resulting Benefits

Lower Conduction Losses
Enable better thermal dissipation
Increased Power Density
Easier Manufacturing
Environmentally Friendlier
Increased Reliability

Orderable part number	Package Type	Standard Pack		Note
		Form	Quantity	
IRFHS8342TRPBF	PQFN 2mm x 2mm	Tape and Reel	4000	
IRFHS8342TR2PBF	PQFN 2mm x 2mm	Tape and Reel	400	

Absolute Maximum Ratings

	Parameter	Max.	Units
V_{DS}	Drain-to-Source Voltage	30	V
V_{GS}	Gate-to-Source Voltage	±20	
I_D @ $T_A = 25°C$	Continuous Drain Current, V_{GS} @ 10V	8.8Ⓣ	A
I_D @ $T_A = 70°C$	Continuous Drain Current, V_{GS} @ 10V	7.1	
I_D @ $T_{C(Bottom)} = 25°C$	Continuous Drain Current, V_{GS} @ 10V	19Ⓣ	
I_D @ $T_{C(Bottom)} = 70°C$	Continuous Drain Current, V_{GS} @ 10V	15Ⓣ	
I_D @ $T_{C(Bottom)} = 25°C$	Continuous Drain Current, V_{GS} @ 10V (Package Limited)	8.5Ⓣ	
I_{DM}	Pulsed Drain Current ①	76	
P_D @ $T_A = 25°C$	Power Dissipation ④	2.1	W
P_D @ $T_A = 70°C$	Power Dissipation ④	1.3	
	Linear Derating Factor ④	0.02	W/°C
T_J T_{STG}	Operating Junction and Storage Temperature Range	-55 to +150	°C

Notes ① through ⑤ are on page 2

Static @ $T_J = 25^\circ\text{C}$ (unless otherwise specified)

	Parameter	Min.	Typ.	Max.	Units	Conditions
BV_{DSS}	Drain-to-Source Breakdown Voltage	30	—	—	V	$V_{GS} = 0V, I_D = 250\mu A$
$\Delta BV_{DSS}/\Delta T_J$	Breakdown Voltage Temp. Coefficient	—	22	—	mV/°C	Reference to $25^\circ\text{C}, I_D = 1\text{mA}$
$R_{DS(on)}$	Static Drain-to-Source On-Resistance	—	13	16	mΩ	$V_{GS} = 10V, I_D = 8.5A$ ②
		—	20	25		$V_{GS} = 4.5V, I_D = 6.8A$ ③
$V_{GS(th)}$	Gate Threshold Voltage	1.35	1.8	2.35	V	$V_{DS} = V_{GS}, I_D = 25\mu A$
$\Delta V_{GS(th)}$	Gate Threshold Voltage Coefficient	—	-5.8	—	mV/°C	
I_{DSS}	Drain-to-Source Leakage Current	—	—	1.0	μA	$V_{DS} = 24V, V_{GS} = 0V$
		—	—	150		$V_{DS} = 24V, V_{GS} = 0V, T_J = 125^\circ\text{C}$
I_{GSS}	Gate-to-Source Forward Leakage	—	—	100	nA	$V_{GS} = 20V$
	Gate-to-Source Reverse Leakage	—	—	-100		$V_{GS} = -20V$
g_{fs}	Forward Transconductance	18	—	—	S	$V_{DS} = 10V, I_D = 8.5A$ ②
Q_g	Total Gate Charge	—	4.2	—	nC	$V_{GS} = 4.5V, V_{DS} = 15V, I_D = 8.5A$ ②
Q_g	Total Gate Charge	—	8.7	—	nC	$V_{DS} = 15V$
Q_{gs}	Gate-to-Source Charge	—	1.5	—		$V_{GS} = 10V$
Q_{gd}	Gate-to-Drain Charge	—	1.3	—		$I_D = 8.5A$ ② (See Fig. 6 & 16)
R_G	Gate Resistance	—	1.9	—	Ω	
$t_{d(on)}$	Turn-On Delay Time	—	5.9	—	ns	$V_{DD} = 15V, V_{GS} = 4.5V$ ③
t_r	Rise Time	—	15	—		$I_D = 8.5A$ ②
$t_{d(off)}$	Turn-Off Delay Time	—	5.2	—		$R_G = 1.8\Omega$
t_f	Fall Time	—	5.0	—		See Fig.17
C_{iss}	Input Capacitance	—	600	—	pF	$V_{GS} = 0V$
C_{oss}	Output Capacitance	—	100	—		$V_{DS} = 25V$
C_{riss}	Reverse Transfer Capacitance	—	46	—		$f = 1.0\text{MHz}$

Diode Characteristics

	Parameter	Min.	Typ.	Max.	Units	Conditions
I_S	Continuous Source Current (Body Diode)	—	—	8.5 ②	A	MOSFET symbol showing the integral reverse p-n junction diode.
I_{SM}	Pulsed Source Current (Body Diode) ①	—	—	76		
V_{SD}	Diode Forward Voltage	—	—	1.0	V	$T_J = 25^\circ\text{C}, I_S = 8.5A$ ②, $V_{GS} = 0V$ ③
t_{rr}	Reverse Recovery Time	—	11	17	ns	$T_J = 25^\circ\text{C}, I_F = 8.5A$ ②, $V_{DD} = 13V$
Q_{rr}	Reverse Recovery Charge	—	13	20	nC	$di/dt = 330\text{A}/\mu\text{s}$ ③
t_{on}	Forward Turn-On Time	Time is dominated by parasitic Inductance				

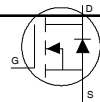

Thermal Resistance

	Parameter	Typ.	Max.	Units
$R_{\theta JC}$ (Bottom)	Junction-to-Case ⑤	—	13	°C/W
$R_{\theta JC}$ (Top)	Junction-to-Case ⑤	—	90	
$R_{\theta JA}$	Junction-to-Ambient ④	—	60	
$R_{\theta JA}$	Junction-to-Ambient (<10s) ④	—	42	

Notes:

- ① Repetitive rating; pulse width limited by max. junction temperature.
- ② Current limited by package.
- ③ Pulse width $\leq 400\mu\text{s}$; duty cycle $\leq 2\%$.
- ④ When mounted on 1 inch square copper board
- ⑤ R_{θ} is measured at T_J of approximately 90°C .

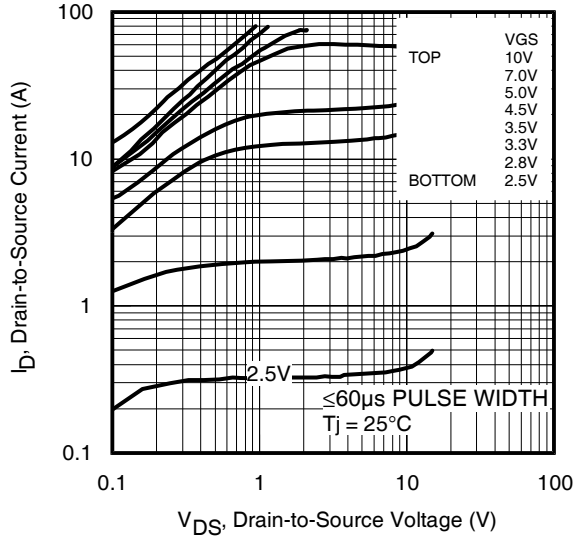

Fig 1. Typical Output Characteristics

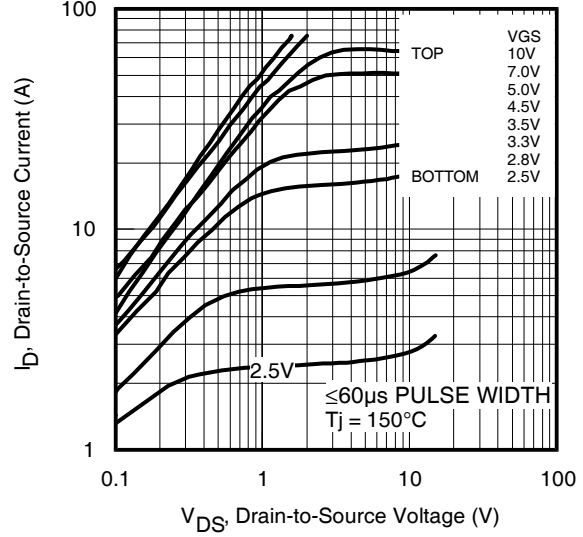

Fig 2. Typical Output Characteristics

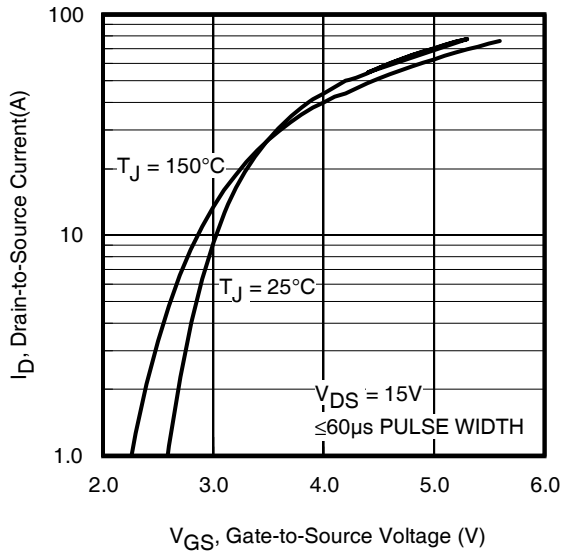

Fig 3. Typical Transfer Characteristics

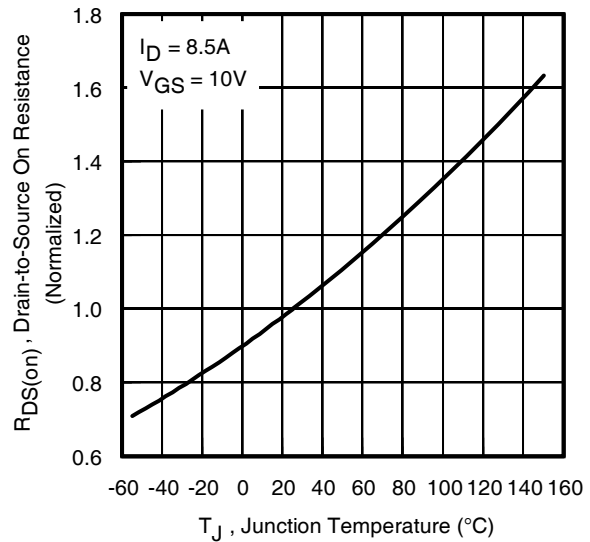

Fig 4. Normalized On-Resistance vs. Temperature

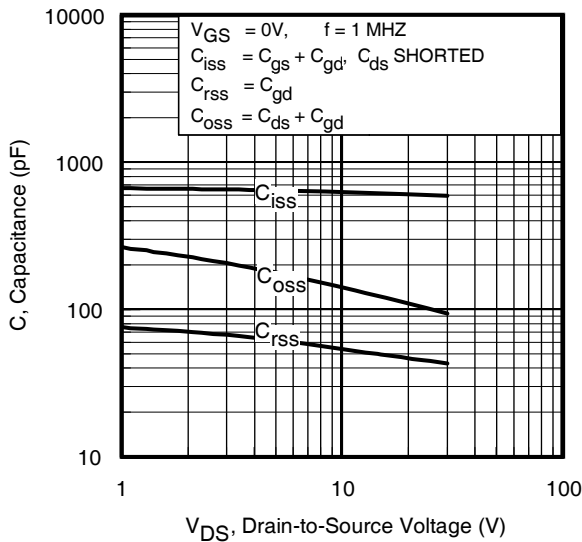

Fig 5. Typical Capacitance vs. Drain-to-Source Voltage
www.irf.com

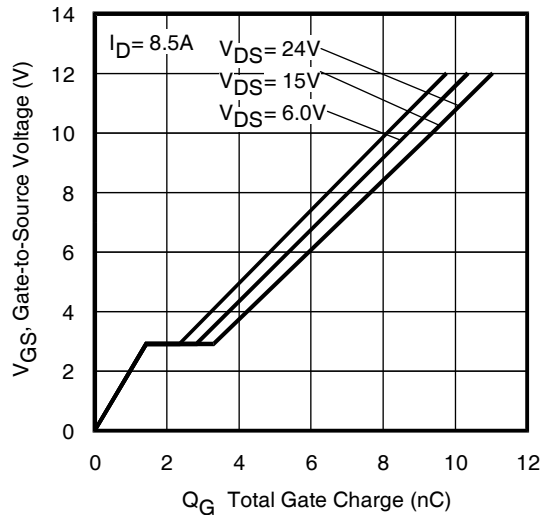

Fig 6. Typical Gate Charge vs. Gate-to-Source Voltage

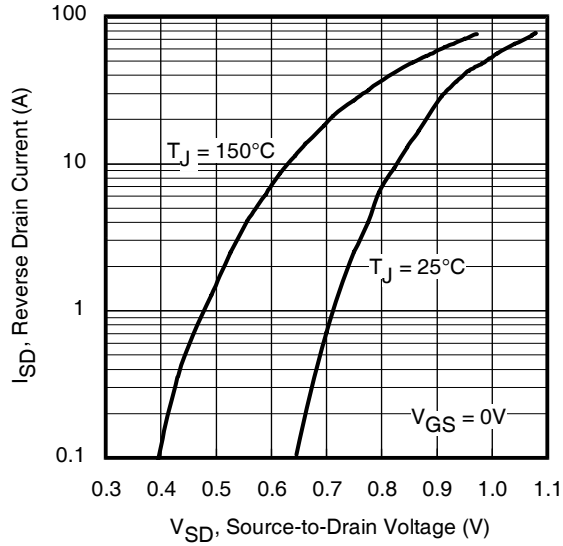

Fig 7. Typical Source-Drain Diode Forward Voltage

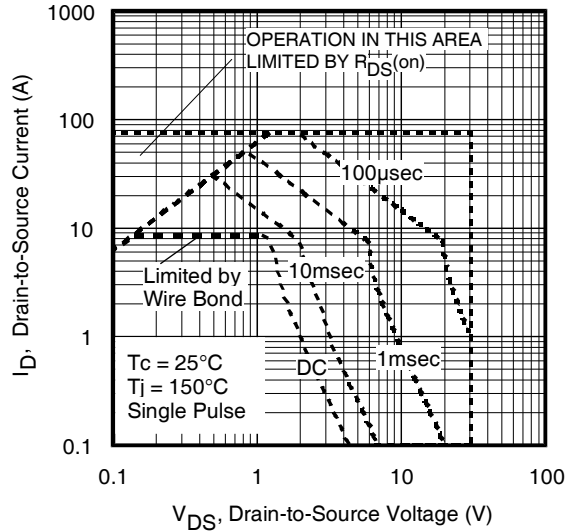

Fig 8. Maximum Safe Operating Area

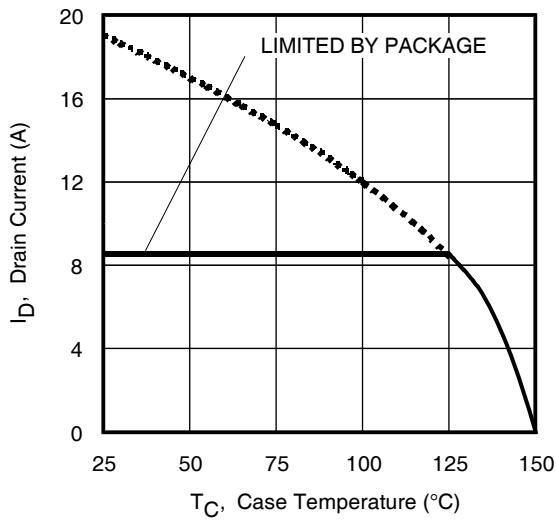

Fig 9. Maximum Drain Current vs. Case (Bottom) Temperature

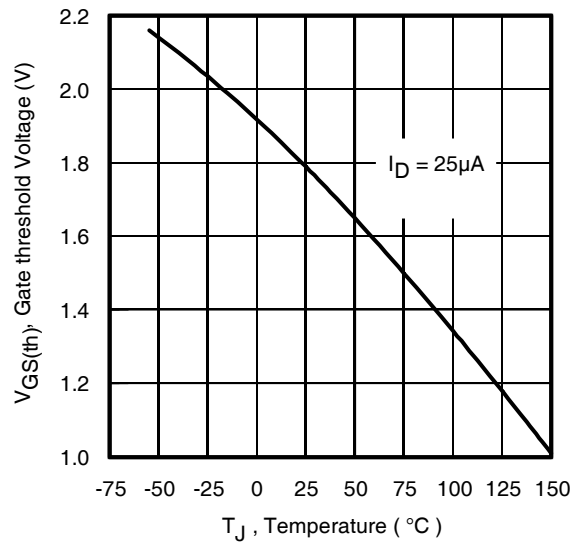

Fig 10. Threshold Voltage vs. Temperature

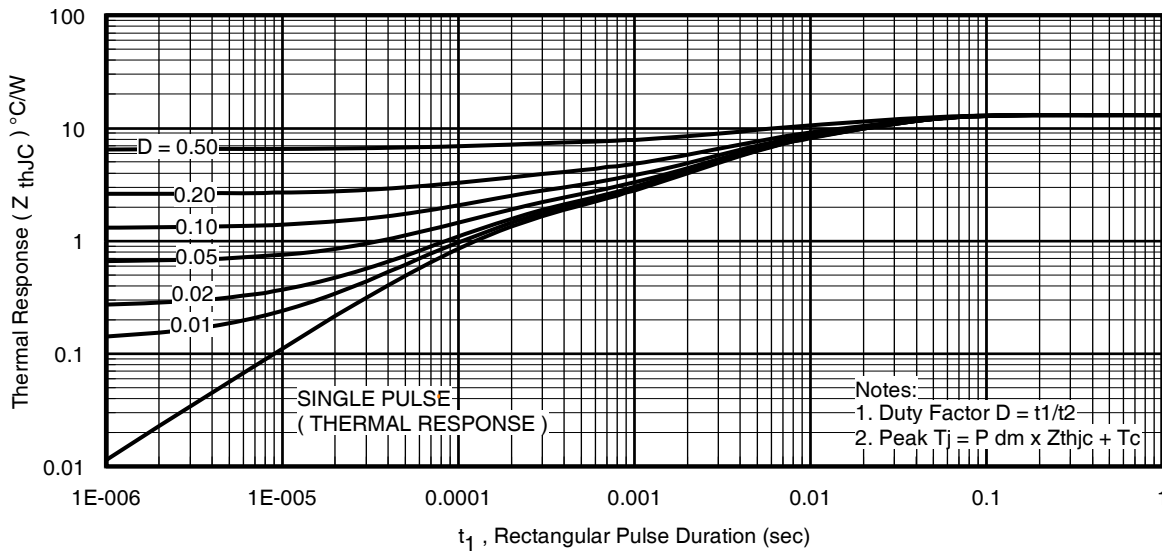

Fig 11. Maximum Effective Transient Thermal Impedance, Junction-to-Case (Bottom)

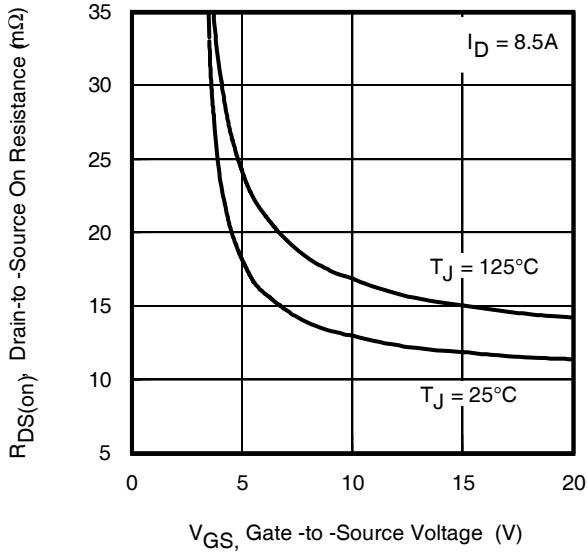

Fig 12. On-Resistance vs. Gate Voltage

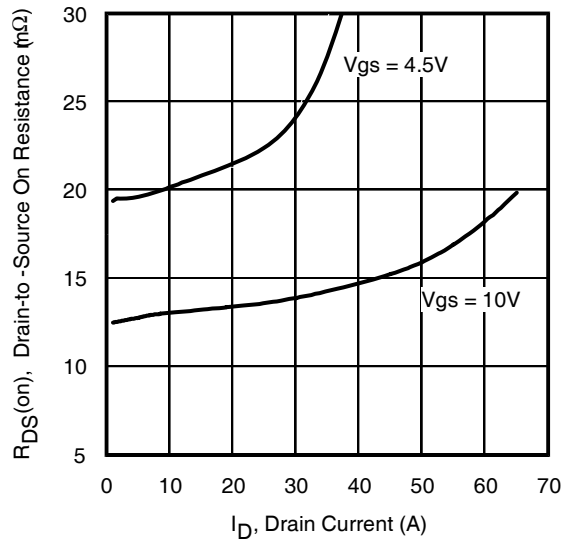

Fig 13. Typical On-Resistance vs. Drain Current

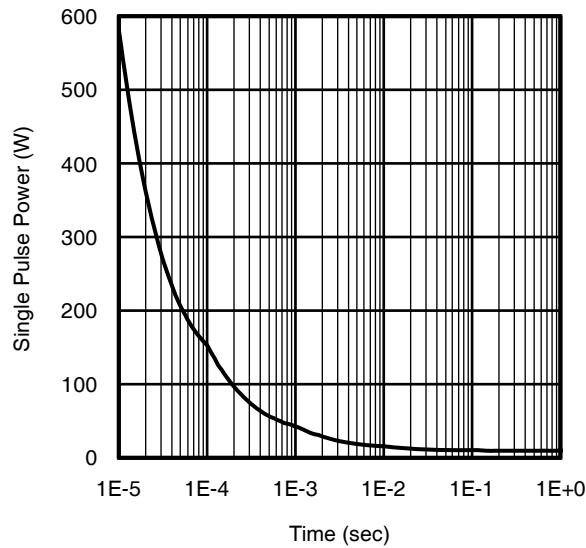

Fig 14. Typical Power vs. Time

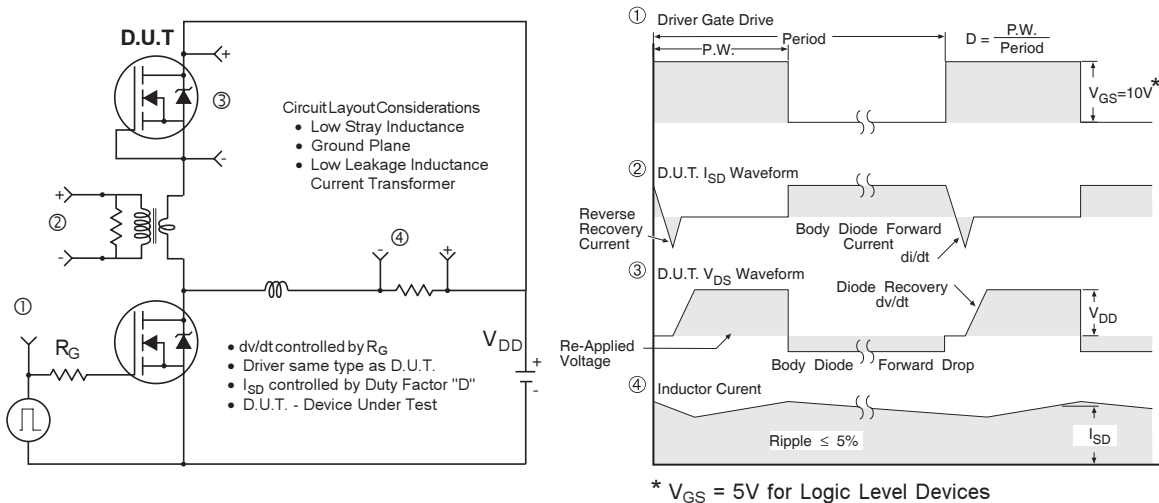

Fig 15. Peak Diode Recovery dv/dt Test Circuit for N-Channel HEXFET® Power MOSFETs

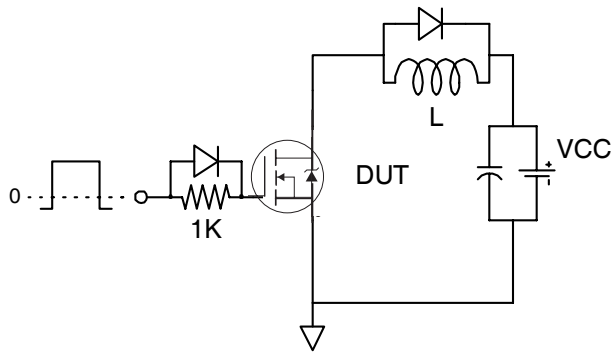

Fig 16a. Gate Charge Test Circuit

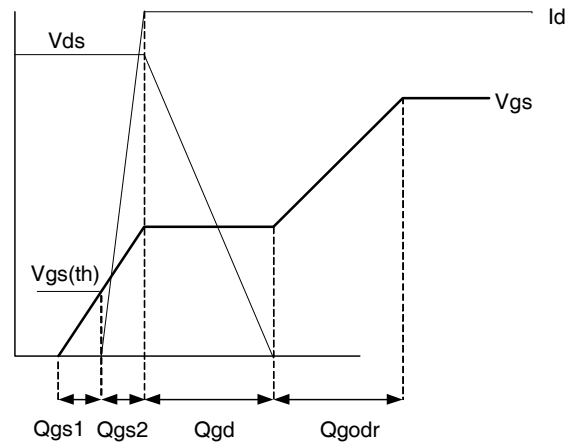

Fig 16b. Gate Charge Waveform

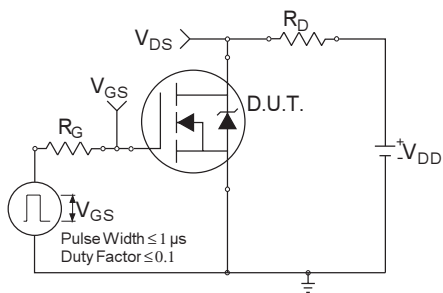

Fig 17a. Switching Time Test Circuit

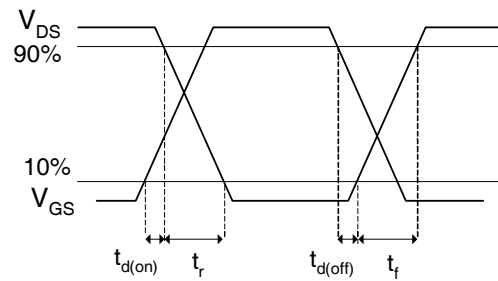
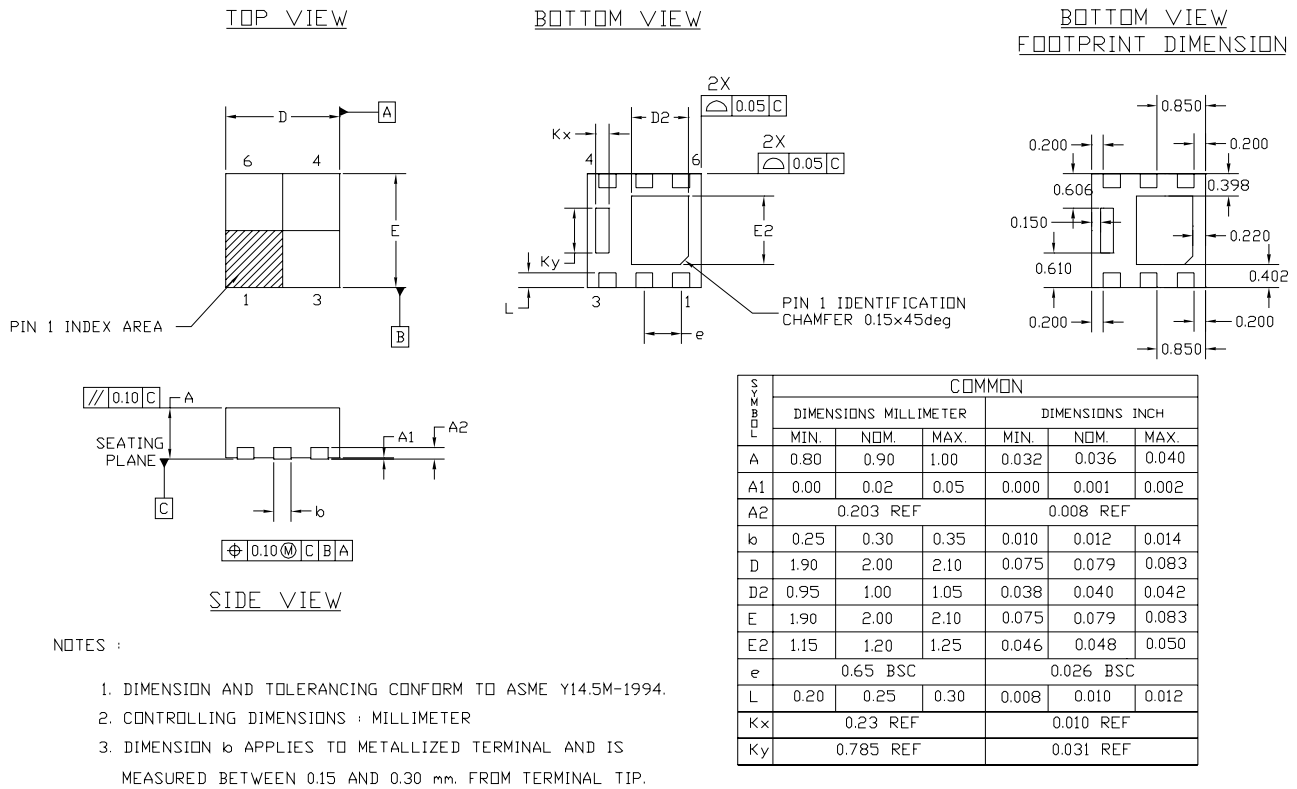

Fig 17b. Switching Time Waveforms

PQFN 2x2 Outline Package Details



For footprint and stencil design recommendations, please refer to application note AN-1154 at <http://www.irf.com/technical-info/appnotes/an-1154.pdf>

PQFN 2x2 Outline Part Marking

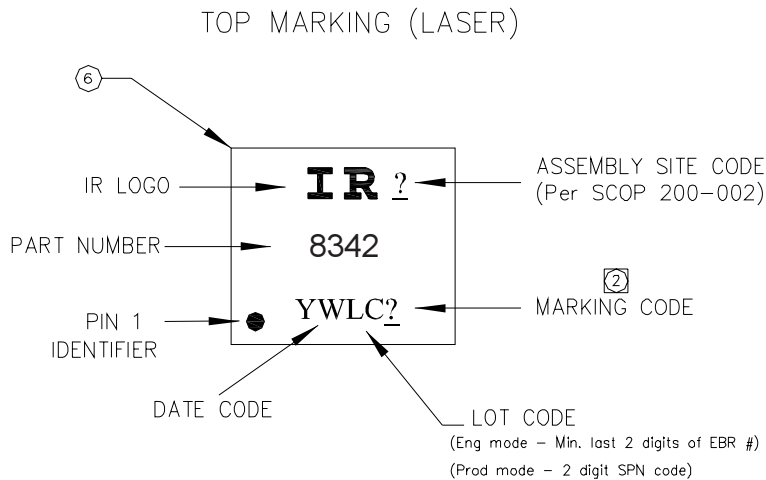

Note: For the most current drawing please refer to IR website at: <http://www.irf.com/package/>
www.irf.com

PQFN 2x2 Outline Tape and Reel

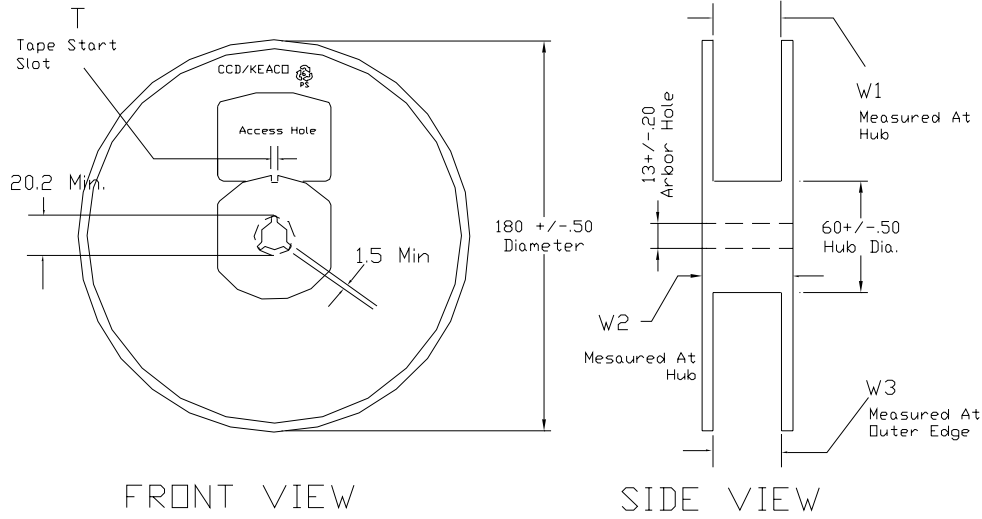
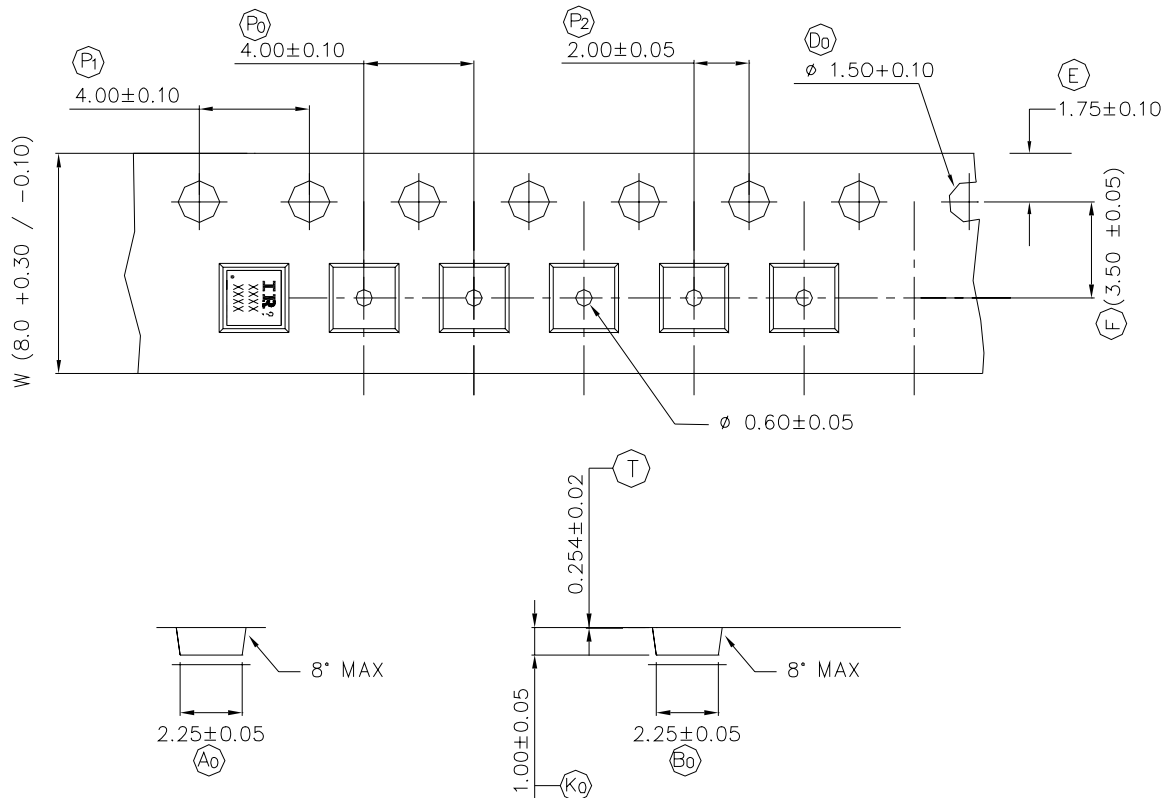

TABLE 1: REEL DETAILS

TAPE WIDTH	T	W1	W2	W3	PART NO
8 MM	3 ± 0.50	8.4 ^{+1.5} _{-0.0}	14.4 Max	7.90 Min 10.9 Max	91586-1
12 MM	5 ± 0.50	12.4 ^{+2.0} _{-0.0}	18.4 Max	11.9 Min 15.4 Max	91586-2

Note: Surface resistivity is $\geq 1 \times 10^5$ but $< 1 \times 10^{12}$ ohm/sq.



Qualification information[†]

Qualification level	Consumer ^{††} (per JEDEC JESD47F ^{†††} guidelines)	
Moisture Sensitivity Level	PQFN 2mm x 2mm	MSL 1 (per JEDEC J-STD-020D ^{†††})
RoHS compliant	Yes	

† Qualification standards can be found at International Rectifier's web site
<http://www.irf.com/product-info/reliability>

†† Higher qualification ratings may be available should the user have such requirements.
 Please contact your International Rectifier sales representative for further information:
<http://www.irf.com/whoto-call/salesrep/>

††† Applicable version of JEDEC standard at the time of product release.

Data and specifications subject to change without notice.

International
IR Rectifier

IR WORLD HEADQUARTERS: 233 Kansas St., El Segundo, California 90245, USA Tel: (310) 252-7105
 TAC Fax: (310) 252-7903

Visit us at www.irf.com for sales contact information.11/2010