

# FDT3N40

## 400V N-Channel MOSFET

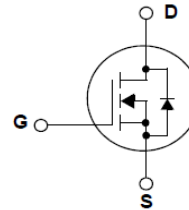
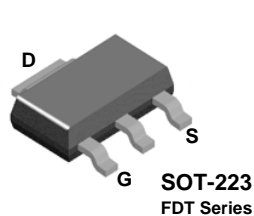
### Features

- 2A, 400V,  $R_{DS(on)} = 3.4\Omega$  @  $V_{GS} = 10\text{ V}$
- Low gate charge ( typical 4.5 nC)
- Low  $C_{rss}$  ( typical 3.7 pF)
- Fast switching
- 100% avalanche tested
- Improved dv/dt capability

### Description

These N-Channel enhancement mode power field effect transistors are produced using Fairchild's proprietary, planar stripe, DMOS technology.

This advanced technology has been especially tailored to minimize on-state resistance, provide superior switching performance, and withstand high energy pulse in the avalanche and commutation mode. These devices are well suited for high efficient switched mode power supplies and active power factor correction.



### Absolute Maximum Ratings

Symbol	Parameter	FDT3N40	Unit
$V_{DSS}$	Drain-Source Voltage	400	V
$I_D$	Drain Current	- Continuous ( $T_C = 25^\circ\text{C}$ )	2.0 *
		- Continuous ( $T_C = 100^\circ\text{C}$ )	1.2 *
$I_{DM}$	Drain Current - Pulsed (Note 1)	8.0 *	A
$V_{GSS}$	Gate-Source voltage	$\pm 30$	V
$E_{AS}$	Single Pulsed Avalanche Energy (Note 2)	46	mJ
$I_{AR}$	Avalanche Current (Note 1)	2	A
$E_{AR}$	Repetitive Avalanche Energy (Note 1)	0.2	mJ
dv/dt	Peak Diode Recovery dv/dt (Note 3)	4.5	V/ns
$P_D$	Power Dissipation ( $T_C = 25^\circ\text{C}$ )	2	W
		0.02	W/ $^\circ\text{C}$
$T_J, T_{STG}$	Operating and Storage Temperature Range	-55 to +150	$^\circ\text{C}$
$T_L$	Maximum Lead Temperature for Soldering Purpose, 1/8" from Case for 5 Seconds	300	$^\circ\text{C}$

\* Drain current limited by maximum junction temperature

### Thermal Characteristics

Symbol	Parameter	Typ	Max	Unit
$R_{\theta JA}$ *	Thermal Resistance, Case-to-Sink Typ.	--	60	$^\circ\text{C/W}$

\* Surface Mounted on JE5D51-3 Board,  $T < 0.1\text{sec}$ .

## Package Marking and Ordering Information

Device Marking	Device	Package	Reel Size	Tape Width	Quantity
FDT3N40	FDT3N40TF	SOT-223	330mm	12mm	4000

## Electrical Characteristics T<sub>C</sub> = 25°C unless otherwise noted

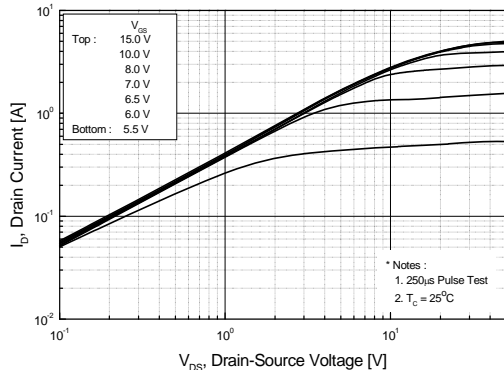
Symbol	Parameter	Conditions	Min.	Typ.	Max	Units
<b>Off Characteristics</b>						
BV <sub>DSS</sub>	Drain-Source Breakdown Voltage	V <sub>GS</sub> = 0V, I <sub>D</sub> = 250μA	400	--	--	V
ΔBV <sub>DSS</sub> / ΔT <sub>J</sub>	Breakdown Voltage Temperature Coefficient	I <sub>D</sub> = 250μA, Referenced to 25°C	--	0.4	--	V/°C
I <sub>DSS</sub>	Zero Gate Voltage Drain Current	V <sub>DS</sub> = 400V, V <sub>GS</sub> = 0V V <sub>DS</sub> = 320V, T <sub>C</sub> = 125°C	--	--	1 10	μA μA
I <sub>GSSF</sub>	Gate-Body Leakage Current, Forward	V <sub>GS</sub> = 30V, V <sub>DS</sub> = 0V	--	--	100	nA
I <sub>GSSR</sub>	Gate-Body Leakage Current, Reverse	V <sub>GS</sub> = -30V, V <sub>DS</sub> = 0V	--	--	-100	nA
<b>On Characteristics</b>						
V <sub>GS(th)</sub>	Gate Threshold Voltage	V <sub>DS</sub> = V <sub>GS</sub> , I <sub>D</sub> = 250μA	3.0	--	5.0	V
R <sub>DS(on)</sub>	Static Drain-Source On-Resistance	V <sub>GS</sub> = 10V, I <sub>D</sub> = 1A	--	2.8	3.4	Ω
g <sub>FS</sub>	Forward Transconductance	V <sub>DS</sub> = 40V, I <sub>D</sub> = 1A (Note 4)	--	2	--	S
<b>Dynamic Characteristics</b>						
C <sub>iss</sub>	Input Capacitance	V <sub>DS</sub> = 25V, V <sub>GS</sub> = 0V, f = 1.0MHz	--	173	225	pF
C <sub>oss</sub>	Output Capacitance		--	30	40	pF
C <sub>rss</sub>	Reverse Transfer Capacitance		--	3.7	6	pF
<b>Switching Characteristics</b>						
t <sub>d(on)</sub>	Turn-On Delay Time	V <sub>DD</sub> = 200V, I <sub>D</sub> = 2A R <sub>G</sub> = 25Ω  (Note 4, 5)	--	10	30	ns
t <sub>r</sub>	Turn-On Rise Time		--	30	70	ns
t <sub>d(off)</sub>	Turn-Off Delay Time		--	10	30	ns
t <sub>f</sub>	Turn-Off Fall Time		--	25	60	ns
Q <sub>g</sub>	Total Gate Charge	V <sub>DS</sub> = 320V, I <sub>D</sub> = 2A V <sub>GS</sub> = 10V  (Note 4, 5)	--	4.5	6	nC
Q <sub>gs</sub>	Gate-Source Charge		--	1.2	--	nC
Q <sub>gd</sub>	Gate-Drain Charge		--	2	--	nC
<b>Drain-Source Diode Characteristics and Maximum Ratings</b>						
I <sub>S</sub>	Maximum Continuous Drain-Source Diode Forward Current		--	--	2	A
I <sub>SM</sub>	Maximum Pulsed Drain-Source Diode Forward Current		--	--	8	A
V <sub>SD</sub>	Drain-Source Diode Forward Voltage	V <sub>GS</sub> = 0V, I <sub>S</sub> = 2A	--	--	1.4	V
t <sub>rr</sub>	Reverse Recovery Time	V <sub>GS</sub> = 0V, I <sub>S</sub> = 2A di <sub>f</sub> /dt = 100A/μs (Note 4)	--	210	--	ns
Q <sub>rr</sub>	Reverse Recovery Charge		--	0.75	--	μC

### NOTES:

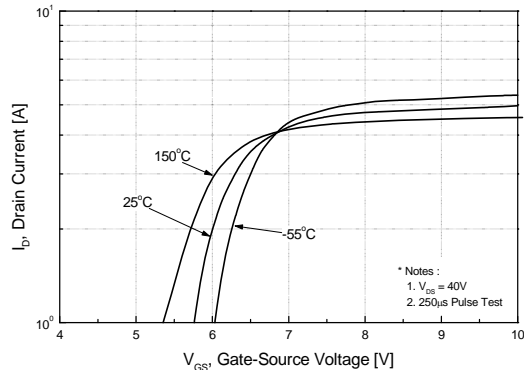
1. Repetitive Rating: Pulse width limited by maximum junction temperature
2. L = 10mH, I<sub>AS</sub> = 2A, V<sub>DD</sub> = 50V, R<sub>G</sub> = 25Ω, Starting T<sub>J</sub> = 25°C
3. I<sub>SD</sub> ≤ 2A, di/dt ≤ 200A/μs, V<sub>DD</sub> ≤ BV<sub>DSS</sub>, Starting T<sub>J</sub> = 25°C
4. Pulse Test: Pulse width ≤ 300μs, Duty Cycle ≤ 2%
5. Essentially Independent of Operating Temperature Typical Characteristics

## Typical Performance Characteristics

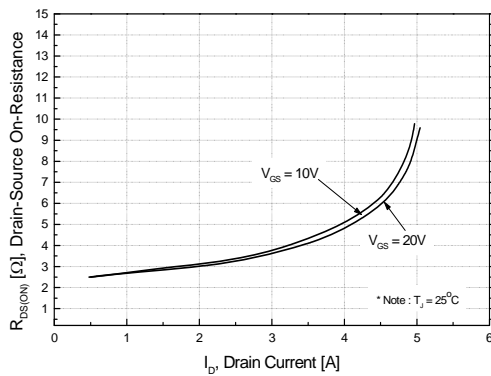
**Figure 1. On-Region Characteristics**



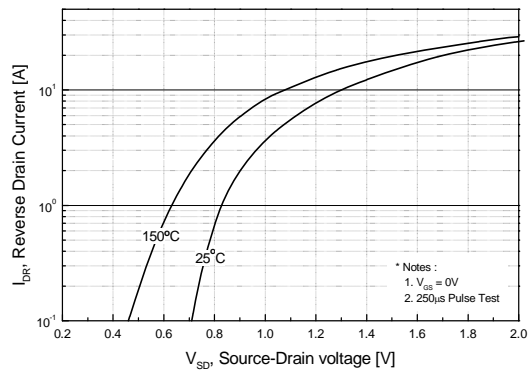
**Figure 2. Transfer Characteristics**



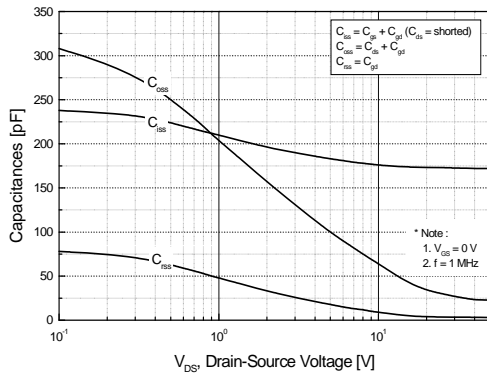
**Figure 3. On-Resistance Variation vs. Drain Current and Gate Voltage**



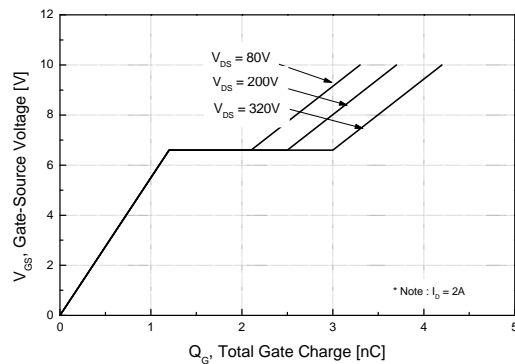
**Figure 4. Body Diode Forward Voltage Variation vs. Source Current and Temperature**



**Figure 5. Capacitance Characteristics**

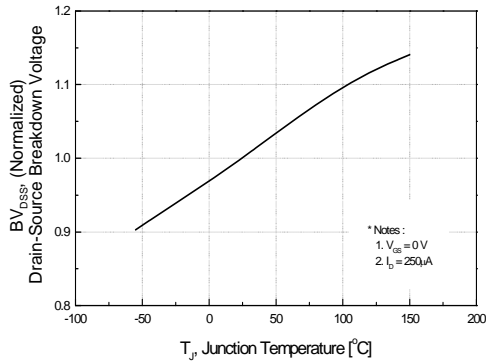


**Figure 6. Gate Charge Characteristics**

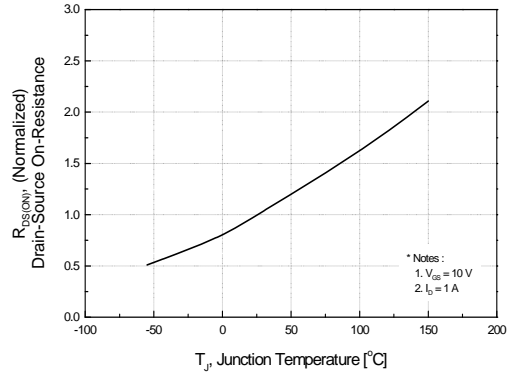


**Typical Performance Characteristics** (Continued)

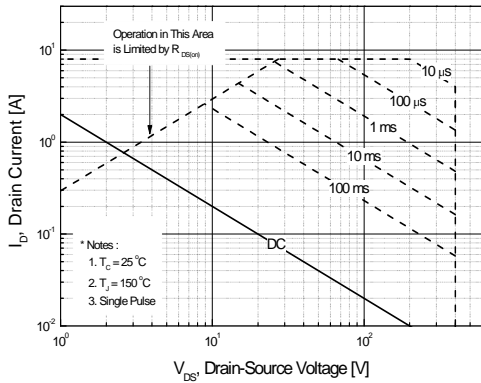
**Figure 7. Breakdown Voltage Variation vs. Temperature**



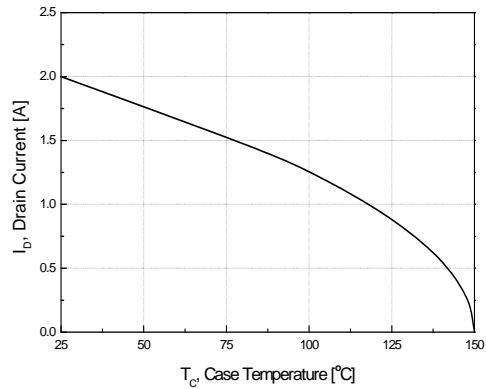
**Figure 8. On-Resistance Variation vs. Temperature**



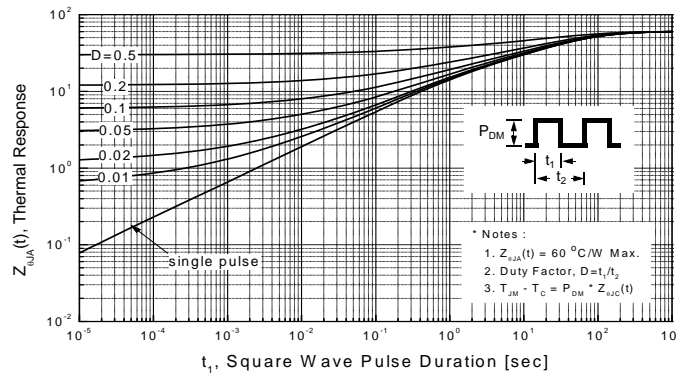
**Figure 9. Maximum Safe Operating Area**



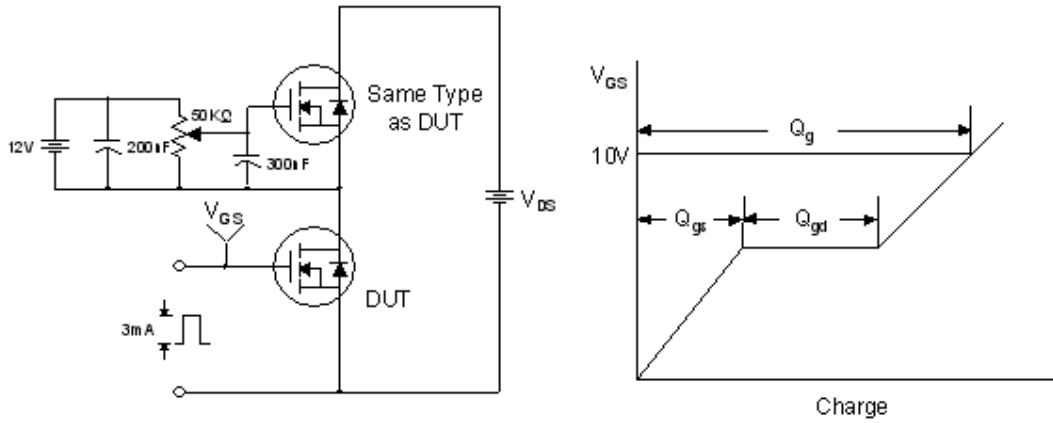
**Figure 10. Maximum Drain Current vs. Case Temperature**



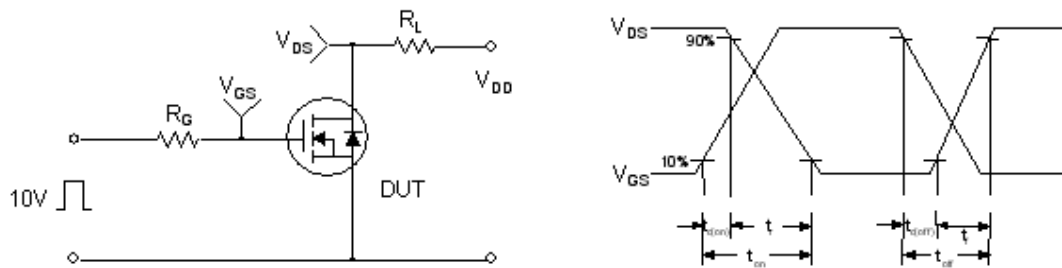
**Figure 11. Transient Thermal Response Curve**



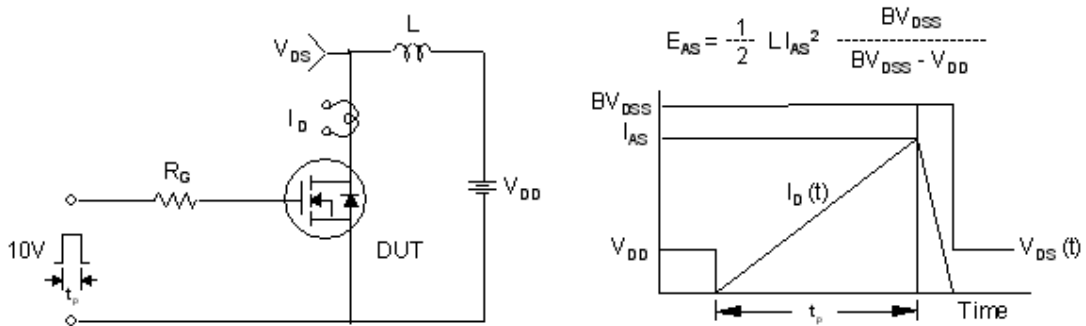
**Gate Charge Test Circuit & Waveform**



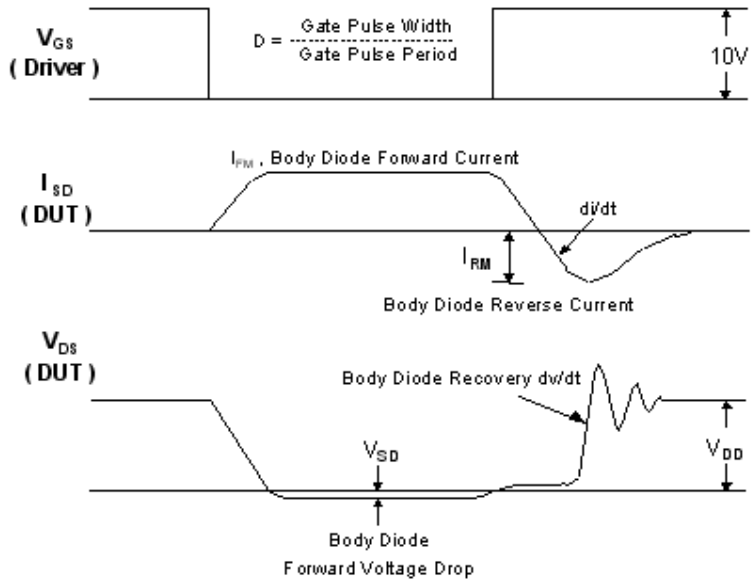
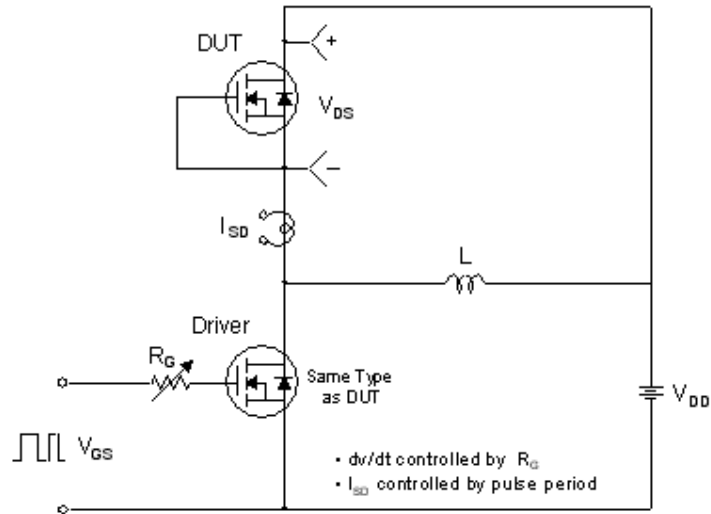
**Resistive Switching Test Circuit & Waveforms**



**Unclamped Inductive Switching Test Circuit & Waveforms**

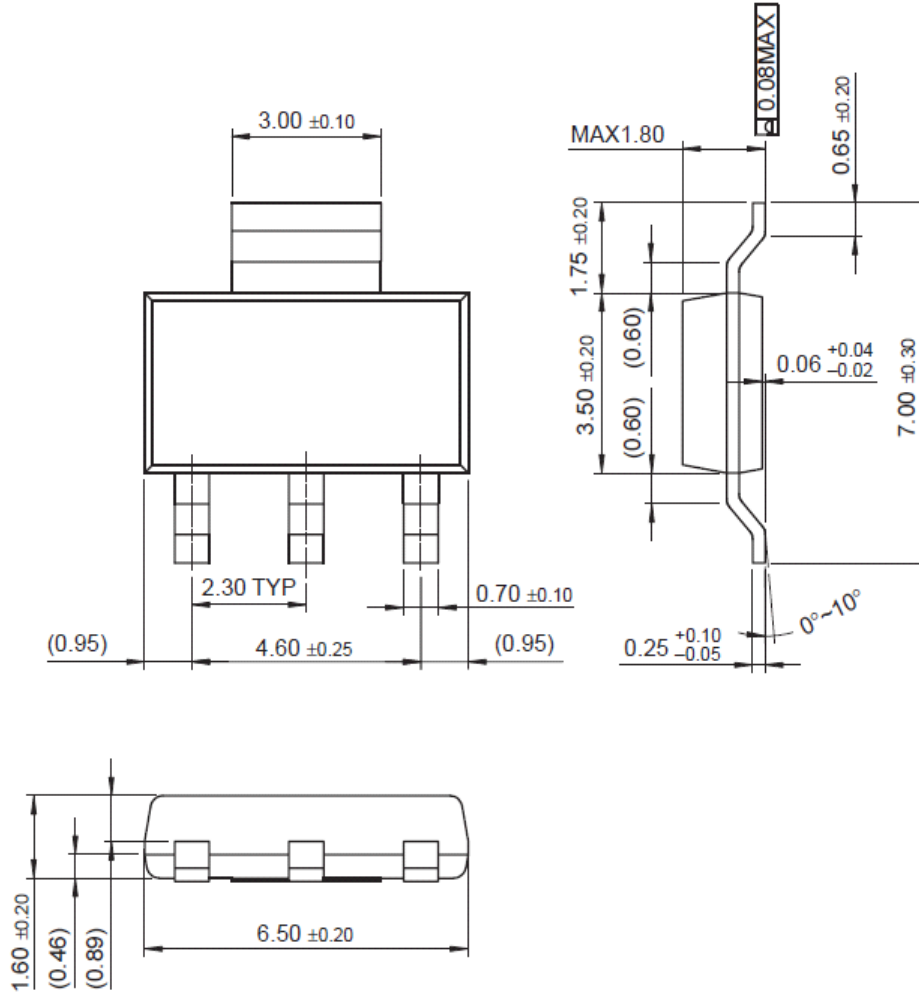


Peak Diode Recovery dv/dt Test Circuit & Waveforms



Mechanical Dimensions







SOT-223





**TRADEMARKS**

The following includes registered and unregistered trademarks and service marks, owned by Fairchild Semiconductor and/or its global subsidiaries, and is not intended to be an exhaustive list of all such trademarks.

- |  |   |   |  |
|--|---|---|--|
| AccuPower™   | FlashWriter®*   | Power-SPM™  |  <b>SYSTEM GENERAL®</b><br>The Power Franchise®<br>the <b>power</b> franchise<br>TinyBoost™<br>TinyBuck™<br>TinyCalc™<br>TinyLogic®<br>TINYOPTO™<br>TinyPower™<br>TinyPWM™<br>TinyWire™<br>TriFault Detect™<br>TRUECURRENT™*<br>μSerDes™<br> SerDes®<br>UHC®<br>Ultra FRFET™<br>UniFET™<br>VCX™<br>VisualMax™<br>XS™ |
| Auto-SPM™  | FPS™  | PowerTrench®  |  |
| Build it Now™  | F-PFS™  | PowerXS™  |  |
| CorePLUS™  | FRFET®  | Programmable Active Droop™  |  |
| CorePOWER™   | Global Power Resource <sup>SM</sup>   | QFET®   |  |
| CROSSVOLT™   | Green FPS™  | QS™   |  |
| CTL™   | Green FPS™ e-Series™  | Quiet Series™   |  |
| Current Transfer Logic™  | Gmax™   | RapidConfigure™   |  |
| DEUXPEED®  | GTO™  |  ™ |  |
| EcoSPARK®  | IntelliMAX™   | Saving our world, 1mW/W/kW at a time™   |  |
| EfficientMax™  | ISOPLANAR™  | SignalWise™   |  |
| EZSWITCH™*   | MegaBuck™   | SmartMax™   |  |
|  ™* | MICROCOUPLER™   | SMART START™  |  |
|  ™  | MicroFET™   | SPM®  |  |
| Fairchild®   | MicroPak™   | STEALTH™  |  |
| Fairchild Semiconductor®   | MillerDrive™  | SuperFET™   |  |
| FACT Quiet Series™   | MotionMax™  | SuperSOT™-3   |  |
| FACT®  | Motion-SPM™   | SuperSOT™-6   |  |
| FAST®  | OPTOLOGIC®  | SuperSOT™-8   |  |
| FAST®  | OPTOPLANAR®   | SupreMOS™   |  |
| FastvCore™   |  ™ | SyncFET™  |  |
| FETBench™  | PDP SPM™  | Sync-Lock™  |  |

\* Trademarks of System General Corporation, used under license by Fairchild Semiconductor.

**DISCLAIMER**

FAIRCHILD SEMICONDUCTOR RESERVES THE RIGHT TO MAKE CHANGES WITHOUT FURTHER NOTICE TO ANY PRODUCTS HEREIN TO IMPROVE RELIABILITY, FUNCTION, OR DESIGN. FAIRCHILD DOES NOT ASSUME ANY LIABILITY ARISING OUT OF THE APPLICATION OR USE OF ANY PRODUCT OR CIRCUIT DESCRIBED HEREIN; NEITHER DOES IT CONVEY ANY LICENSE UNDER ITS PATENT RIGHTS, NOR THE RIGHTS OF OTHERS. THESE SPECIFICATIONS DO NOT EXPAND THE TERMS OF FAIRCHILD'S WORLDWIDE TERMS AND CONDITIONS, SPECIFICALLY THE WARRANTY THEREIN, WHICH COVERS THESE PRODUCTS.

**LIFE SUPPORT POLICY**

FAIRCHILD'S PRODUCTS ARE NOT AUTHORIZED FOR USE AS CRITICAL COMPONENTS IN LIFE SUPPORT DEVICES OR SYSTEMS WITHOUT THE EXPRESS WRITTEN APPROVAL OF FAIRCHILD SEMICONDUCTOR CORPORATION.

As used herein:

- Life support devices or systems are devices or systems which, (a) are intended for surgical implant into the body or (b) support or sustain life, and (c) whose failure to perform when properly used in accordance with instructions for use provided in the labeling, can be reasonably expected to result in a significant injury of the user.
- A critical component in any component of a life support, device, or system whose failure to perform can be reasonably expected to cause the failure of the life support device or system, or to affect its safety or effectiveness.

**ANTI-COUNTERFEITING POLICY**

Fairchild Semiconductor Corporation's Anti-Counterfeiting Policy. Fairchild's Anti-Counterfeiting Policy is also stated on our external website, [www.fairchildsemi.com](http://www.fairchildsemi.com), under Sales Support.

Counterfeiting of semiconductor parts is a growing problem in the industry. All manufacturers of semiconductor products are experiencing counterfeiting of their parts. Customers who inadvertently purchase counterfeit parts experience many problems such as loss of brand reputation, substandard performance, failed applications, and increased cost of production and manufacturing delays. Fairchild is taking strong measures to protect ourselves and our customers from the proliferation of counterfeit parts. Fairchild strongly encourages customers to purchase Fairchild parts either directly from Fairchild or from Authorized Fairchild Distributors who are listed by country on our web page cited above. Products customers buy either from Fairchild directly or from Authorized Fairchild Distributors are genuine parts, have full traceability, meet Fairchild's quality standards for handling and storage and provide access to Fairchild's full range of up-to-date technical and product information. Fairchild and our Authorized Distributors will stand behind all warranties and will appropriately address any warranty issues that may arise. Fairchild will not provide any warranty coverage or other assistance for parts bought from Unauthorized Sources. Fairchild is committed to combat this global problem and encourage our customers to do their part in stopping this practice by buying direct or from authorized distributors.

**PRODUCT STATUS DEFINITIONS**

**Definition of Terms**

Datasheet Identification	Product Status	Definition
Advance Information	Formative / In Design	Datasheet contains the design specifications for product development. Specifications may change in any manner without notice.
Preliminary	First Production	Datasheet contains preliminary data; supplementary data will be published at a later date. Fairchild Semiconductor reserves the right to make changes at any time without notice to improve design.
No Identification Needed	Full Production	Datasheet contains final specifications. Fairchild Semiconductor reserves the right to make changes at any time without notice to improve the design.
Obsolete	Not In Production	Datasheet contains specifications on a product that is discontinued by Fairchild Semiconductor. The datasheet is for reference information only.