

1

2

3

4

5

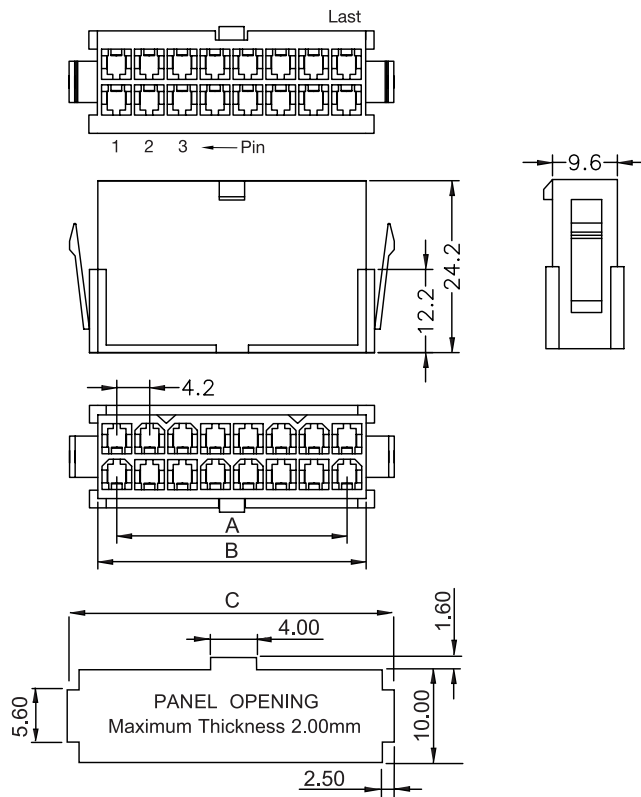

TECHNICAL CHARACTERISTICS

MATERIAL
INSULATOR: NYLON 66
FLAMABILITY RATING: UL94-V0
COLOR: WHITE
PITCH: 4.20MM

ENVIRONMENTAL
OPERATING TEMPERATURE: -40 UP TO 105°C
COMPLIANCE: LEAD FREE AND ROHS

ELECTRICAL
CURRENT RATING: 6 TO 9A

NB CIRCUITS	2-3	4-6	7-10	12-24
AMPERES	9	8	7	6

WORKING VOLTAGE: 600V AC
INSULATOR RESISTANCE: >1000 MOHM
DIELECTRIC WITHSTANDING VOLTAGE: 1500VAC/MM



STANDARD
 CERTIFIED: E323964 / MODEL NUMBER 649-218

SOLDERING
WAVE PROCESS ONLY

PACKAGING
BAG

DIMENSION
 $A = 4.20 \times (\text{NB PIN} / 2 - 1)$
 $B = 4.20 \times (\text{NB PIN} / 2) + 1.30$
 $C = 4.20 \times (\text{NB PIN} / 2) + 6.60$

RoHS Compliant

G				PROJECTION:	GENERAL TOLERANCE		DESCRIPTION: 4.20MM MALE DUAL ROW PLUG WITH PANEL MOUNT EARS WERI PART NO: 649 0xx 218 22	SIZE A4
F				.X = +/_ 0.2				
E				.XX = +/_ 0.15				
D								
C			APPROVAL: RJ	UNIT: MM	DESCRIPTION: 4.20MM MALE DUAL ROW PLUG WITH PANEL MOUNT EARS		SIZE A4	
B	18-NOV-09	STANDARD	JP	SCALE:	WERI PART NO: 649 0xx 218 22			
A	24-JUN-09	BAG PACKAGING	JP	SHEET: 1/2				
REV	DATE	FILE	BY	DRAW: DAVID				

1	2	3	4	5
---	---	---	---	---

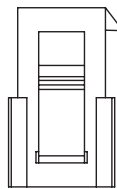
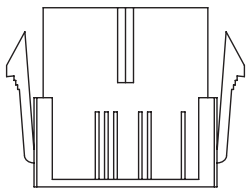
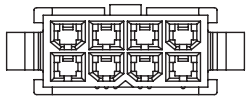

Note:
 1.Dimension:
 Carton Size:40*28*28(cm)
 2.Quantity:

Pin.	Pcs/Bag	Pcs/Carton	Pin.	Pcs/Bag	Pcs/Carton
2	1000	7000	14	300	1500
4	1000	4000	16	250	1250
6	500	3000	18	200	1000
8	500	2500	20	200	1000
10	500	2000	22	100	800
12	400	1600	24	100	700

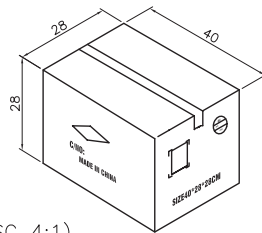
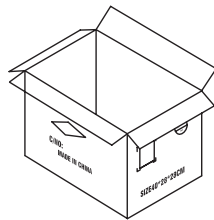
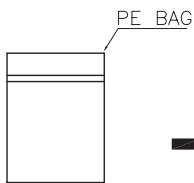

Carton (SC 4:1)

RoHS Compliant				PROJECTION: 	GENERAL TOLERANCE .X = +/- 0.2 .XX = +/- 0.15	 WÜRTH ELEKTRONIK	DESCRIPTION: 4.20MM MALE DUAL ROW PLUG WITH PANEL MOUNT EARS	SIZE
G								A4
F								
E								
D								
C								
APPROVAL: RJ				UNIT: MM	WERI PART NO: 6490 xx 21822_TPK		A4	
				SCALE:				
				SHEET: 2/2				
A				DRAW: PEARL				
REV	DATE	FILE	BY					