

May we suggest you contact the ITT Cannon technical sales office nearest you for immediate assistance with technical questions, order placement or simply to discuss your next project.

Series Prefix	Description	Page
Rack and Panel Connectors		
BKAD/E/F	ARINC 600	2-114
SGA		2-20
DPXNE/NA	MIL-C-81659	21-24
DPX Series	ARINC 404	25-40
DPXA/DPXB/DPX*MA/DPX*ME (How to Order)		41-74
DPX2/DPX2MA/DPX2ME (How to Order)		42
DPX3/DPX3MA/DPX3ME/DPX4/DPX4MA/DPX4ME (How to Order)		42
DPK Series	MIL-C-83733	43
DPA Series		75-91
DPGM/DPJM/DPJMB Series		92-95
DPD/DPDMA/DPD2/DPD2MA Series		96-102
Circular Connectors		
KJL/KJ/KJA	MIL-C-38999 Series I, II, and III	115-230
KPT/KPSE	MIL-C-26482, Series 1	115-139
PV	MIL-C-26482, Series 2	140-156
MS-E/F/R/ER	MIL-C-5015	157-166
MS/CV345*	MIL-C-5015 Rear Release	167-187
MR	Waterproof	188-195
CA-A	MIL-C-5015 Type	196-198
MS-K, CA-KE, FRF/FVR/FRA/FVA	Firewall Connectors	199-201
KFS	MIL-C-28840	202-217
CA-B, CA-COM, CGE	Bayonet Coupling	218-223
Microminiature Connectors		
• MICRO .050" Contact Spacing		224-230
MDM	Micro-D ® Metal Shell	231-295
	Connector Saver	231-276
	Printed Circuit Board	232-239
MDM-PCB	Coaxial/Power	239
MDM-C/P	Micro-D Plastic Shell	242-245
MD	Printed Circuit Board	242-245
MDB-PCB	Coaxial	246
MDB/Coaxial	Microminiature Center Jackscrew	247-250, 255-257
MJS	Microminiature Circular	251-252
MICRO-K	Plastic Shell - Screw Coupling	253-254
MIK	Metal Shell - Screw Coupling	258-262
MIKM	Metal Shell - Quick Disconnect	263
MIKQ	Plastic Shell - Quick Disconnect	264
MIKQP	Microminiature Strip .100"/.075"	265
MT	Microminiature Edgeboard	265-266
MEB/MEBL		267
• CENTI .075" Contact Spacing		268-271
2D	Double Density D	272-276
2DD	Environmental Double Density D	277-290
CDL	Centi-D Loc	278-282
CTA	Strip Connectors .100"/.075'	283-285
• NANO .025" Contact Spacing		286
NT	Strip Connectors	287-290
NDM	NANO-D Metal Shell	291-295
NJS	Center Jackscrew	292
Fiber Optic Connectors		
Filter Connectors		
Special Application Connectors		
	Hermetic Connectors	296-303
	Battery Connectors	304-326
D Subminiature Connectors		
	Standard MIL-Spec D	327-331
	Combo D ®	327-328
	Environmental Products	329-331
	Accessories	332-385
Reference		
	Contacts, Crimp-MIL-C-39029	331-343
	Index	344-357
		358-366
		367-385
		386-392
		386
		387-392

- Low insertion force contacts.
- Both environmental and non- environmental versions.
- Polarizing posts that are removable from the mating face.
- Field replaceable inserts for size 22 and power contacts.
- Up to 800 size 22 contacts in one connector.
- Crimp, coax, power, printed circuit and wire wrappable post style contacts.
- Uses standard DPX crimp, insertion/extraction tooling.
- Waveguide connections available.



BKAD/E

Rear Release/Rear Removable
Size 12, 16, 20, 22 Crimp Contacts

BKAD/E connectors represent a major milestones in presenting a new rack and panel connector for support of the air transportation market. Several important design concerns have been addressed and solved in this new series. High mating forces of pluggable modules in a rack have been reduced by approximately two-thirds.

The low insertion force contacts are also interchangeable with the contacts used in the DPX series and permit retrofit of existing equipment.

BKAF

Front Release/Front Removable
Size 22 Solder Tail and Wrap Post Contacts

This new connector is totally intermateable and intermountable with ARINC 600 connectors now in the field.

The BKAF permits the user to easily replace a contact in case of problems, rather than disassemble the entire connector--it is available with size 22 contacts in wrap post or solder-tail versions. The system maintains the advantages of low insertion force technology incorporated in all ARINC 600 connectors.

Pos-Aline Connector Construction Feature

In the ARINC 600 connector series, Size 22 contacts are the only size that utilize this design feature. The hooded socket extends from its insulator while the pin contacts are shrouded by its front insulator. All other contacts used in this series employ standard contact design.

The result is that the complement of contacts for the plug connectors will consist of pin contacts for size 22 and socket contacts for all others. The receptacle contacts will be just the reverse, socket contact for size 22 and pin contacts for the balance.

Material Specifications

		BKAD	BKAE	BKAF	Specifications
Shell & Waveguide	Material	Aluminum alloy	Aluminum alloy	Aluminum alloy	QQ A-591/A380
	Finish	Alodine 1200	Alodine 1200	Alodine 1200	MIL-C-5541
Insulator	Material	Thermoset	Thermoset	Thermoset	N/A
	Material	Copper alloy	Copper alloy	Copper alloy	QQ-C-533
Contacts	Finish	Gold over Nickel	Gold over Nickel	Gold over Nickel	MIL-G-45204
	Termination	Crimp	Crimp	P.C./Wrap Post	N/A
Grommets/Seals	Material	N/A	Silicone-based Elastomer	N/A	N/A
O-Ring	Material	N/A	Silicone-based Elastomer	N/A	N/A

How to Order

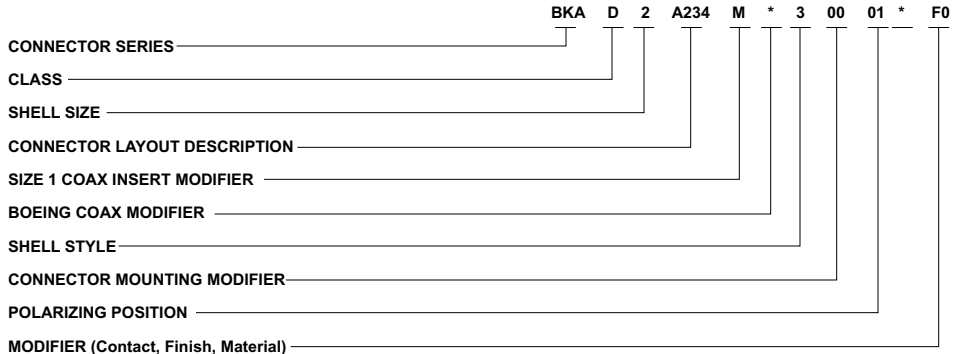

* = For Polarizing Position greater than 99, add third digit.

CONNECTOR SERIES

BKA (Per ARINC 600)

CLASS

- D - Non-environmental (rear release, crimp contacts)
- E - Environmental (rear release, crimp contacts)
- F - Non-environmental (front release, solder and wrap post #22 contact, rear release all others)
- C - Same as E, except uses BKAD shells, and Less 0 rings on plug side.
- S - Environmental (0-ring is used to seal between connector shell and insulators) with rear release, crimp contacts.
- T - Non-environmental connector using filtered contacts (reference Cannon Phoenix)

SHELL SIZE

- 1 - Max. contact capacity - 125
- 2 - Max. contact capacity - 400
- 3 - Max. contact capacity - 800

CONNECTOR LAYOUT DESCRIPTION

(See page 4)

SIZE 1 COAX INSERT MODIFIER

- M - Connector contains modified 71W1 or 2W2 insert (four MTG screw hole locations and coaxial contact used in this insert are interchangeable between different manufacturers)

NOTE: A dash must be inserted whenever code does not apply.

BOEING COAX MODIFIER

Boeing Coax Code	ITTC Code	ITTC Coax Contacts Supplied	
		Plug Connector	Receptacle Connector
AA	Blank	No Coax Supplied	No Coax Supplied
AB	B	349-0013-000	349-0014-000
AC	C	349-0015-000	349-0016-000
AD	D	349-0013-000 349-0017-000	349-0014-000 349-0002-000
AE	E	349-0015-000 349-0018-000	349-0016-000 349-0004-000
AF	F	349-0015-000 349-0017-000	349-0016-000 349-0002-000

SHELL STYLE

- 3 - Plug (rack side)
- 4 - Receptacle (box side)

CONNECTOR MOUNTING MODIFIER

- 00 - Standard design, .148 dia. holes
- 01 - With #6-32 ESNA (#12 NCFMA2-62) clinch nuts (see chart)

Connector Size	Number of Clinch Nuts	
	Plug	Receptacle
1	4	4
2	4	6
3	8	10

- 02 - Size 1 receptacle only - less 3 printed circuit board mounting lugs
- 03 - With #4-40 ESNA (#22 NCFMA2-40) clinch nuts (see chart)
- 08 - Size 2 and 3 plug and receptacle only - with #4-40 ESNA (#22 NCFMA2-40) clinch nuts (all mounting holes)
- 09 - Size 2 and 3 plug and receptacle only - with #6-32 ESNA (#12 NCFMA2-62) clinch nuts (all mounting holes)
- 16 - Same as - 00 mounting modification except with nickel finished shells .0008 - .0012 thick with EMI grounding spring for plug shells and supplied with non-environmental inserts.
- 17 - Same as - 00 mounting modification except with nickel finished shells .0008 - .0012 thick with EMI grounding spring for plug shells and supplied with environmental inserts not potted into shell.
- 23 - With floating eyelets (.048 min. radial float) 4 corner holes per connector.
Consult factory if other modifications are required

How to Order (Continued)

CONNECTOR LAYOUT DESCRIPTION Note: All layouts with "OPEN" insert cavity are not supplied with an insulator. If a Blank insert is required please consult factory. Three Digit Number Contained within the Shell Layout Indicates Total Number of Contacts Available (including Waveguide)

Connector Layout	Shell Size	Shell Cavity Identification						Ref. ARINC Characteristic	Connector Layout	Shell Size	Shell Cavity Identification						Ref. ARINC Characteristic
		A	B	C	D	E	F				A	B	C	D	E	F	
-005	1	OPEN	OPEN	5W2				-T173	2	150	10T10	13W2					
-060	1	OPEN	60	OPEN				234	2	150	71W1	13W2				709	
A060	1	60	OPEN	OPEN				A234	2	71W1	150	13W2				727	
-065	1	OPEN	60	5W2				-246	2	120T2	120T2	6T6					
A065	1	60	Open	5W2				-248	2	121	121	6T6					
-120	1	60	60	OPEN				250	2	OPEN	150	100					
-125	1	60	60	5W2			●	250A	2	150	BLANK	100					
-013	2	OPEN	OPEN	13W2				-251	2	Waveguide	150	100					
-017	2	2W2	2W2	13W2				-300	2	150	150	OPEN					
-071	2	OPEN	71W1	OPEN				-306	2	150	150	6T6					
A071	2	71W1	OPEN	OPEN				-313	2	150	150	13W2			● ● ●		
-085	2	Waveguide	71W1	13W2				-370	2	150	120T2	100					
A085	2	71W1	Waveguide	13W2				-400	2	150	150	100					
86M	2	2W2	71W1A	13W2				-021	3	4W4	4W4	13W2	BLANK	OPEN	OPEN		
-093	2	4W4	4W4	85				-026	3	OPEN	OPEN	13W2	OPEN	OPEN	13W2		
-100	2	OPEN	OPEN	100				-113	3	OPEN	OPEN	100	OPEN	OPEN	13W2		
-137	2	121	10T10	6T6				-A113	3	OPEN	OPEN	13W2	OPEN	OPEN	100		
-T141	2	120T2	10T10	13W2				-114	3	4W4	4W4	4W4	4W4	13W2	85		
-142	2	71W1	71W1	OPEN				-284	3	71W1	71W1	OPEN	71W1	71W1	OPEN		
-155	2	71W1	71W1	13W2			● ●	-310	3	71W1	71W1	13W2	71W1	71W1	13W2		
155M	2	71W1A	71W1A	13W2				-330M	3	2W1	2W2	13W2	150	150	13W2		
V155M	2	71W1B	71W1A	13W2				-A330M	3	150	150	13W2	2W2	2W2	13W2		
158M	2	2W2	71W1A	85				-496	3	121	121	121	121	6T6	6T6		
-A158M	2	2W2	71W1B	85				-600	3	150	150	OPEN	150	150	OPEN		
-163	2	OPEN	150	13W2				-626	3	150	150	13W2	150	150	13W2	● ● ● ●	
A163	2	150	OPEN	13W2				-713	3	150	150	100	150	150	13W2		
-164	2	150	Waveguide	13W2				A713	3	150	150	13W2	150	150	100		
A164	2	Waveguide	150	13W2			708	-734	3	150	150	100	150	150	3W		
165M	2	150	2W2	13W2				-764	3	150	150	64	150	150	100		
-A165M	2	2W2	150	13W2				-800	3	150	150	100	150	150	100		
-167	2	4W4	150	13W2				-269M	3	2W2	2W2	13W2	2W2	150	100	732	
173M	2	2W2	71W1B	100				271C	3	4W4	4W4	13W2	BLANK	150	100		
								271M	3	2W2	2W2	13W2	4W4	150	100		
								-326	3	OPEN	150	13W2	OPEN	150	13W2		

NOTE. ANY OTHER COMBINATION OF INSERTS WITHIN A SPECIFIC SHELL IS AVAILABLE UPON REQUEST

- Layout included in the following ARINC configurations 702, 710, 711, 712, 714, 715, 716, 723.
- ● Layout included in the following ARINC configurations 707, 718 & 730.
- ● ● Layout included in the following ARINC configurations 701, 702, 703, 704, 705, 706, 724, 725.
- ● ● ● Layout included in the following ARINC configurations 701, 717, 726, 729.

POLARIZING POSITION

01 thru 99 (per ARINC 600)

Blank-Polarizing posts or keys not installed but supplied with connector

MODIFIER (Contact, Finish, Material)

- Blank - Rear release, crimp, signal and power contacts supplied with connector (when applicable)
- FO - Contacts not supplied with connector (FO not stamped on connector)
- FOO - Less contacts and waveguide (FOO not stamped on connector)
- SA - Front release .025(0.63) D. x .150 (3.81) solder post and crimp, rear release power contacts (when applicable) supplied with connector
- SB - Front release .025(0.63) D. x .250 (6.35) solder post and crimp, rear release power contacts (when applicable) supplied with connector

- SC - Front release .025(0.63) D. x .375 (9.53) solder post and crimp, rear release power contacts (when applicable) supplied with connector
- SD - Front release .025(0.63) D. x .500 (12.7) solder post and crimp, rear release power contacts (when applicable) supplied with connector
- WA - Front release .025(0.63) Sq. x .250 (6.35) (1 wrap) wrap post and crimp, rear release power contacts (when applicable) supplied with connector
- WB - Front release .025(0.63) Sq. x .375 (9.53) (2 wraps) wrap post and crimp, rear release power contacts (when applicable) supplied with connector

- WC - Front release .025(0.63) Sq. x 500 (12.7) (3 wraps) wrap post and crimp, rear release power contacts (when applicable) supplied with connector
- WD - Front release .025 (0.64) Sq. x 641 (16.28) (3 wraps) wrap post and crimp, rear release power contacts (when applicable) supplied with connector

NOTE: COAXIAL CONTACTS TO BE ORDERED SEPARATELY

Shell Dimensions - Size 1

Plug

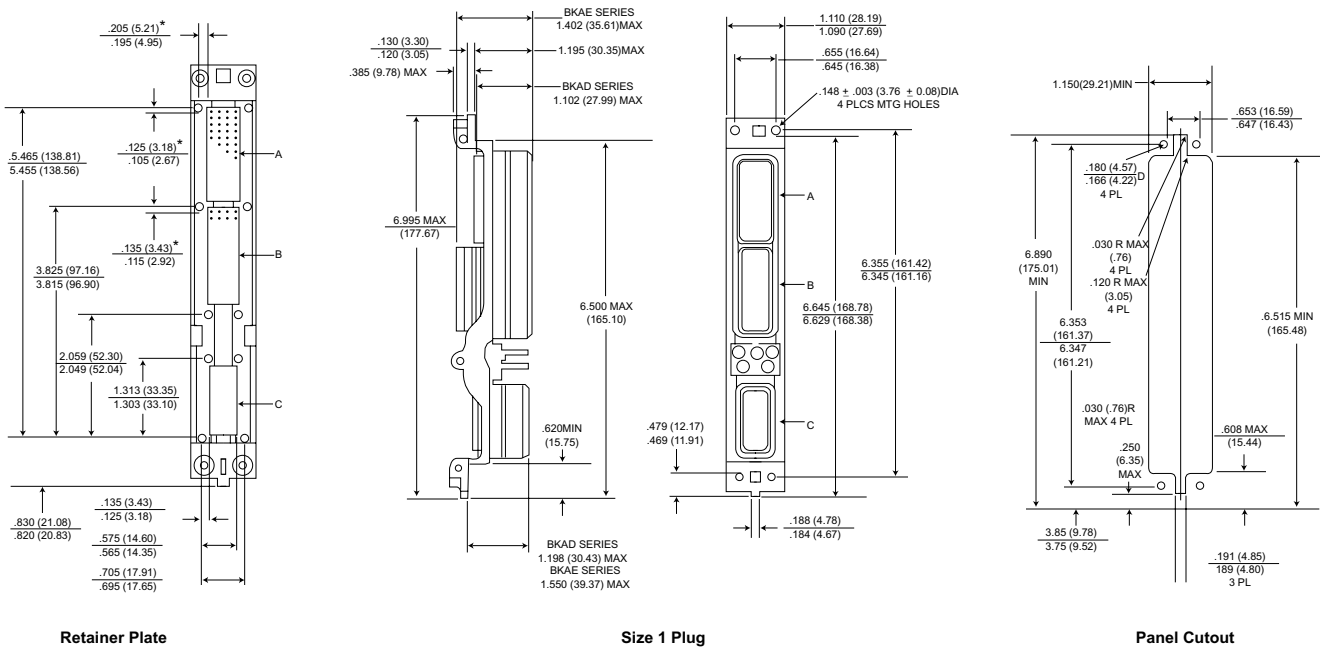

* This dimension indicates distance from centerline of retaining screw to the centerline of first contact cavity.

For further information, refer to ARINC 600 specification or consult factory.

Receptacle

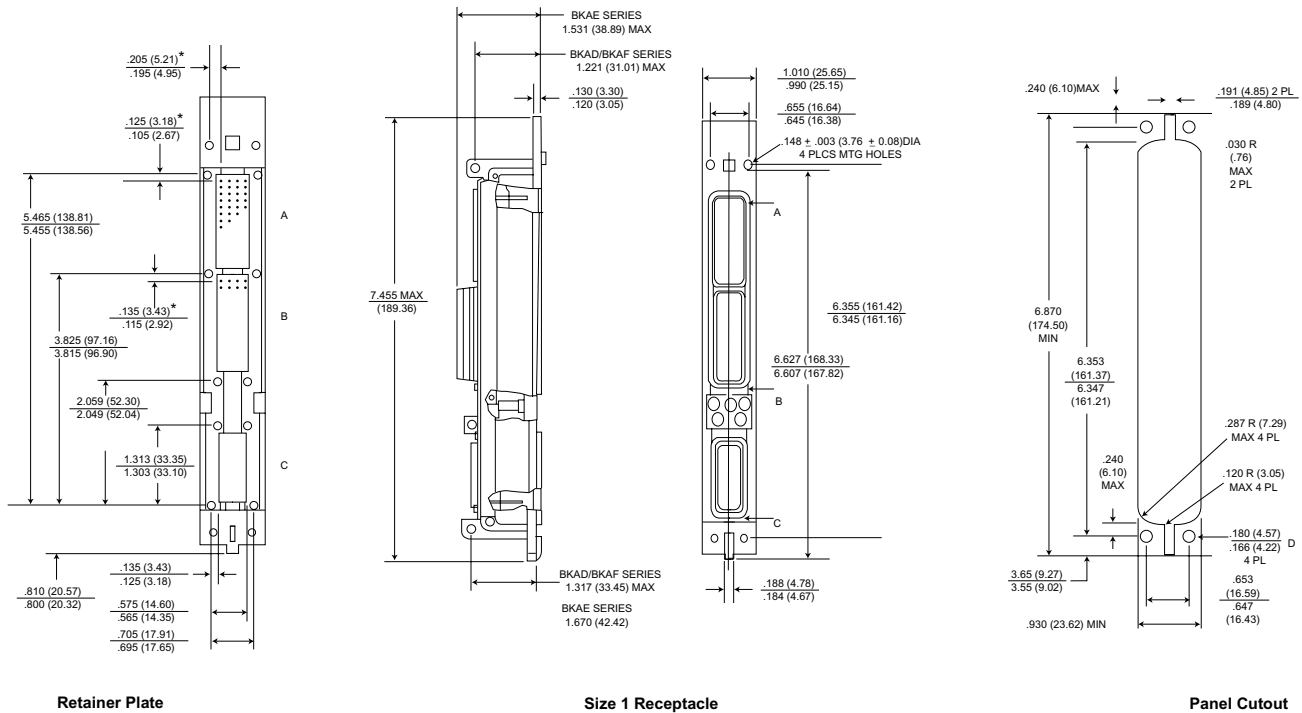

*This dimension indicates distance from centerline of retaining screw to the centerline of first contact cavity.

For further information, refer to ARINC 600 specification or consult factory.

Shell Dimensions - Size 3

Plug

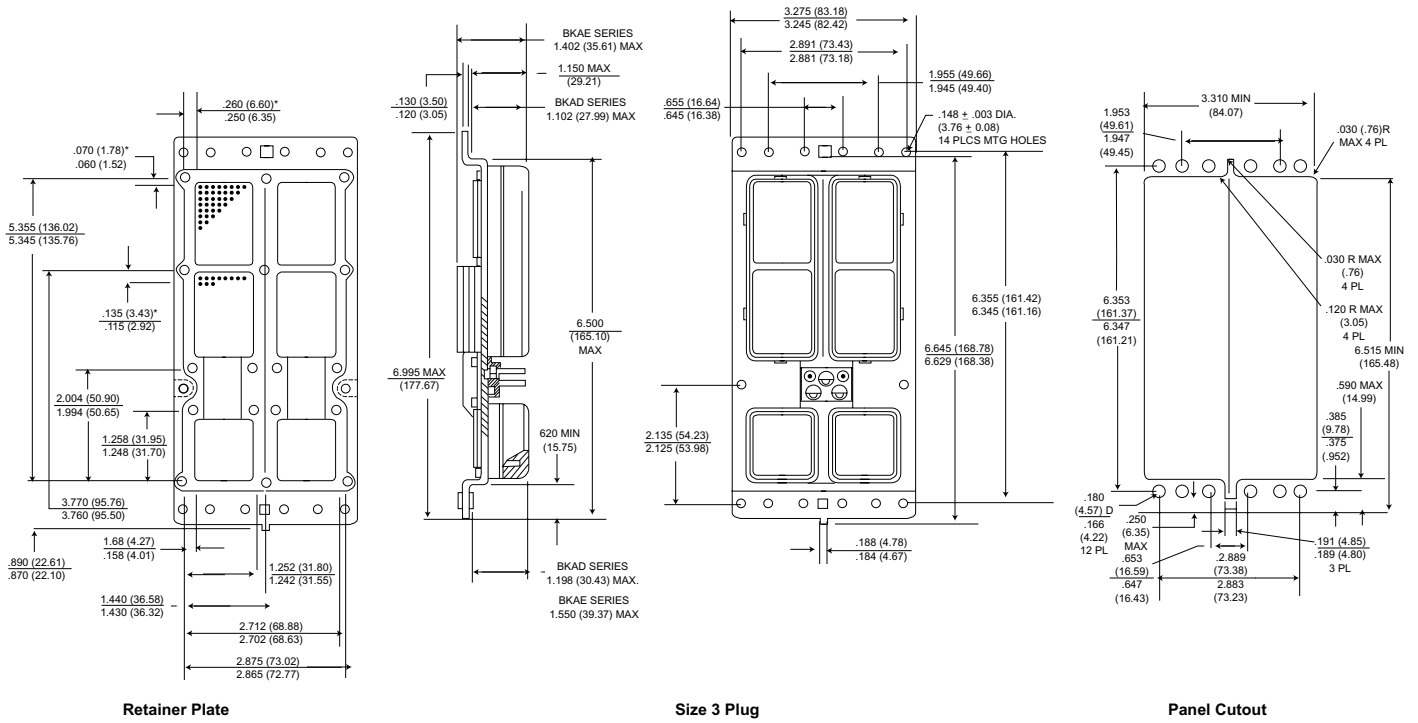

* This dimension indicates distance form centerline of retaining screw to the centerline of first contact cavity.

For further information, refer to ARINC 600 specification or consult factory.

Receptacle

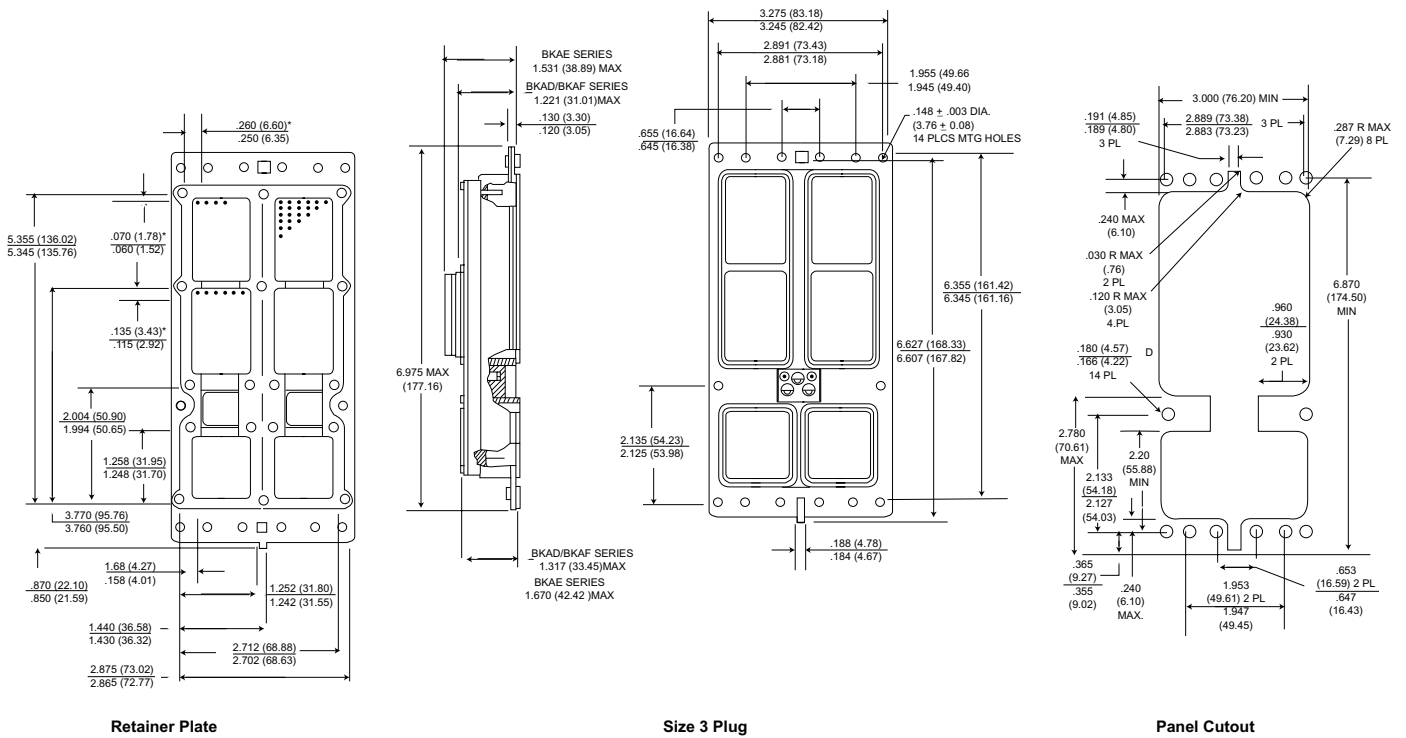

* This dimension indicates distance form centerline of retaining screw to the centerline of first contact cavity.

For further information, refer to ARINC 600 specification or consult factory.

Contact Arrangements - Shell Size 1

BKAD/BKAE (Plug Rear face shown)

Shell Cavity
A or B

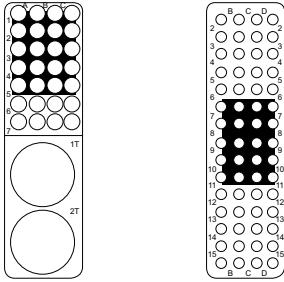

30T2
28 #22
2 #8 TWINAX/COAX
(#8 Grounded to Shell)

60
60 #22

Shell Cavity
C

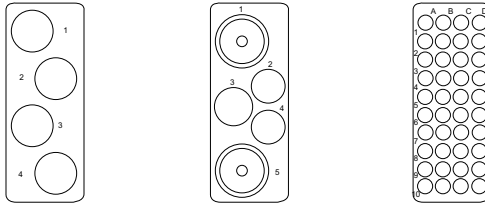

4
4 #12

5W2
1 #12
2 #16
2 #5 COAX

40
40 #22

BKAF - Available Receptacle Shell Only
(Front Release)

Shell Cavity
A or B

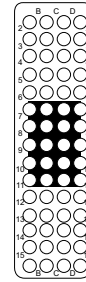

60
60 #22

Shell Cavity
C

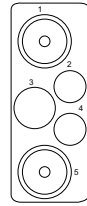

5W2
1 #12
2 #16
2 #5 COAX

REAR SURFACE WHITE ON BLUE TO INDICATE REAR RELEASE REAR REMOVAL CONTACTS

ENGAGING END SURFACE WHITE ON RED TO INDICATE FRONT RELEASE FRONT REMOVAL CONTACTS

(For Contact Cavity Location and Contact Cavity Identification refer to ARINC 600 or consult factory)

Contact Arrangements - Shell Sizes 2 and 3

BKAD/BKAE (Plug Rear face shown)

Shell Cavity
C or F

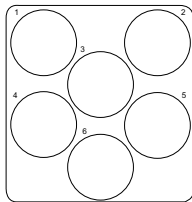

6**
6 #8

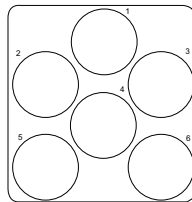

6T6**
6 #8
(Metallic Insert)

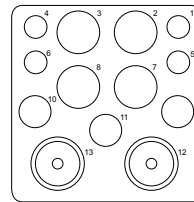

13W2
4 #20, 4 #12, 3 #16
2 #5 COAX

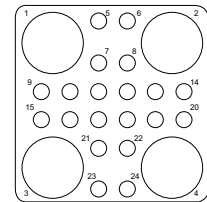

24T4**
20 #20, 4 #8

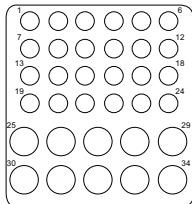

34**
24 #20, 10 #18

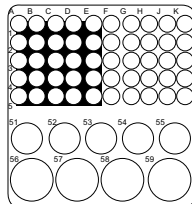

59**
50 #22, 5 #16, 4 #12

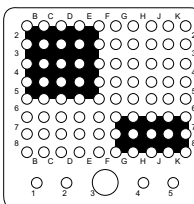

85
80 #22, 4 #20, 1 #16

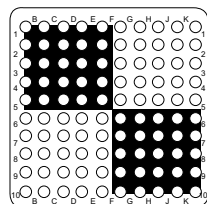

100
100 #22

**Pending ARINC release.

NOTE: In layouts using #22 contacts mixed with any other contact size (20HD, 16, 12), the size #22 contact type (pin or socket) determines the insulator as a pin insert or a socket insert.

REAR SURFACE WHITE ON BLUE TO INDICATE REAR RELEASE, REAR REMOVAL CONTACTS FOR INSERTS CONTAINING STANDARD SIGNAL & POWER CONTACTS

(For Contact Cavity Location and Contact Cavity Identification refer to ARINC 600 or consult factory)

Contact Arrangements - Shell Sizes 2 and 3

BKAD/BKAE (Plug Rear face shown)

Shell Cavity
A,B,D,E

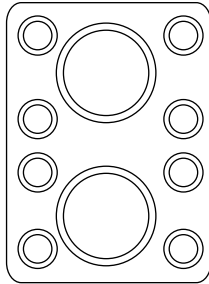

2W2
2 #1 COAX

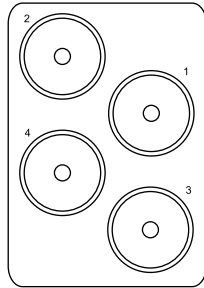

4W4
4 Modified
#1 COAX
(Metallic Insert)

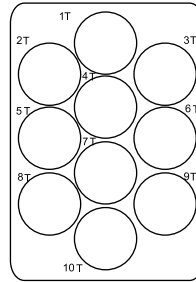

10T10**
10 #8 TRIAX/COAX
(#8 Grounded to Shell)
(Metallic Insert)

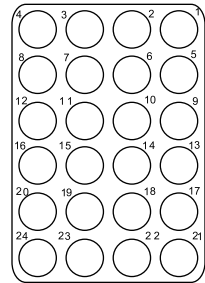

24**
24 #12

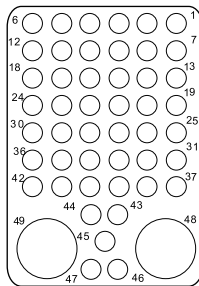

49T2**
47 #20
2 #8

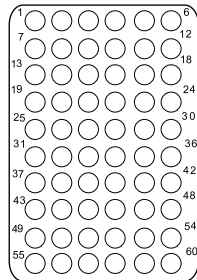

60**
60 #20

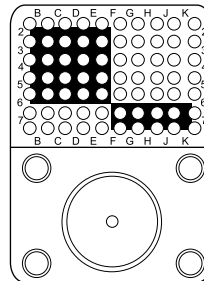

71W1
70 #22
1 #1 COAX

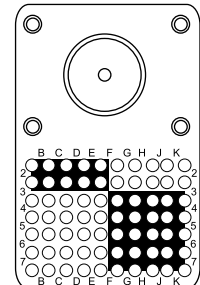

71W1B
70 #22
1 #1 COAX

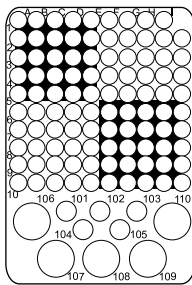

110**
100 #22
5 #12 & 5 #20

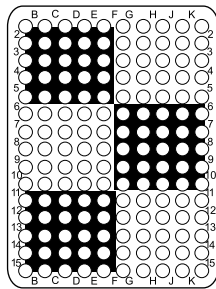

150
150 #22

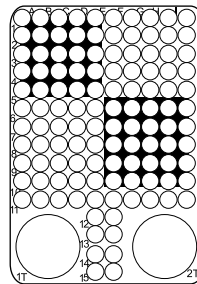

120T2**
118 #22
2 #8 TWINAX/COAX
(#8 Grounded to Shell)

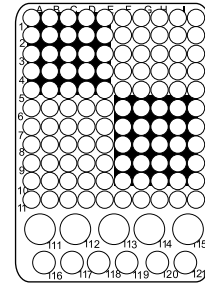

121**
110 #22
5 #16
6 #20

** Pending ARINC release.

REAR SURFACE WHITE ON BLUE TO INDICATE REAR RELEASE. REAR REMOVAL CONTACTS FOR INSERTS CONTAINING STANDARD SIGNAL & POWER CONTACTS

(For Contact Cavity Location and Contact Cavity Identification refer to ARINC 600 or consult factory)

Contact Arrangements - Shell Sizes 2 and 3

BKAF - Available Receptacle Shell ONLY

(Front Release)

SHELL CAVITY

A, B, D, E,

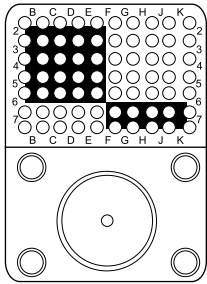

71W1
70 #22

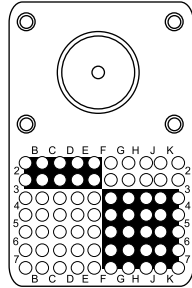

71W1B
70 #22

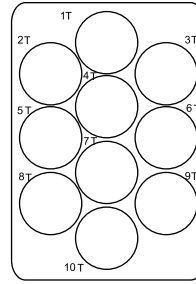

10T10**
10 #8

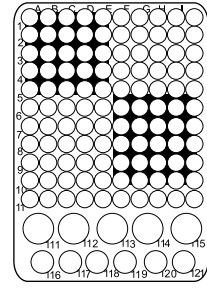

121F**
110 #22
6 #20
5 #16

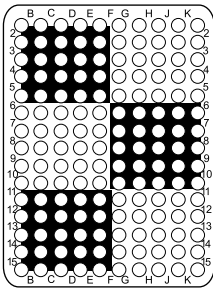

150
150 #22

ENGAGING END SURFACE WHITE ON RED TO INDICATE FRONT RELEASE FRONT REMOVAL CONTACTS FOR INSERTS CONTAINING STANDARD SIGNAL & POWER CONTACTS

BKAF - Available Receptacle Shell ONLY

(Front Release)

SHELL CAVITY C, F

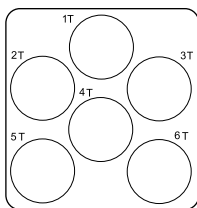

6T6**
6 #8

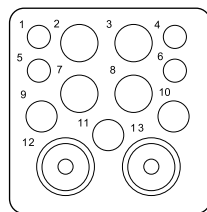

13W2
4 #20
3 #16
4 #12
2 #5 COAX

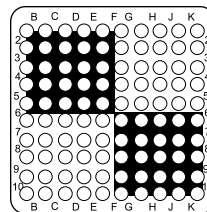

100
100 #22

** Pending ARINC release.

NOTE #22 CONTACTS ARE SOCKETS, 20HD,16, 12 ARE PIN CONTACTS.

ENGAGING END SURFACE WHITE ON RED TO INDICATE FRONT RELEASE, FRONT REMOVAL CONTACTS FOR INSERTS CONTAINING STANDARD SIGNAL & POWER CONTACTS

(For Contacts Cavity Location and Contact Cavity Identification refer to ARINC 600 or Consult Factory)

Waveguide Connections

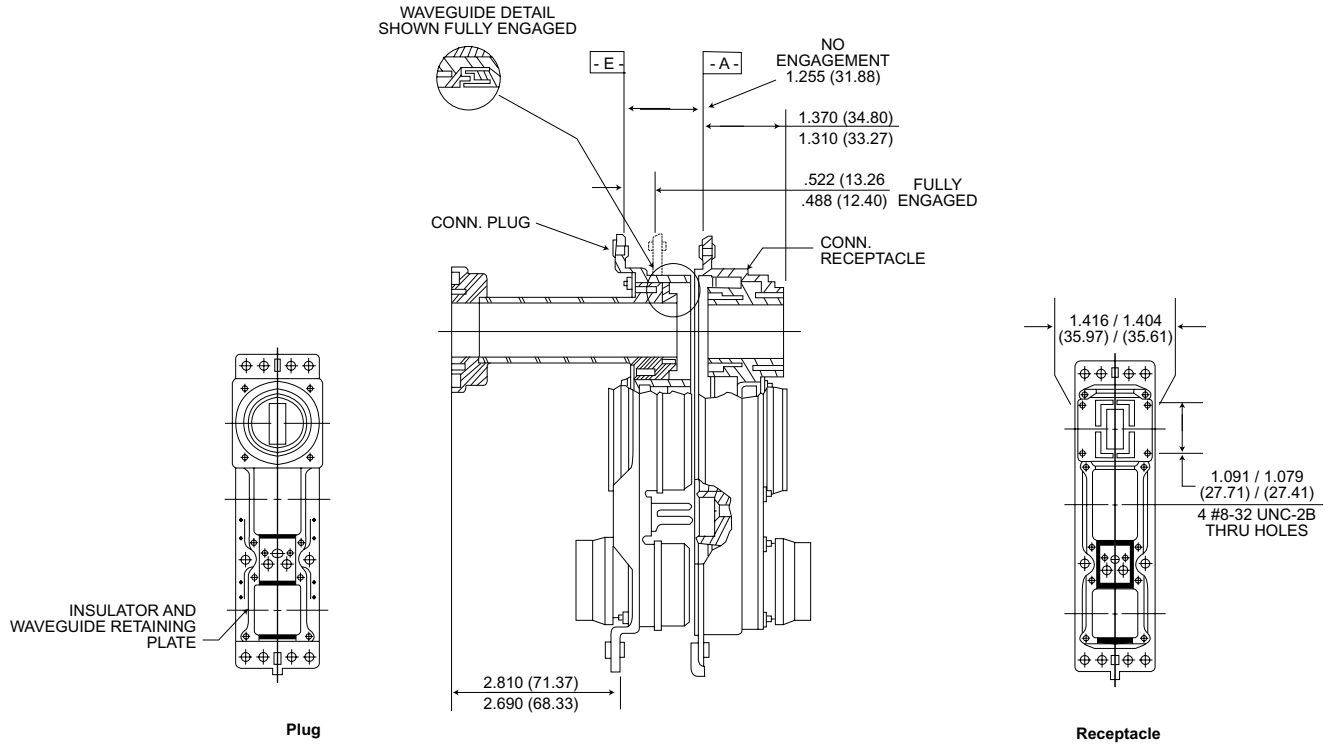

Polarization (Engaging End)

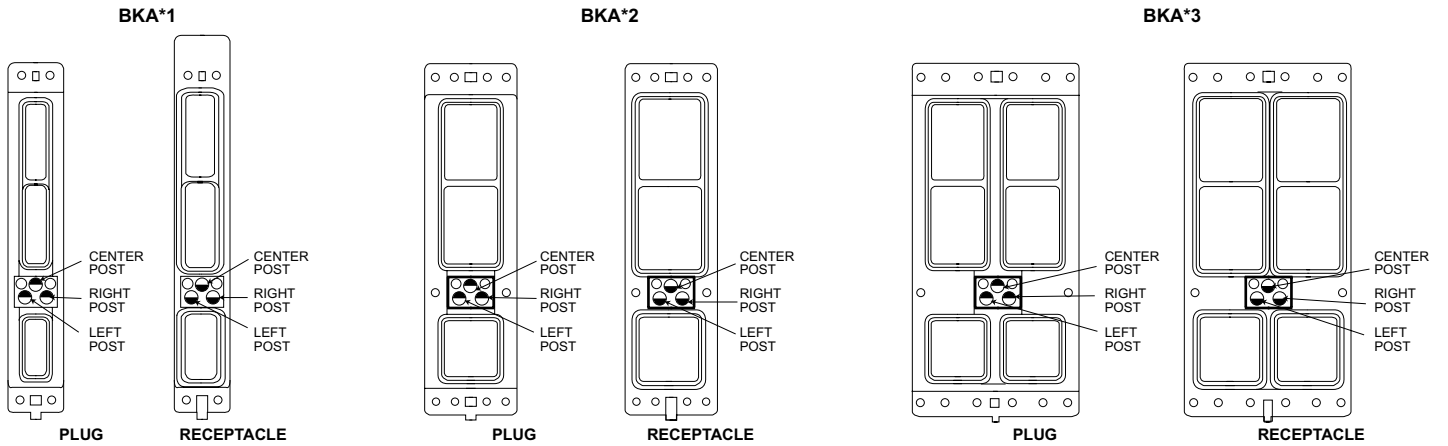

Polarizing Positions

POST



Kit P/N 320-1067-003

KEY



Kit P/N 320-1067-000

Plug Shell

Receptacle Shell

Position	Left Post	Center Post	Right Post	Position	Left Post	Center Post	Right Post	Position	Left Post	Center Post	Right Post	Position	Left Post	Center Post	Right Post	Position	Left Post	Center Post	Right Post	Position	Left Post	Center Post	Right Post
01	1	1	1	76	4	3	1	151	1	5	6	01	4	4	4	76	4	2	1	151	5	6	4
02	2	1	1	77	5	3	1	152	2	5	6	02	4	4	3	77	4	2	6	152	5	6	3
03	3	1	1	78	6	3	1	153	3	5	6	03	4	4	2	78	4	2	5	153	5	6	2
04	4	1	1	79	1	3	6	154	4	5	6	04	4	4	1	79	5	2	4	154	5	6	1
05	5	1	1	80	2	3	6	155	5	5	6	05	4	4	6	80	5	2	3	155	5	6	6
06	6	1	1	81	3	3	6	156	6	5	6	06	4	4	5	81	5	2	2	156	5	6	5
07	1	1	6	82	4	3	6	157	1	5	5	07	5	4	4	82	5	2	1	157	6	6	4
08	2	1	6	83	5	3	6	158	2	5	5	08	5	4	3	83	5	2	6	158	6	6	3
09	3	1	6	84	6	3	6	159	3	5	5	09	5	4	2	84	5	2	5	159	6	6	2
10	4	1	6	85	1	3	5	160	4	5	5	10	5	4	1	85	6	2	4	160	6	6	1
11	5	1	6	86	2	3	5	161	5	5	5	11	5	4	6	86	6	2	3	161	6	6	6
12	6	1	6	87	3	3	5	162	6	5	5	12	5	4	5	87	6	2	2	162	6	6	5
13	1	1	5	88	4	3	5	163	1	5	4	13	6	4	4	88	6	2	1	163	1	6	4
14	2	1	5	89	5	3	5	164	2	5	4	14	6	4	3	89	6	2	6	164	1	6	3
15	3	1	5	90	6	3	5	165	3	5	4	15	6	4	2	90	6	2	5	165	1	6	2
16	4	1	5	91	1	3	4	166	4	5	4	16	6	4	1	91	1	2	4	166	1	6	1
17	5	1	5	92	2	3	4	167	5	5	4	17	6	4	6	92	1	2	3	167	1	6	6
18	6	1	5	93	3	3	4	168	6	5	4	18	6	4	5	93	1	2	2	168	1	6	5
19	1	1	4	94	4	3	4	169	1	5	3	19	1	4	4	94	1	2	1	169	2	6	4
20	2	1	4	95	5	3	4	170	2	5	3	20	1	4	3	95	1	2	6	170	2	6	3
21	3	1	4	96	6	3	4	171	3	5	3	21	1	4	2	96	1	2	5	171	2	6	2
22	4	1	4	97	1	3	3	172	4	5	3	22	1	4	1	97	2	2	4	172	2	6	1
23	5	1	4	98	2	3	3	173	5	5	3	23	1	4	6	98	2	2	3	173	2	6	6
24	6	1	4	99	3	3	3	174	6	5	3	24	1	4	5	99	2	2	2	174	2	6	5
25	1	1	3	100	4	3	3	175	1	5	2	25	2	4	4	100	2	2	1	175	3	6	4
26	2	1	3	101	5	3	3	176	2	5	2	26	2	4	3	101	2	2	6	176	3	6	3
27	3	1	3	102	6	3	3	177	3	5	2	27	2	4	2	102	2	2	5	177	3	6	2
28	4	1	3	103	1	3	2	178	4	5	2	28	2	4	1	103	3	2	4	178	3	6	1
29	5	1	3	104	2	3	2	179	5	5	2	29	2	4	6	104	3	2	3	179	3	6	6
30	6	1	3	105	3	3	2	180	6	5	2	30	2	4	5	105	3	2	2	180	3	6	5
31	1	1	2	106	4	3	2	181	1	6	1	31	3	4	4	106	3	2	1	181	4	5	4
32	2	1	2	107	5	3	2	182	2	6	1	32	3	4	3	107	3	2	6	182	4	5	3
33	3	1	2	108	6	3	2	183	3	6	1	33	3	4	2	108	3	2	5	183	4	5	2
34	4	1	2	109	1	4	1	184	4	6	1	34	3	4	1	109	4	1	4	184	4	5	1
35	5	1	2	110	2	4	1	185	5	6	1	35	3	4	6	110	4	1	3	185	4	5	6
36	6	1	2	111	3	4	1	186	6	6	1	36	3	4	5	111	4	1	2	186	4	5	5
37	1	2	1	112	4	4	1	187	1	6	6	37	4	3	4	112	4	1	1	187	5	5	4
38	2	2	1	113	5	4	1	188	2	6	6	38	4	3	3	113	4	1	6	188	5	5	3
39	3	2	1	114	6	4	1	189	3	6	6	39	4	3	2	114	4	1	5	189	5	5	2
40	4	2	1	115	1	4	6	190	4	6	6	40	4	3	1	115	5	1	4	190	5	5	1
41	5	2	1	116	2	4	6	191	5	6	6	41	4	3	6	116	5	1	3	191	5	5	6
42	6	2	1	117	3	4	6	192	6	6	6	42	4	3	5	117	5	1	2	192	5	5	5
43	1	2	6	118	4	4	6	193	1	6	5	43	5	3	4	118	5	1	1	193	6	5	4
44	2	2	6	119	5	4	6	194	2	6	5	44	5	3	3	119	5	1	6	194	6	5	3
45	3	2	6	120	6	4	6	195	3	6	5	45	5	3	2	120	5	1	5	195	6	5	2
46	4	2	6	121	1	4	5	196	4	6	5	46	5	3	1	121	6	1	4	196	6	5	1
47	5	2	6	122	2	4	5	197	5	6	5	47	5	3	6	122	6	1	3	197	6	5	6
48	6	2	6	123	3	4	5	198	6	6	5	48	5	3	5	123	6	1	2	198	6	5	5
49	1	2	5	124	4	4	5	199	1	6	4	49	6	3	4	124	6	1	1	199	1	5	4
50	2	2	5	125	5	4	5	200	2	6	4	50	6	3	3	125	6	1	6	200	1	5	3
51	3	2	5	126	6	4	5	201	3	6	4	51	6	3	2	126	6	1	5	201	1	5	2
52	4	2	5	127	1	4	4	202	4	6	4	52	6	3	1	127	1	1	4	202	1	5	1
53	5	2	5	128	2	4	4	203	5	6	4	53	6	3	6	128	1	1	3	203	1	5	6
54	6	2	5	129	3	4	4	204	6	6	4	54	6	3	5	129	1	1	2	204	1	5	5
55	1	2	4	130	4	4	4	205	1	6	3	55	1	3	4	130	1	1	1	205	2	5	4
56	2	2	4	131	5	4	4	206	2	6	3	56	1	3	3	131	1	1	6	206	2	5	3
57	3	2	4	132	6	4	4	207	3	6	3	57	1	3	2	132	1	1	5	207	2	5	2
58	4	2	4	133	1	4	3	208	4	6	3	58	1	3	1	133	2	1	4	208	2	5	1
59	5	2	4	134	2	4	3	209	5	6	3	59	1	3	6	134	2	1	3	209	2	5	6
60	6	2	4	135	3	4	3	210	6	6	3	60	1	3	5	135	2	1	2	210	2	5	5
61	1	2	3	136	4	4	3	211	1	6	2	61	2	3	4	136	2	1	1	211	3	5	4
62	2	2	3	137	5	4	3	212	2	6	2	62	2	3	3	137	2	1	6	212	3	5	3
63	3	2	3	138	6	4	3	213	3	6	2	63	2	3	2	138	2	1	5	213	3	5	2
64	4	2	3	139	1	4	2	214	4	6	2	64	2	3	1	139	3	1	4	214	3	5	1
65	5	2	3	140	2	4	2	215	5	6	2	65	2	3	6	140	3	1	3	215	3	5	6
66	6	2	3	141	3	4	2	216	6	6	2	66	2	3	5	141	3	1	2	216	3	5	5
67	1	2	2	142	4	4	2					67	3	3	4	142	3	1	1				
68	2	2	2	143	5	4	2					68	3	3	3	143	3	1	6				
69	3	2	2	144	6	4	2					69	3	3	2	144	3	1	5				
70	4	2	2	145	1	5	1					70	3	3	1	145	4	6	4				
71	5	2	2	146	2	5	1					71	3	3	6	146	4	6	3				
72	6	2	2	147	3	5	1					72	3	3	5	147	4	6	2				
73	1	3	1	148	4	5	1					73	4	2	4	148	4	6	1				
74	2	3	1	149	5	5	1					74	4	2	3	149	4	6	6				
75	3	3	1	150	6	5	1					75	4	2	2	150	4						

Contact and Termination Tooling Data

BKA* (LIF) Crimp Contacts

Contact Size and Part Numbers			Crimp Tooling					Insertion/Extraction Tooling			Wire Size			
Size	Part Numbers		Tool P/N		Selec-tor#	Locator P/N		MIL Spec.	ITT Cannon			AWG	Insul Dia. Max	Strip Length
	Pin	Socket	MIL Spec.	ITT Cannon		Mil Spec.	ITT Cannon		Insertion	Extraction	Ins./Ext.			
2222	Used in Plug 030-2259-000	Used in Recep. 031-1287-000	M22520 /2-01	995-0001-584	3 3 4	M22520 /2-23	995-0002-015	M81969 /1-01	CIT-DPXMA-22-1 Metal 070256-0000	CET-DPXMA-22 Metal 070317-0000	980-0004-804 Metal Tip	26 24 22	.054 (1.4)	.130/.110 (3.3)/(2.8)
2020HD	Used in Recep 030-2273-000	Used in Plug 031-1302-000	M22520 /2-01	995-0001-584	6 7	M22520 /2-08	995-0001-604	M81969 /1-02	-	-	980-0004-805 Metal Tip	22 20	.071 (1.8)	.167/.147 (4.2)/(3.7)
1616	Used in Recep 030-2280-000	Used in Plug 031-1303-000	M22520 /1-01	995-0001-585	4 5 6	M22520 /1-02	995-0001-736	M81969 /1-03	-	CET 16-9 Plastic	980-0004-806 Metal Tip	20 18 16	.103 (2.6)	.207/.230 (6.9)/(5.8)
1212	Used in Recep 030-2286-000	Used in Plug 031-1308-000	M22520 /1-01	995-0001-585	7 8	M22520 /1-11	995-0002-027	M81969 /14-04	-	CET 12-4 Plastic	CIET-12 Plastic	14 12	.135 (3.4)	.270/.230 (6.9)/(5.8)

BKA* Thermocouple Contacts

Contact Size and Part Numbers			Crimp Tooling					Insertion/Extraction Tooling			Wire Size			
Size	Part Number		Tool P/N		Selec-tor#	Locator P/N		MIL Spec.	ITT Cannon			AWG	Insul Dia. Max	Strip Length
	Pin	Socket	MIL Spec.	ITT Cannon		Mil Spec.	ITT Cannon		Insertion	Extraction	Ins./Ext.			
2222 Alumel	Used in Plug 030-1975-009	Used in Recep. 031-1113-009	M22520 /2-01	995-0001 584	3	M22520 /2-23	995-0002-015	M81969 /1-01	CIT-DPXMA-22-1 Metal 070256-0000	CET-DPXMA-22 Metal 070317-0000	980-0004-804 Metal Tip	26 24 22	.054 (1.4)	.130/.110 (3.3)/(2.8)
2222 Chromel	Used in Plug 030-1975-010	Used in Recep. 031-1113-010			4									

BKAF-ARINC 600 Size 22 Wrap Post Socket Contacts With .025(6.35) Square Wire-Wrappable Tails-Receptacle Only.

The new low insertion force, front-insertable, front-removable #22 socket contacts with .025(6.35) square wire wrappable tails are now available for use in the BKAF non-environmental receptacle version only. These contacts can be sold separately or they can be supplied with a connector (see How to Order). Use part numbers shown in the table on the right when ordering separately.

Contact Mod.	Part Number	Number of Wraps	Min. Post Extension	Extraction Tool
WA	031-1351-000	1	.250 (6.35)	CET-BKAF 22S
WB	031-1351-001	2	.375 (9.52)	
WC	031-1351-002	3	.500 (12.70)	
WD	031-1351-003	3	.641 (16.28)	

BKAF Printed Circuit Solder Post Socket Contacts Size 22 with .025(6.35) Dia. Printed Circuit Tails-Receptacle Only.

The new low insertion force, front-insertable, front-removable #22 socket contacts with .025(6.35) dia., PC tails are now available for use in the BKAF non-environmental receptacle version only. These contacts can be sold separately or they can be supplied with a connector (see How to Order). Use part numbers shown in the table on the right when ordering separately.

Contact Mod.	Part Number	Min. Post Extension	Extraction Tool
SA	031-1352-000	.150 (3.81)	CET-BKAF 22S
SB	031-1352-001	.250 (6.35)	
SC	031-1351-002	.375 (9.52)	
SD	031-1352-003	.500 (12.70)	

BKAD/F Solder Post, Power Pin Contacts (Captive)-Receptacle Only.

Contacts are captivated between two unbonded insulator halves.

Contact Size	Part Number	Post Dia.	Min. Post Extension*
2D HD	030-2358-000	.032 (0.81)	.150 (3.81)
16	030-2357-000	.050 (1.27)	.150 (3.81)
12	030-2356-000	.081 (2.06)	.150 (3.81)

*Consult factory for other available lengths

BKAF Solder Post Pin Contact Front Release

Contact Size	Part Number	Post Dia.	Min. Post Extension	Extraction Tool
20HD	030-3287-000	.030 (0.76)	.300* (7.62)	317-1798-00
16HD	030-3287-001	.050 (1.27)	.300* (7.62)	317-1798-02
12HD	030-3287-002	.081 (2.06)	.300* (7.62)	317-1798-02

*Applies to BKAF 13W2 and 5W2 inserts only

Front Release Pin Contacts Size 20 and 16

Contact Size	Part Number	PC Tail Dia.	Min. Post Extension
20	030-3296-001	.034 (0.86)/.030 (0.76)	.260 (6.60)
20	030-3296-002	.034 (0.86)/.030 (0.76)	.385 (9.78)
16	030-3297-001	.052 (1.32)/.048 (1.22)	.260 (6.60)
16	030-3297-002	.052 (1.32)/.048 (1.22)	.385 (9.78)
16	030-3297-005	.052 (1.32)/.048 (1.22)	.300 (7.62)
20	030-3296-004	.034 (0.86)/.030 (0.76)	.300 (7.62)

Size 5 Coax Contact (Rear insertable/removable)

Crimp Center Contact-Conforming to ARINC 600

Cable Accommodation	Part Number Pin (Receptacle Connector) Socket (Plug Connector)		Crimp Tooling							Extraction Tool
			Center Contact				Outer Shell			
			Tool		Locator		MIL STD		ITT Cannon	
MIL Spec	ITT Cannon	Daniels	ITT Cannon	Frame	Jaw	Complete Tool				
RG-58C/U BA-5903 (BG)	349-0014-000	349-0013-000	M22520/2-01	995-0001-584	K-345	995-0002-049	M22520/5-01	M22520/5-45B	CCT-HX3-156	CET-C8
5021K1011 (Raychem)	349-0016-000	349-0015-000	M22520/2-01	995-0001-584	K-345	995-0002-049	M22520/5-01	M22520/5-45B	CCT-HX3-156	CET-C8
RG-223	349-1060-100	349-1059-000	M22250/2-01	995-0001-584	K-345	995-0002-049	M22520/5-01	M22520/5-45B	CCT-HX3-156	CET-C8
RG-400	-	349-1003-000	M22250/2-01	995-0001-584	K-345	995-0002-049	M22520/10-01	M22520/10-23	-	CET-C8
RG-316	-	349-1004-000	M22250/2-01	995-0001-584	K-345	995-0002-049	M22520/10-01	M22520/10-23	-	CET-C8

Size 12 Shielded Contact (Rear insertable/removable)

Cable Accommodation	Part Number Pin (Receptacle Connector) Socket (Plug Connector)		Crimp Tooling								Tool MIL Spec ITT Cannon	
			Center Contact				Outer Shell Tool					
			Tool P/N		Locator P/N		MIL Std		ITT Cannon			
			MIL Spec	ITT Cannon	Daniels	ITT Cannon	Frame	Jaw				
RG-196A/U	249-1767-000	-	M22520/2-01	995-0001-584	K-182	995-0002-051	M22520/1-01	M22520/10-05A	995-0001-071	M81969/28-02	CET-12-4 Plastic	
5071 (HW)	249-1767-001	-	M22520/2-01	995-0001-584	K-182	995-0002-051	M22520/1-01	M22520/10-05A	995-0001-071	M81969/28-02	CET-12-4 Plastic	
RG-174/U	-	249-1768-000	M22520/2-01	995-0001-584	K-182	995-0002-051	M22520/1-01	M22520/10-05A	995-0001-071	M81969/28-02	CET-12-4 Plastic	
BMS-1348 (BG)	-	249-2203-000	M22520/2-01	995-0001-584	K-644	995-0002-050	M22520/1-01	M22520/10-05A	995-0001-071	M81969/28-02	CET-12-4 Plastic	

Size 1 Modified Coaxial Contacts (4W4 Layout Only)**Plug Connector**

Cable Accommodation	Part Number	Coax	Style	Replacement Termination Kits	
				Solder Type	Crimp Type
RG214	349-1043-001		Straight	320-1066-000	320-1066-016
AA-5886	349-1048-000		Straight	320-1066-002	320-1066-018
RG393	349-1051-000		Straight	320-1066-003	320-1066-019
ECS 311201	349-1046-000		Straight	320-1066-001	320-1066-017
AA-5887	349-1049-000		Straight	320-1066-004	320-1066-013
AA-5888	349-1050-000		Straight	320-1066-005	320-1066-014
RG142	349-1047-000		Straight	320-1066-006	320-1066-015
Various	349-1047-001		TNC Adapter	-	-

Customer Use Drawings:

All Coax contacts (except 349-1047-001) customer use drawing #349-0000-305

Crimp termination kits: Customer use drawing #320-0000-305

Solder termination kits: Customer use drawing #320-0000-304

Receptacle Connector

Cable Accommodation	Part Number	Coax	Style	Replacement Termination Kits	
				Solder Type	Crimp Type
RG316 DS	349-1051-002		Straight	320-1066-008	N/A
RG142	349-1044-000		Straight	320-1066-007	N/A
Various	349-1042-000		SMA Adapter	-	-

Customer Use Drawings:

Coax contacts 349-1051-002 and 349-1044-000 are located on customer use drawing #349-0000-304

Coax contacts 349-1042-000 is located on customer use drawing #320-1042-000

Sizes 1 Coax Contacts (71W1 layout only)

Same standard coax contacts as used in ITT Cannon's DPX (ARINC 404) connector series.

Receptacle Connector

Cable Accommodation	Coax Part Number	Style	Replacement Coax Termination Kit	Replacement Coax Body Assembly
RG-9/U RG-214/U	249-1521-000		249-1521-002	021-0144-000
NSA 935354 NSA 935355	-		249-2201-000	
RG-55/U RG-58/U RG-142/U RG-400/U	249-1554-000	Straight	249-1554-002	021-0144-003
RG-58/U RG-142/U RG-225/U	249-1604-001	90°	249-1604-003	021-0144-006
RG-402/U UT-141	249-1604-002			
RG-402/U UT-141	249-5027-008	Straight	249-5027-016	021-0144-001
SMA Jack Termination	249-5027-017	Straight	-	-

Plug Connector

Cable Accommodation	Coax Part Number	Style	Replacement Coax Termination Kit	Replacement Coax Body Assembly
RG-9/U	249-1522-000	Straight	249-1522-002	021-0144-004
NSA 935354 NSA 935355	-		249-2202-000	
RG-58/U RG-142/U	249-1882-000			
RG-402/U	249-1885-002	Straight	320-0051-000	021-0144-011
RG-214/U	249-5123-000	Straight	249-5027-013	021-0144-008
RG-115/U	249-5123-001		249-5027-015	

Sizes 1 Coax Contacts (To be used with connectors containing 71W1A, 71W1B and 2W2 insert modifier-"M")

Designed to be interchangeable with contacts made by other manufacturers.

Receptacle Connector

Cable Accommodation	Part Number	Style
RG-142B/U	349-0021-000	Right Angle
RG-402/U UT-141	349-0022-000	Right Angle
SMA Jack Termination	349-0023-000	Straight
RG-214/U RG-393/U BA-6903 (BG)	349-0002-000	Straight
5012H3012 (Raychem)	349-0004-000	Straight
RG-142B/U	349-0006-000	Straight
RG-402/U UT-141	349-0008-000	Straight

Plug Connector

Cable Accommodation	Standard Size 1 Part Number	Modular Size 1 Part Number	Termination Kit for Modular Size 1 Coax	Style
RG-214/U	349-0017-000	349-1053-003	320-1066-000	
RG-393/U	349-0017-000	-	-	Straight
BA-6903	349-0017-000	349-1053-007	320-1066-003	
5012H3012 (Raychem)	349-0018-000	-	-	Straight
RG-142B/U	349-0005-000	349-1053-006	320-1066-006	Straight
RG-402/U UT-141	349-0007-000	-	-	Straight
AA-5888	-	349-1053-008	320-1066-005	Straight
ECS-310801	-	349-1053-005	-	Straight
AA-5886	-	349-1053-004	320-1066-002	Straight
BSX-7004-502	-	349-1053-003	-	Straight
ECS-311201	-	349-1053-002	320-1066-001	Straight
AA-5887	-	349-1053-001	320-1066-004	Straight
Adam Russell PC-38	-	349-1053-000	-	Straight

Size 8 Coaxial Contacts

Plug Connector

Contact Type Socket Part Number	*Engagement		**Termination				RF Cable Number
	Short	Long	Crimp RR-RR	Crimp FR-RR	Solder .250 (6.35)	FR-FR .375 (9.52)	
349-1087-000	-	-	X				Adams-Russell Co. Inc. FC11Z
349-1087-001	-	-	X				Adams-Russell Co. Inc. FC14Z

Receptacle Connector

Contact Type Socket Part Number	*Engagement		**Termination				RF Cable Number
	Short	Long	Crimp RR-RR	Crimp FR-RR	FR-FR .250 (6.35)	Solder .375 (9.52)	
349-1084-000	-	X			X		
349-1084-001	X	-			X		
349-1084-002	-	X				X	
349-1084-003	X	-				X	
349-1086-000	-	X		X			Adams-Russell Co. Inc. FC11Z
349-1086-001	-	X		X			Adams-Russell Co. Inc. FC14Z

Size 8 Twinax Contacts

Plug Connector

Contact Type Socket Part Number	*Engagement		**Termination				RF Cable Number
	Short	Long	Crimp RR-RR	Crimp FR-RR	Solder .250 (6.35)	FR-FR .375 (9.52)	
349-1006-000	-	-	X				M17/176-00002
349-1081-000	-	-	X				Tensolite Co. 24463/9 B017X-2 (LD)

Receptacle Connector

Contact Type Socket Part Number	*Engagement		**Termination				RF Cable Number
	Short	Long	Crimp RR-RR	Crimp FR-RR	Solder .250 (6.35)	FR-FR .375 (9.52)	
349-1007-000	-	-	X				M17/176-00002
349-1080-000	X	-			X		
349-1080-001	-	X			X		
349-1080-002	X	-				X	
349-1080-003	-	X				X	
349-1082-000	X	-		X			Tensolite Co. 24463/9 B017X-2 (LD)
349-1082-001	-	X		X			Tensolite Co. 24463/9 B017X-2 (LD)
349-1088-000	-	X	X				Tensolite Co. 24463/9 B017X-2 (LD)

Size 8 Ground Contacts

Plug Connector

Contact Type Socket Part Number	*Engagement		**Termination				Wire Size
	Short	Long	Crimp RR-RR	Crimp FR-RR	Solder .250 (6.35)	FR-FR .375 (9.52)	
031-3300-000	-	-	X				8, 10 AWG

Receptacle Connector

Contact Type Socket Part Number	*Engagement		**Termination				Wire Size
	Short	Long	Crimp RR-RR	Crimp FR-RR	Solder .250 (6.35)	FR-FR .375 (9.52)	
030-3306-000	-	X			X		8, 10 AWG
030-3306-001	-	X				X	8, 10 AWG
030-3676-000	-	-		X			8, 10 AWG

* The electrical engagement of "Long" contacts is .150 (3.81) greater than the electrical engagement of "Short" contact.

**RR-RR indicates rear release, rear removal.

FR-RR indicates front release, rear removal.

FR-FR indicates front release, front removal.

Sealing Plugs-BKAE Environmental Connectors Only

P/N 225-0090-000
Material: Teflon
(All others thermoplastic)

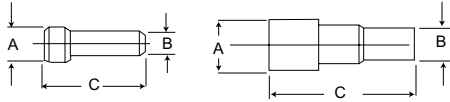

Part Number	Contact Size	Color	A	B	C
225-1013-000	22	Black	.063 (1.6)	.040 (1.0)	.469 (11.9)
225-0070-000	20	Red	.085 (2.2)	.065 (1.6)	.469 (11.9)
225-0071-000	16	Blue	.115 (2.9)	.075 (1.9)	.469 (11.9)
225-0072-000	12	Yellow	.171 (4.3)	.121 (3.1)	.564 (14.3)
225-0090-000	#5 and #9 Coax	White	.365 (9.3)	.287 (7.3)	.835 (21.2)

Filler Plugs-BKAD Non-Environmental Connectors Only

P/N 225-0099-000
Material: Teflon
(All others thermoplastic)

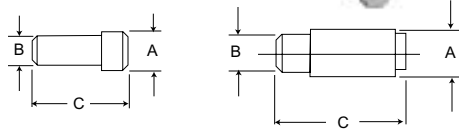

Part Number	Contact Size	Color	A	B	C
225-0094-000	22	Black	.069 (1.7)	.051 (1.3)	.420 (10.7)
225-0095-000	20	Red	.083 (2.1)	.069 (1.7)	.350 (8.9)
225-0096-000	16	Blue	.131 (3.3)	.108 (2.7)	.320 (8.1)
225-0097-000	12	Yellow	.187 (4.7)	.156 (4.0)	.320 (8.1)
225-0098-000	#5 Coax (Pin)	White	.275 (7.0)	.251 (6.4)	.450 (11.4)
225-0099-000	#5 and #9 Coax (Socket)	White	.275 (7.0)	.251 (6.4)	1.061 (26.9)

BKAF P/N 225-1058-000
(Size 22 - Black)
(See Customer Use Drawing for details)

Cavity Reducer



Pin
P/N 021-8756-000



Socket
P/N 021-8757-000

#5 Coax to #12 Contact

Cavity reducers are available when additional circuits are required for size 12 power contacts. These reducers, having the internal configuration of size 12 power contact, are inserted into the size 5 coaxial insulator cavity to create size 12 power contact cavity.

Dust Caps

Conductive dust caps protect against static electricity.



Part Number	Description	Part Number	Description
025-1121-001	BKAD 1-A & B-Plug	025-1155-001	BKAD 1-A&B-Receptacle
025-1122-001	BKAD 1-C-Plug	025-1156-001	BKAD 1-C-Receptacle
025-1123-001	BKAD 2&3-A & B-Plug	025-1157-001	BKAD 2&3-A & B-Receptacle
025-1124-001	BKAD 2&3-C-Plug	025-1158-001	BKAD 2&3-C-Receptacle

Note: Supplied as standard for BKA product line only.

Replaceable Inserts

Layout	Class	Part Number	
		Pin Assembly	Socket Assembly
2W2**	BKAD	144-2944-000	144-2945-000
	BKAE	144-2944-000	144-2945-000
A	BKAE	143-1156-001	143-1157-001
4W4**	BKAD	177-1000-002	177-1001-004
	BKAE	177-1000-002	177-1001-004
5W2	BKAD	143-1912-000	143-1913-000
	BKAE	143-1912-001	143-1913-001
	BKAF	143-1141-000	N/A
6	BKAE	143-1154-001	143-1155-001
6T6	BKAD	228-1026-002	228-1012-003
	BKAE	228-1026-001	228-1012-001
	BKAF	N/A	228-1015-001
10T10	BKAD	228-1027-002	N/A
	BKAE	228-1027-001	228-1014-002
13W2	BKAD	143-1908-000	143-1909-000
	BKAE	143-1908-001	143-1909-001
	BKAF	143-1142-000	N/A
30T2	BKAD	143-1173-000	143-1174-000
	BKAE	143-1173-001	143-1174-001
34	BKAD	143-1159-001	N/A
	BKAE	143-1097-005	143-1098-005
40	BKAE	143-1171-001	143-1172-001
59*	BKAE	143-1167-001	143-1170-001
60-#20**	BKAE	143-3714-003	143-3715-003
60-#22**	BKAD	143-1910-000	143-1911-000
	BKAE	143-1910-001	143-1911-001
	BKAF	N/A	143-2065-000
71W1	BKAD	143-1958-000	143-1960-000
	BKAE	143-1958-002	143-1960-002
	BKAF	N/A	143-2090-000
71W1A*	BKAD	143-2085-001	143-2086-001
	BKAE	143-2085-000	143-2086-000
	BKAF	N/A	143-2066-000
71W1B	BKAD	143-1113-000	143-1111-000
	BKAE	143-114-000	143-1112-000
	BKAF	N/A	143-1118-000
85	BKAD	143-3877-000	143-3878-000
	BKAE	143-3879-000	143-3880-000
	BKAF	N/A	143-1178-000
100	BKAD	143-2015-000	143-2016-000
	BKAE	143-2015-001	143-2016-001
	BKAF	N/A	143-2067-000
110	BKAE	143-1182-000	143-1183-000
120T2	BKAD	N/A	143-1166-002
	BKAE	143-1165-001	143-1166-001
	BKAF	N/A	143-1177-000
121	BKAD	143-1150-002	143-1158-002
	BKAE	143-1150-001	143-1158-001
150	BKAD	143-1906-000	143-1907-000
	BKAE	143-1906-001	143-1907-001
	BKAF	N/A	143-2068-000

Consult factory for Insert Part Numbers not listed.

*Modified 71W1 insert to be used with connectors containing 71W1 insert modifier "M"

**Pin Inserts' accept receptacle coax contacts. "Socket Inserts" accept plug coax contacts.

ARINC 600 Connector Engaging Sequence

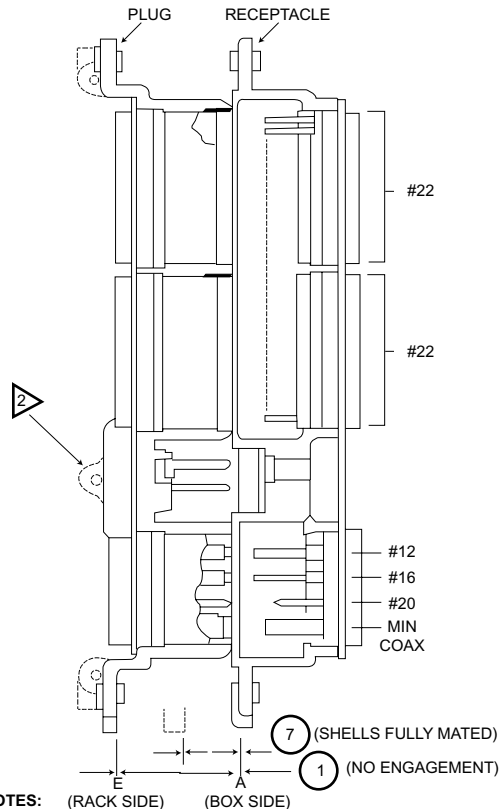

NOTES: (RACK SIDE) (BOX SIDE)

1. Varies; See Mil-Spec. (#5 Coax)
2. Size 1 only.
3. Flush head screws are not permitted for connector mounting as they would position connector incorrectly.
4. Dimension 7 was calculated to provide clearance for
 - MCU backplate mat'l thickness of 2.5 mm (.10 in).
 - Rack backplate mat'l thickness of 2.5 mm (.10 in).
 - Connector mounting pan head screws, MCU 2.0 mm (.08 in).
 - Tolerance allowance - 3.2 mm (.13 in.) rack 2.0 mm (.08 in.)
 Total - 12.2 (.50 in) (minimum).

Mating Sequence	Flange Position With:	Flange Spacing in. (mm)
①	No Engagement	1.245 (31.62) Nom.
②	Shells Initially Engaged	1.110 (28.19) 1.073 (27.25)
③	Polarizing Pins Entering Keys	1.073 (27.25) 1.023 (25.88)
	Contacts Entering Mating Insulator	
	#22	.800 (22.32) .748 (18.99)
④	#20	.805 (20.44) .741 (18.82)
	#16	1.012 (25.70) .949 (24.10)
	#12	1.008 (23.60) .953 (24.20)
	Miniature Coax	①
	Contacts Electrically Engaged	
	#22	.642 (16.30) .547 (13.89)
⑤	#20	.649 (16.48) .553 (14.04)
	#16	.728 (18.49) .818 (20.77)
	#12	.772 (19.60) .692 (17.57)
	Miniature Coax	①
⑥	"0" Ring Engagement (BKAE Only)	.618 (15.70) .578 (14.68)
⑦	Shells Fully Mated	.522 (13.26) .488 (12.40)

- Available Rear Release/Rear Removable Front Release/Front Removable
- Low Insertion force contacts.
- Both environmental and non-environmental versions.
- Polarizing post that are removable from the mating face.
- Field replaceable inserts.
- Up to 150 Size #22 contacts per connector.
- Crimp, coax, twinax, printed circuit and wire wrappable post style contacts.
- Uses standard ARINC 600, crimp, insertion/ extraction tooling.



SGA connectors utilize all the Signal cavity inserts and contacts from the ARINC 600 connector series. It was designed to be used where there are space constraints in which a standard ARINC 600 connector can not be used. ITT Cannon's SGA connector fills the need for a 150 maximum contact connector with a smaller shell design than Shell Size 2 of ARINC 600, and has more contacts available than single gang DPX with 106 Size 22 contacts.

Materials and Finishes

		SGA*D	SGA*E	SGA*F	Specifications
Shell	Material	Aluminum alloy	Aluminum alloy	Aluminum alloy	QQ-A-591/A380
	Finish	Clear chromate over cadmium	Clear chromate over cadmium	Clear chromate over cadmium	QQ-P-416
Insulator	Material	Thermoplastic	Thermoplastic	Thermoset	N/A
	Material	Copper alloy	Copper alloy	Copper alloy	QQ-C-533
Contacts	Finish	Gold	Gold	Gold	MIL-G-45204
	Termination	Crimp	Crimp	P.C/Wrap Post	N/A
	Material	N/A	Silicone-based Elastomer	N/A	N/A
O-Ring	Material	N/A	Silicone-based Elastomer	N/A	N/A

How to Order (Refer to ARINC 600 [BKA] pages 13-16 for contact information.)

CONNECTOR SERIES

SGA (Single Gang ARINC 600)

SHELL STYLE

- 3 - Plug (Rack Side)
- 4 - Receptacle (Box Side)

CLASS

- C - Non-environmental with Grommet only, insulators are not potted into the connector shell.
- D - Non-environmental (rear release crimp contacts).
- E - Environmentally sealed (rear release crimp contacts).
- F - Non-environmental (front release, printed circuit or wire wrap posts).
- R - EMI/RFI Protected & Environmentally sealed, 0-ring omitted (plug only). (Reference ITTC Phoenix)

CONTACT ARRANGEMENT

(See ARINC 600 (BKA) contact arrangements, pages 9-10)

CONTACT TYPE

- P - Pin Contacts
- S - Socket Contacts

CONNECTOR MOUNTING MODIFIER

- Mounting modifiers 00, 03, 06, 14, 15, hole location is .705 basic from connector vertical centerline.
- 00 - .151 Dia. Mounting holes.
 - 03 - .156 with #4-40 Self-Locking Clinch Nuts (ESNA #22NCFMA2-40) 4 per connector.
 - 06 - .188 Dia. For #6-32 Clinch nuts (ESNA #12NCFMA2-62) 4 per connector.
 - 14 - .137 Dia., Countersunk 82°x .230 Dia., Engaging face of mounting flange.
 - 15 - .137 Dia., Countersunk 82°x .230 Dia., Engaging face of mounting flange. Supplied with slant shield grounding spring.

CONNECTOR SERIES

SHELL STYLE

CLASS

CONTACT ARRANGEMENT

CONTACT TYPE (PIN OR SOCKET)

CONNECTOR MOUNTING MODIFIER

POLARIZING POSITION

CONTACT MODIFIER

Mounting modifiers 05, 07, 08, 09, 10, 11, 12, 13, hole location is .650 basic from connector vertical centerline.

- 05 - .208 Dia. for Floating Eyelet
- 07 - .212/.204 Slot 4 places.
- 08 - .120 Dia. Countersunk 82°x .230 Dia., Engaging face of mounting flange.
- 09 - .120 Dia. Countersunk 82°x .230 Dia., Rear face of mounting flange.
- 10 - .120 Dia. Countersunk 100°x .230 Dia., Engaging face of mounting flange.
- 11 - .120 Dia. Countersunk 100°x .230 Dia., Rear face of mounting flange.
- 12 - .137 Dia. Countersunk 82°x .230 Dia., Engaging face of mounting flange.
- 13 - .137 Dia. Countersunk 82°x .230 Dia., Rear face of mounting flange.

POLARIZING POSITION

- 01 - 36 Positions. (See Chart page 24)
- When the last two digits are omitted, the polarizing posts will not be assembled and position number is not stamped on the connector. This allows the user to position the post and stamp the appropriate number on the shell. If the last two digits are "00", polarizing posts are not supplied with the connector.

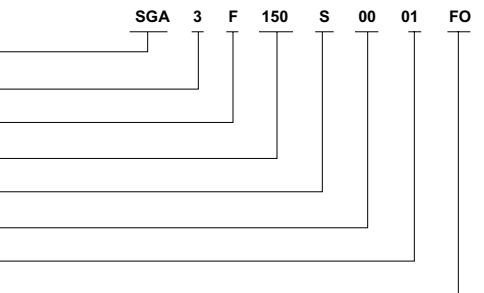

CONTACT MODIFIER

Refer to page 13 for replacement contact part numbers and required termination tooling information. (Blank) - With standard Crimp type Rear release contacts.

- F0 - Contacts are not supplied with connector (FO not stamped on connector.)
- SA - Front release .025 Dia. x .150 Solder Post Size 22 Sockets
- SB - Front release .025 Dia. x .250 Solder Post Size 22 Sockets
- SC - Front release .025 Dia. x .375 Solder Post Size 22 Sockets
- SD - Front release .025 Dia. x .500 Solder Post Size 22 Sockets
- WA - Front release .025 Sq. x .250 (1 Wrap)
- WB - Front release .025 Sq. x .375 (2 Wrap)
- WC - Front release .025 Sq. x .500 (3 Wrap)
- WD - Front release .025 Sq. x .641 (3 Wrap)

Plug Shell Dimensions

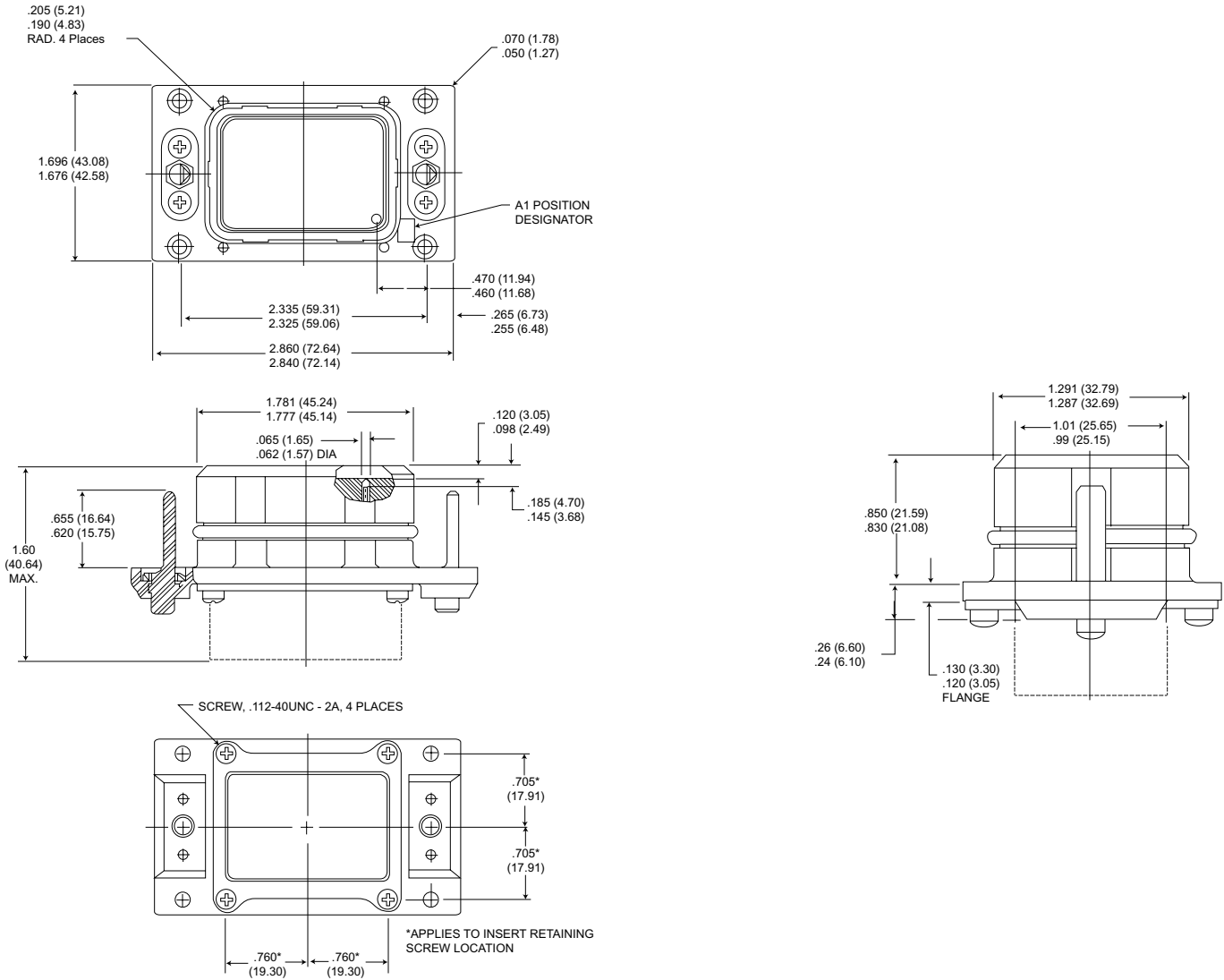

Recommended Panel Cutout

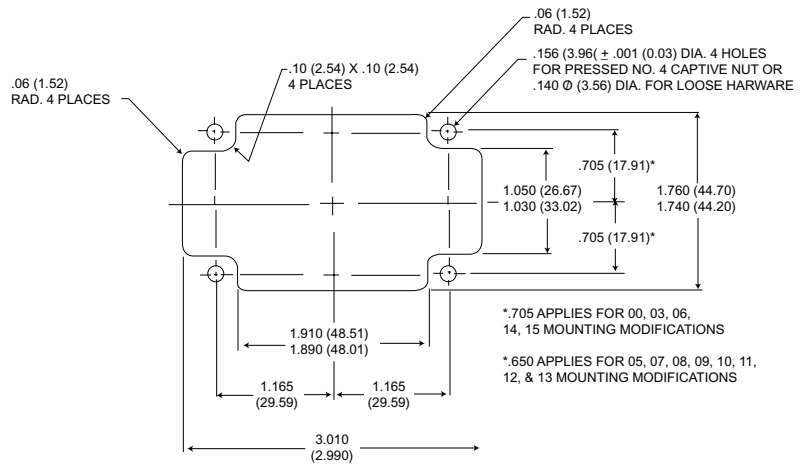

Receptacle Shell Dimensions

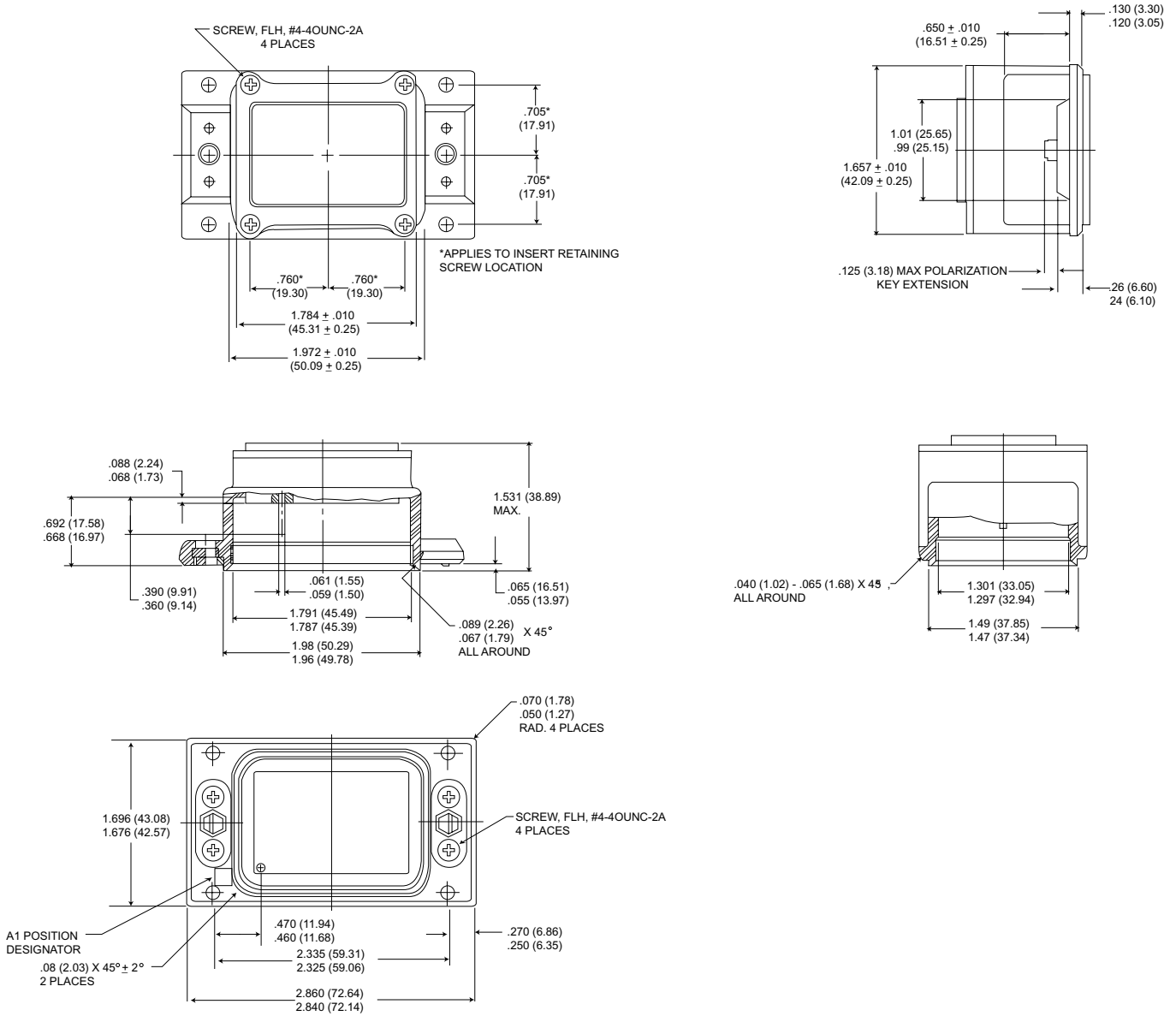

Recommended Panel Cutout

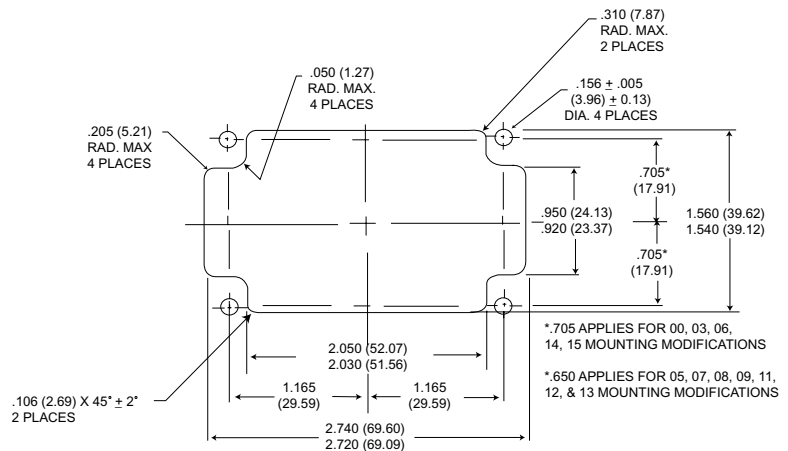

Polarization

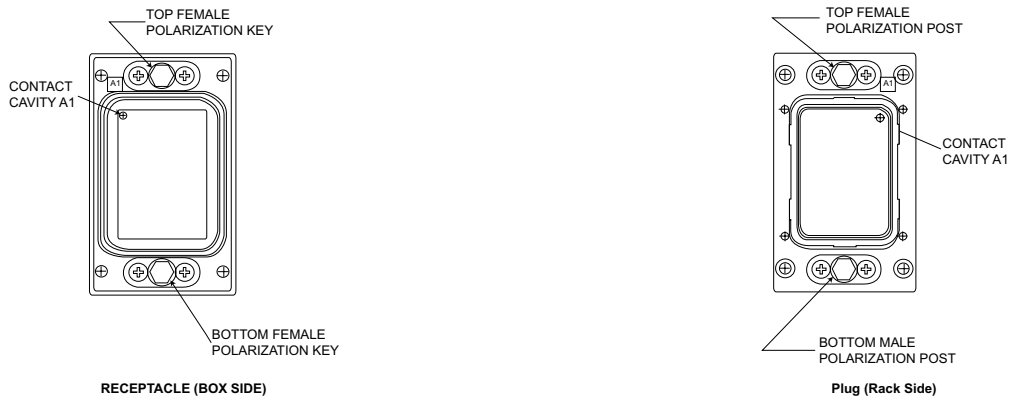

Polarizing Positions

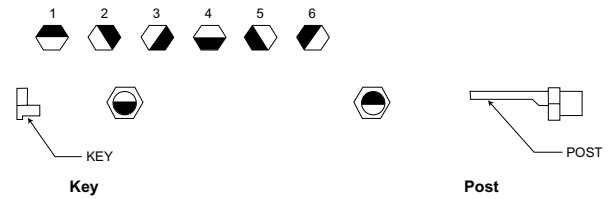

Position	Connector Receptacle		Connector Plug	
	Top Key	Bottom Key	Top Post	Bottom Post
01	1	1	4	4
02	3	4	2	1
03	2	4	3	1
04	1	4	4	1
05	6	4	5	1
06	5	4	6	1
07	4	5	1	6
08	3	5	2	6
09	2	5	3	6
10	1	5	4	6
11	6	5	5	6
12	5	5	6	6
13	4	6	1	5
14	3	6	2	5
15	2	6	3	5
16	1	6	4	5
17	6	6	5	5
18	5	6	6	5
19	4	1	1	4
20	3	1	2	4
21	2	1	3	4
22	4	4	1	1
23	6	1	5	4
24	5	1	6	4
25	4	2	1	3
26	3	2	2	3
27	2	2	3	3
28	1	2	4	3
29	6	2	5	3
30	5	2	6	3
31	4	3	1	2
32	3	3	2	2
33	2	3	3	2
34	1	3	4	2
35	6	3	5	2
36	5	3	6	2

Cannon's DPXNA (non-environmental, Type IV) and DPXNE (environmental, Types II and III) rack and panel connectors are designed to meet or exceed the requirements of MIL-C-81659, Revision B. They are used in military and aerospace applications and computer periphery equipment requirements, and

are designed to operate in temperatures ranging from - 65°C to + 125°C. DPXNA/NE connectors are available in single, 2, 3, and 4 gang configurations, with a total of 12 contact arrangements accommodation contact sizes 12, 16, 20 and 22, and combination standard and coaxial contacts.

Contact retention of these crimp snap-in contacts is provided by the LITTLE CAESAR® rear release contact retention assembly. Environmental sealing is accomplished by wire sealing grommets and interfacial seals.

How to Order

Single Gang

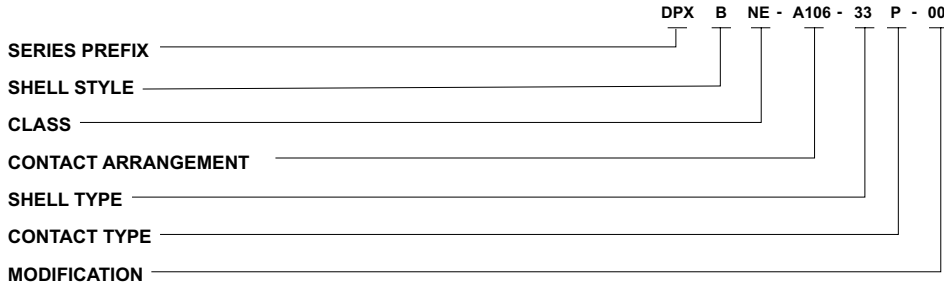

SERIES PREFIX

DPX - ITT Cannon Designation

SHEL STYLE

B - ARINC 'B' Shell

CLASS (MIL-C-81659B, Class 1),...

NA - Non - Environmental (MIL-C-81659B, Type IV)
NE - Environmental (Mil-C-81659B, Types II and III)

INSERT DESIGNATOR

In the 3 and 4 gang assemblies, the insert designation number represents cumulative (total) contacts. The charts on page 26 denote shell cavity location by layout. (If desired arrangement location is not defined, please consult or local sales engineering office.)

CONTACT ARRANGEMENT

See page 31

SHELL TYPE

'33' for Plug; '34' for Receptacle

CONTACT TYPE

'P' for Pin (Standard on '34' receptacle except A106 layout which has reversed contact sex)
'S' for Socket (Standard on '33' plug except A106 layout which has reversed contact sex)

MODIFICATION CODES

- 00 Standard
- 01 Standard with clinch nuts in the mounting holes (34 only).
- 02 Standard with tabs for attaching junction shells.
- 03 Standard with mounting holes .120 dia. countersunk 100° to .230 dia. (.33 only).
- 17 Combination of 01** and 02** (clinch nuts in mounting holes - 34 only and tabs for attaching junction shells).
- 22 Standard with clinch nuts (.33 only).
- 23 Standard with standard floating eyelets.
- 29 Standard except less grommet (NE, pin only).
- 30 Same as - 29** except with tabs for attaching junction shells.
- 33 Same as - 29** except with clinch nuts.
- 37 Same as - 29** except with clinch nuts and tabs for attaching junction shells.
- 39 Standard with standard floating eyelets and tabs for attaching junction shells.

NOTE: For additional modification codes please consult the factory

Two (2) Gang

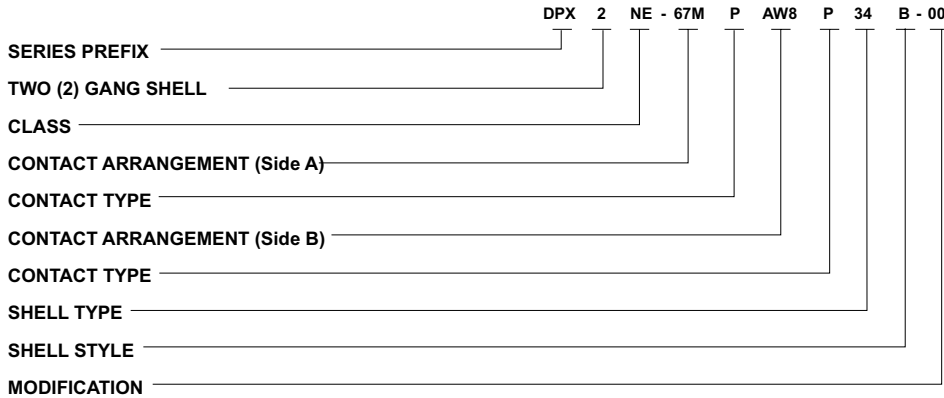

Three (3) Gang

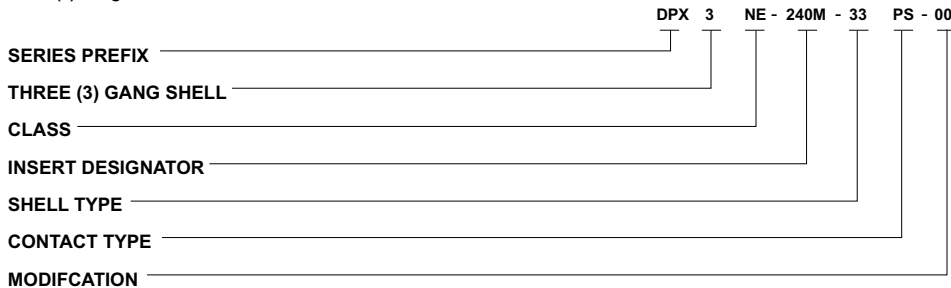

Four (4) Gang

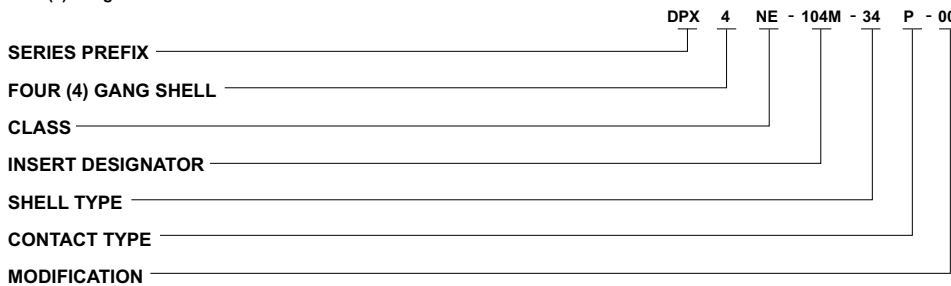

NOTE: On 3 & 4 gang assemblies, combination layouts, the contact type designator of the A106 layout. If applicable, precedes the designator for standard contact sex layouts. See three (3) gang nomenclature breakdown above for 240M example (67MS, 67 MS, A106P).

Insert Designator Number

DPX3NA/DPX3NE										DPX4NA/DPX4NE											
MS3157	ITTC	Side A	Side B	Side C	MS3157	ITTC	Side A	Side B	Side C	MS3157	ITTC	Side A	Side B	Side C	Side D	MS3157	ITTC	Side A	Side B	Side C	Side D
0005	78M	26MP	26MP	26MP	0066	24M	W8MS	W8MS	W8MS	0007	104M	26MP	26MP	26MP	26MP	0063	95M	10W3MP	10W3MP	W8MP	67MP
0006	78M	26MS	26MS	26MS	0067	122M	W8MP	W8MP	A106S	0008	104M	26MS	26MS	26MS	26MS	0064	95M	10W3MS	10W3MS	W8MS	67MS
0013	120M	40MP	40MP	40MP	0068	122M	W8MS	W8MS	A106P	0015	160M	40MP	40MP	40MP	40MP	0085	150M	W8MP	W8MP	67MP	67MP
0014	120M	40MS	40MS	40MS	0073	142M	67MP	67MP	W8MP	0016	160M	40MS	40MS	40MS	40MS	0086	150M	W8MS	W8MS	67MS	67MS
0021	135M	45MP	45MP	45MP	0074	142M	67MS	67MS	W8MS	0023	180M	45MP	45MP	45MP	45MP	0095	326M	A106S	W8MP	A106S	A106S
0022	135M	45MS	45MS	45MS	0075	240M	67MP	67MP	A106S	0024	180M	45MS	45MS	45MS	45MS	0096	326M	A106P	W8MS	A106P	A106P
0029	171M	57MP	57MP	57MP	0076	240M	67MS	67MS	A106P	0031	228M	57MP	57MP	57MP	57MP	0097	287M	A106S	67MP	A106S	W8MP
0030	171M	57MS	57MS	57MS	0079	A240M	67MP	A106S	67MP	0032	228M	57MS	57MS	57MS	57MS	0098	287M	A106P	67MS	A106P	W8MS
0037	201M	67MP	67MP	67MP	0080	A240M	67MS	A106P	67MS	0039	268M	67MP	67MP	67MP	67MP	0099	189M	A106S	67MP	W8MP	W8MP
0038	201M	67MS	67MS	67MS	0091	279M	A106S	A106S	67MP	0040	268M	67MS	67MS	67MS	67MS	0100	189M	A106P	67MS	W8MS	W8MS
0045	A318	A106P	A106P	A106P	0092	279M	A106P	A106P	67MS	0047	A424	A106P	A106P	A106P	A106P	0101	346M	A106S	A106S	67MP	67MP
0046	A318	A106S	A106S	A106S	0157	244M	A106S	A106S	32W4MP	0048	A424	A106S	A106S	A106S	A106S	0102	346M	A106P	A106P	67MS	67MS
0065	24M	W8MP	W8MP	W8MP	0158	244M	A106P	A106P	32W4MS												

Performance and Material Specifications

MATERIALS AND FINISHES

Description	Material	Finish
Shell	Aluminum alloy	Cadmium plating, Type II, Class 3/ QQ-P-416 with yellow chromate finish (underplating may be used)
Insulators	Thermoplastic or thermosetting plastic	None
Elastomers	Silicone rubber (ITT Cannon Blend)	None
Contacts	Copper alloy	Gold plate per MIL-G-45204, Type 1, Grade C, Class 1 with suitable underplating (silver not used)
Insulator Retaining Plate	Aluminum alloy	Anodize, blue color
Junction Shells (Not available for four gang)	Aluminum alloy	Same as shell
Clinch Nuts	Stainless steel	Cadmium Plating
Float Mounts	Stainless Steel	None
Polarizing Posts	Zinc (die cast)	Cadmium plating
Polarizing Keys & Retaining Plate	Nickel Silver	None
Screws	Brass	Cadmium plating
Lockwashers	Phosphor Bronze	Cadmium plating

ELECTRICAL

Contact size	Wire Size	Insulation O.D. Limits (Inch)	Test Current per Mil-C-39029	Max. Current for Tests (Amps) (Mil-C-39029)	Max. Potential Drop (Millivolts) at 25°C
		Max.			
12	12	.135 (3.43)	23.0	23.0	63
	14		17.0	17.0	60
	16		13.0	13.0	68
16	18	.103 (2.62)	-	-	-
	20		7.5	-	75
	20		7.5	7.5	83
20	22	.071 (1.80)	-	-	-
	24		3.0	3.0	68
	22		5.0	5.0	110
22	24	.054 (1.37)	-	-	-
	26		2.0	2.0	80

Note - The maximum contact resistance listed above is with silver plated wire.

Shell Dimensions

DPXB-33

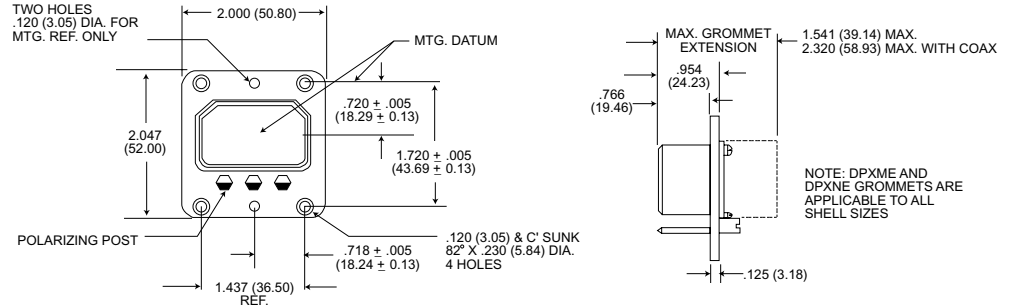

DPXB-34

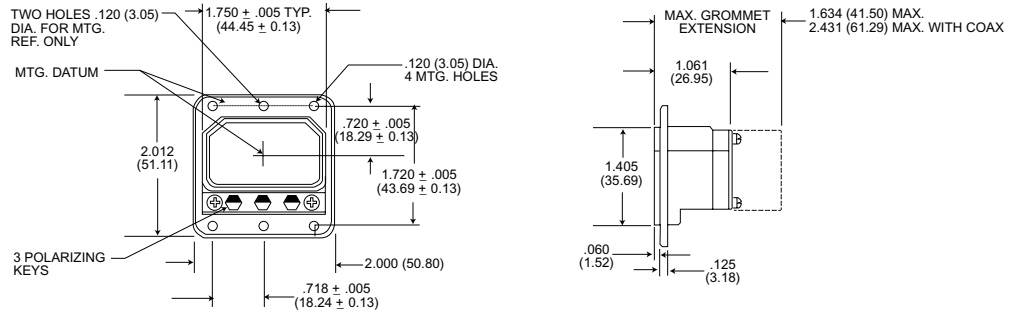

DPX2-33B

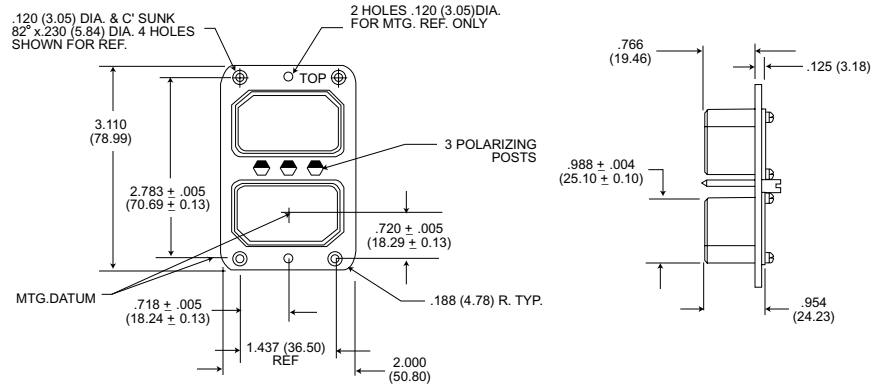

DPX2-34B

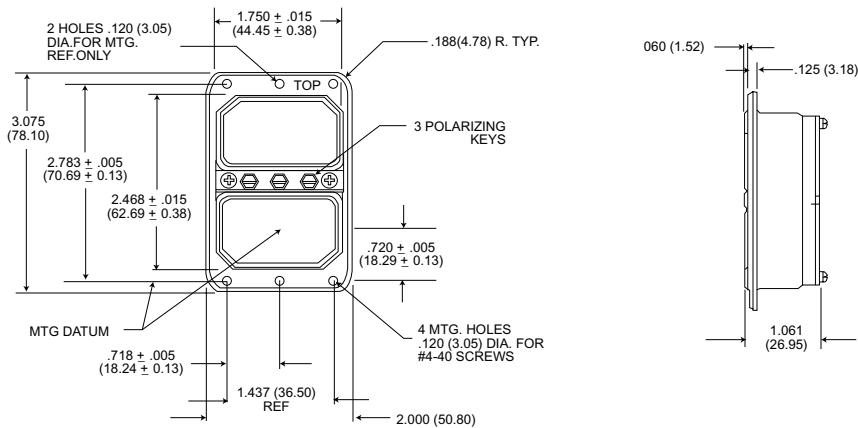

All tolerances ± .015 (0.38) unless otherwise noted.

Shell Dimensions

DPX3-33

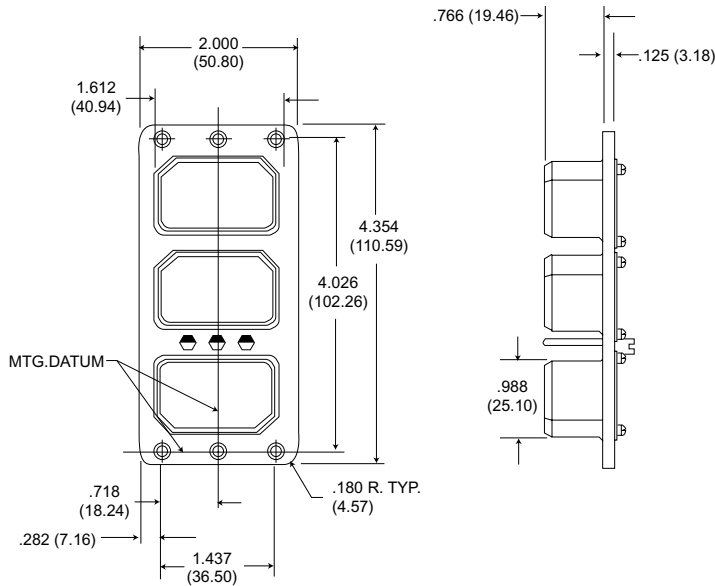

DPX3-34

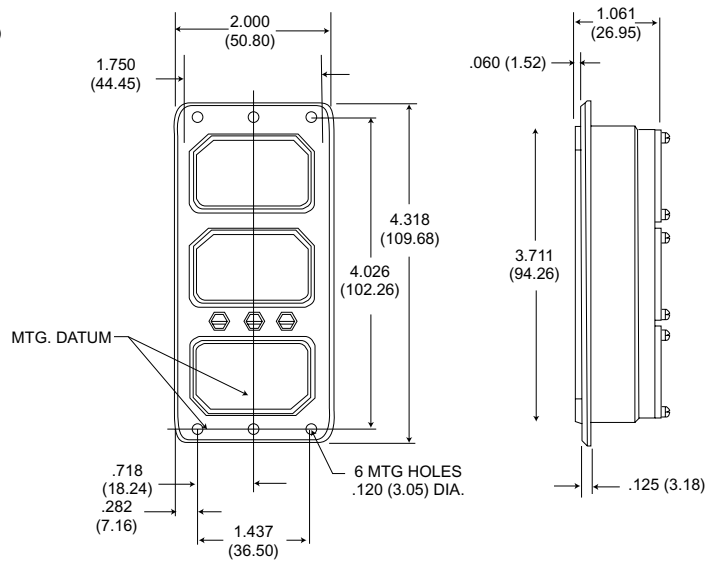

DPX4-33

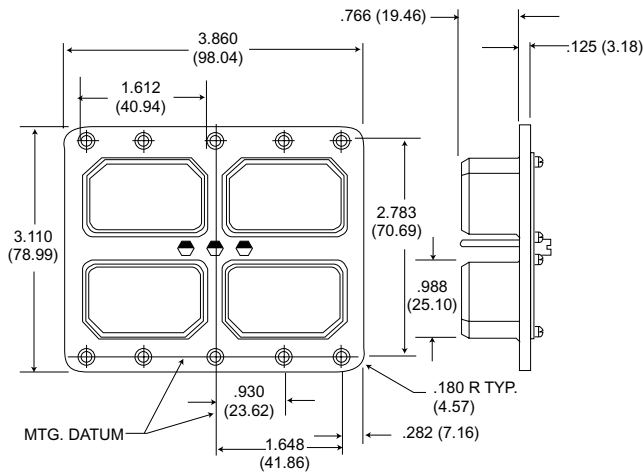

DPX4-34

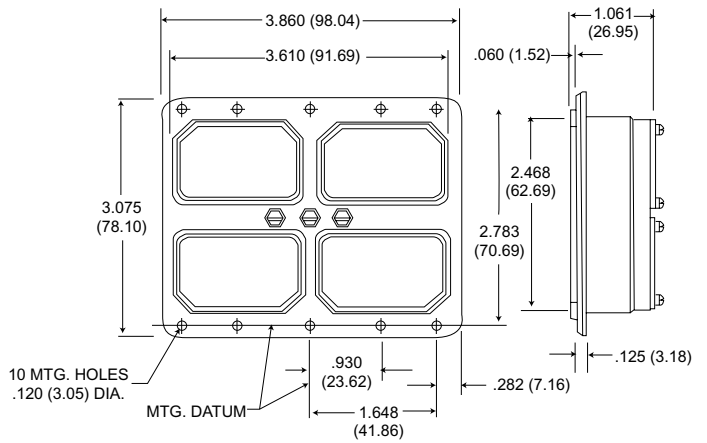

Modification Code

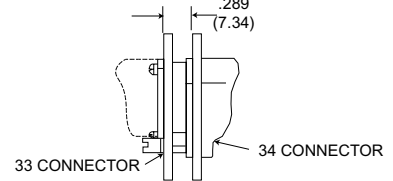
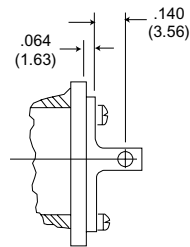
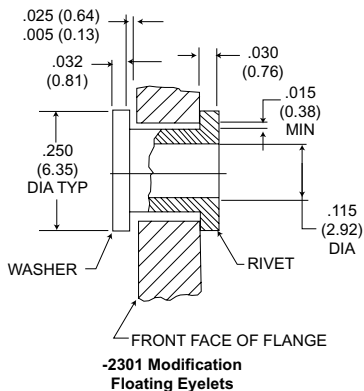

All tolerances ± .015 (0.38) unless otherwise noted.

Panel Cutouts

DPXB

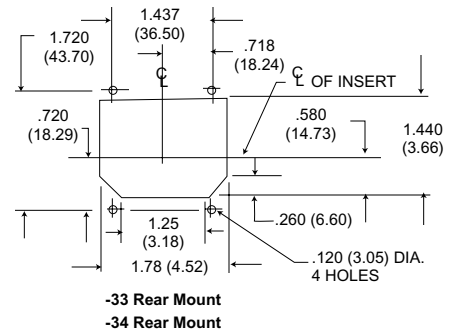
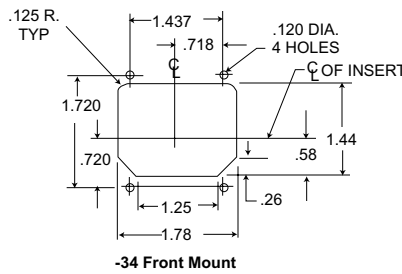
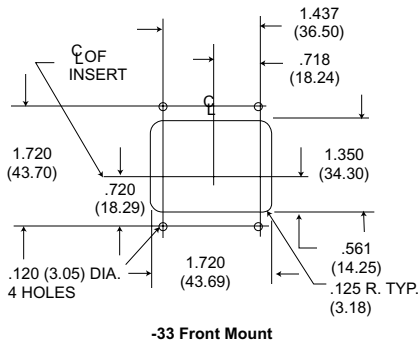

DPX2

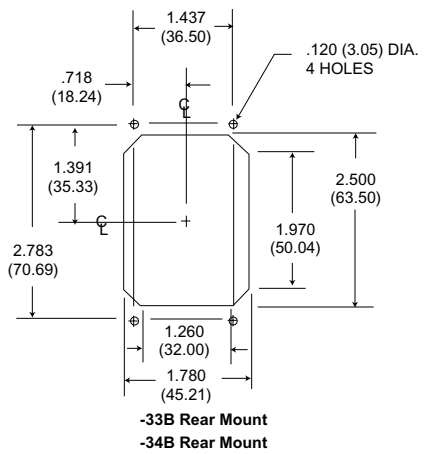
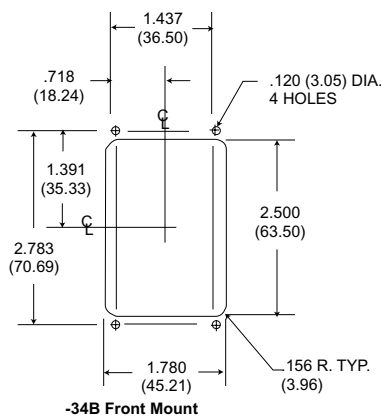
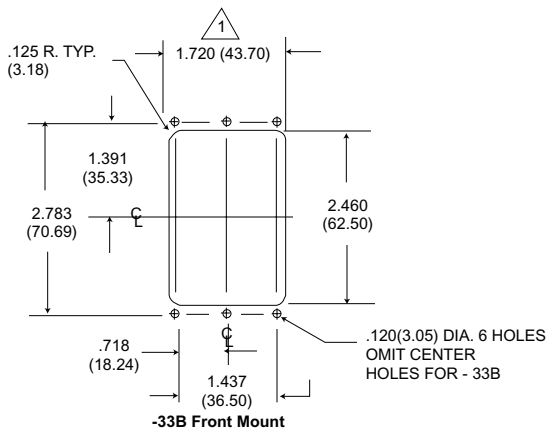

△ For - 23 float mtg. mod. 1.78 (45.21)

DPX3

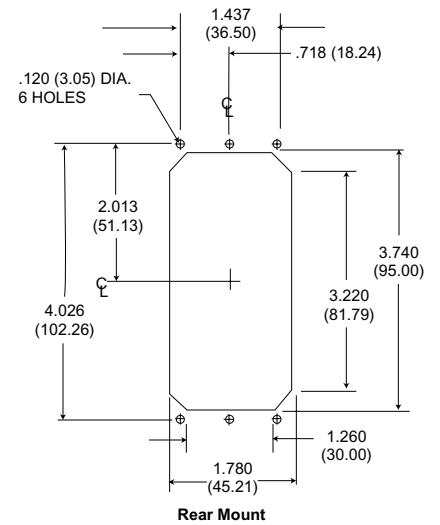
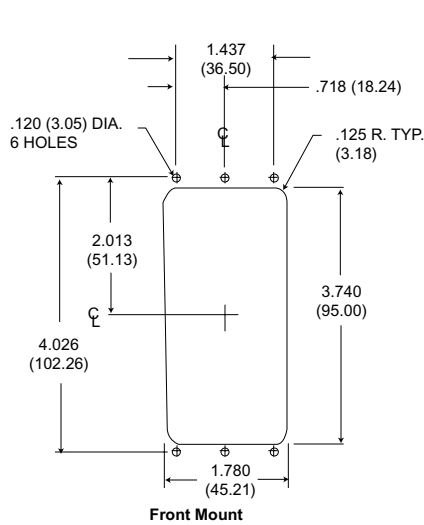

All tolerance ± .015 (0.38) unless other wise noted.

Panel Cutouts (Continued)

DPX4

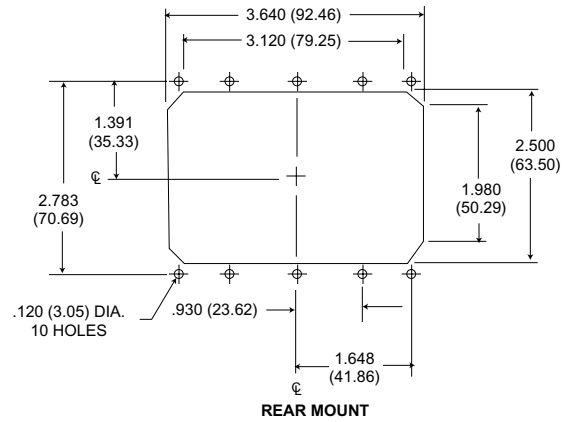
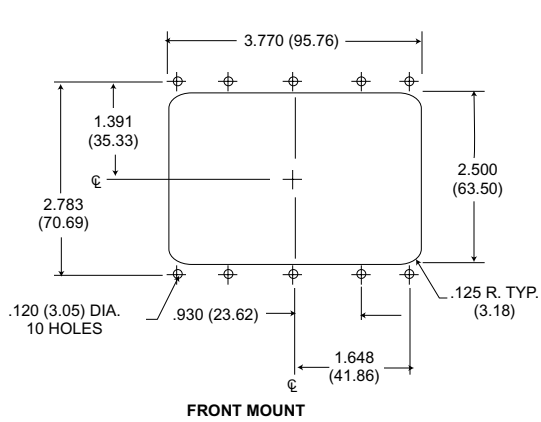

All tolerance $\pm .015$ (0.38) unless otherwise noted.

Contact Arranements

Face View of Pin Insulator Shown.

Cross Reference

MS3157	ITTC
C8	W8M
E8	D8M
10C3	10W3M
26	26M
32C2	32W2M
32C4	32W4M
	33C4M
40	40M
40C1	40W1M
45	45M
57	57M
67	67M
106	A106

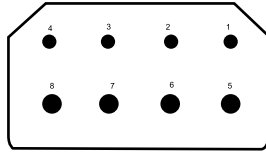

D8M
4 #16, 4 #12
1500

Layout
Contacts
Test Voltage

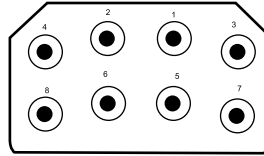

W8M
8 Coaxial*
1000

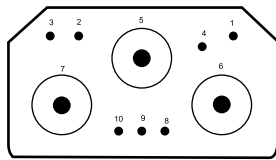

10W3M
7HD #20, 3 Coaxial**
1500
(Coax 1000)

Layout
Contacts
Test Voltage

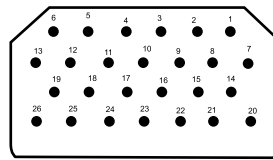

26M
26 #16
1500

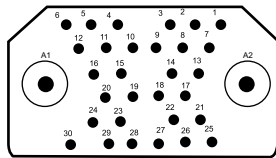

32W2M
30HD #20, 2 Coaxial†
1500
(Coax 1000)

Layout
Contacts
Test Voltage

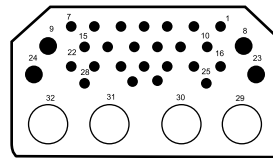

32W4M
24HD #20
4 #16, 4 Coaxial*
1500
(Coax 1000)

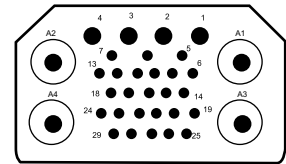

33C4M
25HD #20, 4 Coaxial†
1000

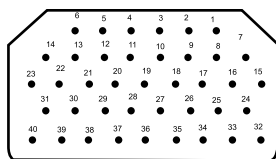

40M
40HD #20
1500

Layout
Contacts
Test Voltage

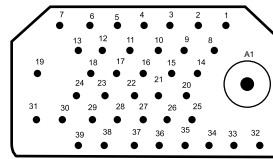

40W1M
39HD #20, 1 COAXIAL†
1500
(COAX 1000)

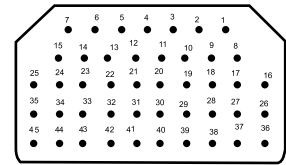

45M
45HD #20
1500

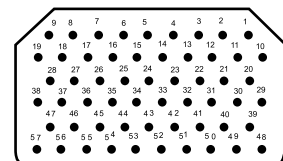

57M
57 HD #20
1500

Layout
Contacts
Test Voltage

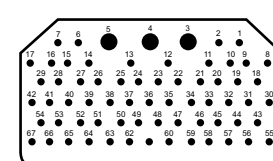

67M
64 HD #20, 3 #16
1000

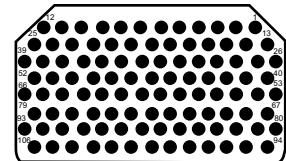

A106
106 #22
1000

*SIZE 9 COAXIAL **SIZE 11 COAXIAL † SIZE 5 COAXIAL

NOTE: All coaxial layouts supplied less coaxial contacts (i.e. W8M, 10W3M, 32W2M, 32W4M, 33C4M, 36W7, 40W1M)

Contact and Termination Tooling Data - Military

Contact Size	DPX*NE/NA		Wire Accom.	Crimp Tool Part Number	Locator Part Number	Insertion/Extraction Tool	Layout Usage DPX*NE/NA
	Pin Part Number (Military Equivalent)	Socket Part Number (Military Equivalent)					
2222	030-1975-008 (M39029/11-144)	031-1113-008 (M39029/12-148)	22, 24, 26	M22520/2-01	M22520/2-23	CIT-DPXMA-22 M81969/1-01	A106
2020HD	030-1892-004 (M39029/11-145)	031-1047-003 (M39029/12-149)	20, 22, 24	M22520/2-01 MS-3191-1	M22520/2-08 Standard	CIT-20 CET-20D-1 M81969/1-02	10W3M, 32W2M, 32W4M, 40M, 40W1M, 45M, 57M, 67M,
1616	030-9083-012 (M39029/11-146)	031-1271-000 (M39029/12-150)	16, 18, 20	M22520/1-01 MS-3191-1	M22520/1-02 Std. Locator	CIET-16	D8M, 26M, 32W4M, 67M
1212	030-1909-002 (M39029/11-147)	031-1059-003 (M39029/12-151)	12, 14	M22520/1-01	M22520/1-11	CIET-12	D8M

*Requires air line pressure of 80 to 100 PSI for CBT-600 and 120 PSI for CBT-600B.

Coaxial Contact Data

Components/Accessories
LITTLE CAESAR® contact retention assembly (W8M, 32W2M, 32W4M & 40W1M contact arrangements)

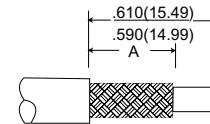

Contact Arrangement	Part Number (P=Pin, S = Socket)			Cable Accommodation†		Ins. Dia. Size/Max.	'A' Trim Dim.	
	Without Seal††		With Seal	Seal 1	Seal 2			
	A152†††	A176†††	A152†††					
(Size 5 Coax)	P-249-2071-000	249-2071-001	249-2101-000	RG180	RG195U	.158 (4.01)	.260(6.60)	
	S-249-2076-000	249-2076-001	249-2106-000				.250(6.35)	
	P-249-2072-000	249-2072-001	249-2102-000	RG58	X	.196 (4.98)	.260(6.60)	
	S-249-2077-000	249-2077-001	249-2107-000				.250(6.35)	
	32W2M	P-249-2073-000	249-2073-001	249-2103-000	RG142	X	.196 (4.98)	.260(6.60)
		S-249-2078-000	249-2078-001	249-2108-000				.250(6.35)
	40W1M	P-249-2074-000	249-2074-001	249-2104-000	RG179	RG174, RG179,	.111 (2.82)	.350(8.89)
		S-249-2079-000	249-2079-001	249-2109-000		RG316		.330(8.38)
	36W7	P-249-2075-000	249-2075-001	249-2105-000	RG178	X	.075 (1.90)	.260(6.60)
		S-249-2080-000	249-2080-001	249-2110-000	RG196			.250(6.35)
(Size 9 Coax)	P-249-2081-000	249-2081-001	249-2111-000	RG180	RG195U	.158 (4.01)	.260(6.60)	
	S-249-2086-000	249-2086-001	249-2116-000				.250(6.35)	
	P-249-2082-000	249-2082-001	249-2112-000	RG58	X	.196 (4.98)	.260(6.60)	
	S-249-2087-000	249-2087-001	249-2117-000				.250(6.35)	
	W8M	P-249-2083-000	249-2083-001	249-2113-000	RG142	X	.196 (4.98)	.260(6.60)
		S-249-2088-000	249-2088-001	249-2118-000				.250(6.35)
	32W4M	P-249-2084-000	249-2084-001	249-2114-000	RG179	RG174, RG179,	.111 (2.82)	.350(8.89)
		S-249-2089-000	249-2089-001	249-2119-000		RG316		.330(8.38)
	P-249-2085-000	249-2085-001	249-2115-000	RG178U	X	.075 (1.90)	.260(6.60)	
	S-249-2090-000	249-2090-001	249-2120-000	RG196U			.250(6.35)	

NOTES: † Coaxials without the seal accommodates both Seal 1 and Seal 2 cables.
 †† Coaxials without the seal are utilized in DPX*NE connectors supplied less the grommet (modification code: - 29**) and DPX*NA connectors.
 ††† A152 modification code indicates .00005 (0.0010) gold plating on coaxial contacts. (Standard for the DPXNE/NA series.)
 A176 modification code indicates .00002 (0.0005) gold plating on coaxial contacts.

Wire Strip Dimensions



Wire Strip Dimension	
	A Dim.
#22	.130/.110(3.30/2.79)
#20HD	.167/.147(4.24/3.73)
#16	.270/.230(6.86/5.84)
#12	.270/.230(6.86/5.84)

Dimensions are shown in inches (millimeters).
Dimensions subject to change.

Coaxial Contact Data

Installation Data

1. Use basic tool M22520/5-01 with Y-211 die (#995-0002-249) for crimping.
2. Use extraction tool No. CET-C8. An insertion tool is not required (See Note 5).
3. Center contact, rear insulator, crimp ring, support bushing (not applicable to RG58/RG142 coaxials), seal sleeve, front insulator, shell and ferrule are shipped unassembled in a common container.

4. Cable Assembly Instructions

- Step 1 - If applicable determine which portion of seal sleeve should be used. If Seal 2 is used, cut off Seal 1 portion.
- Step 2 - In sequence, place seal sleeve, support bushing and crimp ring over cable jacket.
- Step 3 - Trim cable per illustration.
- Step 4 - Comb out braid and flare out ends to permit entry of ferrule.
- Step 5 - Complete termination per illustration.

5. To extract coaxial, push back seal sleeve and support bushing. Slip cable into extraction tool. Push tool into insert until contacts coaxial retaining shoulder. Grip both cable and tool with one hand and pull coaxial rearward out of insert cavity.
6. To facilitate extraction of contacts, the length of free cable adjacent to the rear surface of the connector should not be less than 2.000 (50.80).

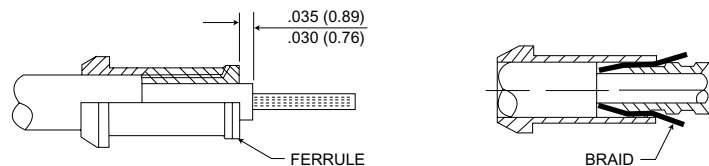
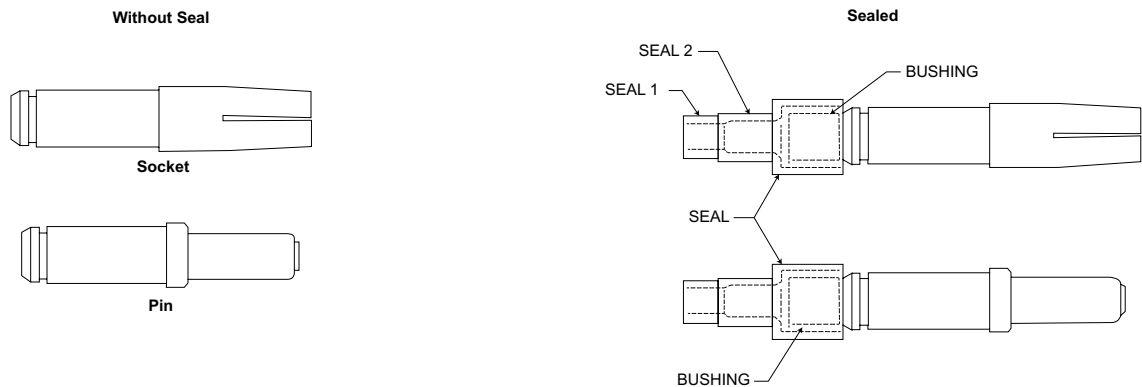

- A. Push ferrule under braid as far as it will go. Trim off braid extending beyond shoulder of ferrule, if necessary.
- B. While holding ferrule in place pull crimp sleeve forward over braid until it is tight against shoulder on ferrule. Pull firmly against face of ferrule to make sure it is up tight.
- C. Trim dielectric to the .035 (0.89)/.030 (0.76) dimension.

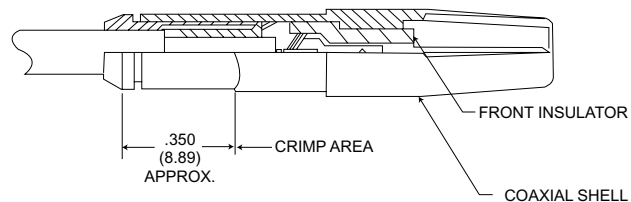

- A. Place front insulator over contact and then push assembly into coaxial shell.
- B. Place parts in jaw of crimp tool. Locate jaws at start of chamber on crimp sleeve. Press sleeve firmly into coaxial shell and crimp.
- C. After assembled coaxial is inserted into connector, push support bushing into grommet until shoulder rests on tubular extension. Then pull sealing sleeve forward until it is snug on grommet.

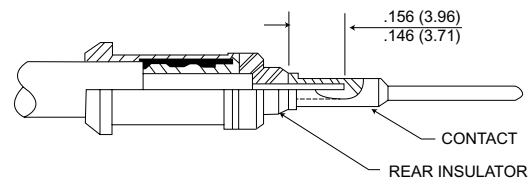

- A. Carefully push inner conductor through rear insulator.
- B. While holding rear insulator firmly against ferrule, trim conductor to .156 (3.96)/.146 (3.91) dimension.
- C. Place contact over conductor and solder.

Polarization Positions

MIL-C-81659B requires that polarizing post be shipped unassembled with the connector. The user then assembles the post in the preferred position and marks the position number on the connector. All DPXNA and DPXNE connectors shall be sold this way. The position number will not be marked.



Face View of Engaging End

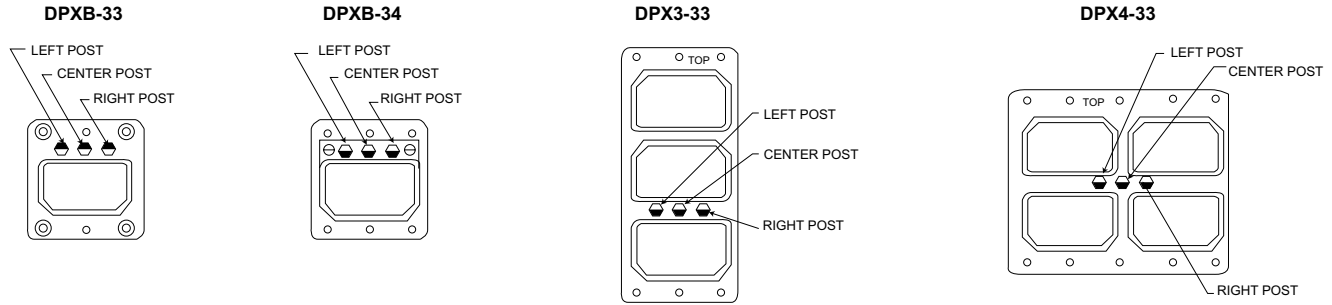

The last two digits in the four-digit dash number refer to the polarizing post position. The polarizing posts will be shipped unassembled with the connector assembly. The position number is not stamped on the connector. This allows the customer to position the posts themselves and then stamp the appropriate number on the shell.

33 PLUG MALE SHELL				34 RECEPTACLE FEMALE SHELL											
Position	Left Post	Center Post	Right Post	Position	Left Post	Center Post	Right Post	Position	Left Post	Center Post	Right Post	Position	Left Post	Center Post	Right Post
01	1	1	1	51	3	2	5	01	4	4	4	51	6	3	2
02	2	1	1	52	4	2	5	02	4	4	3	52	6	3	1
03	3	1	1	53	5	2	5	03	4	4	2	53	6	3	6
04	4	1	1	54	6	2	5	04	4	4	1	54	6	3	5
05	5	1	1	55	1	2	4	05	4	4	6	55	1	3	4
06	6	1	1	56	2	2	4	06	4	4	5	56	1	3	3
07	1	1	6	57	3	2	4	07	5	4	4	57	1	3	2
08	2	1	6	58	4	2	4	08	5	4	3	58	1	3	1
09	3	1	6	59	5	2	4	09	5	4	2	59	1	3	6
10	4	1	6	60	6	2	4	10	5	4	1	60	1	3	5
11	5	1	6	61	1	2	3	11	5	4	6	61	2	3	4
12	6	1	6	62	2	2	3	12	5	4	5	62	2	3	3
13	1	1	5	63	3	2	3	13	6	4	4	63	2	3	2
14	2	1	5	64	4	2	3	14	6	4	3	64	2	3	1
15	3	1	5	65	5	2	3	15	6	4	2	65	2	3	6
16	4	1	5	66	6	2	3	16	6	4	1	66	2	3	5
17	5	1	5	67	1	2	2	17	6	4	6	67	3	3	4
18	6	1	5	68	2	2	2	18	6	4	5	68	3	3	3
19	1	1	4	69	3	2	2	19	1	4	4	69	3	3	2
20	2	1	4	70	4	2	2	20	1	4	3	70	3	3	1
21	3	1	4	71	5	2	2	21	1	4	2	71	3	3	6
22	4	1	4	72	6	2	2	22	1	4	1	72	3	3	5
23	5	1	4	73	1	3	1	23	1	4	6	73	4	2	4
24	6	1	4	74	2	3	1	24	1	4	5	74	4	2	3
25	1	1	3	75	3	3	1	25	2	4	4	75	4	2	2
26	2	1	3	76	4	3	1	26	2	4	3	76	4	2	1
27	3	1	3	77	5	3	1	27	2	4	2	77	4	2	6
28	4	1	3	78	6	3	1	28	2	4	1	78	4	2	5
29	5	1	3	79	1	3	6	29	2	4	6	79	5	2	4
30	6	1	3	80	2	3	6	30	2	4	5	80	5	2	3
31	1	1	2	81	3	3	6	31	3	4	4	81	5	2	2
32	2	1	2	82	4	3	6	32	3	4	3	82	5	2	1
33	3	1	2	83	5	3	6	33	3	4	2	83	5	2	6
34	4	1	2	84	6	3	6	34	3	4	1	84	5	2	5
35	5	1	2	85	1	3	5	35	3	4	6	85	6	2	4
36	6	1	2	86	2	3	5	36	3	4	5	86	6	2	3
37	1	2	1	87	3	3	5	37	4	3	4	87	6	2	2
38	2	2	1	88	4	3	5	38	4	3	3	88	6	2	1
39	3	2	1	89	5	3	5	39	4	3	2	89	6	2	6
40	4	2	1	90	6	3	5	40	4	3	1	90	6	2	5
41	5	2	1	91	3	3	4	41	4	3	6	91	1	2	4
42	6	2	1	92	2	3	4	42	4	3	5	92	1	2	3
43	1	2	6	93	3	3	4	43	5	3	4	93	1	2	2
44	2	2	6	94	4	3	4	44	5	3	3	94	1	2	1
45	3	2	6	95	5	3	4	45	5	3	2	95	1	2	6
46	4	2	6	96	6	3	4	46	5	3	1	96	1	2	5
47	5	2	6	97	1	3	3	47	5	3	6	97	2	2	4
48	6	2	6	98	2	3	3	48	5	3	5	98	2	2	3
49	1	2	5	99	3	3	3	49	6	3	4	99	2	2	2
50	2	2	5					50	6	3	3				

Cross Reference from Military to Cannon Part Numbers

Military Part Number	Cannon Part Number	Military Part Number	Cannon Part Number	Military Part Number	Cannon Part Number
M81659/29A2-0001	DPXBNE-26M-33P-00	M81659/35A2-0122	DPX2NE-32W2MS40W1MS-33B-00	M81659/37A2-0005	DPX3NE-78M-33P-00
0002	DPXBNE-26M-33S-00	0123	DPX2NE-32WMP45MP-33B-00	0006	DPX3NE-78M-33S-00
0009	DPXBNE-40M-33P-00	0124	DPX2NE-32W2MS45MS-33B-00	0013	DPX3NE-120M-33P-00
0010	DPXBNE-40M-33S-00	0125	DPX2NE-32W2MP57MP-33B-00	0014	DPX3NE-120M-33S-00
0017	DPXBNE-45M-33P-00	0126	DPX2NE-32W2MS57MS-33B-00	0021	DPX3NE-135M-33P-00
0018	DPXBNE-45M-33S-00	0127	DPX2NE-32W2MP67MP-33B-00	0022	DPX3NE-135M-33S-00
0025	DPXBNE-57M-33P-00	0128	DPX2NE-32W2MS67MS-33B-00	0029	DPX3NE-171M-33P-00
0026	DPXBNE-57M-33S-00	0129	DPX2NE-32W2MPA106S-33B-00	0030	DPX3NE-171M-33S-00
0033	DPXBNE-67M-33P-00	0130	DPX2NE-32W2MSA106P-33B-00	0037	DPX3NE-201M-33P-00
0034	DPXBNE-67M-33S-00	0131	DPX2NE-40W1MP40W1MP-33B-00	0038	DPX3NE-201M-33S-00
0041	DPXBNE-A106-33P-00	0132	DPX2NE-40W1MS40W1MS-33N-00	0045	DPX3NE-A318-33P-00
0042	DPXBNE-A106-33S-00	0133	DPX2NE-57MPA106S-33B-00	0046	DPX3NE-A318-33S-00
0083	DPXBNE-D8M-33P-00	0134	DPX2NE-57MSA106P-33B-00	0065	DPX3NE-24M-33P-00
0084	DPXBNE-D8M-33S-00	0145	DPX2NE-W8MP57MP-33B-00	0066	DPX3NE-24M-33S-00
0135	DPXBNE-W8M-33P-00	0146	DPX2NE-W8MS57MS-33B-00	0067	DPX3NE-122M-33SP-00
0136	DPXBNE-W8M-33S-00	0147	DPX2NE-57MP26MP-33B-00	0068	DPX3NE-122M-33PS-00
0137	DPXBNE-10W3M-33P-00	0148	DPX2NE-57MS25MS-33B-00	0073	DPX3NE-142M-33P-00
0138	DPXBNE-10W3M-33S-00	0151	DPX2NE-32W4MPA106S-33B-00	0074	DPX3NE-142M-33S-00
0139	DPXBNE-32W2M-33P-00	0152	DPX2NE-32W4MSA106P-33B-00	0075	DPX3NE-240M-33P-00
0140	DPXBNE-32W2M-33S-00	0155	DPX2NE-W8MP32W4MP-33B-00	0076	DPX3NE-240M-33S-00
0141	DPXBNE-40W1M-33P-00	0156	DPX2NE-W8MS32W4MS-33B-00	0079	DPX3NE-A240M-33SP-00
0142	DPXBNE-40W1M-33S-00	0159	DPX2NE-32W4MPW8MP-33B-00	0080	DPX3NE-A240M-33PS-00
0149	DPXBNE-32W4M-33P-00	0160	DPX2NE-32W4MSW8MS-33B-00	0091	DPX3NE-279M-33SP-00
0150	DPXBNE-32W4M-33S-00	M81659/35A2-0003	DPX2NE-26MP26MP-34B-00	0092	DPX3NE-279M-33PS-00
M81659/31A2-001	DPXBNE-26M-33P-00	0004	DPX2NE-26MS26MS-34B-00	0157	DPX3NE-244M-33SP-00
0002	DPXBNE-26M-33S-00	0011	DPX2NE-40MP40MP-34B-00	0158	DPX3NE-244M-33PS-00
0009	DPXBNE-40M-33P-00	0012	DPX2NE-40MS40MS-34B-00	M81659/39A2-0005	DPX3NE-78M-34P-00
0010	DPXBNE-40M-33S-00	0019	DPX2NE-45MP45MP-34B-00	0006	DPX3NE-78M-34S-00
0017	DPXBNE-45M-33P-00	0020	DPX2NE-45MS45MS-34B-00	0013	DPX3NE-120M-34P-00
0018	DPXBNE-45M-33S-00	0027	DPX2NE-57MP57MP-34B-00	0014	DPX3NE-120M-34S-00
0025	DPXBNE-57M-33P-00	0028	DPX2NE-57MS57MS-34B-00	0021	DPX3NE-135M-34P-00
0026	DPXBNE-57M-33S-00	0035	DPX2NE-67MP67MP-34B-00	0022	DPX3NE-135M-34S-00
0033	DPXBNE-67M-33P-00	0036	DPX2NE-67MS67MS-34B-00	0029	DPX3NE-171M-34P-00
0034	DPXBNE-67M-33S-00	0043	DPX2NE-A106PA106P-34B-00	0030	DPX3NE-171M-34S-00
0041	DPXBNE-A106-33P-00	0044	DPX2NE-A106SA106S-34B-00	0037	DPX3NE-201M-34P-00
0042	DPXBNE-A106-33S-00	0057	DPX2NE-A106S26MP-34B-00	0038	DPX3NE-201M-34S-00
0083	DPXBNE-D8M-33P-00	0058	DPX2NE-A106P26MS-34B-00	0045	DPX3NE-A318-34P-00
0084	DPXBNE-D8M-33S-00	0059	DPX2NE-26MPA106S-34B-00	0046	DPX3NE-A318-34S-00
0135	DPXBNE-W8M-33P-00	0060	DPX2NE-26MSA106P-34B-00	0065	DPX3NE-24M-34P-00
0136	DPXBNE-W8M-33S-00	0071	DPX2NE-67MPA106S-34B-00	0066	DPX3NE-24M-34S-00
0137	DPXBNE-10W3M-33P-00	0072	DPX2NE-67MSA106P-34B-00	0067	DPX3NE-122M-34SP-00
0138	DPXBNE-10W3M-33S-00	0087	DPX2NE-A106SW8MP-34B-00	0068	DPX3NE-122M-34PS-00
0139	DPXBNE-32W2M-33P-00	0088	DPX2NE-A106PW8MS-34B-00	0073	DPX3NE-142M-34P-00
0140	DPXBNE-32W2M-33S-00	0089	DPX2NE-A106S67MP-34B-00	0074	DPX3NE-142M-34S-00
0141	DPXBNE-40W1M-33P-00	0090	DPX2NE-A106P67MS-34B-00	0075	DPX3NE-240M-34P-00
0142	DPXBNE-40W1M-33S-00	0109	DPX2NE-C2P40W1MP-34B-00	0076	DPX3NE-240M-34S-00
0149	DPXBNE-32W4M-33P-00	0110	DPX2NE-C2S40W1MS-34B-00	0079	DPX3NE-A240M-34SP-00
0150	DPXBNE-32W4M-33S-00	0111	DPX2NE-C2P57MP-34B-00	0080	DPX3NE-A240M-34PS-00
M81659/33A2-0003	DPX2NE-26MP26MP-33B-00	0112	DPX2NE-C2S57MS-34B-00	0091	DPX3NE-279M-34SP-00
0004	DPX2NE-26MS26MS-33B-00	0113	DPX2NE-AC3P67MP-34B-00	0092	DPX3NE-279M-34PS-00
0011	DPX2NE-40MP40MP-33B-00	0114	DPX2NE-AC3S67MS-34B-00	0157	DPX3NE-244M-34SP-00
0012	DPX2NE-40MS40MS-33B-00	0115	DPX2NE-AC3PA106S-34B-00	0158	DPX3NE-244M-34PS-00
0019	DPX2NE-45MP45MP-33B-00	0116	DPX2NE-AC3SA106P-34B-00	M81659/41A2-0007	DPX4NE-104M-33P-00
0020	DPX2NE-45MS45MS-33B-00	0117	DPX2NE-W8MPA106S-34B-00	0008	DPX4NE-104M-33S-00
0027	DPX2NE-57MP57MP-33B-00	0118	DPX2NE-W8MSA106P-34B-00	0015	DPX4NE-160M-33P-00
0028	DPX2NE-57MS57MS-33B-00	0119	DPX2NE-10W3P32W2MP-34B-00	0016	DPX4NE-160M-33S-00
0035	DPX2NE-67MP67MP-33B-00	0120	DPX2NE-10W3S32W2MS-34B-00	0023	DPX4NE-180M-33P-00
0036	DPX2NE-67MS67MS-33B-00	0121	DPX2NE-32W2MP40W1MP-34B-00	0024	DPX4NE-180M-33S-00
0043	DPX2NE-A106PA106P-33B-00	0122	DPX2NE-32W2MS40W1MS-34B-00	0031	DPX4NE-228M-33P-00
0044	DPX2NE-A106SA106S-33B-00	0123	DPX2NE-32W2MP45MP-34B-00	0032	DPX4NE-228M-33S-00
0057	DPX2NE-A106S26MP-33B-00	0124	DPX2NE-32W3MS45MS-34B-00	0039	DPX4NE-268M-33P-00
0058	DPX2NE-A106P26MS-33B-00	0125	DPX2NE-32W2MP57MP-34B-00	0040	DPX4NE-268M-33S-00
0059	DPX2NE-26MPA106S-33B-00	0126	DPX2NE-32W3MS57MS-34B-00	0047	DPX4NE-A424-33P-00
0060	DPX2NE-26MSA106P-33B-00	0127	DPX2NE-32W2MP67MP-34B-00	0048	DPX4NE-A424-33S-00
0071	DPX2NE-67MPA106S-33B-00	0128	DPX2NE-32W2MS67MS-34B-00	0061	DPX4NE-104M-33P-00
0072	DPX2NE-67MSA106P-33B-00	0129	DPX2NE-32W2MPA106S-34B-00	0062	DPX4NE-104M-33S-00
0087	DPX2NE-A106PW8MP-33B-00	0130	DPX2NE-32W2MSA106P-34B-00	0063	DPX4NE-95M-33P-00
0088	DPX2NE-A106PW8MS-33B-00	0131	DPX2NE-40W1MP40W1MP-34B-00	0064	DPX4NE-95M-33S-00
0089	DPX2NE-A106S67MP-33B-00	0132	DPX2NE-40W1MS40W1MS-34B-00	0085	DPX4NE-150M-33P-00
0090	DPX2NE-A106P67MS-33B-00	0133	DPX2NE-57MPA106S-34B-00	0086	DPX4NE-150M-33S-00
0109	DPX2NE-C2P40W1MP-33B-00	0134	DPX2NE-57MSA106P-34B-00	0095	DPX4NE-326M-33SP-00
0110	DPX2NE-C2S40W1MS-33B-00	0145	DPX2NE-W8MP57MP-34B-00	0096	DPX4NE-326M-33PS-00
0111	DPX2NE-C2P57MP-33B-00	0146	DPX2NE-W8MS57MS-34B-00	0097	DPX4NE-287M-33SP-00
0112	DPX2NE-C2S57MS-33B-00	0147	DPX2NE-57MP26MP-34B-00	0098	DPX4NE-287M-33PS-00
0113	DPX2NE-AC3P67MP-33B-00	0148	DPX2NE-57MS26MS-34B-00	0099	DPX4NE-189M-33SP-00
0114	DPX2NE-AC3S67MS-33B-00	0151	DPX2NE-32W4MPA106S-34B-00	0100	DPX4NE-189M-33PS-00
0115	DPX2NE-AC3PA106S-33B-00	0152	DPX2NE-32W4MSA106P-34B-00	0101	DPX4NE-346M-33SP-00
0116	DPX2NE-AC3SA106P-33B-00	0155	DPX2NE-W8MP32W4MP-34B-00	0102	DPX4NE-346M-33PS-00
0117	DPX2NE-W8MSA106S-33B-00	0156	DPX2NE-W8MS32W4MS-34B-00		
0118	DPX2NE-W8MSA106P-33B-00	0159	DPX2NE-32W4MPW8MP-34B-00		
0119	DPX2NE-10W3MP32W2MP-33B-00	0160	DPX2NE-32W4MSW8MS-34B-00		
0120	DPX2NE-10W3MS32W2MS-33B-00				
0121	DPX2NE-32W2MP40W1MP-33B-00				

Cross Reference from Military to Cannon Part Numbers (Continued)

Military Part Number	Cannon Part Number	Military Part Number	Cannon Part Number	Military Part Number	Cannon Part Number
M81659/43A2-0007	DPX4NE-104M-34P-00	M81659/62A2-0121	DPX2NE-32W2MP40W1MP-34S-29	M81659i65A2-0026	DPXBNA-57M-33S-00
0008	DPX4NE-104M-34S-00	0122	DPX2NE-32W2MP40W1MS-34B-29	0033	DPXBNA-67M-33P-00
0015	DPX4NE-160M-34P-00	0123	DPX2NE-32W2MP45MP-34B-29	0034	DPXBNA-67M-33S-00
0016	DPX4NE-160M-34S-00	0124	DPX2NE-32W2MS45MS-34B-29	0041	DPXBNA-A106-33P-00
0023	DPX4NE-180M-34P-00	0125	DPX2NE-32W2MP57MP-34B-29	0042	DPXBNA-A106-33S-00
0024	DPX4NE-180M-34S-00	0126	DPX2NE-32W2MS57MS-34B-29	0083	DPXBNA-D8M-33P-00
0031	DPX4NE-228M-34P-00	0127	DPX2NE-32W2MP67MP-34B-29	0084	DPXBNA-D8M-33S-00
0032	DPX4NE-228M-34S-00	0128	DPX2NE-32W2MS67MS-34B-29	0135	DPXBNA-W8M-33P-00
0039	DPX4NE-268M-34P-00	0129	DPX2NE-32W2MPA106S-34B-29	0136	DPXBNA-W8M-33S-00
0040	DPX4NE-268M-34S-00	0130	DPX2NE-32W2MSA106P-34B-29	0137	DPXBNA-10W3M-33P-00
0047	DPX4NE-A424-34P-00	0131	DPX2NE-40W1MP40W1MP-34B-29	0138	DPXBNA-10W3M-33S-00
0048	DPX4NE-A424-34S-00	0132	DPX2NE-40WIMS40W1MS-34B-29	0139	DPXBNA-32W2M-33P-00
0061	DPX4NE-104M-34P-00	0133	DPX2NE-57MPA106S-34B-29	0140	DPXBNA-32W2M-33S-00
0062	DPX4NE-104M-34S-00	0134	DPX2NE-57MSA106P-34B-29	0141	DPXBNA-40W1M-33P-00
0063	DPX4NE-95M-34P-00	0145	DPX2NE-W8MP57MP-34B-29	0142	DPXBNA-40W1M-33S-00
0064	DPX4NE-95M-34S-00	0146	DPX2NE-W8MS57MS-34B-29	0149	DPXBNA-32W4M-33P-00
0085	DPX4NE-150M-34P-00	0147	DPX2NE-57MP26MP-34B-29	0150	DPXBNA-32W4M-33S-00
0086	DPX4NE-150M-34S-00	0148	DPX2NE-57MS26MS-34B-29	M81659/66A2-0001	DPXBNA-26M-34P-00
0095	DPX4NE-326M-34S-00	0151	DPX2NE-32W4MPA106S-34B-29	0002	DPXBNA-26M-34S-00
0096	DPX4NE-326M-34PS-00	0152	DPX2NE-32W4MSA106P-34B-29	0009	DPXBNA-40M-34P-00
0097	DPX4NE-287M-34S-00	0155	DPX2NE-W8MP32W4MP-34B-29	0010	DPXBNA-40M-34S-00
0098	DPX4NE-287M-34PS-00	0156	DPX2NE-W8MS32W4MS-34B-29	0017	DPXBNA-45M-34P-00
0099	DPX4NE-189M-34S-00	0159	DPX2NE-32W4MPW8MP-34B-29	0018	DPXBNA-45M-34S-00
0100	DPX4NE-189M-34PS-00	0160	DPX2NE-32W4MSW8MS-34B-29	0025	DPXBNA-57M-34P-00
0101	DPX4NE-346M-34S-00	M81659/63A2-0005	DPX3NE-78M-34P-29	0026	DPXBNA-57M-34S-00
0102	DPX4NE-346M-34PS-00	0006	DPX3NE-78M-34S-29	0033	DPXBNA-67M-34P-00
M81659/61A2-0001	DPXBNE-26M-34P-29	0013	DPX3NE-120M-34P-29	0034	DPXBNA-67M-34S-00
0002	DPXBNE-26M-34S-29	0014	DPX3NE-120M-34S-29	0041	DPXBNA-A106-34P-00
0009	DPXBNE-40M-34P-29	0021	DPX3NE-135M-34P-29	0042	DPXBNA-A106-34S-00
0010	DPXBNE-40M-34S-29	0022	DPX3NE-135M-34S-29	0083	DPXBNA-D8M-34P-00
0017	DPXBNE-45M-34P-29	0029	DPX3NE-171M-34P-29	0084	DPXBNA-D8M-34S-00
0018	DPXBNE-45M-34S-29	0030	DPX3NE-171M-34S-29	0135	DPXBNA-W8M-34P-00
0025	DPXBNE-57M-34P-29	0037	DPX3NE-201M-34P-29	0136	DPXBNA-W8M-34S-00
0026	DPXBNE-57M-34S-29	0038	DPX3NE-201M-34S-29	0137	DPXBNA-10W3M-34P-00
0033	DPXBNE-67M-34P-29	0041	DPX3NE-A318-30-29	0138	DPXBNA-10W3M-34S-00
0034	DPXBNE-67M-34S-29	0046	DPX3NE-A318-34S-29	0139	DPXBNA-32W2M-34P-00
0041	DPXBNE-A106-34P-29	0065	DPX3NE-24M-34P-29	0140	DPXBNA-32W2M-34S-00
0042	DPXBNE-A106-34S-29	0066	DPX3NE-24M-34S-29	0141	DPXBNA-40W1M-34P-00
0083	DPXBNE-D8M-34P-29	0067	DPX3NE-122M-34SP-29	0142	DPXBNA-40W1M-34S-00
0084	DPXBNE-D8M-34S-29	0068	DPX3NE-122M-34PS-29	0149	DPXBNA-32W4M-34P-00
0135	DPXBNE-W8M-34P-29	0073	DPX3NE-142M-34P-29	0150	DPXBNA-32W4M-34S-00
0136	DPXBNE-W8M-34S-29	0074	DPX3NE-142M-34S-29	M81659 67A2-0001	DPXBNA-26M-34P-01
0137	DPXBNE-10W3M-34P-29	0075	DPX3NE-240M-34P-29	0002	DPXBNA-26M-34S-01
0138	DPXBNE-10W3M-34S-29	0076	DPX3NE-240M-34S-29	0009	DPXBNA-40M-34P-01
0139	DPXBNE-32W2M-34P-29	0079	DPX3NE-A240M-34SP-29	0010	DPXBNA-40M-34S-01
0140	DPXBNE-32W2M-34S-29	0080	DPX3NE-A240M-34PS-29	0017	DPXBNA-45M-34P-01
0141	DPXBNE-40W1M-34P-29	0091	DPX3NE-279M-34SP-29	0018	DPXBNA-45M-34S-01
0142	DPXBNE-40W1M-34S-29	0092	DPX3NE-279M-34PS-29	0025	DPXBNA-57M-34P-01
0149	DPXBNE-32W4M-34P-29	0157	DPX3NE-244M-34SP-29	0026	DPXBNA-57M-34S-01
0150	DPXBNE-32W4M-34S-29	0158	DPX3NE-244M-34PS-29	0033	DPXBNA-67M-34P-01
M81659/62A2-0003	DPX2NE-26MP-26MP-34B-29	M81659/ 64A2-0007	DPX4NE-104M-34P-29	0034	DPXBNA-67M-34S-01
0004	DPX2NE-26MS26MS-34B-29	0008	DPX4NE-104M-34S-29	0041	DPXBNA-A106-34P-01
0011	DPX2NE-40MP40MP-34B-29	0015	DPX4NE-160M-34P-29	0042	DPXBNA-A106-34S-01
0012	DPX2NE-40MS40MS-34B-29	0016	DPX4NE-160M-34S-29	0083	DPXBNA-D8M-34P-01
0019	DPX2NE-45MP45MP-34B-29	0023	DPX4NE-180M-34P-29	0084	DPXBNA-D8M-34S-01
0020	DPX2NE-45MS45MS-34B-29	0024	DPX4NE-180M-34S-29	0135	DPXBNA-W8M-34P-01
0027	DPX2NE-57MP57MP-34B-29	0031	DPX4NE-228M-34P-29	0136	DPXBNA-W8M-34S-01
0028	DPX2NE-57MS57MS-34B-29	0032	DPX4NE-228M-34S-29	0137	DPXBNA-10W3M-34P-01
0035	DPX2NE-67MP67MP-34B-29	0039	DPX4NE-268M-34P-29	0138	DPXBNA-10W3M-34S-01
0036	DPX2NE-67MS67MS-34B-29	0040	DPX4NE-268M-34S-29	0139	DPXBNA-32W2M-34P-01
0043	DPX2NE-A106PA106P-34B-29	0047	DPX4NE-A424-34P-29	0140	DPXBNA-32W2M-34S-01
0044	DPX2NE-A106SA106S-34B-29	0048	DPX4NE-A424-34S-29	0141	DPXBNA-40W1M-34P-01
0057	DPX2NE-A106S26MP-34B-29	0061	DPX4NE-104M-34P-29	0142	DPXBNA-40W1M-34S-01
0058	DPX2NE-A106P26MS-34B-29	0062	DPX4NE-104M-34S-29	0149	DPXBNA-32W4M-34P-01
0059	DPX2NE-26MPA106S-34B-29	0063	DPX4NE-95M-34P-29	0150	DPXBNA-32W4M-34S-01
0060	DPX2NE-26MSA106P-34B-29	0064	DPX4NE-95M-34S-29	M81659/68A2-0001	DPXBNA-26M-34P-23
0071	DPX2NE-67MPA106S-34B-29	0085	DPX4NE-150M-34P-29	0002	DPXBNA-26M-34S-23
0072	DPX2NE-67MSA106P-34B-29	0086	DPX4NE-150M-34S-29	0009	DPXBNA-40M-34P-23
0087	DPX2NE-A10BSW8MP-34B-29	0095	DPX4NE-326M-34SP-29	0010	DPXBNA-40M-34S-23
0088	DPX2NE-A10BPW8MS-34B-29	0096	DPX4NE-326M-34PS-29	0017	DPXBNA-45M-34P-23
0089	DPX2NE-A106S67MP-34B-29	0097	DPX4NE-287M-34SP-29	0018	DPXBNA-45M-34S-23
0090	DPX2NE-A106P67MS-34B-29	0098	DPX4NE-287M-34PS-29	0025	DPXBNA-57M-34P-23
0109	DPX2NE-C2P46W1MP-34B-29	0099	DPX4NE-189M-34SP-29	0026	DPXBNA-57M-34S-23
0110	DPX2NE-C2S40W1MS-34B-29	0100	DPX4NE-189M-34PS-29	0033	DPXBNA-67M-34P-23
0111	DPX2NE-C2P57MP-34B-29	0101	DPX4NE-346M-34SP-29	0034	DPXBNA-67M-34S-23
0112	DPX2NE-C2S57MS-34B-29	0102	DPX4NE-346M-34PS-29	0041	DPXBNA-A106-34P-23
0113	DPX2NE-AC3P67MP-34B-29	M81659/65A2-0001	DPXBNA-26M-33P-00	0042	DPXBNA-A106-34S-23
0114	DPX2NE-AC3S67MS-34B-29	0002	DPXBNA-26M-33S-00	0083	DPXBNA-D8M-34P-23
0115	DPX2NE-AC3PA106S-34B-29	0009	DPXBNA-40M-33P-00	0084	DPXBNA-D8M-34S-23
0116	DPX2NE-AC3SA106P-34B-29	0010	DPXBNA-40M-33S-00	0135	DPXBNA-W8M-34P-23
0117	DPX2NE-W8MPA106S-34B-29	0017	DPXBNA-45M-33P-00	0136	DPXBNA-W8M-34S-23
0118	DPX2NE-W8MSA106P-34B-29	0018	DPXBNA-45M-33S-00	0137	DPXBNA-10W3M-34P-23
0119	DPX2NE-10W3P32W2MP-34B-29	0025	DPXBNA-57M-33P-00		
0120	DPX2NE-10W3S32W2MS-34B-29				

Cross Reference from Military to Cannon Part Numbers

Military Part Number	Cannon Part Number	Military Part Number	Cannon Part Number	Military Part Number	Cannon Part Number
M81659/68A2-0138	DPXBNA-10W3M-34S-23	M81659/70A2-0060	DPX2NA-26MSA106P-34B-00	M81659/71A2-0126	DPX2NA-32W2MS57MS-34B-01
0139	DPXBNA-32W2M-34P-23	0071	DPX2NA-67MPA106S-34B-00	0127	DPX2NA-32W2MP67MP-34B-01
0140	DPXBNA-32W2M-34S-23	0072	DPX2NA-67MSA106P-34B-00	0128	DPX2NA-32W2MS67MS-34B-01
0141	DPXBNA-40W1M-34P-23	0087	DPX2NA-A106SW8MP-34B-00	0129	DPX2NA-32W2MPA106S-34B-01
0142	DPXBNA-40W1M-34S-23	0088	DPX2NA-A106PW8MS-34B-00	0130	DPX2NA-32W2MSA106P-34B-01
0149	DPXBNA-32W4M-34P-23	0089	DPX2NA-A106S67MP-34B-00	0131	DPX2NA-40W1MP40W1MP-34B-01
0150	DPXBNA-32W4M-34S-23	0090	DPX2NA-A106P67MS-34B-00	0132	DPX2NA-40W1MS40W1MS-34B-01
M81659/69A2-0003	DPX2NA-26MP26MP-33B-00	0109	DPX2NA-C2P40W1MP-34B-00	0133	DPX2NA-57MPA106S-34B-01
0004	DPX2NA-26MS26MS-33B-00	0110	DPX2NA-C2S40W1MS-34B-00	0134	DPX2NA-57MSA106P-34B-01
0011	DPX2NA-40MP40MP-33B-00	0111	DPX2NA-C2P57MP-34B-00	0145	DPX2NA-W8MP57MP-34B-01
0012	DPX2NA-40MS40MS-33B-00	0112	DPX2NA-C2S57MS-34B-00	0146	DPX2NA-W8MS57MS-34B-01
0019	DPX2NA-45MP45MP-33B-00	0113	DPX2NA-AC3P67MP-34B-00	0147	DPX2NA-57MP26MP-34B-01
0020	DPX2NA-45MS45MS-33B-00	0114	DPX2NA-AC3S67MS-34B-00	0148	DPX2NA-57MS26MS-34B-01
0027	DPX2NA-57MP57MP-33B-00	0115	DPX2NA-AC3PA106S-34B-00	0151	DPX2NA-32W4MPA106S-34B-01
0028	DPX2NA-57MS57MS-33B-00	0116	DPX2NA-AC3SA106P-34B-00	0152	DPX2NA-32W4MSA106P-34B-01
0035	DPX2NA-67MP67MP-33B-00	0117	DPX2NA-W8MPA106S-34B-00	0155	DPX2NA-W8MP32W4MP-34B-01
0036	DPX2NA-67MS67MS-33B-00	0118	DPX2NA-W8MSA106P-34B-00	0156	DPX2NA-W8MS32W4MS-34B-01
0043	DPX2NA-A106PA106P-33B-00	0119	DPX2NA-10W3P32W2MP-34B-00	0159	DPX2NA-32W4MPW8MP-34B-01
0044	DPX2NA-A106SA106S-33B-00	0120	DPX2NA-10W3S32W2MS-34B-00	0160	DPX2NA-32W4MSW8MS-34B-01
0057	DPX2NA-A106S26MP-33B-00	0121	DPX2NA-32W2MP40W1MP-34B-00	M81659/72A2-0003	DPX2NA-26MP26MP-34B-23
0058	DPX2NA-A106P26MS-33B-00	0122	DPX2NA-32W2MS40W1MS-34B-00	0004	DPX2NA-26MS26MS-34B-23
0059	DPX2NA-26MPA106S-33B-00	0123	DPX2NA-32W2MP45MP-34B-00	0011	DPX2NA-40MP40MP-34B-23
0060	DPX2NA-26MSA106P-33B-00	0124	DPX2NA-32W2MS45MS-34B-00	0012	DPX2NA-40MS40MS-34B-23
0071	DPX2NA-67MPA106S-33B-00	0125	DPX2NA-32W2MP57MP-34B-00	0019	DPX2NA-45MP45MP-34B-23
0072	DPX2NA-67MSA106P-33B-00	0126	DPX2NA-32W2MS57MS-34B-00	0020	DPX2NA-45MS45MS-34B-23
0087	DPX2NA-A106SW8MP-33B-00	0127	DPX2NA-32W2MP67MP-34B-00	0027	DPX2NA-57MP57MP-34B-23
0088	DPX2NA-A106PW8MS-33B-00	0128	DPX2NA-32W2MS67MS-34B-00	0028	DPX2NA-57MS57MS-34B-23
0089	DPX2NA-A106S67MP-33B-00	0129	DPX2NA-32W2MPA106S-34B-00	0035	DPX2NA-67MP67MP-34B-00
0090	DPX2NA-A106P67MS-33B-00	0130	DPX2NA-32W2MSA106P-34B-00	0036	DPX2NA-67MS67MS-34B-23
0109	DPX2NA-C2P40W1MP-33B-00	0131	DPX2NA-40W1MP40W1MP-34B-00	0043	DPX2NA-A106PA106P-34B-23
0110	DPX2NA-C2S40W1MS-33B-00	0132	DPX2NA-40W1MS40W1MS-34B-00	0044	DPX2NA-A106SA106S-34B-23
0111	DPX2NA-C2P57MP-33B-00	0133	DPX2NA-57MPA106S-34B-00	0057	DPX2NA-A106S26MP-34B-23
0112	DPX2NA-C2S57MS-33B-00	0134	DPX2NA-57MSA106P-34B-00	0058	DPX2NA-A106P26MS-34B-23
0113	DPX2NA-AC3P67MP-33B-00	0145	DPX2NA-W8MP57MP-34B-00	0059	DPX2NA-26MPA106S-34B-23
0114	DPX2NA-AC3S67MS-33B-00	0146	DPX2NA-W8MS57MS-34B-00	0060	DPX2NA-26MSA106P-34B-23
0115	DPX2NA-AC3PA106S-33B-00	0147	DPX2NA-57MP26MP-34B-00	0071	DPX2NA-67MPA106S-34B-23
0116	DPX2NA-AC3SA106P-33B-00	0148	DPX2NA-57MS26MS-34B-00	0072	DPX2NA-67MSA106P-34B-23
0117	DPX2NA-W8MPA106S-33B-00	0151	DPX2NA-32W4MPA106S-34B-00	0087	DPX2NA-A106SW8MP-34B-23
0118	DPX2NA-W8MSA106P-33B-00	0152	DPX2NA-32W4MSA106P-34B-00	0088	DPX2NA-A106PW8MS-34B-23
0119	DPX2NA-10W3P32W2MP-33B-00	0155	DPX2NA-W8MP32W4MP-34B-00	0089	DPX2NA-A106S67MP-34B-23
0120	DPX2NA-10W3S32W2MS-33B-00	0156	DPX2NA-W8MP32W4MS-34B-00	0090	DPX2NA-A106P67MS-34B-23
0121	DPX2NA-32W2MP40W1MP-33B-00	0159	DPX2NA-32W4MPW8MP-34B-00	0109	DPX2NA-C2P40W1MP-34B-23
0122	DPX2NA-32W2MS40W1MS-33B-00	0160	DPX2NA-32W4MSW8MS-34B-00	0110	DPX2NA-C2S40W1MS-34B-23
0123	DPX2NA-32W2MP45MP-33B-00	M81659/71A2-0003	DPX2NA-26MP26MP-34B-01	0111	DPX2NA-C2P57MP-34B-23
0124	DPX2NA-32W2MS45MS-33B-00	0004	DPX2NA-26MS26MS-34B-01	0112	DPX2NA-C2S57MS-34B-23
0125	DPX2NA-32W2MP57MP-33B-00	0011	DPX2NA-40MP40MP-34B-01	0113	DPX2NA-AC3P67MP-34B-23
0126	DPX2NA-32W2MS57MS-33B-00	0012	DPX2NA-40MS40MS-34B-01	0114	DPX2NA-AC3P67MS-34B-23
0127	DPX2NA-32W2MP67MP-33B-00	0019	DPX2NA-45MP45MP-34B-01	0115	DPX2NA-AC3PA106S-34B-23
0128	DPX2NA-32W2MS67MS-33B-00	0020	DPX2NA-45MS45MS-34B-01	0116	DPX2NA-AC3SA106P-34B-23
0129	DPX2NA-32W2MPA106S-33B-00	0027	DPX2NA-57MP57MP-34B-01	0117	DPX2NA-W8MPA106S-34B-23
0130	DPX2NA-32W2MSA106P-33B-00	0028	DPX2NA-57MS57MS-34B-01	0118	DPX2NA-W8MSA106P-34B-23
0131	DPX2NA-40W1MP40W1MP-33B-00	0035	DPX2NA-67MP67MP-34B-01	0119	DPX2NA-10W3P32W2MP-34B-23
0132	DPX2NA-40W1MS40W1MS-33B-00	0036	DPX2NA-67MS67MS-34B-01	0120	DPX2NA-10W3S32W2MS-34B-23
0133	DPX2NA-57MPA106S-33B-00	0043	DPX2NA-A106PA106P-34B-01	0121	DPX2NA-32W2MP40W1MP-34B-23
0134	DPX2NA-57MSA106P-33B-00	0044	DPX2NA-A106SA106S-34B-01	0122	DPX2NA-32W2MS40W1MS-34B-23
0145	DPX2NA-W8MP57MP-33B-00	0057	DPX2NA-A106S26MP-34B-01	0123	DPX2NA-32W2MP45MP-34B-23
0146	DPX2NA-W8MS57MS-33B-00	0058	DPX2NA-A106P26MS-34B-01	0124	DPX2NA-32W2MS45MS-34B-23
0147	DPX2NA-57MP26MP-33B-00	0059	DPX2NA-26MPA106S-34B-01	0125	DPX2NA-32W2MP57MP-34B-23
0148	DPX2NA-57MS26MS-33B-00	0060	DPX2NA-26MSA106P-34B-01	0126	DPX2NA-32W2MS57MS-34B-23
0151	DPX2NA-32W4MPA106S-33B-00	0071	DPX2NA-67MPA106S-34B-01	0127	DPX2NA-32W2MP67MP-34B-23
0152	DPX2NA-32W4MSA106P-33B-00	0072	DPX2NA-67MSA106P-34B-01	0128	DPX2NA-32W2MS67MS-34B-23
0155	DPX2NA-W8MP32W4MP-33B-00	0087	DPX2NA-A106SW8MP-34B-01	0129	DPX2NA-32W2MPA106S-34B-23
0156	DPX2NA-W8MS32W4MS-33B-00	0088	DPX2NA-A106PW8MS-34B-01	0130	DPX2NA-32W2MSA106P-34B-23
0159	DPX2NA-32W4MPW8MP-33B-00	0089	DPX2NA-A106S67MP-34B-01	0131	DPX2NA-40W1MP40W1MP-34B-23
0160	DPX2NA-32W4MSW8MS-33B-00	0090	DPX2NA-A106P67MS-34B-01	0132	DPX2NA-40W1MS40W1MS-34B-23
M81659/70A2-0003	DPX2NA-26MP26MP-34B-00	0109	DPX2NA-C2P40W1MP-34B-01	0133	DPX2NA-57MPA106S-34B-23
0004	DPX2NA-26MS26MS-34B-00	0110	DPX2NA-C2S40W1MS-34B-01	0134	DPX2NA-57MSA106P-34B-23
0011	DPX2NA-40MP40MP-34B-00	0111	DPX2NA-C2P57MP-34B-01	0145	DPX2NA-W8MP57MP-34B-23
0012	DPX2NA-40MS40MS-34B-00	0112	DPX2NA-C2S57MS-34B-01	0146	DPX2NA-W8MS57MS-34B-23
0019	DPX2NA-45MP45MP-34B-00	0113	DPX2NA-AC3P67MP-34B-01	0147	DPX2NA-57MP26MP-34B-23
0020	DPX2NA-45MS45MS-34B-00	0114	DPX2NA-AC3S67MS-34B-01	0148	DPX2NA-57MS26MS-34B-23
0027	DPX2NA-57MP57MP-34B-00	0115	DPX2NA-AC3PA106S-34B-01	0151	DPX2NA-32W4MPA106S-34B-23
0028	DPX2NA-57MS57MS-34B-00	0116	DPX2NA-AC3SA106P-34B-01	0152	DPX2NA-32W4MSA106P-34B-23
0035	DPX2NA-67MP67MP-34B-00	0117	DPX2NA-W8MPA106S-34B-01	0155	DPX2NA-W8MP32W4MP-34B-23
0036	DPX2NA-67MS67MS-34B-00	0118	DPX2NA-W8MSA106P-34B-01	0156	DPX2NA-W8MS32W4MS-34B-23
0043	DPX2NA-A106PA106P-34B-00	0119	DPX2NA-10W3P32W2MP-34B-01	0159	DPX2NA-32W4MPW8MP-34B-23
0044	DPX2NA-A106SA106S-34B-00	0120	DPX2NA-10W3S32W2MS-34B-01	0160	DPX2NA-32W4MSW8MS-34B-23
0057	DPX2NA-A106S26MP-34B-00	0121	DPX2NA-32W2MP40W1MP-34B-01		
0058	DPX2NA-A106P26MS-34B-00	0122	DPX2NA-32W2MS40W1MS-34B-01		
0059	DPX2NA-26MPA106P-34B-00	0123	DPX2NA-32W2MP45MP-34B-01		
		0124	DPX2NA-32W2MS45MS-34B-01		
		0125	DPX2NA-32W2MP57MP-34B-01		

Coaxial Cable Reference Guide

For BKA*, DPX Series (Crimp, & Solder)

Reference MIL-C-17D & DPX NE/NA MIL-C-81659 Series

RG/U Type	Inner Conductor	Dielectric Material	DOD (Inch)	Jacket Material	O.D (Inch)	Weight (lbs/ft)	Max. Oper. Temp. Range (C)	Max. Oper. Voltage (Volts RMS)	Suggested Alt Cable	Code Crimp Type Coax	Code Solder Type Coax	DPX NE/NA Military
7	0.0359"	Air-space PE	0.250	PVC	0.370	0.080	- 40 + 80	1,000	Use RG63B	-	I	-
9	0.0855"	PE	0.280	PVC	0.420	0.140	- 40 + 80	4,000	Use RG214	-	R,AC	-
55	0.0320"	PE	0.116	PE	0.206 MAX	0.032	- 55 + 80	1,900	Use RG55B	S	C,J	-
58	0.0320" BC	PE	0.116	PVC	0.195	0.029	- 40 + 80	1,900	Use RG58B	D,P,G J,AC,AD	C,J,Z, AB	Size 5/9 Seal 1
59	0.0253"	PE	0.146	PVC	0.242	0.032	- 40 + 80	2,300	Use RG59B	A,F,T	D	-
59B	0.0230'	PE	0.146	PVC	0.242	0.032	- 40 + 80	2,300	Use up to 1000 MHz	-	-	-
62	0.0253"	Air-space PE	0.146	PVC	0.242	0.038	- 40 + 80	750	Use RG62A	A,F,T	E	-
62A	0.0253"	Air-space PE	0.146	PVC	0.242	0.038	- 40 + 80	750	-	-	-	-
71	0.0253"	Air-space PE	0.146	PVC	0.250 Max.	0.046	- 40 + 80	750	Use RG71B	-	E	-
115	0.0840"	PTFE	0.250	FG Braid	0.375	0.148	- 55 + 250	5,000	Use RG115A	V	-	-
142	0.0359"	PTFE	0.116	FG Braid	0.206 Max	0.047	- 55 + 250	1,900	Use RG142A	S,AE	-	Size 5/9 Seal 1
142B	0.0390"	PTFE	0.116	FEP	0.195	0.050	- 55 + 200	1,900	-	-	-	-
174	0.0189"	PE	0.060	PVC	0.100	0.008	- 40 + 80	1,500	-	D,H,U AF	-	Size 5/9 Seal 2
178	0.0120"	PTFE	0.036	KEL-F	0.079 Max	0.0054	- 40 + 150	1,000	Use RG178B	E,R,K,AG, L,M,AF	-	Size 5/9 Seal 1
179	0.0120"	PTFE	0.057	KEL-F	0.094 Max	0.010	- 55 + 150	1,200	Use RG179B	D,H,U AF	-	Size 5/9 Seal 1 Seal 2
179B	0.0120"	PTFE	0.063	FEP	0.100	0.010	- 55 + 200	1,200	-	-	-	-
180	0.0120"	PTFE	0.103	KEL-F	0.141 Max.	0.019	- 40 + 150	1,500	Use RG180B	C,AB	B	Size 5/9 Seal 1
180B	0.0120"	PTFE	0.102	FEP	0.145 Max	0.019	- 55 + 200	1,500	-	AB	-	-
187	0.0120"	PTFE	0.060	PTFE	0.110 Max.	0.010	- 55 + 250	1,200	Use RG179B	D,H,U AF	A,K	-
188	0.0201"	PTFE	0.060	PTFE	0.110 Max.	0.011	- 55 + 250	1,200	Use RG316	D,H,U, AF	A,K	-
195		PTFE	0.102	PTFE	0.155 Max.	0.020	- 55 + 250	1,500	Use RG180B	C,AB	B	-
196		PTFE	0.034	PTFE	0.080 Max.	0.006	- 55 + 250	1,000	Use RG178B	E,R,K, L,AA,AG	AA	Size 5/9 Seal 1
214	0.0888"	PE	0.285	PVC	0.425	0.126	- 40 + 80	5,000	-	-	R,AC	-
223	0.035"	pE	0.116	PVC	0.216 Max.	0.034	- 40 + 80	1,900	-	-	C,J	-
225	0.0936'	PTFE	0.285	FG Braid	0.430	0.180	- 55 + 250	5,000	-	-	-	Size 5/9 Seal 2
316	0.0201"	PTFE	0.060	FEP	0.102	0.012	- 55 + 200	1,200	Use RG188A	-	-	Size 5/9 Seal 2
393	0.0936"	PTFE	0.285	FEP	0.390	0.165	- 55 + 200	5,000	Use RG225	-	-	-
400	0.0385"	PTFE	0.116	FEP	0.195	0.050	- 55 + 200	1,900	-	-	-	-
402	0.0360'	PTFE	0.119	None	0.141	0.032	- 55 + 200	2,500	Use RG142B	-	-	-

Junction Shells

90° Angle

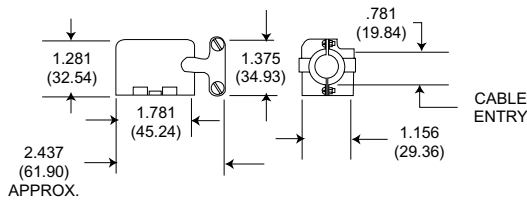

Style	Part Number
(Right) DPXA	20745-22
(Left) DPXA	20745-23
(Right) DPX2	20745-10
(Left) DPX2	20745-11

**(DPXA ONLY)
DIECAST STRAIGHT JUNCTION SHELL**

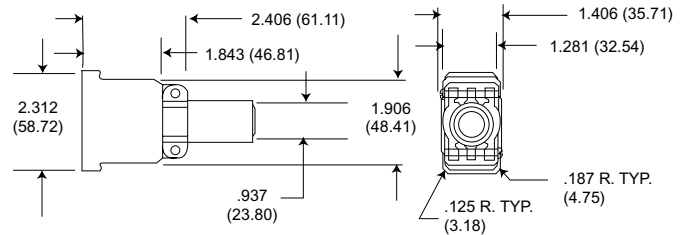

Style	Part Number
DPXA	22017

**90° Angle DPX2
Junction Shell (Side Outlet)**

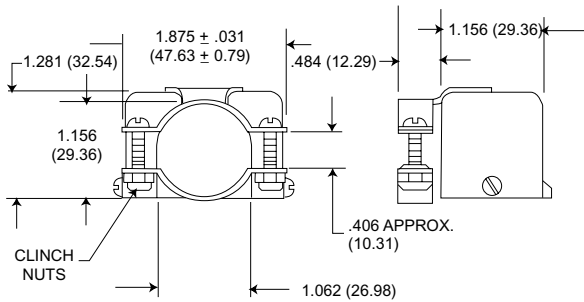

Style	Part Number
DPX2	20745-12

**(DPXA ONLY)
DIECAST STRAIGHT JUNCTION SHELL (LONG)**

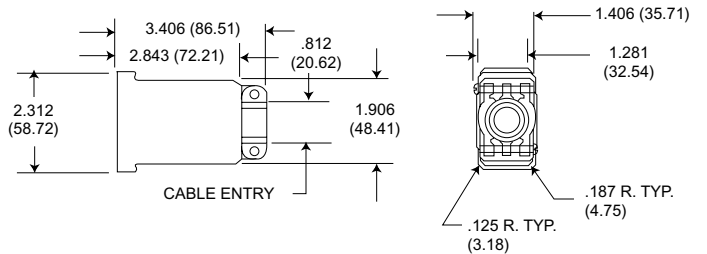

Style	Part Number
DPXA	22017-2

**(DPXA ONLY)
DIECAST 90° ANGLE JUNCTION SHELL**

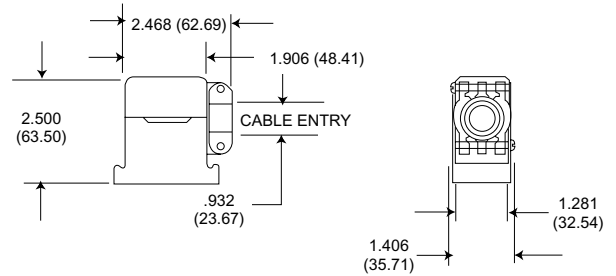

Style	Part Number
DPXA	22017-1

Diecast junction shells may be used on DPXA connectors. They have 4-40 NC-2B tapped mounting holes for attaching to the shell mounting hardware.

STRAIGHT JUNCTION SHELL

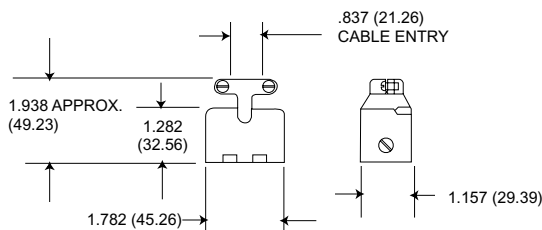

Style	Part Number
DPXA	20745-21
DPX2	20745-8

* DPX2 Junction Shells are also used on DPXB connectors.

Dust Caps



DPXA-60 for 34 Shells
025-0762-000

DPXB-60 for 34 Shells
025-0767-000

Conductive

DPXB-60-1 for 34 Shell
Conductive Dust Caps
025-0767-001
Protect Against
Static Electricity



DPXA-59 for 33 Shells
225-0749-000
Also used on DPXB-33

Conductive

DPXA-59 for 33 Shell
025-0749-001

Sealing Plugs

P/N 225-0090-000 only
Material: Teflon

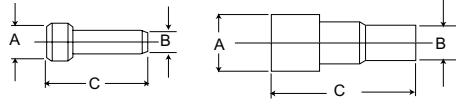

Part Number	Contact Size	Color	A	B	C
225-1013-000	22	Black	.063 (1.6)	.040 (1.0)	.469 (11.9)
225-0070-000	20	Red	.085 (2.2)	.065 (1.6)	.469 (11.9)
225-0071-000	16	Blue	.115 (2.9)	.075 (1.9)	.469 (11.9)
225-0072-000	12	Yellow	.171 (4.3)	.121 (3.1)	.564 (14.3)
225-0090-000	#5 and #9 Coax	White	.365 (9.3)	.287 (7.3)	.835 (21.2)

Filler Plugs

P/N 225-0099-000 only
Material: Thermoplastic

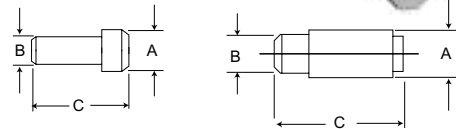

Part Number	Contact Size	Color	A	B	C
225-0094-000	22	Black	.069 (1.7)	.051 (1.3)	.420 (10.7)
225-0095-000	20	Red	.083 (2.1)	.069 (1.7)	.350 (8.9)
225-0096-000	16	Blue	.131 (3.3)	.108 (2.7)	.320 (8.1)
225-0097-000	12	Yellow	.187 (4.7)	.156 (4.0)	.320 (8.1)
225-0098-000	#5 Coax (Pin)	White	.275 (7.0)	.251 (6.4)	.450 (11.4)
225-0099-000	#5 and #9 Coax (Socket)	White	.275 (7.0)	.251 (6.4)	1.061 (26.9)

(See Customer Use Drawing for details)

DPXA - Single Shell DPX

DPXA connectors are one-piece shell miniature rack/panel connectors. The construction offers high strength and maximum utilization of insert area for contact arrangements accommodating up to 106 contacts. Shells are keystone-shaped for polarization. Operating temperature for the DPXA is -54.2°C to +125°C (-67°F to +257°F).



DPXA-34



DPXB-33

DPXB - Polarized ARINC Shell

DPXB connectors are DPXA connectors with an ARINC B shelf. Additional polarization is provided by three hexagonal polarizing posts.

DPX2 - Two Gang DPX Series

DPX2 connectors are the original two-gang versions of the DPX, and are made of the same materials and accommodate the same contact arrangements. Keystone shaped shells accommodate two DPX inserts with up to 212 contacts. The DPX2 has three polarizing posts with 99 polarizing positions.



DPX2-34



DPX2-33

DPX2 - A - ARINC A Shell

DPX2-A connectors are DPX2 connectors with an ARINC A shell. This shell type has the receptacle flange placed .344 (8.74) from the front of the engaging portion of the shell, and short aluminum alloy polarizing posts permit polarization before contacts engage.

DPX2-B - ARINC B Shell

DPX2-B connectors supersede the DPX2-A and have an ARINC B Shell. This Shell type has the

receptacle flange placed .060 (1.52) from the front of the engaging portion of the shell, and polarizing posts permit polarization before the shells engage.

DPX3 - Three Gang DPX Series

DPX3 connectors are three-gang versions of the DPX, made of the same materials, and accommodate the same contact arrangements. The three-gang version can therefore accommodate up to a total of 318 in the keystone shaped shells, with three polarizing posts that are capable of providing up to 99 polarizing positions.



DPX3-33

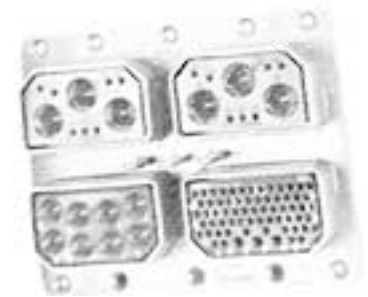

DPX4-33

DPX4 - Four Gang DPX Series

DPX4 connectors are four gang versions of the DPX, made of the same materials, and can accommodate four separate arrangements that can total up to 424 contacts. The DPX4 has three polarizing posts with 99 polarizing positions.

DPX*MA - LITTLE CAESAR® Contact Assembly

DPX*MA connectors are DPX connectors with the LITTLE CAESAR contact assembly for rear insertion, release, and extraction of crimp type contacts. Insertion requires no tool; extraction requires an expendable plastic tool. A hard dielectric, closed-entry socket insert has lead-in chamfers for positive mating of contacts. Contacts are crimpable with the M22501 tool.

DPX*ME - Environmental with LITTLE CAESAR® Contact Assembly

DPX*ME connectors are DPXMA connectors with environmental interfacial and grommet seals, and olive drab shell finish.

Performance and Material Specifications (DPXA/DPXB/DPX*MA/DPX*ME)

		DPXA/DPXB/DPX2	DPX*MA/DPX2*MA/ME	Specifications
Shell	Material	Aluminum alloy	Aluminum alloy	QQ- A-591/A380
	Finish	Cadmium plate with yellow chromate	Cadmium plate with yellow chromate for MA; olive drab for ME	QQ-P-416
Insulator	Material	Melamine or Phenolic	Diallyl phthalate or epoxy	MIL-M-14
	Material	Copper alloy	Copper alloy	QQ-C-533
Contacts	Finish	Gold	Gold	MIL-G-45204
	Termination	Solder Pot	Crimp	N/A
	Material	Die Cast	Die cast	
Polarizing Posts	Finish	Cadmium	Cadmium	QQ-P-416
	Material	Steel	Steel	QQS-630-637
Screws & Lockwashers	Material	Steel	Steel	QQS-630-637
	Finish	Cadmium Plate	Cadmium plate	QQ-P-416
Seals	Material	N/A	Silicone	N/A

How to Order

DPXA/DPXB

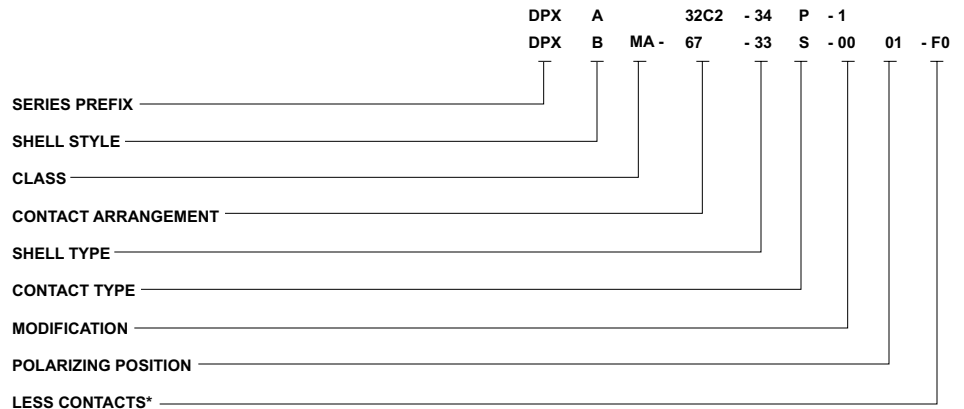

SERIES PREFIX
DPX - ITT Cannon designation

SHELL STYLE
A - Single shell
B - Polarized ARINC shell

CLASS
No designator - Solder type
MA - Crimp type with LITTLE CAESAR contact assembly
ME - Environmental crimp type

CONTACT ARRANGEMENT
2 thru 106 (see pages 48-52)

SHELL TYPE
33 for plug; 34 for receptacle

CONTACT TYPE
P for pin; S for socket

MODIFICATION
DPXA - See page 64
DPXB - See pages 64-67

POLARIZING POSITION
For DPXB shell style only

DPX2

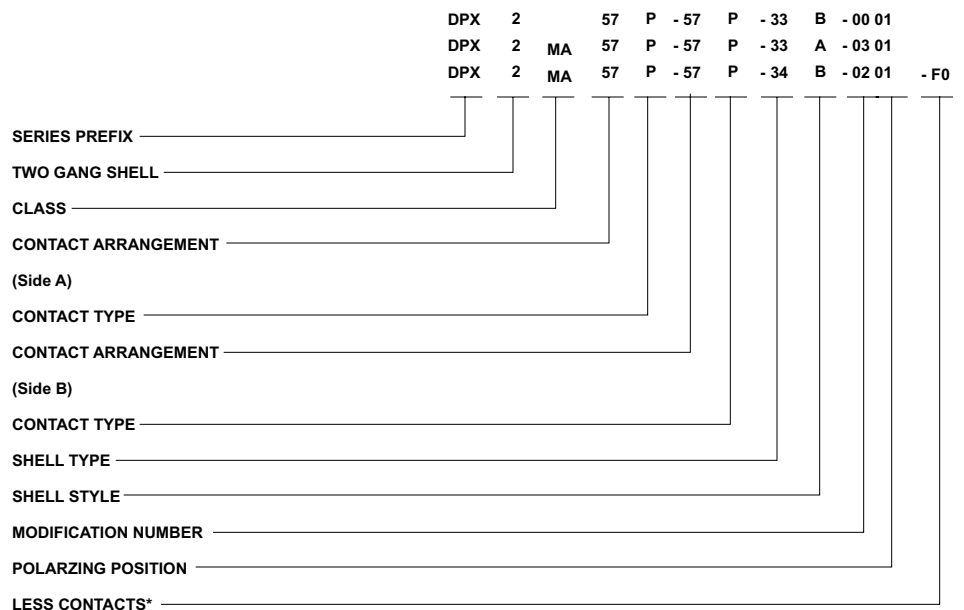

SERIES PREFIX
DPX - ITT Cannon designation

SHELL
2 - Two gang

CLASS
No designator - Solder type
MA - Crimp type with LITTLE CAESAR contact assembly
ME - Environmental crimp type

CONTACT ARRANGEMENT
2 thru 106 (see pages 48-52)

CONTACT TYPE
P for pin; S for socket

SHELL TYPE
33 for plug; 34 for receptacle

SHELL STYLE
No designator - original two-gang DPX
A - ARINC A shell
B - ARINC B shell

MODIFICATION
See pages 64-67

POLARIZING POSITION
See pages 67-68

How to Order

DPX3/DPX4

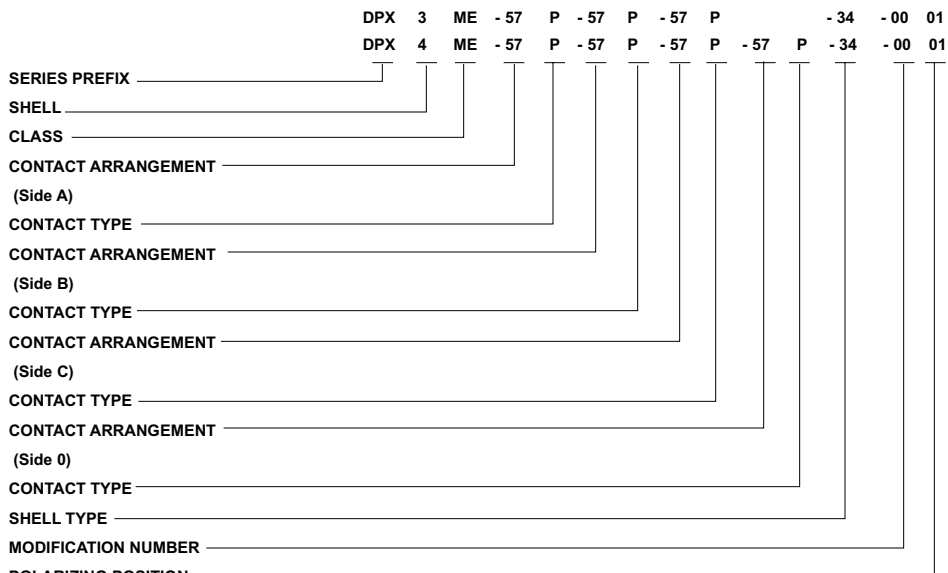

SERIES PREFIX

DPX - ITT Cannon designation

SHELL

3 - Three gang 4 - Four gang

CLASS

MA - Crimp type contacts in LITTLE CAESAR contact assembly
ME - Environment-resistant, crimp type contacts

*CONTACT ARRANGEMENT

See pages 48-49 for applicable arrangements. Please specify each arrangement number as indicated in ordering nomenclature for 3 or 4 gang if not listed below.

POLARIZING POSITION

**CONTACT TYPE
P for pin; S for socket. Designation follows each arrangement as ordered for 3 or 4 gang versions.

SHELL TYPE

33 for plug; 34 for receptacle

MODIFICATION NUMBER See pages 64-67

POLARIZING POSITION See pages 67-68

DPXMA/ME

DPXMA/DPXME - 0PX - 3 Shell Layouts

Layout	Insert - Used in shell position as noted					
	MA:	W8	32W4	57	67	A106
	ME:	AW8	A32W4	57	67	A106
*E24		A,B,C				
*F122		A,B				C
G122		B		A,C		
*E142		C			A,B	
*A166			C		A,B	
171				A,B,C		
201					A,B,C	
*C205			C		A	B
B240					A,C	B
C240					A,B	C
*D244			C			A,B
A279					C	A,B
A318						A,B,C

*Applicable to "ME" only. Consult factory for similar layouts application to "MA."
NOTE: For pictorial views of above layouts see pages 50-51.

DPXMA/DPXME - 0PX - 4 Shell Layouts

Layout	Insert - Used in shell position as noted							
	MA:	W8	26	32W4	57	67	A106	None
	ME:	AW8	26	A32W4	57	67	A106	None
145			A,B,C			D		
*B148		C,D	B				A	
B150		A,B			A,C	C,D		
*181		B				A	C	D
*B189		C,D				B	A	
*A198				C,D	A,B,C	A,B		
268						A,B,C,D		
*E287		D				B	A,C	
*220		B					C,D	A
*A233				A		B,C,D		
279						A	C,D	B
*F287		B				A	C,D	
*E326		B					A,C,D	
A346						C,D	A,B	
B346						A,B	C,D	
385						A	B,C,D	
A424							A,B,C,D	

Single Gang

DPXA-33

All tolerances $\pm .015(0.38)$ unless otherwise noted.

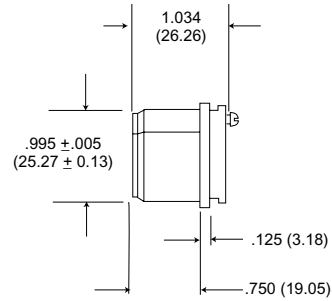
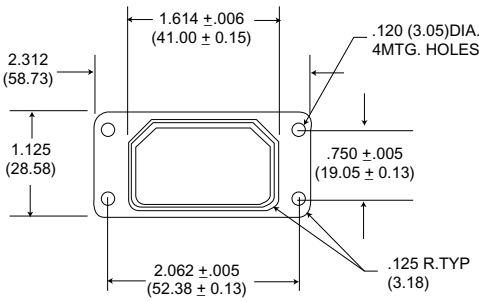

DPXA-34

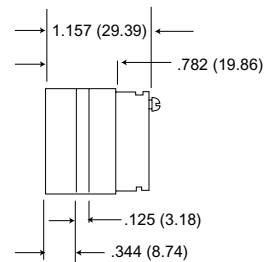
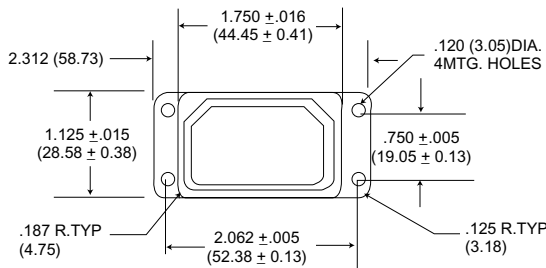

DPXA-33 ARINC Shell

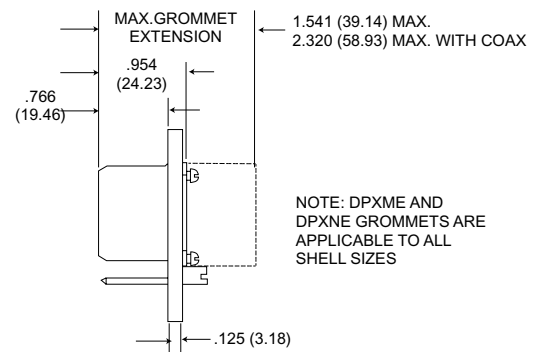
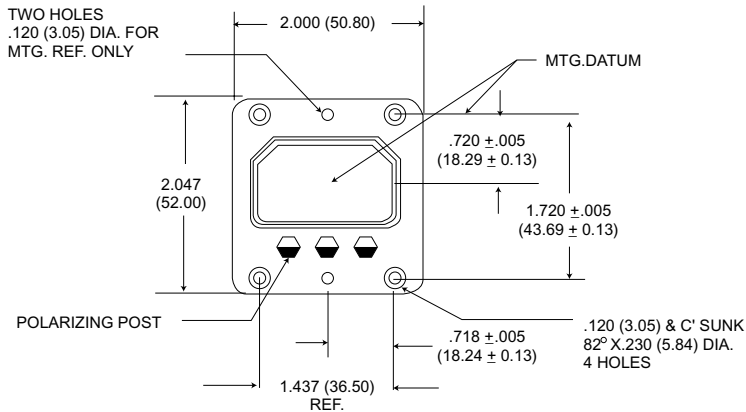

DPXA-34 ARINC Shell

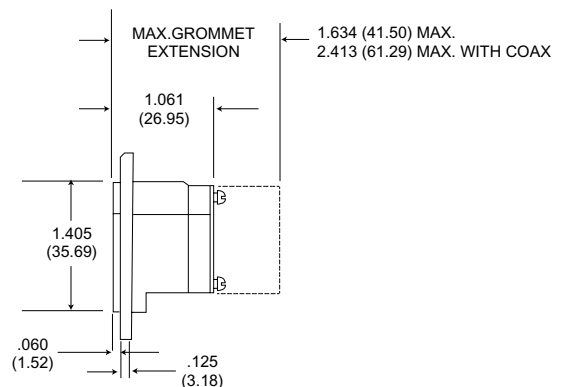
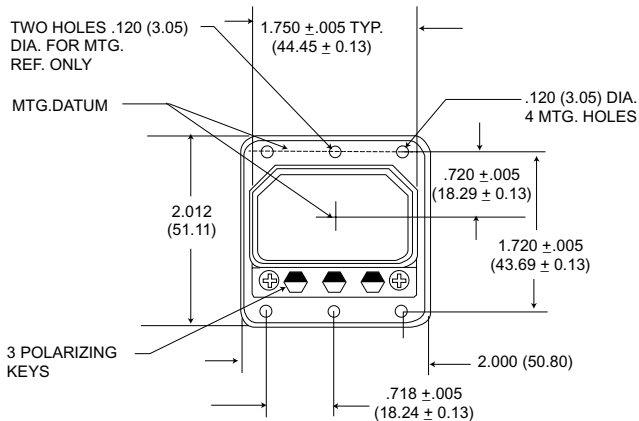

NOTE - ARINC requires that DPXB shells are mounted with the polarizing posts at the top. See pages 67-68

Two Gang

DPX2-33 Shell

All tolerance are $\pm .015$ (0.38) unless otherwise noted.

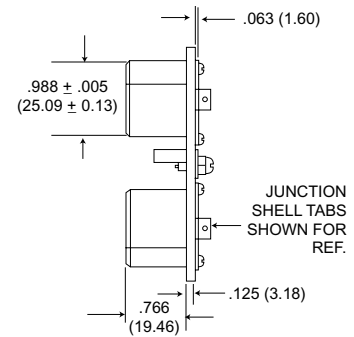
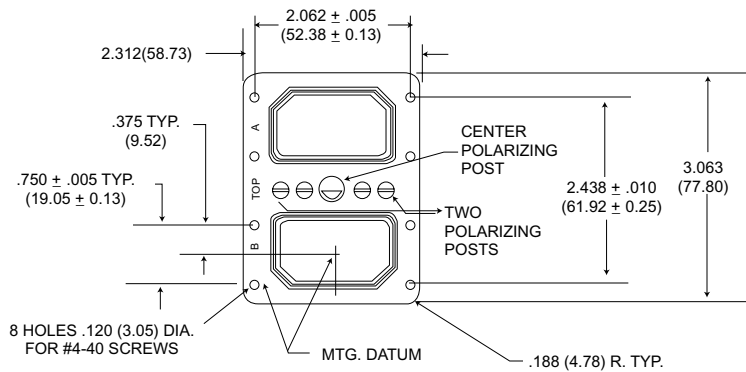

DPX2-34 Shell

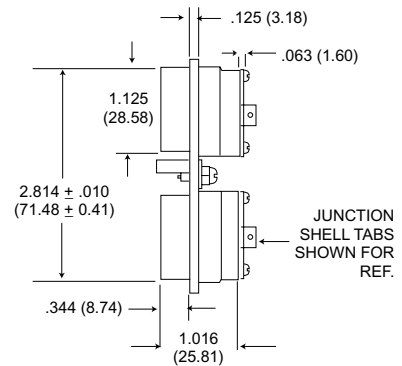
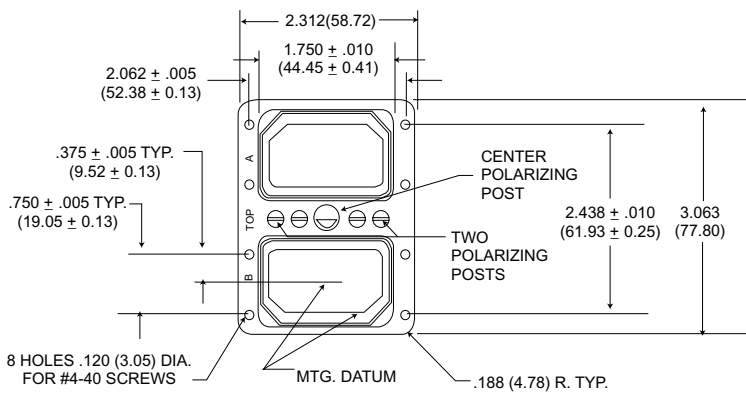

DPX2-33A ARINC A Shell

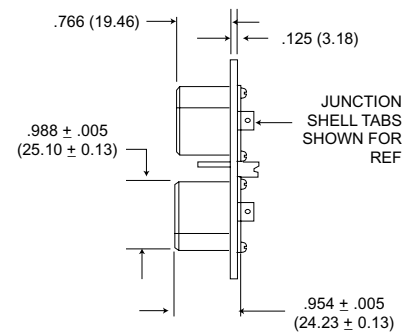
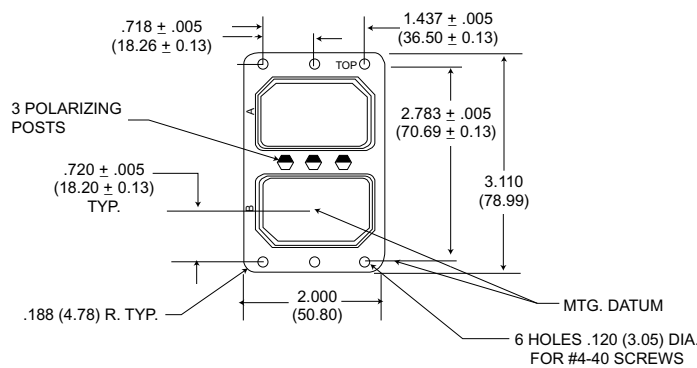

DPX2-34A ARINC A Shell

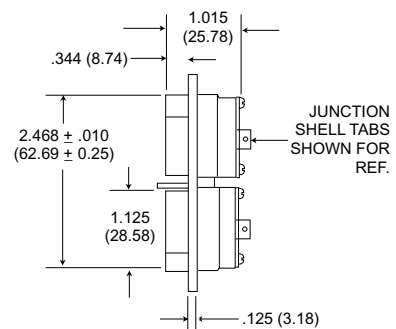
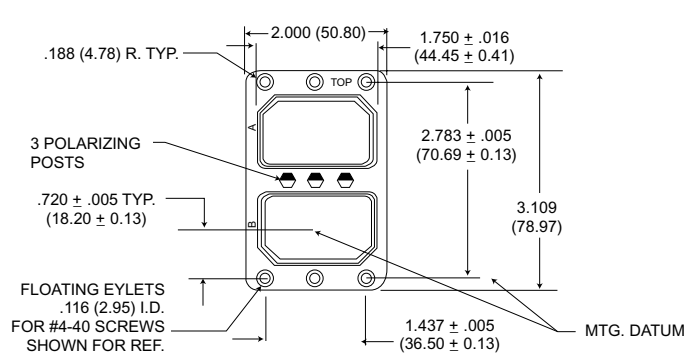

Two Gang - ARINC B Shell

DPX2-33B

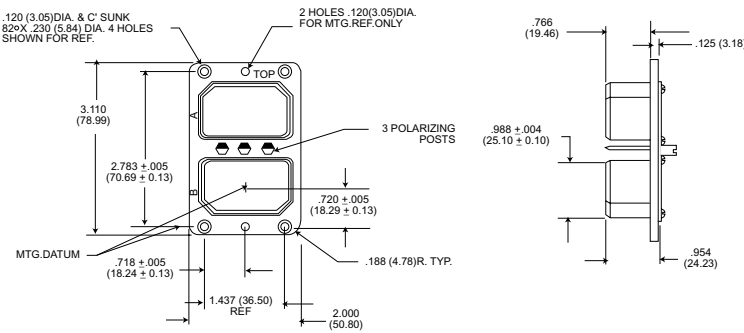

DPX2-34B

All tolerances are ± .015(0.38) unless otherwise noted.

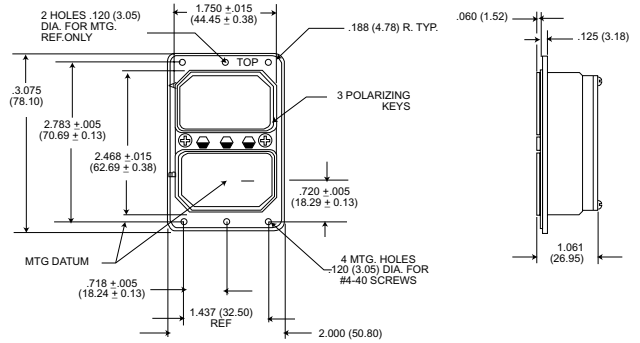

Two Gang - Screw Coupling

DPX2-33F (Female)

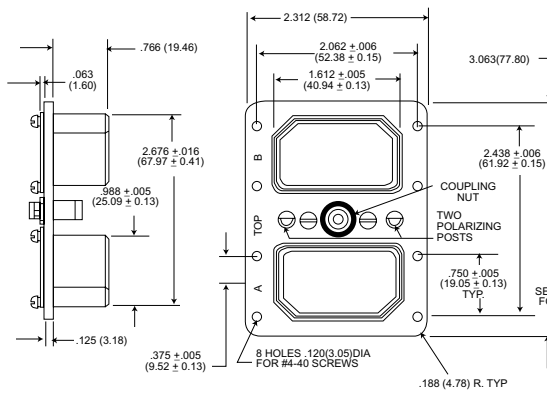

DPX2-34M (Male)

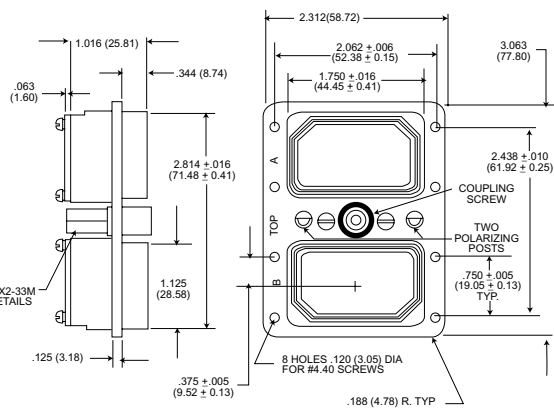

DPX2-34F (Female)

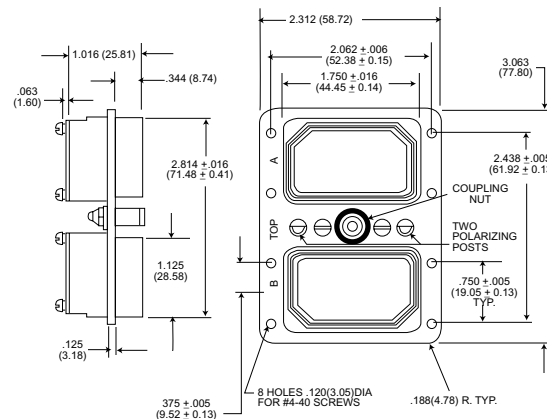

DPX2-33M (Male)

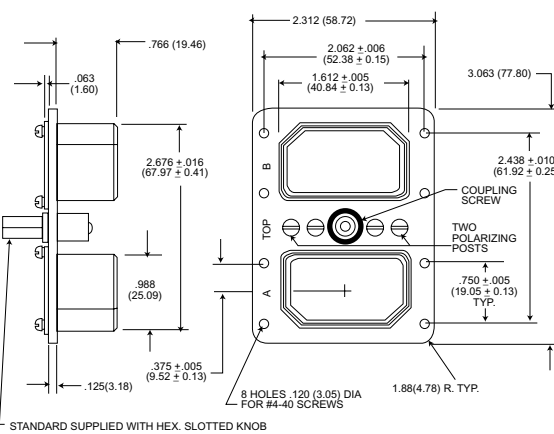

Engaging Devices

DPX2-34M with wing handle type -0901; example, DPX2-34M-0901

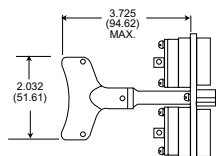

DPX2-34M with extended hex, knob type -0501; example, DPX2-34M-0501

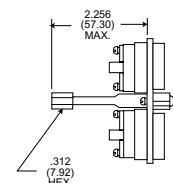

Two Gang - ARINC B Shell

DPX3-33

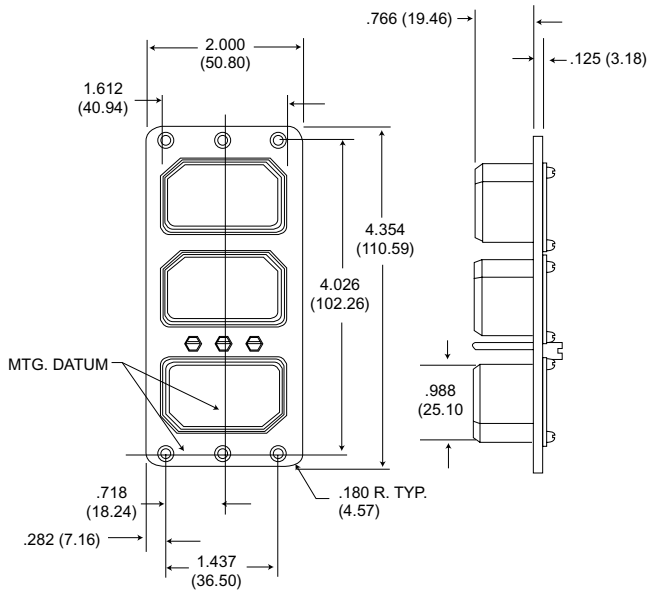

DPX3-34

All tolerances are ± .015(0.38) unless other wise noted.

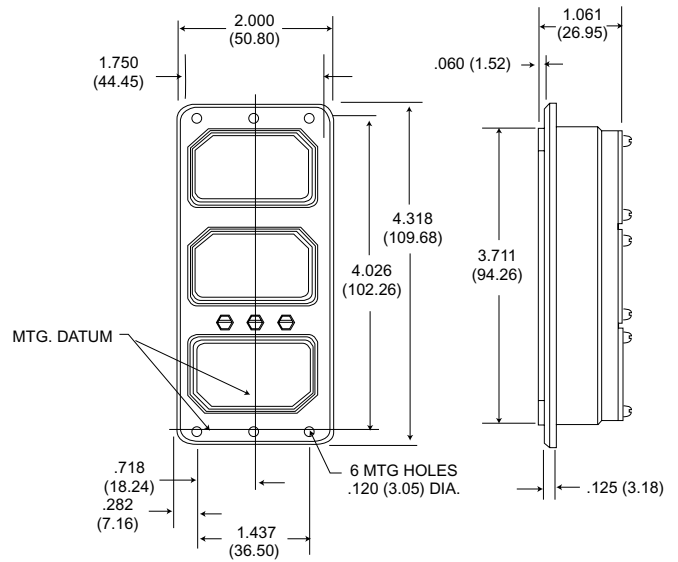

Four Gang

DPX4-33

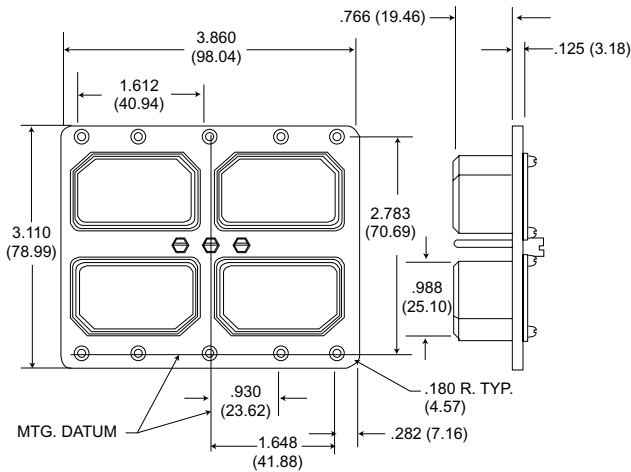

DPX4-34

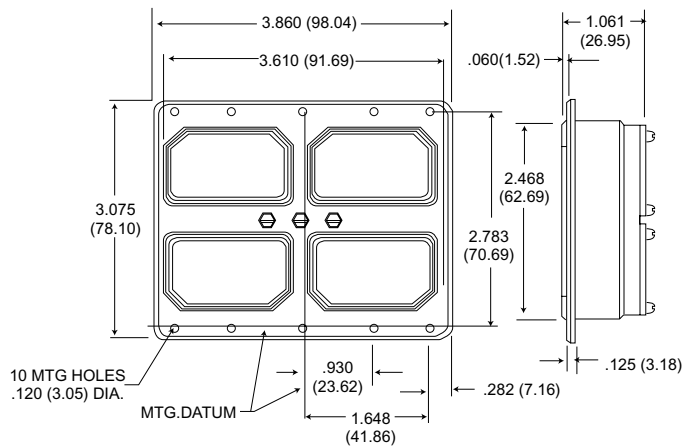

Contact Arrangement Variations Solder Type (Captive Contacts)

NOTE: See pages 55-56 for Coaxial/Power Contact Termination Data

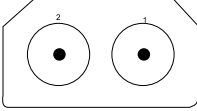
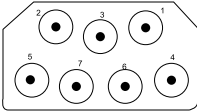
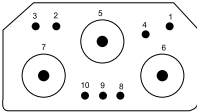
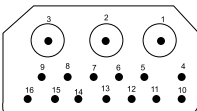
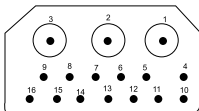
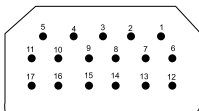
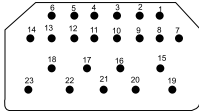
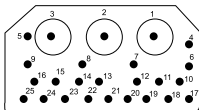
Contact Arr.	No. of Contacts & Wire size	Test Voltage AC (RMS)	Contacts Arr. No.	PIN			SOCKET		
				No. of Contacts	Contact Type Code	Contact Numbers	No. of Contacts	Contact Type Code	Contact Numbers
C2 	2 coax (RG-9/U)	1000 (1,2)V matched impedance	C2	2	R	1-2	2	R	1-2
			C2C	2	AB	1-2	Consult Factory		
			C2M	Consult Factory			2	AC	1-2
			C7	7	K	1-7	4	F G	1,2,4,5 3,6,7
C7 	7 coax	1000 (1-7)V	C7A	7	A	1-7	Same as Pin		
			C7B	7	B	1-7	Same as Pin		
			Same as Socket			7	K	1-7	
			C7B	(Use C7)					
			C7M	7	C	1-7	Same as Pin		
			C7X	7	AA	1-7	Same as Pin		
			C7AA	7	Z	1-7	Same as Pin		
8* 	8 #12	2000V	8	N	1-8	8	0	1-8	
10C3* 	7 #20 3 coax	1500 (1-4, 8-10)V	10C3	7	L	1-4, 8-10	Same as Pin		
				3	I	5,6,7			
			A10C3	7	L	1-4, 8-10	Same as Pin		
				3	J	5,6,7			
B16C3* 	13 #16 3 coax	1500 (4-16)V 1000 (1-3)V	B16C3	13	M	4-16	Same as Pin		
				3	A	1-3			
			C16C3	13	M	4-16	Same as Pin		
				3	B	1-3			
			G16C3	13	M	4-16	Same as Pin		
				3	C	1-3			
			J16C3	13	M	4-16	Same as Pin		
				3	K	1-3			
ZE16C3	13	M	4-16	Same as Pin					
	3	Z	1-3						
ZF16C3	13	M	4-16	Same as Pin					
	3	AA	1-3						
17 	17 #20	2000V	17	17	L	1-17	Same as Pin		
23 	23 #20	2000 (15-23). 1500 (1-14)V.	23	23	L	1-23	Same as Pin		
			25C3	22	L	4-25	22	L	4-25
25C3* 	22 (#20). 3 coax	1500 (4-25)V. 1000 (1-3)V		3	K	1-3	2	F	1,3
				1	G	2			
			F25C3	22	L	4-25	Same as Pin		
				3	C	1-3			
			G25C3	22	L	4-25	Same as Pin		
				3	A	1-3			
			J25C3	22	L	4-25	Same as Pin		
				3	B	1-3			
Q25C3	22	L	4-25	Same as Pin					
	3	Z	1-3						
R25C3	22	L	4-25	Same as Pin					
	3	AA	1-3						

Contact Arrangement Variations Solder Type (Captive Contacts)

NOTE: See pages 55-56 for Coaxial/Power Contact Termination Data

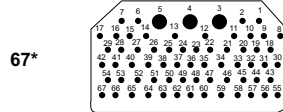
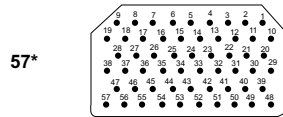
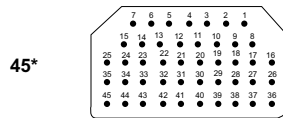
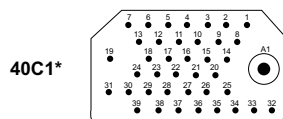
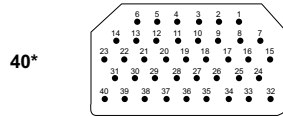
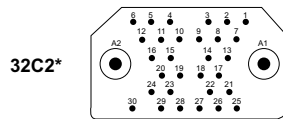
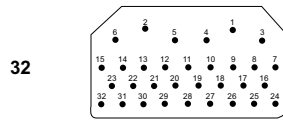
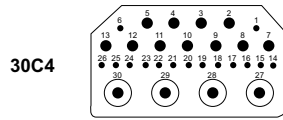
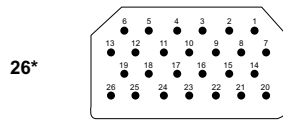

Contact Arr.	No. of Contacts & Wire Size	Test Voltage AC (RMS)	Contact Arr. No.	PIN			SOCKET													
				No. of Contacts	Contact Type Code	Contact Numbers	No. of Contacts	Contact Type Code	Contact Numbers											
26*	26 #16	1500V	26	26	M	1-26	Same as Pin													
30C4	15 #20. 11 #16, 4 coax	1500 (2-5 & 7-13)V 1000 (1,6 & 14-26)V	30C4	15	L	1,6 14-26	30C4	Same as Pin												
				11	M	2-5, 7-13														
				4	Z	27-30														
				15	L	1,6 14-26														
				11	M	2-5, 7-13														
				4	AA	27-30														
32	3 #16 29 #20	2000 (1-6) 1500 (7-32)V	32	29	L	1,3,4,7-32	32	Same as Pin												
				3	M	2,5,6														
32C2*	30 #20 2 coax	1500 (1-30)V 1000 (A1, A2)V	32C2	30	L	1-30	32C2	Same as Pin												
				2	K	A1, A2														
				30	L	1-30														
				2	A	A1, A2														
				30	L	1-30														
				2	B	A1, A2														
40	40 #20	1500V	40	40	L	1-40	40	Same as Pin												
				40C1	39 #20 1 coax	1500 (1-39)V 1000 (A1)V			40C1	39	L	1-39	40C1	Same as Pin						
										1	B	A1								
										39	L	1-39								
										1	K	A1								
										39	L	1-39								
1	C	A1																		
45*	45 #20	1500V	45	45	L	1-45	45	Same as Pin												
				57	57 #20	1500V			57	57	L	1-57	57	Same as Pin						
										67	64 #20 3 #16	1000V			67	64	L	1-2,6-65	67	Same as Pin
																3	M	3-5		

Contact Arrangement Variations, Crimp Type - DPX*MA/ME Series

NOTE: See pages 58-61 for Coaxial Contact data
See pages 53-54 for Crimp Contact data

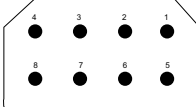
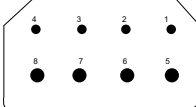
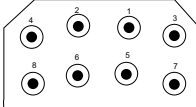
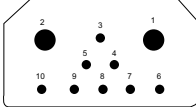
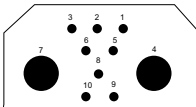
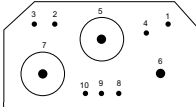
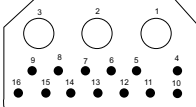
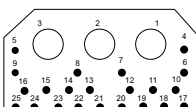
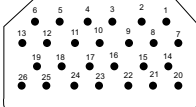
	Contact Arr.	No. of Contacts & Wire Size	Test Voltage AC (RMS)	Contact Arr. No.	No. of Contacts	Contact Size or Code Letter	Contact Numbers
8		8 #12		8	8	12	1-8
D8		4 #16, 4 #12		D8	4	16 12	1-4 5-8
W8**		8 coax	1000V (1-8)V	W8 C8A C8B C8C C8E C8G C8H	8	coax G F H R S AB	1-8
10		2 #8, 8 #20	1500V	10	2 8	B 20	1,2 3-10
A10		8 #16, 2 #4	1500V	A10	8 2	16 4	1-3, 5, 6, 8-10 4, 7
10W3**		7 #20, H.D., 3 coax	1500 (1-4, 8-10)V	10W3 A10C3 B10C3	7 3 7 3 7 3	20 H.D. coax 20 H.D. AC 20 H.D. AC	1-4, 8-10 5-7
B16W3**		13 #16, 3 coax	1500 (4-16) 1000 (1-3)V socket side only (Not available in ME series)	B16W3	13 3	16 coax	4-16 1-3
25W3		22 (#20) 3 coax	1500 (4-25)V, 1000 (1-3)V (Not available in ME series)	25W3 25A3 25B3 25D3	22 3 22 3 22 3	20 coax 20 C 20 D 20 B	4-25 1-3
26		26 #16	1500V	26	26	16	1-26

**Crimp rear release coaxial contacts.

Contact Arrangement Variations, Crimp Type - DPX*MA/ME Series

NOTE: See pages 58-61 for Coaxial Contact data
See pages 53-54 for Crimp Contact data

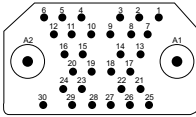
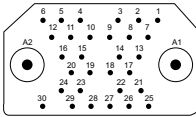
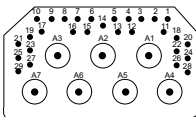
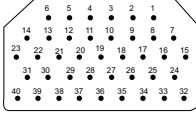
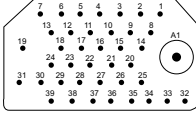
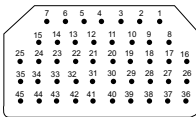
Contact Arr.	No. of Contacts & Wire Size	Test Voltage AC (RMS)	Contact Arr. No.	No. of Contacts	Contact Size or Code Letter	Contact Numbers		
 <p>32W2</p>	<p>32W2** (For MA) A32W2 (For ME)</p> <p>30 #20, 2 coax</p>	<p>1500 (1-30), 1000 (A1,A2)V</p>	32W2	30 2	20 coax			
			32A2	30 2	20 B			
			32B2	30 2	20 A			
			32C2	30 2	20 D	1-30 A1,A2		
			D32C2	30 2	20 J			
			32F2	30 2	20 P			
			32G2	30 2	20 C			
			32W4	4 24	coax 20 H.D.			
 <p>32W4</p>	<p>32W4** (For MA) A32W4 (For ME)</p> <p>24 #20 H.D. 4 #16, 4 coax</p>	<p>1500 (1-28), 1000 (29-32)V</p>	32C4	4 24 4	S 20 H. D. 16			
			B32C4	4 24	H 20 H. D. 16			
			C32C4	4 24 4	R 20 H. D. 16	29-32 1-7, 10-22 25-28 8, 9, 23, 24		
			D32C4	4 24 4	G 20 H. D. 16			
			E32C4	4 24 4	AA 20 H. D. 16			
			H32C4	4 24 4	AB 20 H. D. 16			
			 <p>36W7</p>	<p>36W7**</p> <p>29 #22 H.D. 7 coax (Size 5)</p>	1000			
			 <p>40</p>	40 #20	1500V	40	40	20
 <p>40W1</p>	<p>40W1** (For MA) A40W1 (For ME)</p> <p>39 #20, 1 coax</p>	<p>1500 (1-39) 1000 (A1)V</p>	40W1	39 1	20 coax			
			40B1	39 1	20 B	1-39 A1		
			40F1	39 1	20 P			
			F40C1	39 1	20 J			
 <p>45</p>	45 #20	1500V	45	45	20	1-45		

**Crimp rear release coaxial contacts.

Contact Arrangement Variations, Crimp Type - DPX*MA/ME Series

NOTE: See pages 58-61 for Coaxial Contact data
See pages 53-54 for Crimp Contact data

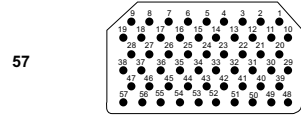

57

Contact Arr.	No. of Contacts & Wire Size	Test Voltage AC (RMS)	Contact Arr. No.	No. of Contacts	Contact Size or Code Letter	Contact Numbers
57	57 #20	1500V	57	57	20	1-57

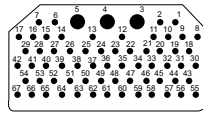

67

67	64 #20 H.D. 3 #16	1500 (3-5) 1000 (1, 2, 6-67)V	67	64 3	20 H.D. 16	1-2, 6-67 3, 4, 5
----	----------------------	-------------------------------------	----	---------	---------------	----------------------

A106†

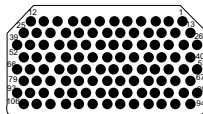

A106†	106 #22	1000V	A106	106	22	1-106
-------	---------	-------	------	-----	----	-------

**Crimp rear release coaxial contacts.

†A106 arrangements have the POS-ALINE connector design. See below.

NOTE: Engaging force of each layout arrangement shall not exceed 45 lbs. maximum.

Positive Contact Alignment Design

For high density A106 contact arrangement

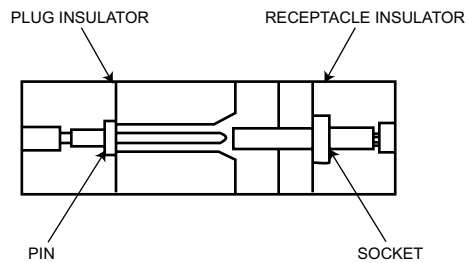

In the POS-ALIGN connector construction the entire pin contact is recessed in an individual cavity in the plug insulator while the sturdy socket members are exposed and extend from the connector receptacle face. There is a lead-in chamfer that guides the socket contact into the pin cavity assuring proper contact alignment during mating and protecting the pin contact from damage and wear.

Contact and Termination Tooling Data - Commercial

Crimp Contacts

The crimp contacts are shipped with the connector, not installed. Additional contacts may be ordered using the part numbers listed below. All tools must

be purchased separately. The insertion/extraction tools listed are plastic type. Consult factory for more durable metal tools.

Contact Size	Type	Part Number		Wire Accom.	Crimp Tool Part Number	Locator Part Number	Insertion/ Extraction Tool (Part No.)	Layout Usage	
		DPX MA Commercial	DPX ME Commercial ¹					DPX ME	DPX MA
2222	Pin	030-1975-007	030-1975-005	22,24,26	M22520/2-01	M22520/2-23	CIT-DPXMA-22 M81969/1-01	A106	A106
	Socket	031-1113-007	031-1113-008						
2020	Pin	030-9081-000	030-2040-000	20,22,24	M225-20/1-01 MS-3191-1 MS-3191-3	M22520/2-08 Std. Locator Std. Locator	CIET-20 (274-7001-000)	10, A32W2, 40, A40W1, 45,57	10, 25W2, 32W2 40, 40W1, 45,57
	Socket	031-9134-001	031-1046-002						
2020HD	Pin	030-9081-003	030-1892-002	20,22,24	M22520/2-01 MS-3191-1	M22520/2-08 Standard	CIET-20 M81969/1-02 (980-0004-805)	10W3 A32W4, 67	10W3 32W4, 67
	Socket	031-9134-004	031-1047-002						
1616	Pin	030-9083-001	030-1893-002	16,18,20	M22520/1-01 MS-3191-1	M22520/1-02 Std. Locator	CIET-16 (274-7002-000)	D8, A10, 26, A32W4, 67	D8, A10, B16W3, 26, 32W4, 67
	Socket	031-9206-004	031-9206-021						
1212	Pin	030-1909-001	030-2045-000	12,14	M22520/1-01	M22520/1-11	CIET-12 (274-7003-000)	D8	8, D8
	Socket	031-1059-001	031-1059-002						
0808	Pin	030-1908-001	030-1908-001	8	CBT-600* CBT600B*	CCH8-1 Head CCHP-8-6	CET-8-2 (323-7004-000)	10	10
	Socket	031-1154-000	031-1154-000						
0406	Pin	030-2049-000	030-2049-000	6	CBT-600* CBT600B*	CCH4-1 Head CCHP-4-8	CET-4-8 (323-7008-000)	A10	A10
	Socket	031-1151-000	031-1151-000						

* Requires air line pressure of 80 to 100 psi.

These DPXME contacts are being superseded in favor of military DPXNE/NA contacts, this applies to all existing DPXME connector assemblies, except for size 20 contacts.

Electrical Data

Contact Size	Wire Size	Insulation (O.D.) Limits Inch (mm) Max.	Test Current per MIL-C-39029 Table VI	Max. Current for Tests (Amps) (Mil-C-39029)	Max. Potential Drop (Millivolts) at 25°C per MIL-C-39029
4	6	.310 (7.87)	60	60	33
8	8	.250 (6.35)	46	46	39
12	12	.135 (3.43)	23	23	63
	14		17	17	60
	16		13	13	68
16	18	.103 (2.62)	-	-	-
	20		7.5	-	75
	20		7.5	7.5	83
20	22	.071 (1.80)	-	-	-
	24		3	3.0	68
	22		5	5.0	110
22	24	.054 (1.37)	-	-	-
	26		2	2.0	80

Description of Modification Codes for Special Connector Insert Assemblies

Class	Series	DPX Insert Type	Class	Series	DPX Insert Type	Class	Series	DPX Insert Type
None	DPXA DPXB	Two (2) pieces, solder pot.	D*	-	(MA) LITTLE CAESAR assembly, crimp pot, (Cat. A)	DPX2CA-/	-	A side: (MAS) LITTLE CAESAR assembly, solder pot (32W2S)
MA	DPXAMA DPXBMA	LITTLE CAESAR rear release contact retention assembly, crimp pot.	E*	-	Metal plates.	DPX2AC-	-	B side; Standard 2 Piece, solder pot (57S).
MAS	-	LITTLE CAESAR assembly, solder pot.	F*	-	Rear release, crimp (MB type only).	(Reverse CA)	-	Ex: DPX2CA-32W2S57S-33-0001
MB	-	LITTLE CAESAR rear release contact retention assembly, crimp pot, with separator.	DPX2-	-	Standard 2 pieces, solder pot, both sides, Ex: DPX2-57S57S-33-0001	DPX2AF	-	A side: Standard solder pot. B side: Rear release crimp with separator. Ex: DPX2AF-13S26S-33B-0001
MS	-	Ring-Loc, solder pot,	DPX2MA	-	Standard LITTLE CAESAR assembly, crimp pot both sides Ring-loc coax. EX:DPX2MA-57S57S-33-0001	DPX2BA	-	A side: Ring-Loc solder pot (40W1S). B Side: 2 Piece, Solder Pot (57S). Ex: DPX2BA-40W1S57S-33-0001
ME	-	Environmental, connector.	DPX2MAS	-	LITTLE CAESAR assembly, solder pot, both sides Ring-Loc coax. EX: DPX2MAS-57S57S-33-001	DPX2DA	-	A side: (MA) LITTLE CAESAR assembly, Crimp (67S). B Side: 2 Piece, solder pot (57S). Ex: DPX3DA-67S57S-33-0001
A*	-	Two (2) pieces, solder pot (Standard 2 pieces insert).	DPX2MS-	-	Ring-Loc, solder pot. Layout 25C3 pin only and 40C1 Pin and socket. EX: DPX2MS-40W1S40W1S-33-0001	DPX2EB	-	A side: Metal plates for grounding (Coaxes). B side: Ring-Loc, solder pot. Ex: DPX2EB-C1P40W1P-34B-0001
B*	-	Ring-Loc, solder pot. (See MS)						
C*	-	(MAS) LITTLE CAESAR assembly, Solder pot.						

*NOTE: When any two of these letters are used in combination, the inserts ("A" and "B") side have the style contacts indicated (see table opposite for examples).

Contact and Termination Tooling Data

DPXMA (LIF) Crimp Contacts

Contact Size and Part Numbers			Crimp Tooling						Insertion/Extraction Tooling			Wire Size		
Size	Part Number		Tool P/N		Selec tor#	Locator P/N		MIL Spec	ITT Cannon		Ins./Ext.	AWG	Insul Dia. Max.	Strip Length
	Pin*	Socket*	MIL Spec	ITT Cannon		MIL Spec	ITT Cannon		Insertion	Extraction				
222	Plug 030-2259-000	Receptacle 031-1287-000	M22520	995-0001	3	M22520	995-0002	M81969	CIT-DPXMA-22-1 Metal (070256-0000)	CET-DPXMA-22 Metal (070317-0000)	(980-0004-804) Metal Tip	26 24 22	.054 (1.37)	.130/.110 (3.30/2.54)
			/2-01	-584	4	2-23	-015	/1-01						
2020HD	Receptacle 030-2273-000	Plug 031-1302-000	M22520	995-0001	6	M22520	995-0001	M81969	-	-	(980-0004-805) Metal Tip	22 20	.071 (1.80)	.167/.147 (4.24/3.73)
			/2-01	-584	7	/2-08	-604	/1-02						
1616	Receptacle 030-2280-000	Plug 031-1303-000	M22520	995-0001	4	M22520	995-0001	M81969	-	CET-16-9 Plastic (323-7001-000)	(980-0004-806) Metal Tip	20 18 16	.103 (2.62)	.270/.230 (6.86/5.84)
			1-01	-585	6	/1-02	-736	/1-03						
1212	Receptacle 030-2286-000	Plug 031-1308-000	M22520	995-0001	7	M22520	995-0002	M81969	-	CET-12-4 Plastic (323-7002-000)	CIET-12 Plastic (274-7003-000)	14 12	.135 (3.43)	.270/.230 (6.86/5.84)
			1-01	-585	8	/1-11	-027	/14-04						

* Used in Plug or Receptacle as noted below.

DPXMA Thermocouple Contacts

Contact Size and Part Numbers			Crimp Tooling						Insertion/Extraction Tooling			Wire Size		
Size	Part Number		Tool P/N		Selec tor#	Locator P/N		MIL Spec	ITT Cannon		Ins./Ext.	AWG	Insul Dia. Max.	Strip Length
	Pin*	Socket*	MIL Spec	ITT Cannon		MIL Spec	ITT Cannon		Insertion	Extraction				
2222	Plug 030-1975-009	Receptacle 031-1113-009	M22520	995-0001	3	M22520	995-0002	M81969	CIT-DPXMA-22-1 Metal (070256-0000)	CET-DPXMA-22 Metal (070317-0000)	(980-0004-804) Metal Tip	26 24 22	.054 (1.37)	.130/110 (3.30/2.54)
			/2-01	-584	4	/2-23	-015	/1-01						
2222	Plug 030-1975-010	Receptacle 031-1113-010												

Coaxial/Power Contact Termination Data (Retained by Captive Insulator Assy.)

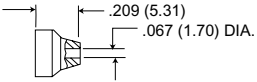
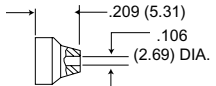
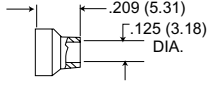
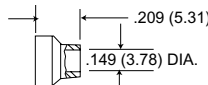
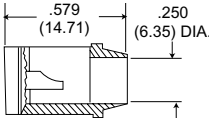
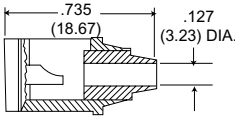
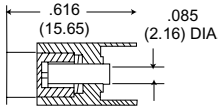
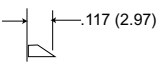
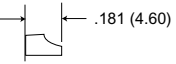
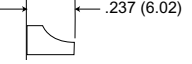
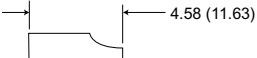
Rear Extension from insulator	Contact type code	Part Number		Cable Accommodation	Layout Accommodation
		Pin	Socket		
	A	249-0672-000	249-0671-000	RG-187/U RG-188/U	C7A, B16C3, G25C3, C30C4, A32C2, L40C1
	B	249-0702-000	249-0703-000	RG-180/U RG-195/U	C7B, J25C3, C16C3, C32C2, 40C1
	C	249-0749-000	249-0750-000	RG-55/U RG-58/U RG-223/U	C7H, G16C3, F25C3, D32C2, F40C1
	D	-	249-0518-000	RG-59/U	C7J, H16C3, H25C3, F32C2, E30C4, E40C1
	I	249-0365-000	249-0353-000	RG-7/U	10C3
	J	249-0257-000	249-0268-000	RG-55/U RG-58/U RG-223/U	A10C3
	K	249-0583-000 024-0015-000 253-0120-000	249-0591-000 024-0015-000 253-0120-000	RG-187/U RG-188/U	25C3, 32C2, J16C3, A40C1, C7, C7D
A40C1 pin only, use C40C1 for socket.					
	L	330-0144-000	330-0145-000	7.5 amp #20 wire	See Note 1
	M	030-0056-010	031-0016-008	13 amp #16 wire	See Note 2
	N	030-0017-015	-	23 amp	8
	O	-	031-0059-008	#12 wire	8

* These coaxial contacts are supplied with the connector.

Coaxial/Power Contact Termination Data (Retained by Captive Insulator Assy.)

Rear Extension from insulator	Contact type code	Part Number		Cable Accommodation	Layout Accommodation
		Pin	Socket		
	R	249-1521-000	249-1522-000	RG-9/U, RG-214/U	C2
	Z	249-1624-000	249-1598-000	RG-58/U with Captive Contact	C7AA, ZE16C3, Q25C3, A30C4, M32C2, J40C1
	AA	249-1599-000	249-1622-000	RG-196/U with Captive Contact	C7X, ZF16C3, R25C3, B30C4, N32C2, K40C1
	AB	249-1554-000	-	RG-58/U	C2C
	AC	Consult Factory	249-5027-001	RG-9/U, RG-214/U	C2M

NOTES: 1. Code L-10C3, A10C3,17, 23, 25C3, E25C3, F25C3, G25C3, H25C3,J25C3, Q25C3, R125C3, 30C4, A30C4, C30C4, D30C4, E30C4, 32, 32C2, A32C2, C32C2, 032C2, F32C2, M32C2, N32C2, Q32C2, 40, 40C1, B40C1, D40C1, E40C1, F40C1, H40C1, J40C1, K40C1, L40C1, 45, 57, 67,
 2. Code M-B16C3, C16C3, G16C3, H16C3, M16C3, ZE16C3, ZF16C3, 26, 30C4, 32, 67

Suggested Cable Trim Dimensions

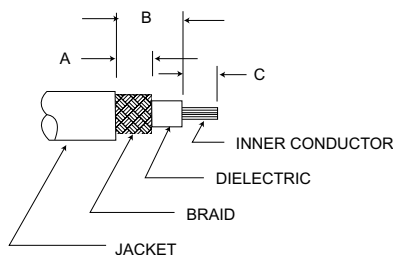

Code Letter	Inches			Millimeters		
	A	B	C	A	B	C
A	.166/.146	.358/.318	.14	4.22/3.71	9.08/8.08	3.55
B	.166/.146	.358/.318	.14	4.22/3.71	9.08/8.08	3.55
C	.166/.146	.358/.318	.14	4.22/3.71	9.08/8.08	3.55
D	.166/.146	.358/.318	.14	4.22/3.71	9.08/8.08	3.55
E	.166/.146	.358/.318	.14	4.22/3.71	9.08/8.08	3.55
I	.166/.146	.39	.166/.146	4.22/3.71	9.91	4.21/3.71
J	.166/.146	.55	.166/.146	4.22/3.71	13.97	4.21/3.71
K	.198/.178	.488/.428	.25	5.03/4.52	11.38/10.87	6.35
Z	.08	.41	.23	2.03	10.41	5.84
AA	.11	.23	.195/.175	2.79	5.84	4.95/4.45
AB	.238/.198	.233/.193	.447/.427	6.04/5.03	5.92/4.90	11.35/10.89
AC	.345/.281	.516/.484	.359/.296	8.71/7.14	13.1/12.3	9.12/7.52
R	.238/.198	.233/.193	.582/.542	6.05/5.03	5.92/4.90	14.8/13.8

Coaxial Cable Assembly

ITT Cannon recommends resistance soldering for all solder contacts, particularly for RF cable where excessive heat will damage the dielectric. Wires

should be pre-tinned. Bushing, endbells, and junction shells (where applicable) must be slipped over wire bundles before soldering is started. Consult

factory for types not shown. The mechanical steps in wiring coaxials described below.

For Codes A, B, C, D, and E

1. Cut cable evenly. Trim to dimensions as shown on page 56. Care should be taken not to injure the conductor or dielectric.
2. Remove inner contact from coaxial assembly and solder it to inner conductor of cable.
3. Push inner contact back into coaxial assembly.
4. Pull outer conductor over coaxial shell, and solder.
5. Apply shrink sleeving after assembly.

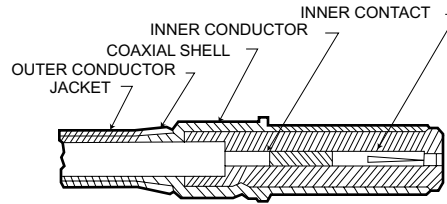

For Codes I and J

1. Cut cable evenly. Trim to dimensions as shown on page 56. Care should be taken not to injure the conductor or dielectric.
2. Comb braid, tin conductor and remove flux.
3. Remove solder pot cover. Insert cable and solder conductor to contact. The dielectric should butt against contact solder pot.
4. Replace solder pot cover and solder braid to ferrule.
5. Apply shrink sleeving after assembly.

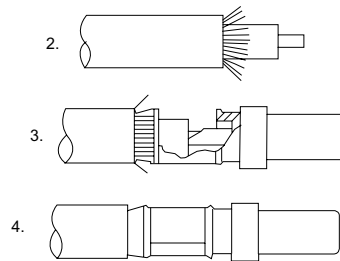

For Codes K

1. Cut cable evenly. Trim to dimensions as shown on page 56. Care should be taken not to injure the conductor or dielectric.
2. Unscrew cap and remove spacer and inner contact from coaxial assembly.
3. Push cable through center of cap and spacer.
4. Solder inner contact to inner conductor of cable.
5. Push inner contact back into coaxial shell assembly and attach cap.
6. Separate outer conductor of cables into two pigtails 180° apart.
7. Attach on pigtail to each end of cap strip and solder.
8. Apply shrink sleeving after assembly.

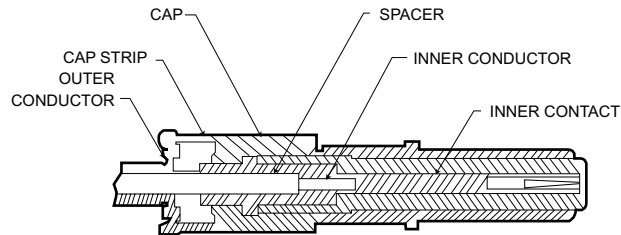

For Codes Z and AA

1. Cut cable evenly. Trim to dimensions as shown on page 56. Care should be taken not to injure the conductor or dielectric.
2. Solder inner conductor to coaxial contact through side slot in coaxial with outer sleeve pushed back on cable.
3. Pull sleeve forward over braid and solder through holes in sleeve.
4. Solder sleeve to coaxial body.

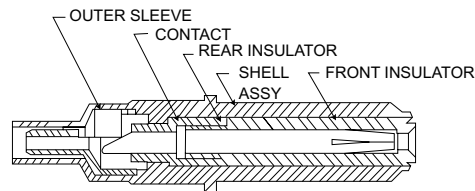

Coaxial Contacts

NOTES: 1. The "X" dimension is take from the rear of the shell.
 2. Codes G and S are inactive for new design. Use codes AD and AE.
 3. Code AA is designed for installations that have limited space in the terminal area. Use code AG for standard installations.

*P for pin; S for socket.

Codes A, B, C, D, E, H, P, R

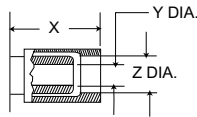

Arr. Used In	Code Letter	Cable Accommodation	Part Number*	Contact Retention	X Max.	Y Dia.	Z Dia.	Crimp Tool	Extraction Tool	
B16W3 25W3 32W2 40W1	A	*RG-59/U	P-249-1397-000	Ring Loc	.760 (19.30)	.158 (4.01)	.275 (6.53)	CA58073	CET-C4 (038869-0004)	
		RG-62/U	S-249-1398-000							
	B	*RG-58/U	P-249-1399-000	Ring Loc	.760 (19.30)	.128 (3.25)	.211 (5.36)			
			S-249-1400-000							
	C	*RG-180/U	P-249-1401-000	Ring Loc	.760 (19.30)	.128 (3.25)	.166 (4.22)			
		RG-195/U	S-249-1402-000							
	D	RG-174/U, RG-187/U	P-249-1403-000	Ring Loc	.760 (19.30)	.072 (1.83)	.121 (3.07)			CCT-HX4-524 CCT-408M
		RG-179/U, RG-188/U	S-249-1404-000							
E	RG-178/U	P-249-1405-000	Ring Loc	.760 (19.30)	.072 (1.83)	.091 (2.31)				
	RG-196/U	S-249-1406-000								
W8 32W4	H	RG-174/U, RG-187/U	P-249-1633-000	LITTLE CAESAR	.592 (15.04)	.072 (1.83)	.121 (3.07)	CCT-HX4-524 CCT-408M	CET-C8 (323-7011-000)	
		RG-179/U, RG-188/U	S-249-1634-000							
B16W3 25W3 32W2 40W1	P	*RG-58/U with nylon braid over jacket	S-249-1608-000	Ring Loc	.760 (19.30)	.128 (3.25)	.235 (5.97)	Crimp CA58073	CET-C4 (038869-0004)	
W8 32W4	R	*RG-178/U	P-249-1670-000	LITTLE CAESAR	.592 (15.04)	.072 (1.83)	.091 (2.31)	CCT-HX4-524 CCT-408M	CET-C8 (323-7011-000)	
		RG-196/U	S-249-1671-000							

***IMPORTANT: These coaxials can only be used in the DPX*MAS or DPX*MB Connector Series.**

Codes F, S, T

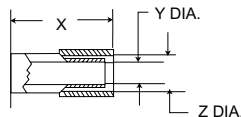

W8 32W4	F	RG-59/U	P-249-1474-000	LITTLE CAESAR	.775 (19.68)	.158 (4.01)	.238 (6.04)	CA58073 CCT-HX3-156	CET-C8 (323-7011-000)
		RG-62/U	S-249-1471-000						
	S	RG-55/U	P-249-1958-000	LITTLE CAESAR	.592 (15.04)	.130 (3.30)	.238 (6.04)	CA58073 CCT-HX3-156	CET-C8 (323-7011-000)
		RG-142/U	S-249-1959-000						
	T	RG-59/U	P-249-1960-000	LITTLE CAESAR	.592 (15.04)	.158 (4.01)	.238 (6.04)	CCT-HX3-156	CET-C8 (323-7011-000)
		RG-62/U	S-249-1961-000						

Codes G

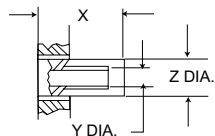

W8 32W4	G	RG-58/U	P-249-1631-000	LITTLE CAESAR	.500 (12.70)	.130 (3.30)	.211 (5.36)	CCT-HX4-524 CCT-408M	CET-C8 (323-7011-000)
			S-249-1632-000						

Codes J

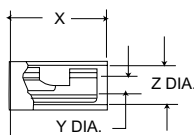

W16W3 25W3 32W2 40W1	J	RG-58/U	P-249-1388-000	Ring Loc	798 (20.27)	.130 (3.30)	.273 (6.93)	Solder	CET-C4 (038869-0004)
			S-249-1390-000						

Coaxial Contacts

CODE K

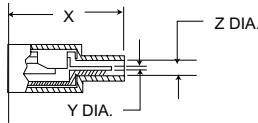

Arr. Used In	Code Letter	Cable Accommodation	Part Number*	Contact Retention	X Max.	Y Dia.	Z Dia.	Crimp Tool	Extraction Tool
B16W3	K	RG-178/U	P-249-1384-000	Ring Loc	.906 (23.01)	.045 (1.14)	.098 (2.49)	Solder	CET-C4 (038869-0004)
25W3		RG-196/U	S-249-1413-000						
32W2									
40W1									

CODE L

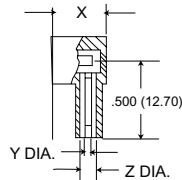

B16W3	L	RG-178/U	P-249-1386-000	Ring Loc	.518 (13.16)	.045 (1.14)	.098 (2.49)	Solder	CET-C4 (038869-0004)
25W3		RG-196/U	S-249-1414-000						
32W2									
40W1									

CODE U

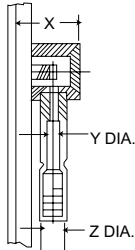

W8	U	RG-174/U, RG-187/U RG-179/U, RG-188/U	S-249-1883-000	LITTLE CAESAR	.425 (10.80)	.069 (1.75) .059 (1.50)	.117 (2.97) .107 (2.72)	CCT-C10	CET-C8 (038869-0004)
----	---	--	----------------	---------------	--------------	----------------------------	----------------------------	---------	-------------------------

CODE V, AC

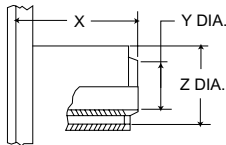

10W3	V	RG-115/U	P-249-1956-000	LITTLE CAESAR	.800 (20.32)	.260 (6.60)	.356 (9.04)	Buchanan 612991	CET 4-8 (323-7008-000)
	AC	RG-58/U	S-249-1957-000	LITTLE CAESAR	.800 (20.32)	.254 (6.45)	.349 (8.86)		
			S-249-1977-000	LITTLE CAESAR	.800 (20.32)	.205 (5.21) .199 (5.05)	.356 (9.04) .349 (8.86)		

CODE AA, AB, AD, AE, AF, AG

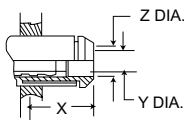

W8 32W4	AA	RG-178/U RG-196/U	P-249-1968-000	LITTLE CAESAR	.260 (6.60)	.088 (2.24) .084 (2.13)	.126 (3.20) .122 (3.10)	T & B #WT400	
	AB	RG-180/U RG-195/U	P-249-1982-000 S-249-1983-000						
	AD	RG-58/U	P-249-2017-000 S-249-2018-001						
	AE	RG-142/U	P-249-2019-001 S-249-2020-001	LITTLE CAESAR	.575 (14.60)	.114 (2.90) .104 (2.64)	.168 (4.27) .158 (4.01)	Daniels HX4-210	CET-C8 (323-7011-000)
	AF	RG-174/U, RG-187/U RG-179/U, RG-188/U	P-249-1633-004 S-249-1634-003						
	AG	RG-178/U RG-196/U	P-249-2061-000 S-249-2062-001						

DPX*MA/ME Coaxial Contact Data (for environmental requirements)

Components/Accessories

NOTE: The A32W2 & A40W1 (Ring Type Retention); AW8 & A32W4 (LITTLE CAESAR Renention) Coaxial Contact arrangements have been redesigned to provide ease of insertion/removal of the coaxial contacts. Sealing is accomplished with the addition of sealing sleeves provided with the coaxial contact assembly.

RING TYPE RETENTION (A32W2 & A40W1 CONTACT ARRANGEMENTS)

Part Number*		Cable Accommodation		Ins. Dia. Size/Max.	'A' Trim Dim.	Crimp Tool
Without Seal (MA)	Sealed (ME)	Seal 1	Seal 2			
P-249-1397-001	P-249-1397-002	X	RG59B, RG62A	.249 (6.32)	.435 (11.05)	CA58073
S-249-1398-003	S-249-1398-002				.415 (10.54)	
P-249-1399-001	P-249-1399-002	RG58B	X	.200 (5.08)	.460 (11.68)	CA58073
S-249-1400-003	S-249-1400-002				.440 (11.18)	
P-249-1401-001	P-249-1401-002	RG195	RG180B	.158 (4.01)	.460 (11.68)	CA58073
S-249-1402-003	S-249-1402-002				.440 (11.18)	
P-249-1403-001	P-249-1403-002	RG179B	RG174, RG179B,	.113 (2.87)	.460 (11.68)	CCT-406M
S-249-1404-003	S-249-1404-002		RG316		.440 (11.18)	
P-249-1405-001	P-249-1405-002	RG179B, RG196	X	.083 (2.11)	.480 (12.19)	CCT-406M
S-249-1406-003	S-249-1406-002				.460 (11.68)	

*P for pin, S for socket

†Unsealed accommodates both Seal 1 & Seal 2 Cables.

††For use with connectors supplied less grommet (Code 29**, etc.)

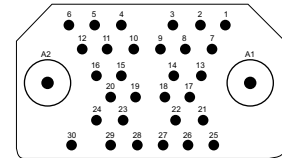

32W2 (MA Version)
A32W2 (ME Version)

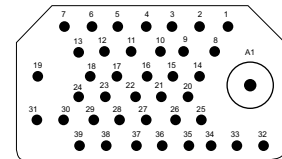

40W1 (MA Version)
A40W1 (ME Version)

Cable Trim Dimensions

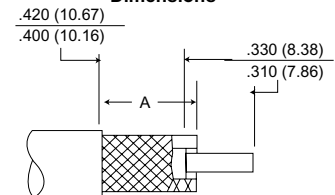

Coaxial Contact Assembly Recommendations

(For Codes A, B, C, D, E, J, K, L and P)

- Center contact, rear insulator, crimp ring, support bushing and seal sleeve are packaged separately and shipped with the coaxial assembly.
- Use impact extraction tool no. CET-C4 (038869-0004). An insertion tool is not required. (See Item 4).
- Cable Assembly Instructions
 - If applicable, determine which portion of seal sleeve should be used. If seal 2 is used, cut off seal 1 portion
 - In sequence, place seal sleeve, support bushing and crimp ring over cable jacket.
 - Trim cable per illustration.
 - Place rear insulator over dielectric.
 - Solder innerconductor to center contact.
 - Insert soldered cable firmly into coaxial with shielding over coaxial shell.
 - Pull crimp ring forward until stopped and crimped.
 - Insert coaxial assembly into connector until engaged. Push support bushing into grommet until shoulder rest on tubular extension. Then pull seal sleeve forward until it is snug against grommet.
- To extract coaxial, push back seal sleeve and support bushing. Then push out coaxial from engaging end with CET-C4 (038869-0004) impact tool.
- When crimping with CA58073 crimp tool, care should be taken to avoid flaring the front end of the crimp ring. Place Crimp jaw so that the second tooth of the indentors is over the end of the crimp ring.
- To facilitate extraction of contacts and avoid splaying the length of free cable adjacent to the rear surface of the connector should not be less than 2.000 (50.80).

WITHOUT SEAL

(For Codes A, B, C, D, E, J, K, L and P)

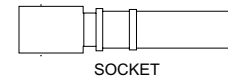

SOCKET

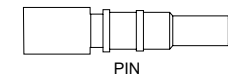

PIN

SEALED

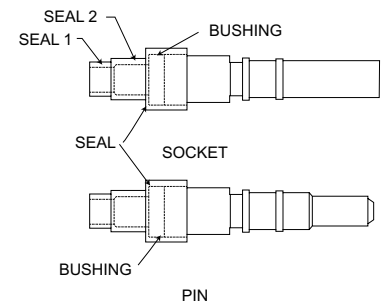

PIN

DPX*MA/ME Coaxial Contact Data (for environmental requirements)

Components/Accessories

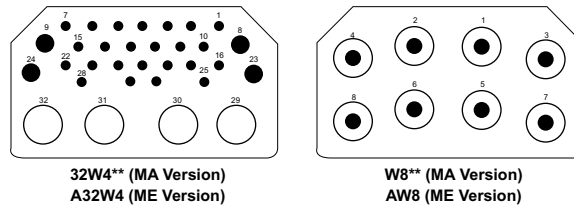

Cable Trim Dimensions

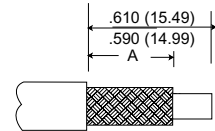

LITTLE CAESAR® CONTACT RETENTION (A32W4 & AW8 CONTACT ARRANGEMENTS)

Part Number*		Cable Accommodation†		Ins. Dia. Size/Max.	'A' Trim Dim.
Without Seal†† (MA)	Sealed (ME)	Seal 1	Seal 2		
P-249-1633-004	P-249-1633-003	RG178	RG174, RG316,	.111 (2.82)	.350 (8.89)
S-249-1634-003	S-249-1634-002		RG179B		
P-249-1982-000	P-249-1982-001	RG180B	RG195	.158 (8.89)	.260 (6.60)
S-249-1983-000	S-249-1983-001				
P-249-2017-001	P-249-2017-000	RG58C	X	.196(4.98)	.260 (6.60)
S-249-2018-001	S-249-2018-000				
P-249-2019-001	P-249-2019-000	RG142B	X	.196 (4.98)	.260 (6.60)
S-249-2020-001	S-249-2020-000				
P-249-2061-001	P-249-2061-000	RG178B	X	.075 (1.90)	.260 (6.60)
S-249-2062-001	S-249-2062-000				

*P for Pin. S for Socket

Unsealed accommodates both Seal 1 & Seal 2 cables.

For use with connector supplied less grommet (Code-29**, etc.).

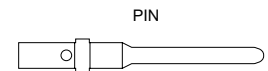
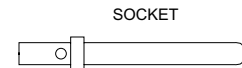

Coaxial Contact Assembly and Extraction Recommendations

- Use Crimp Tool No. DIE Y211 (995-0002-249), Tool M22520 / 5-01 (995-0001-761).
- Use extraction tool No. CET-C8. An insertion tool is not required. (See Note 5).
- Center contact, rear insulator, crimp ring, support bushing (not applicable to RG58/RG142 coaxials), seal sleeve, front insulator, shell and ferrule are shipped unassembled in a common container.
- Cable Assembly Instructions:
 - Step 1 - If applicable, determine which portion of seal sleeve should be used. If seal 2 is used, cut off seal 1 portion.
 - Step 2 - In sequence, place seal sleeve, support bushing and crimp ring over cable jacket.
 - Step 3 - Trim cable per illustration.
 - Step 4 - Comb out braid and flare out ends to permit entry of ferrule.
 - Step 5 - Complete termination per illustration. (See below)
- To extract: coaxial, push back seal sleeve and support bushing. Slip cable into extraction tool. Push tool into insert until it contacts coaxial retaining shoulder. Grip both cable and tool with one hand and pull coaxial rearward out of insert cavity.

WITHOUT SEAL

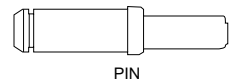
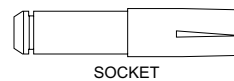

SEALED

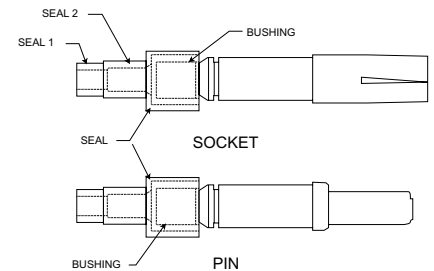

- To facilitate extraction of contacts and avoid splaying, the length of free cable adjacent to the rear surface of the connector should not be less than 2.000 (50.80).

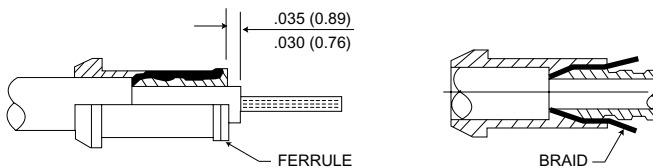

- Carefully push inner conductor through rear insulator.
- While holding rear insulator firmly against ferrule, trim conductor to .156 (3.96)/.146 (3.71) dimension.
- Place contact over conductor and solder.

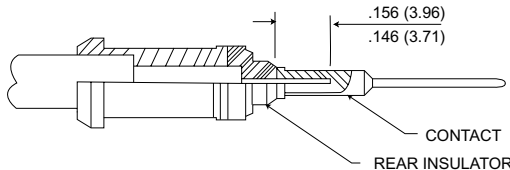

- Push ferrule under braid as far as it will go. Trim off braid extending beyond shoulder of ferrule, if necessary.
- While holding ferrule in place pull crimp sleeve forward over braid until it is tight against shoulder of ferrule. Pull firmly against face of ferrule to make sure it is up tight.
- Trim dielectric to the .035 (0.89)/.030 (0.76) dimension.

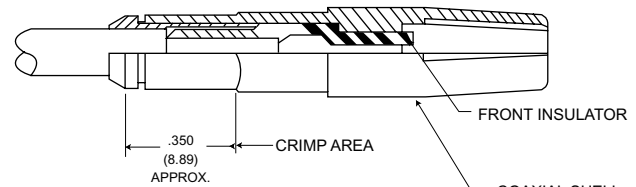

- Place front insulator over contact and then push assembly into coaxial shell.
- Place parts in jaw of crimp tool. Locate jaws at start of chamfer on crimp sleeve. Press sleeve firmly into coaxial shell and crimp.
- After assembled coaxial is inserted into connector, push support bushing into grommet until shoulder rests on tubular extension. Then pull sealing sleeve forward until it is snug on grommet.

Coaxial Cable Assembly Recommendations

LITTLE CAESAR Contact Assembly Data

For Codes F, S and T

1. Strip and trim cable as shown on page 56.
2. Solder inner conductor to coaxial contact with crimp ring over braid and rear insulator over inner conductor.
3. Insert cable into coaxial with shell under braid. Crimp ring with Cannon crimp tool CA58073.

For Codes G, H and R

1. Strip and trim cable as shown on page 56.
2. Solder inner connector to coaxial contact with crimp ring pushed back on cable.
3. Insert cable into coaxial and pull ring forward over braid. Crimp ring with Cannon crimp tool CA58073-0001 or CCT-408M. After crimping, crimp ring must not exceed .252 (6.40) diameter.

For Codes U

1. Strip and trim cable as shown on page 56.
2. Slide crimp ring over braid and jacket of cable.
3. Unbraid exposed portion of braid and fold braid wires backward over outside of crimp ring.
4. Insert prepared wire into right angle fitting of shell assembly. Conductor should be aligned in slot of the center contact. Crimp with Cannon tool CCT/C10.
5. Solder center conductor of cable to contact. Insert cap and solder in place.

For Codes AA

1. Slip ferrule over cable jacket. Trim outer jacket. Comb out braid as shown. Retrim braid.
2. Bend up combed out braid at right angles to cable. Slide ferrule up to bend and fold braid back against ferrule.
3. Slide rear insulator over dielectric as shown. Press insulator firmly against folded back braid and trim dielectric flush with insulator. Then cut inner conductor to length shown.
4. Place contact over conductor. Press contact and insulator firmly against braid and solder contact to conductor.
5. Push cable assembly into shell, pressing against rear of ferrule and crimp area shown with T. & B. #WT-400 Crimp Tool while making sure parts do not move out of place.

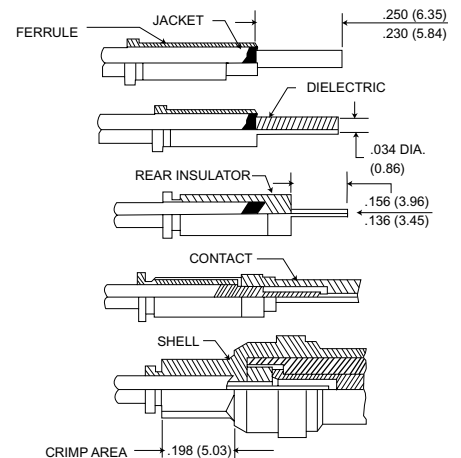

For Codes AC

1. Trim jacket to .680 (17.27)/.660 (16.76) dimension. Then slide ferrule over braid until it stops against jacket, and comb out exposed portion of braid.
2. Fold combed braid over ferrule as shown. Then trim dielectric to .070 (1.78)/.060 (1.52) dimension and slide rear insulator over dielectric until it presses against braid.
3. Press insulator against braid and trim inner conductor to .247 (6.27)/.237 (6.02) dimension. Then place contact over conductor and crimp with MS3191-3 (do not use MS3191-1). Press parts firmly against locator during crimping operation.
4. Place front insulator over contact. Push parts into coaxial shell. While holding parts firmly against stop shoulder in coaxial shell, place jaw of crimp tool at back end of shell and crimp. Use Buchanan crimp tool #612991 (.343 [8.71] across hex).

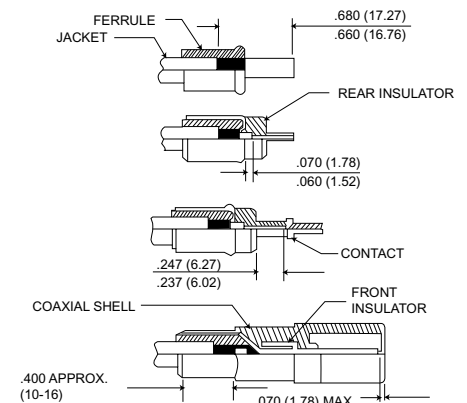

Coaxial Cable Assembly Recommendations (Continued)

For Code V

1. Trim cable to dimensions shown below.
 - A. Push ferrule under braid as far as it will go and press braid down tightly around ferrule.
 - B. Solder ends of braid to ferrule by applying a small amount of solder. Avoid excess solder as it would cause braid to swell up.
 - C. Remove any solder exceeding the .349 (8.86) max. diameter.
 - D. Check the .075 (1.90) max. dielectric extension, retrim if necessary.
3. A. Place rear insulator over dielectric and conductor into contact.
 - B. Solder contact to conductor through access hole.
 - C. Remove excess solder from outside of contact.
4. A. Place front insulator over contact.
 - B. Push parts into coaxial shell.
 - C. While holding parts firmly against stop shoulder in coaxial shell, place jaw of crimp tool at back end of shell and crimp, use Buchanan crimp tool #612991 [.343 (8.71) across hex].

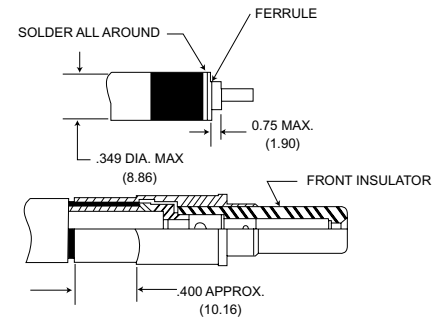

For Codes AB, AD, AE, AF and AG

Setp 1 - Trim cable as shown.

Step 2 - Flare out ends of braid to permit entry of ferrule.

Step 3 - Complete termination per instructions as shown below.

- a. Push ferrule under braid as far as it will go. Trim off braid extending beyond shoulder of ferrul, if necessary.
- b. While holding ferrule in place pull crimp sleeve forward over braid until it is tight against shoulder on ferrule. Push firmly against face of ferrule to make sure it is up tight.
- c. Trim dielectric to the .035 (0.89)/.030 (0.76) dimension.
- d. Carefully push inner conductor through rear insulator.
- e. While holding rear insulator firmly against ferrule, trim conductor to .156 (3.96)/.146 (3.71) dimension.
- f. Place contact over conductor and solder.
- g. Place front insulator over contact and then push assembly into coaxial shell.
- h. Place parts in jaw of crimp tool. Locate jaws at start of chamfer on crimp sleeve. Press Sleeve firmly into coaxial shell and crimp. Use Daniels crimp tool HX4-210.

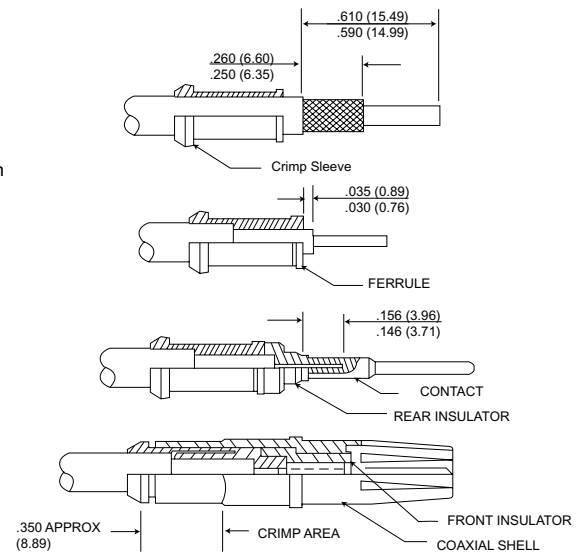

Cable Trim Dimensions

Code Letter	Inches			Millimeters		
	A	B	C	A	B	C
A	.420/.400	.432/.415	.330/.310	10.67/10.16	11.05/10.54	8.38/7.87
B, C, D & P	.420/.400	.460/.440	.330/.310	10.67/10.16	11.68/11.18	8.38/7.87
E	.420/.400	.480/.460	.330/.310	10.67/10.16	12.19/11.68	8.38/7.87
F	.785/.745	.275/.255	.228/.208	19.94/18.92	6.98/6.48	5.79/5.28
G	.490/.470	.275/.255	.156/.136	12.45/11.94	6.98/6.48	3.96/3.45
H & R	.581/.561	.345/.325	.156/.136	14.76/14.25	8.76/8.26	3.96/3.45
J	.326/.306	.250/.230	.088/.068	8.28/7.77	6.35/5.84	2.24/1.73
K	.410/.390	.290/.270	.088/.068	10.41/9.91	7.37/6.86	2.24/1.73
L	.385/.365	.244/.224	.074/.064	9.78/9.27	6.20/5.69	1.88/1.63
S	.678/.658	.275/.255	.156/.136	17.22/16.71	6.98/6.48	3.96/3.45
U	.940/.920	.760/.740	.080/.060	23.88/23.37	19.30/18.80	2.03/1.52
V	.550/.540	.415/.405	.250/.240	13.97/13.72	10.54/10.29	6.35/6.10
T	.598/.578	.300/.280	.228/.208	15.19/14.68	7.62/7.11	5.79/5.28
AA, AC	See page 62 for dimensions					
AB, AD, AE, AF, AG	See page 63 for dimensions					

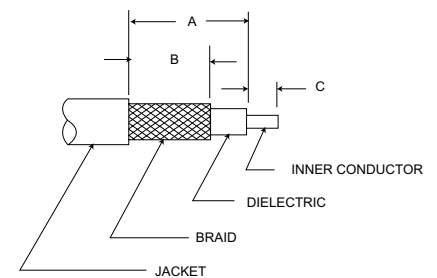

Modifications Codes

DPXA Modifications Codes

- 4. Mounting holes .120 (3.05) dia. c'sink 100° to .225 (5.72) dia.
- 5. 4-40 clinch nuts.
- 6. Removable insert retainer plate.
- 7. Mounting holes .120 (3.05) dia. c'sink 82° to .230 (5.84) dia.
- 12. Mounting holes .132 (3.35)/.125 (3.18).
- 16. A106 insert with separator.
- 17. With grommet and mounting holes .120 (3.05) dia. countersunk 100° to .225 (5.72) dia.
- 70. Standard mounting with (LIF) contacts.
- 77. Same as -7 except with low insertion force (LIF) contacts (for LIF contact data).

DPXB and DPX2/3/4 Modification Codes

Some of the modification numbers used in the DPX lines apply to all types and some are applicable for only certain types. The following chart gives the modification number, the description, and the shell type in which they may be used (-33 is for plug shells, -34 is for receptacle shells).

	Modification	Applicable Series	Definition
DESCRIBES STANDARD CONNECTOR HOUSING	- 00**	DPX2-33 and 34 DPX2-33A DPX2-33F and 34F DPX2-33M and 34M	Standard construction, mounting holes .120 (3.05) dia. and with tabs for junction shells.
	- 00	DPX2-34A	Standard construction - six floating eyelets and tabs for junction shells,
	- 00	DPX2-33B DPXB-33 DPX3-33 DPX4-33	Standard construction, mounting holes .120 (3.05) dia. countersunk 82° to .230 (5.84) dia. - no tabs.
	- 00	DPX2-34B DPXB-34 DPX3-34 DPX4-34	Standard construction, mounting holes 120 (3.05) dia. - no tabs.
MODIFICATION 01	- 01	DPX2-33 and 34 DPX2-33A DPX2-34A DPX2-33F and 34F DPX2-33M-34M	Standard construction and with standard junction shells.
	- 01	DPX2-34B/33B DPXB-34	With four #4-40 clinch nuts in mounting holes.
	- 01	DPX3-34	With six #4-40 clinch nuts in mounting holes.
	- 01	DPX4-34	With ten #440 clinch nuts in mounting holes.
MODIFICATION 02 ATTACHING TABS	- 02	DPX2-33 and 34 DPX2-33A DPX2-34A DPX2-33F and 34F DPX2-33M and 34M	Standard construction and with 90° junction shells.
	- 02	DPX2-33B and 34B DPXB-33 and 34 DPX3-33 and 34 DPX4-33 and 34	Standard construction and with tabs for attaching junction shells.
	- 02	DPXBME-33 and 34 DPX2ME-33 and 34 DPX3ME-33 and 34 DPX4ME-33 and 34	Standard construction and with tabs for attaching junction shells.
	- 03	DPX2-33 and 34 DPX2-33A DPX2-33F and 34F DPX2-33M and 34M DPXB-33 and 34 DPX3-33 and 34 DPX4-33 and 34	Mounting holes .120 (3.05) dia. countersunk 100° to .230(5.84) dia.

⚠ Applicable for all MA, ME, NA & NE Series Connectors.
 ⚠ Applicable to NE Series also.

Modification Codes

	Modification	Applicable Series	Definition
<p>MODIFICATION 04</p>	- 04**	DPX2-33B DPXB-33 DPX3-33 DPX4-33	.120 (3.05) dia. mounting notes countersunk 100° to .230 (5.84) dia. and tabs for attaching junction shells.
<p>ALTERNATE STYLE</p>			
<p>MODIFICATION 08</p>	- 08	DPX2-33 and 34 DPX2-33F and 34F	Mounting holes .137 (3.48) dia. countersunk 82° to .230 (5.84) dia.
<p>MODIFICATION 12</p>	- 12	DPX2-34B DPXB-34	With mounting slots .208 (5.28) wide.
<p>MODIFICATION 13</p>	- 13	DPX2-34B DPXB-34	With mounting slots .237 (6.02) wide.
<p>(SEE PAGE 58 FOR JUNCTION SHELL CONFIGURATIONS)</p>	- 14	DPX2-33B DPXB-33 DPX2-34B DPXB-34 DPX3-33 DPX3-34	With straight junction shelf. (Not available on DPX4)
<p>MODIFICATION 17</p>	- 17	DPX2-33B DPXB-33 DPX2-34B DPXB-34	With four #4-40 clinch nuts in mounting holes and tabs for attaching junction shells.
<p>ALTERNATE STYLE</p>			
	- 17	DPX3-34	With six #4-40 clinch nuts in mounting holes and tabs for attaching junction shells.
	- 17	DPX4-34	With ten #4-40 clinch nuts in mounting holes and tabs for attaching junction shells,
<p>MODIFICATION 18</p>	- 18	DPX2-33B DPXB-33 DPX2-34B DPXB-34 DPX3-34	With six #4-40 clinch nuts in mounting holes and tabs for attaching junction shells.
<p>ALTERNATE STYLE</p>			

Applicable for all MA, ME, NA & NE Series Connectors.

Modification Codes

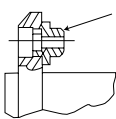
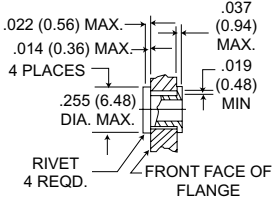
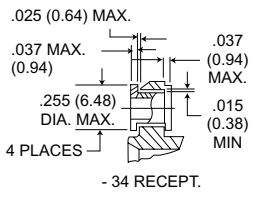
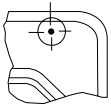
	Modification	Applicable Series	Definition
 <p>#4-40 CLINCH NUTS</p> <p>MODIFICATION 19</p>	- 19**	DPX2-33B DPXB-33 DPX2-34B DPXB-34 DPX3-33 DPX3-34 (Same as Code -01)	With six #4-40 clinch nuts in mounting holes. Do not assign - use -01 code
<p>MODIFICATION 20</p>	- 20	DPX2-33A DPX2-34A	Standard construction without tabs on insert retaining plate.
<p>SUPERSEDED BY 01 MOD.</p> <p>MODIFICATION 22</p>	- 22	DPX2-33 and 34 DPX2-33A DPX2-33B DPXB-33 DPX2-33M and 34M DPX3-33 DPXBME, DPX2ME, DPX3ME, DPX4ME - 33 only DPX2-33F and 34F	With eight #4-40 clinch nuts in mounting holes. Same as 01. 01 Recommended
 <p>.022 (0.56) MAX. .014 (0.36) MAX. 4 PLACES .255 (6.48) DIA. MAX. RIVET 4 REQD. FRONT FACE OF FLANGE - 33 PLUG</p> <p>.025 (0.64) MAX. .037 MAX. .019 (0.48) MIN. .037 MAX. (0.94) .015 (0.38) MIN. 4 PLACES - 34 RECEPT.</p> <p>MODIFICATION 23</p>	- 23	DPX2-33 and 34 DPX2-33A DPX2-33B DPXB-33 DPX2-34B DPXB-34 DPX3-33 and 34 DPX4-33 and 34 DPX2-33F and 34F	With floating eyelets.
 <p>MOUNTING HOLES(4), .156(3.96) DIA.</p> <p>MODIFICATION 25</p>	- 24 - 25	DPX2-34A DPX2-33B DPX2-34B DPXB-34	With six mounting holes .208 (5.28) dia. (Floating eyelets omitted) With four mounting holes .157 (3.99)/.155 (3.94) dia. (Clinch nuts omitted)
 <p>MOUNTING HOLES(4), .120 (3.05) DIA., C'SUNK 82° TO .230 (5.84) DIA.</p> <p>MODIFICATION 26</p>	- 26	DPX2-34B DPXB-34 DPX3-34	Mounting holes .120 (3.05) dia. countersunk 82° to .230 (5.84) dia. and has tabs for attaching junction shells.
	- 29	DPX2-34A	With interfacial seal (if pins) without junction shell tabs and military gold plating on the contact.
	- 29	DPXBME-34P & 33S DPX2ME-34P & 33S DPX3ME-34P & 33S DPX4ME-34P & 33S	Standard except less grommet* * On the A106S layout the grommet is replaced by the separator.
	- 30	DPXBME-34P DPX2ME-34P DPX3ME-34P DPX4ME-34P	Standard except less grommet and with tabs for attaching junction shells. (-34 pin only)
	- 31	DPXBME-34P DPX2ME-34P DPX3ME-34P DPX4ME-34P	Standard except less grommet and with floating bushings. (Slatted shells).
	- 33	DPXBME-34P DPX2ME-34P DPX3ME-34P DPX4ME-34P	Standard except less grommet and with clinch nuts in mounting holes.
	- 37	DPXBME-34P DPX2ME-34P DPX3ME-34P DPX4ME-34P	Standard less grommet and with clinch nuts in mounting holes and with tabs for attaching junction shells.

 Applicable for all MA, ME, NA and NE Series Connectors.



**Indicates polarizing position. (See page 68)

Modification Codes

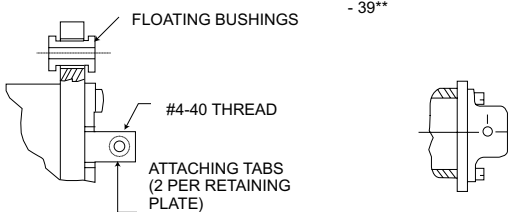
Modification	Applicable Series	Definition
 <p>MODIFICATION 39</p>	<p>ALTERNATE STYLE</p> <p>DPXB-33 & 34 DPX2-33B DPX2-34B DPX3-33 & 34 DPX4-33 & 34</p>	<p>With floating eyelets & tabs for attaching junction shells.</p>
- 39**		
- 70**	All DPX series with LITTLE CAESAR retention	Same as -00 with addition of LIF contacts See Contact Section Page 54
- 71	All DPX series with LITTLE CAESAR retention	Same as -31 with addition of LIF contacts See Contact Section Page 54
- 72	All DPX series with LITTLE CAESAR retention	Same as -01 with addition of LIF contacts See Contact Section Page 54
- 73	All DPX series with LITTLE CAESAR retention	Same as -23 with addition of LIF contacts See Contact Section Page 54
- 74	All DPX series with LITTLE CAESAR retention	Same as -33 with addition of LIF contacts See Contact Section Page 54
- 75	All DPX series with LITTLE CAESAR retention	Same as -02 with addition of LIF contacts See Contact Section Page 54
- 76	All DPX as listed for code -22	Same as -22 with addition of LIF contacts
- 77	All DPXB series	Mounting holes .120 (3.05) dia. countersunk 82° to .230 (5.84) dia. and has LIF contacts.
- 78		
- 79	All DPX series with LITTLE CAESAR retention	Same as -29 with addition of LIF contacts

△ Applicable for all MA, ME, NA and NE Series Connectors.

△ Applicable for NE Series Also.

**Indicates polarizing position. (See page 68)

Polarization

Two Post Type

DPX2-33F or 33M

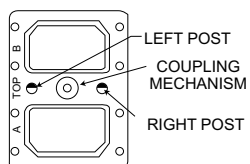

DPX2-34F or 34M

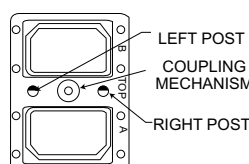

Face View of Engaging End

Three Post Type

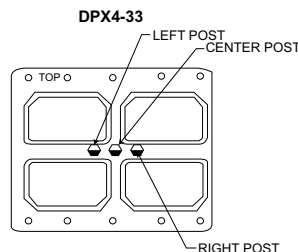
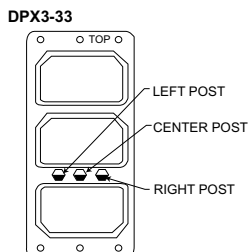
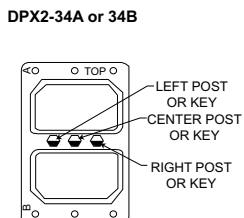
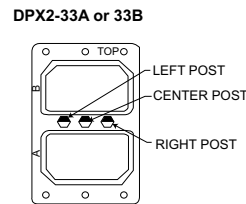
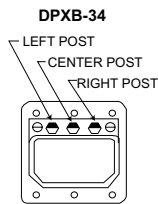
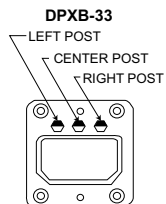

Polarization

Positions

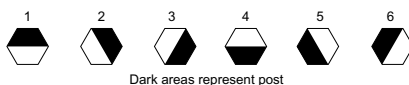

Two Post Type

33 PLUG MALE SHELL						34 RECEPTACLE FEMALE SHELL					
Position	Left Post	Right Post	Position	Left Post	Right Post	Position	Left Post	Right Post	Position	Left Post	Right Post
01	4	4	09	3	3	01	1	1	09	2	2
02	5	4	10	4	2	02	1	6	10	3	1
03	6	4	11	2	2	03	1	5	11	3	3
04	2	4	12	3	2	04	1	3	12	3	2
05	3	4	13	2	1	05	1	2	13	4	3
06	4	3	14	3	1	06	2	1	14	4	2
07	5	3	15	2	6	07	2	6	15	5	3
08	2	3				08	2	3			

Three Post Type

PLUG SHELL				RECEPTACLE SHELL											
Position	Left Post	Center Post	Right Post	Position	Left Post	Center Post	Right Post	Position	Left Post	Center Post	Right Post	Position	Left Post	Center Post	Right Post
01	1	1	1	51	3	2	5	01	4	4	4	51	6	3	2
02	2	1	1	52	4	2	4	02	4	4	3	52	6	3	1
03	3	1	1	53	5	2	5	03	4	4	2	53	6	3	6
04	4	1	1	54	6	2	5	04	4	4	1	54	6	3	5
05	5	1	1	55	1	2	4	05	4	4	6	55	1	3	4
06	6	1	1	56	2	2	4	06	4	4	5	56	1	3	3
07	1	1	6	57	3	2	4	07	5	4	4	57	1	3	2
08	2	1	6	58	4	2	4	08	5	4	3	58	1	3	1
09	3	1	6	59	5	2	4	09	5	4	2	59	1	3	6
10	4	1	6	60	6	2	4	10	5	4	1	60	1	3	5
11	5	1	6	61	1	2	3	11	5	4	6	61	2	3	4
12	6	1	6	62	2	2	3	12	5	4	5	62	2	3	3
13	1	1	5	63	3	2	3	13	6	4	4	63	2	3	2
14	2	1	5	64	4	2	3	14	6	4	3	64	2	3	1
15	3	1	5	65	5	2	3	15	6	4	2	65	2	3	6
16	4	1	5	66	6	2	3	16	6	4	1	66	2	3	5
17	5	1	5	67	1	2	2	17	6	4	6	67	3	3	4
18	6	1	5	68	2	2	2	18	6	4	5	68	3	3	3
19	1	1	4	69	3	2	2	19	1	4	4	69	3	3	2
20	2	1	4	70	4	2	2	20	1	4	3	70	3	3	1
21	3	1	4	71	5	2	2	21	1	4	2	71	3	3	6
22	4	1	4	72	6	2	2	22	1	4	1	72	3	3	5
23	5	1	4	73	1	3	1	23	1	4	6	73	4	2	4
24	6	1	4	74	2	3	1	24	1	4	5	74	4	2	3
25	1	1	3	75	3	3	1	25	2	4	4	75	4	2	2
26	2	1	3	76	4	3	1	26	2	4	3	76	4	2	1
27	3	1	3	77	5	3	1	27	2	4	2	77	4	2	6
28	4	1	3	78	6	3	1	28	2	4	1	78	4	2	5
29	5	1	3	79	1	3	6	29	2	4	6	79	5	2	4
30	6	1	3	80	2	3	6	30	2	4	5	80	5	2	3
31	1	1	2	81	3	3	6	31	3	4	4	81	5	2	2
32	2	1	2	82	4	3	6	32	3	4	3	82	5	2	1
33	3	1	2	83	5	3	6	33	3	4	2	83	5	2	6
34	4	1	2	84	6	3	6	34	3	4	1	84	5	2	5
35	5	1	2	85	1	3	5	35	3	4	6	85	6	2	4
36	6	1	2	86	2	3	5	36	3	4	5	86	6	2	3
37	1	2	1	87	3	3	5	37	4	3	4	87	6	2	2
38	2	2	1	88	4	3	5	38	4	3	3	88	6	2	1
39	3	2	1	89	5	3	5	39	4	3	2	89	6	2	6
40	4	2	1	90	6	3	5	40	4	3	1	90	6	2	5
41	5	2	1	91	1	3	4	41	4	3	6	91	1	2	4
42	6	2	1	92	2	3	4	42	4	3	5	92	1	2	3
43	1	2	6	93	3	3	4	43	5	3	4	93	1	2	2
44	2	2	6	94	4	3	4	44	5	3	3	94	1	2	1
45	3	2	6	95	5	3	4	45	5	3	2	95	1	2	6
46	4	2	6	96	6	3	4	46	5	3	1	96	1	2	5
47	5	2	6	97	1	3	3	47	5	3	6	97	2	2	4
48	6	2	6	98	2	3	3	48	5	3	5	98	2	2	3
49	1	2	5	99	3	3	3	49	6	3	4	99	2	2	2
50	2	2	5					50	6	3	3				

The last two digits in the DPX nomenclature (ex: DPXB-8-33B-0014) refer to the polarizing post position. When the last two digits are omitted it means the polarizing posts will not be assembled and position number is not stamped on the connector. This allows the customer to position the posts themselves and then stamp the appropriate number on the shell. If the last two digits are made 00 it means the polarizing posts are deleted.

All tolerances are ± .015 (0.38) unless otherwise noted.

Recommended Flange Spacing

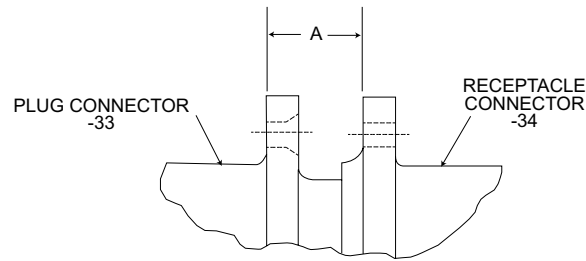

Type Connector	Dim. A (mm)	Comments
DPXA	.622 (15.80) .549 (13.94)	For both solder & crimp type contacts
DPXB	.365 (9.27) .292 (7.42)	For both solder & crimp type contacts ARINC B Shell
DPX2- B	.365 (9.27) .292 (7.42)	ARINC A Shell for both solder & crimp type contacts
DPX2	.633 (16.08) .560 (14.22)	
DPX2- A	.633 (16.08) .560 (14.22)	ARINC A Shell for both solder & crimp type contacts
DPX3	.365 (9.27) .292 (7.42)	For both solder & crimp type contacts
DPX4	.365 (9.27) .292 (7.42)	For both solder & crimp type contacts

⚠ Flange spacing required for NE/NA by MIL-C-81659 [.297/.281 (7.54/7.14)]

⚠ For environmental ME with interfacial seal recommend flange spacing of [.321/.281 (8.15/7.14)]

Panel Cutouts

DPXA

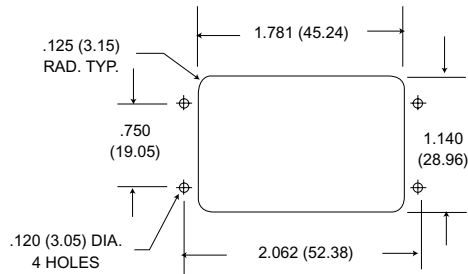

NOTE - WHEN USING THE -2301 FLOATING EYELET MODIFICATION, ADD .050 (1.27) TO THE CUTOUT SIZE TO ALLOW FOR FLOAT (EXCEPTION -34A)

DPXB

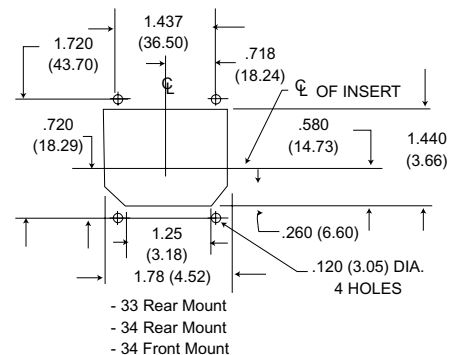
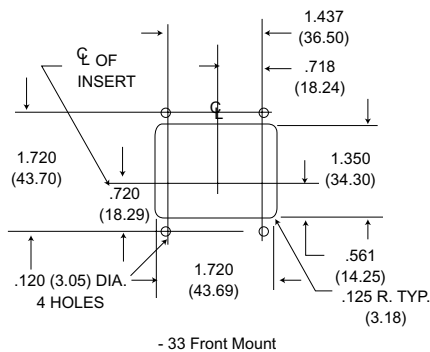

Panel Cutouts

DPX2

All tolerances are ± .015 (0.38) unless otherwise noted.

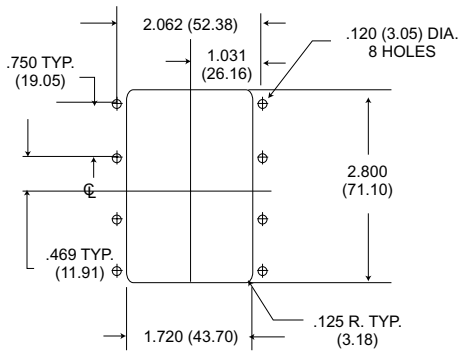

- 33 FRONT MOUNT

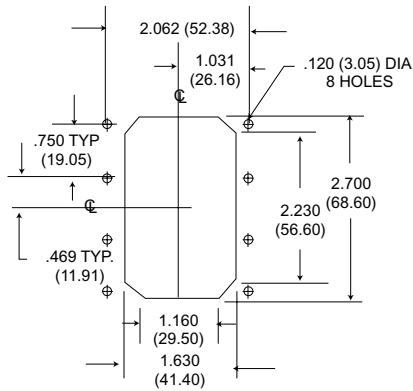

- 33 REAR MOUNT

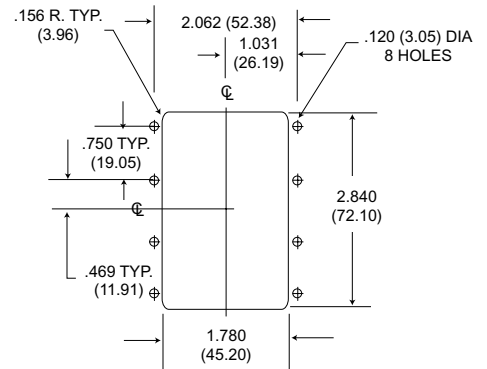

- 34 FRONT OR REAR MOUNT

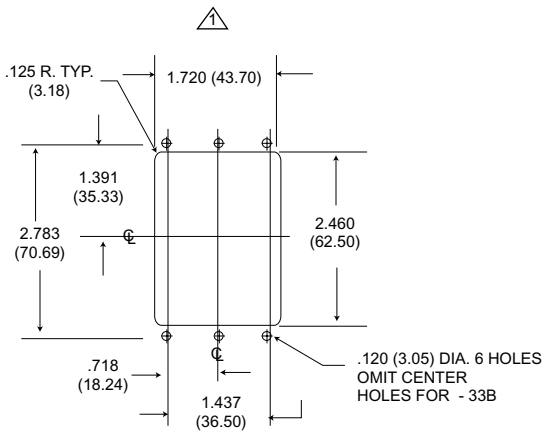

- 33A & -33B FRONT MOUNT

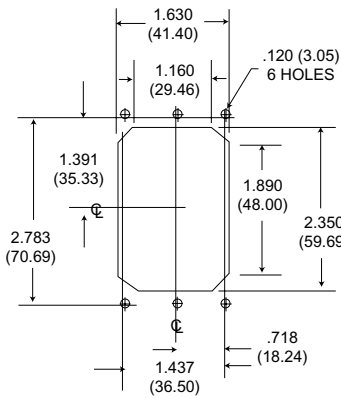

- 33A REAR MOUNT

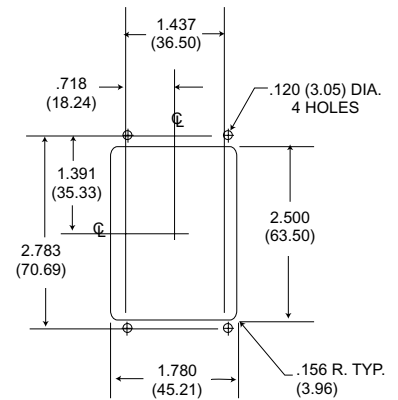

- 34B FRONT MOUNT

For - 23 float mtg. mod. 1.78 (45.21).

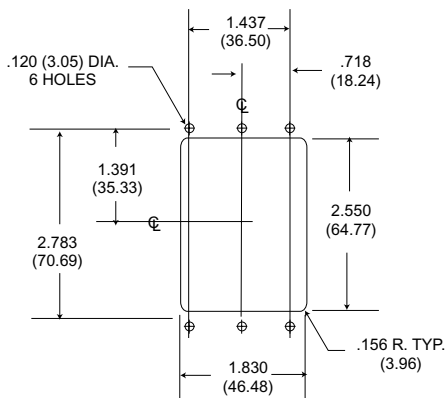

- 34A REAR MOUNT (-34A FRONT MOUNT CONSULT FACTORY)

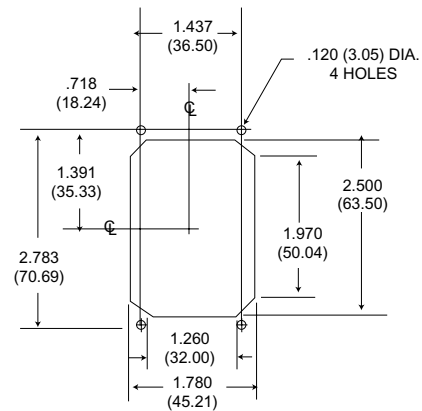

- 33B REAR MOUNT - 33B REAR MOUNT

Panel Cutouts

DPX3

All tolerances are ± .015 (0.38) unless otherwise noted.

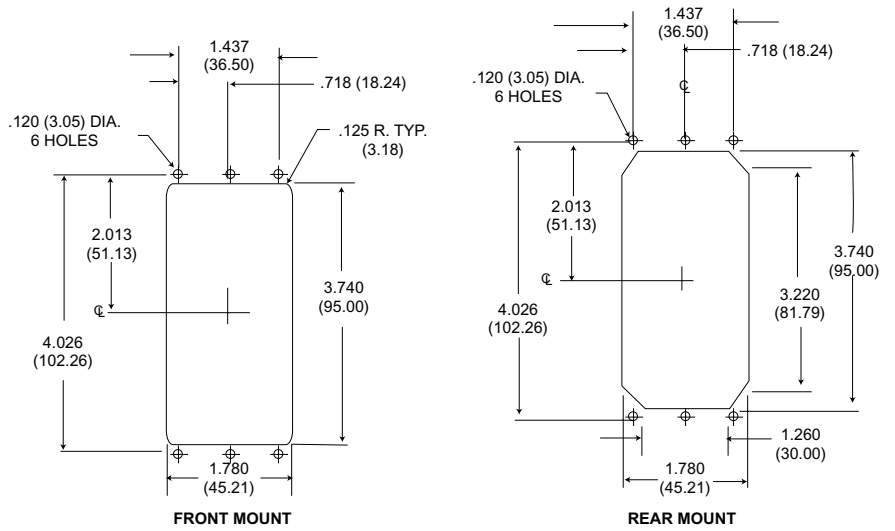

DPX4

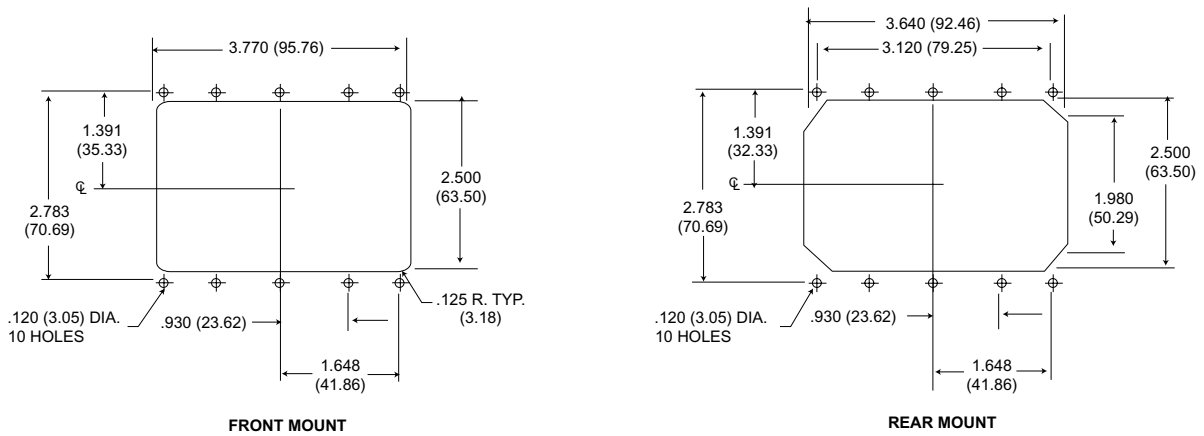

Sealing Plugs - DPX*ME (for environmental requirements)

Material: Teflon
(All others thermoplastic)

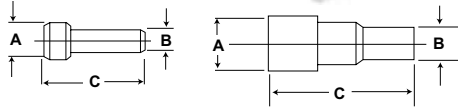

Part Number	Contact Size	Color	A	B	C
225-1013-000	22	Black	.063 (1.6)	.040 (1.0)	.469 (11.9)
225-0070-000	20	Red	.085 (2.2)	.065 (1.6)	.469 (11.9)
225-0071-000	16	Blue	.115 (2.9)	.075 (1.9)	.469 (11.9)
225-0072-000	12	Yellow	.171 (4.3)	.121 (3.1)	.564 (14.3)
225-0090-000	#5 and #9 Coax	White	.365 (9.3)	.287 (7.3)	.835 (21.2)

Filler Plugs - DPX*

Material: Teflon
(All others thermoplastic)

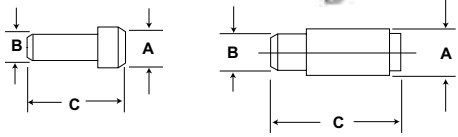

Part Number	Contact Size	Color	A	B	C
225-0094-000	22	Black	.069 (1.7)	.051 (1.3)	.420 (10.7)
225-0095-000	20	Red	.083 (2.1)	.069 (1.7)	.350 (8.9)
225-0096-000	16	Blue	.131 (3.3)	.108 (2.7)	.320 (8.1)
225-0097-000	12	Yellow	.187 (4.7)	.156 (4.0)	.320 (8.1)
225-0098-000	#5 Coax (Pin)	White	.275 (7.0)	.251 (6.4)	.450 (11.4)
225-0099-000	#5 and #9 Coax (Socket)	White	.275 (7.0)	.251 (6.4)	1.061 (26.9)

Junction Shells

90° Angle

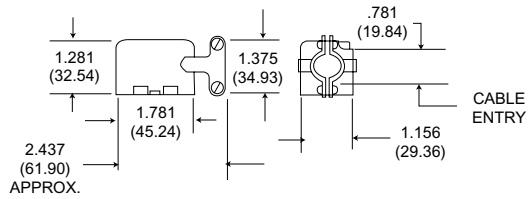

Style	Part Number
(Right) DPXA	20745-22
(Left) DPXA	20745-23
(Right) DPX2	20745-10
(Left) DPX2	20745-11

**(DPXA ONLY)
DIECAST STRAIGHT JUNCTION SHELL**

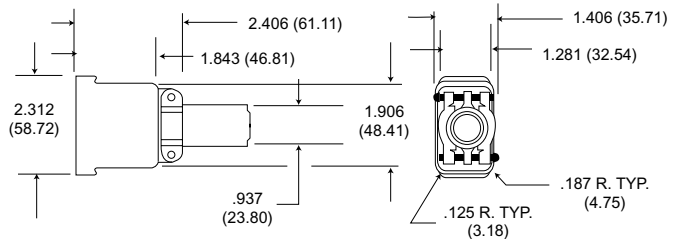

Style	Part Number
DPXA	22017

**90° ANGLE DPX2
JUNCTION SHELL (SIDE OUTLET)**

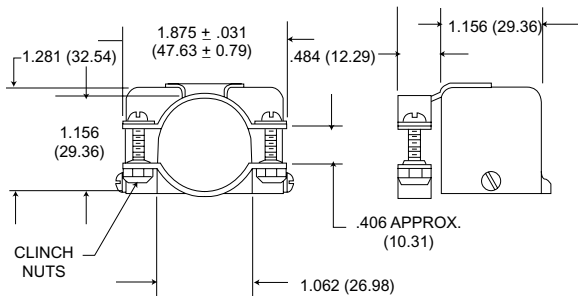

Style	Part Number
DPX2	20745-12

**(DPXA ONLY)
DIECAST STRAIGHT JUNCTION SHELL**

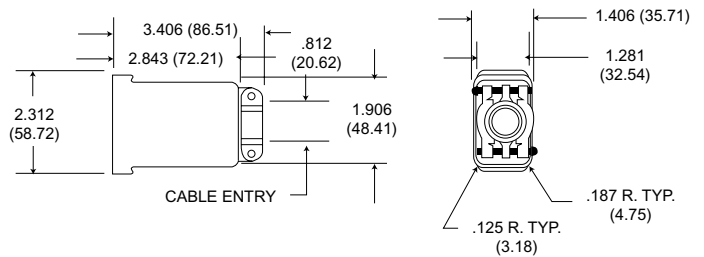

Style	Part Number
DPXA	22017-2

STRAIGHT JUNCTION SHELL

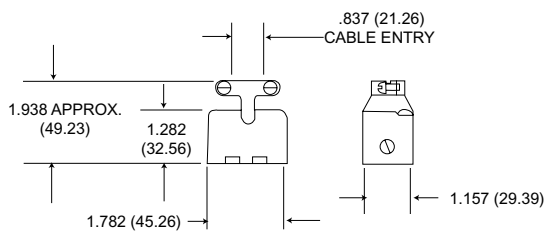

Style	Part Number
DPXA	20745-21
DPX2	20745-8

**(DPXA ONLY)
DIECAST 90° ANGLE JUNCTION SHELL**

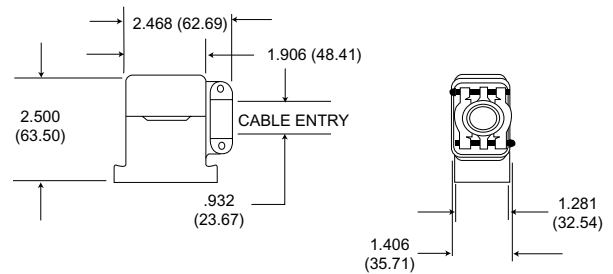

Style	Part Number
DPXA	22017-1

* DPX2 Junction Shells are also used on DPXB connectors.

Diecast junction shells may be used on DPXA connectors. They have 4-40 NC-2B tapped mounting holes for attaching to the shell mounting hardware.

Dust Caps



34

DPXA-60 for 34 Shells
025-0762-000
DPXB-60 for 34 Shells
025-0767-000

Conductive

DPXB-60-1 for 34 Shell
Conductive Dust Caps
025-0767-001
Protect Against
Static Electricity



33

DPXA-59 for 33 Shells
025-0749-000
also used DPXB-33

Conductive

DPXA-59 for 33 Shells
025-0749-001

Coaxial Cable Reference Guide

For BKA* DPX Series (Crimp, & Solder)
 Reference MIL-C-17D & DPX NE/NA MIL-C-81659 Series

RG/U Type	Inner Conductor	Dielectric Material	DOD (Inch)	Jacket Material	O.D (Inch)	Weight (lbs/ft)	Max Oper. Temp, Range (C)	Max Oper. Voltage (Volts RMS)	Suggested Alt Cable	Code Crimp Type Coax	Code Solder Type Coax	DPX NE/NA Military	BKA* ARINC Type Coax
7	0.0359 "	Air-space PE	0.250	PVC	0.370	0.080	-40 + 80	1,000	Use RG63B	—	I	—	—
9	0.0855"	PE	0.280	PVC	0.420	0.140	-40 + 80	4,000	Use RG214	—	R,AC	—	Size 1(71W1)
55	0.0320 "	PE	0.116	PE	0.206 Max.	0.032	-55 + 80	1,900	Use RG55B	S	C, J	—	Size 1(71W1)
58	0.0320"BC	PE	0.116	PVC	0.195	0.029	-40 + 80	1,900	Use RG58B	D,P,G JAC,AD	C, J, Z AB	Size 5/9 Seal 1	Size 1(71W1) Size 5
59	0.0253 "	PE	0.146	PVC	0.242	0.032	-40 + 80	2,300	Use RG59B	A,F,T	D	—	—
59B	0.0230"	PE	0.146	PVC	0.242	0.032	-40 + 80	2,300	Use up to 1000 MHz	—	—	—	—
62	0.0253"	Air-space PE	0.146	PVC	0.242	0.038	-40 + 80	750	Use RG62A	A,F,T	E	—	—
62A	0.0253"	Air-space PE	0.146	PVC	0.242	0.038	-40 + 80	750	—	—	—	—	—
71	0.0253"	Air-space PE	0.146	PVC	0.250 Max.	0.046	-40 + 80	750	Use RG71B	—	E	—	—
115	0.0840"	PTFE	0.250	FG Braid	0.375	0.148	-55 + 250	5,000	Use RG115A	V	—	—	Size 1(71W1)
142	0.0359"	PTFE	0.116	FG Braid	0.206 Max.	0.047	-55 + 250	1,900	Use RG142A	S,AE	—	Size 5/9 Seal 1	Size 1(71W1) Size 1(71W1A)
142B	0.0390"	PTFE	0.116	FEP	0.195	0.050	-55 + 200	1,900	—	—	—	—	Size 1(71W1A) Size 5
174	0.0189"	PE	0.060	PVC	0.100	0.008	-40 + 80	1,500	—	D,H,U, AF	—	Size 5/9 Seal 2	Size 5 Size 12
178	0.0120"	PTFE	0.036	KEL-F	0.079 Max.	0.0054	-40 + 150	1,000	Use RG178B	ER,K,AG, L,M,AF	—	Size 5/9 Seal 1	Size 5
179	0.0120 "	PTFE	0,057	KEL-F	0.094 Max.	0.010	-55 + 150	1,200	Use RG179B	D,H,U, AF	—	Size 5/9 Seal 1 Seal 2	Size 5
179B	0.0120"	PTFE	0.063	FEP	0.100	0.010	-55 + 200	1,200	—	—	—	—	Size 5
180	0.0120"	PTFE	0.103	KEL-F	0.141 Max. 0.145 Max.	0.019	-40 + 150	1,500	Use RG180B	CAB	B	Size 5/9 Seal 1	Size 5
180B	0.0120"	PTFE	0.102	FEP	0.145 Max.	0.019	-55 + 200	1,500	—	AB	—	—	Size 5
187	0.0120"	PTFE	0.060	PTFE	0.110 Max.	0.010	-55 + 250	1,200	Use RG179B	D,H,U, AF	A,K	—	Size 5
188	0.0201"	PTFE	0.060	PTFE	0.110 Max.	0.011	-55 + 250	1,200	Use RG316	D,A,U AF	A,K	—	—
195	0.0120"	PTFE	0.102	PTFE	0.155 Max.	0.020	-55 + 250	1,500	Use RG180B	CAB	B	—	Size 5
196	0.0120'	PTFE	0.034	PTFE	0.080 Max.	0.006	-55 + 250	1,000	Use RG178B	E,R,K, L,AA,AG	AA	Size 5/9 Seal 1	Size 5
214	0.0888"	PE	0.285	PVC	0.425	0.126	-40 + 80	5,000	—	—	R,AC	—	Size 1(71W1) Size 1(71W1A)
223	0.035 "	pE	0.116	PVC	0.216 Max.	0.034	-40 + 80	1,900	—	—	C,J	—	—
225	0.0936"	PTFE	0.285	FG Braid	0.430	0.180	-55 + 250	5,000	—	—	—	Size 5/9 Seal 2	Size 1(71W1)
316	0.0201	PTFE	0.060	FEP	0.102	0.012	-55 + 200	1,200	Use RG188A	—	—	Size 5/9 Seal 2	—
393	0.0936"	PTFE	0.285	FEP	0.390	0.165	-55 + 200	5,000	Use RG225	—	—	—	Size 1(71W1A)
400	0.0385"	PTFE	0.116	FEP	0.195	0,050	-55 + 200	1,900	—	—	—	—	Size 1(71W1)
402	0.0360"	PTFE	0.119	None	0.141	0.032	-55 + 200	2,500	Use RG142B	—	—	—	Size 1(71W1) Size 1(71W1A)

NOTE: This table is shown for reference only. ITT Cannon recommends that the above information be used as a guideline and may be subject to variation between various cable manufacturers. For specific information concerning the actual physical characteristics of a specific cable, contact the manufacturer.

HIGH-PERFORMANCE MIL-C-83733 QUALIFIED Temperature Ranges of - 65 C to +200 C Environment - Resistant

The Cannon DPK series are high performance environment- resistant, rectangular connectors qualified to MIL-C-83733 (USAF). They feature crimp snap-in contacts in the dependable LITTLE CAESAR® rear release contact retention assembly. This field-proven assembly permits contacts to be inserted and extracted at the rear of the connector. Contacts are qualified to military specifications and are crimped with MIL-C-22520 crimp tools, using standard locators.

The versatile DPK Connector is suitable for many applications, particularly where environment or thermal protection is mandatory and high reliability is a design requirement.

These high performance connectors are available in two shell sizes with a variety of mounting configurations. There are 13 contact arrangements available accommodating from 18 to 185 standard contacts. The standard contacts are available in sizes 12, 16, 20 and 22D. Shells are a die-cast aluminum alloy with electroless nickel finish. Insulators are a high grade, glass reinforced, resin conforming to MIL-M-14 which meets or exceeds the requirements of MIL-C-83733. Silicone rubber is used for wire sealing grommets, interfacial and peripheral seals.



How To Order

MIL-C-83733 (USAF) Nomenclature

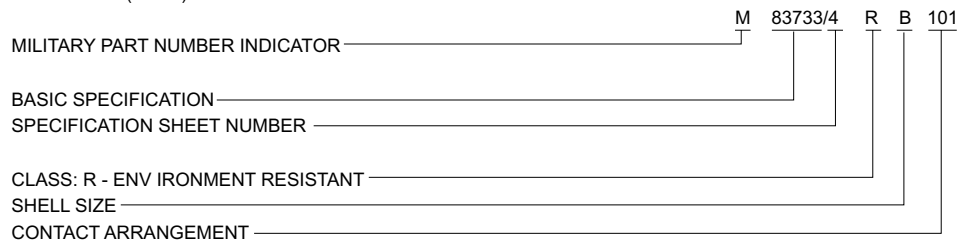

SHELL SIZE

A - Small shell

B - Large shell

CONTACT MODIFICATION

G-MIL-C-38999 contacts. Size 22D for DPKA-131 and DPKB-185 contact arrangements only.

W-MIL-C-38999 type contacts. Size 22D wrap posts for DPKA-131 and DPKB-185 layouts. .025 (0.63) square posts for .340(8.64); extension from grommet face.

CONTACT ARRANGEMENT

Shell Size A-18, 32, 51 and 131 (MIL-STD-1531).

Shell Size B-48, 64, 78, 101 59W7, 71, 71C15, 161 and 185 (MIL-STD-1532).

CONTACT TYPE

P-Pin (Receptacle Connectors)

S-Socket (Plug Connectors)

POLARIZATION

Six-position shell polarization accomplished with Polarizing pins mounted on each end of shell flange. Available on mounting style A only.

MOUNTING STYLES

A - Two mounting holes .197(5.00) diameter (for either nuts or jackscrews ordered separately) and two polarizing posts. (Replaces Mounting Style B.)

C - Four MS24700-2 bushings, included for the receptacle (M83733/5).

F - Four (4) clinch nuts jNo. 6-32 thread M83733/6.

ITT Cannon Nomenclature

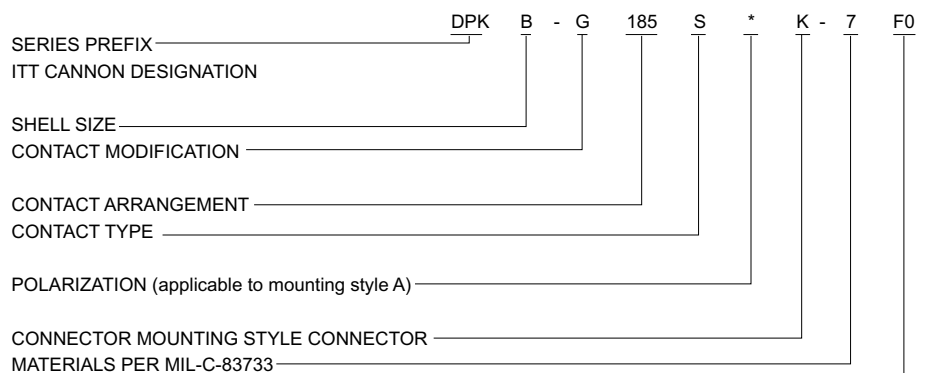

FURNISHED LESS CONTACTS (will not be stamoped a connector).

G - Four .281(7.14) diameter holes (for MS24700-2 bushings or 231-0019-000 spring mounts) (M83733/1).

H - Two mounting hole flange. Two (231-0019-000) spring mounts on the plug and two MS24700-2 bushing mounts on the receptacle (M83733/10/12).

K - Four captivated, non-rotating spring mounts on the plug (M83733/4).

M - Two mounting hole flange. Two mounting holes .281(7.14) diameter (for MS24700-2 bushings or 231-0019-000 spring mounts) (M83733/9).

X - Two guide pins with two (231-0019-000) spring mounts on the plug and two guide sockets with two .197(5.00) diameter holes on the receptacle (M83733/2; /3)

Y - Two guide sockets with two (231-0019-000) spring mounts on the plug and two guide pins with .197(5.00) diameter holes on the receptacle (M83733/7; /8).

Z - Two staggered clinch nuts on the receptacle (No. 6-32 thread) (MB3733/11).

MATERIAL MOOIRCATION

- 7 standard product line, environment resistant per MIL-C-83733(USAF). QPL M83733

Performance and Material Specifications

MATERIALS

Shell	Diecast aluminum alloy A-380 per QQ-A-591
Insulator	Thermosetting Plastic/Thermoplastic
Contacts	Copper alloy per QQ-C-533
Grommets and Seals	Silicone base elastomer
Mounting hardware	Stainless steel/Alloy steel

FINISHES

Shell	Electroless nickel plate per MIL-C-26074, Class 3
Contacts	Gold over suitable underplate per MIL-C-39029
Hardware	Passivate/Cadmium plate

MECHANICAL FEATURES

Shell Sizes	A (DPKA); B (DPKB)
Coupling	Friction, spring mount or jackscrew-coupling nut
Contact Arrangements	A-18,32,51,G131 B-48,64,78,101,59W7,71,71C15,161 G185
Contact Termination	Crimp

ELECTRICAL

Contact Sizes	Wire Accommodation (AWG)	Sealing Range Wire Diameter	
		Min.	Max.
22D	22,24,26	.030(0.76)	.060(1.52)
20	20,22,24	.040(1.02)	.083(2.11)
16	16,18	.063(1.60)	.103(2.62)
12	12,14	.081(2.06)	.158(4.01)
12	RG-179/U	.081(2.06)	.158(4.01)
Shielded			

Max. current carrying capacity of contacts

Contact Size:	#12	#16	#20	#22
Amperage:	23	13	7.5	5.0

Test Voltages (AC-RMS)

Altitude (feet)	Equivalent Pressure (Torr)	Service Ratings (M&I)				Unmated 161 Arrangement
		Mated		Unmated		
		M	I	M	I	
Sea level	-	1300	1800	1300	1800	1000
50,000	87.5	800	1000	550	600	350
70,000	35.5	800	1000	350	400	250
110,000	5.74	800	1000	200	200	150

Cross Reference From Military to Cannon Part Numbers

MIL-SPEC P/N	ITTC P/N	MIL-SPEC P/N	ITTC P/N	MIL-SPEC P/N	ITTC P/N	MIL-SPEC P/N	ITTC P/N
M83733/1RA018	DPKA-18PG-7	M83733/4RA018	DPKA-18SK-7	M83733/7RA018	DPKA-18SY-7	M83733/10RA018	DPKA-18PH-7
M83733/1RA032	DPKA-32PG-7	M83733/4RA032	DPKA-32SK-7	M83733/7RA032	DPKA-32SY-7	M83733/10RA032	DPKA-32PH-7
M83733/1RA051	DPKA-51PG-7	M83733/4RA051	DPKA-51SK-7	M83733/7RA051	DPKA-51SY-7	M83733/10RA051	DPKA-51PH-7
M83733/1RA131	DPKA-G131PG-7	M83733/4RA131	DPKA-G131 SK-7	M83733/7RA131	DPKA-G131SY-7	M83733/10RB048	DPKB-48PH-7
M83733/1RB048	DPKB-48PG-7	M83733/4RA048	DPKB-48SK-7	M83733/7RB048	DPKB-48SY-7	M83733/10RB064	DPKB-64PH-7
M83733/1RB064	DPKB-64PG-7	M83733/4RB064	DPKB-64SK-7	M83733/7RB064	DPKB-64SY-7	M83733/10RB071	DPKB-71PH-7
M83733/1RB071	DPKB-71PG-7	M83733/4RB071	DPKB-71SK-7	M83733/7RB071	DPKB-72SY-7	M83733/10RB71C	DPKB-71C15PH-7
M83733/1RB71C	DPKB-71C15PG-7	M83733/4RB71C	DPKB-71C15SK-7	M83733/7RB71C	DPKB-71C15SY-7	M83733/10RB078	DPKB-78PH-7
M83733/1RB078	DPKB-78PG-7	M83733/4RB078	DPKB-78SK-7	M83733/7RB078	DPKB-78SY-7	M83733/10RB101	DPKB-101PH-7
M83733/1RB101	DPKB-101PG-7	M83733/4RB101	DPKB-101 SK-7	M83733/7RB101	DPKB-101 SY-7	M83733/11RA018	DPKA-18PZ-7
M83733/1RB185	DPKB-G185PG-7	M83733/4RB185	DPKB-G185SK-7	M83733/8RA018	DPKA-18PY-7	M83733/11RA032	DPKA-32PZ-7
M83733/2RA018	DPKA-18SX-7	M83733/5RA018	DPKA-18PC-7	M83733/8RA032	DPKA-32PY-7	M83733/11RA051	DPKA-51PZ-7
M83733/2RA032	DPKA-32SX-7	M83733/5RA032	DPKA-32PC-7	M83733/8RA051	DPKA-51PY-7	M83733/11RB048	DPKB-48PZ-7
M83733/2RA051	DPKA-51SX-7	M83733/5RA051	DPKA-51PC-7	M83733/8RB048	DPKB-48PY-7	M83733/11RB064	DPKB-64PZ-7
M83733/2RA131	DPKA-G131SX-7	M83733/5RA131	DPKA-G131 PC-7	M83733/8RB064	DPKB-64PY-7	M83733/11RB071	DPKB-71PZ-7
M83733/2RB048	DPKB-48SX-7	M83733/5RB048	DPKB-48PC-7	M83733/8RB071	DPKB-71PY-7	M83733/11RB71C	DPKB-71C15PZ-7
M83733/2RB064	DPKB-64SX-7	M83733/5RB064	DPKB-64PC-7	M83733/8RB71C	DPKB-71C15PY-7	M83733/11RB078	DPKB-78PZ-7
M83733/2RB071	DPKB-71SX-7	M83733/5RB71C	DPKB-71C15PC-7	M83733/8RB078	DPKB-78PY-7	M83733/11RB101	DPKB-101 PZ-7
M83733/2RB71C	DPKB-71C15SX-7	M83733/5RB078	DPKB-78PC-7	M83733/8RB101	DPKB-101PY-7	M83733/12RA018	DPKA-18SH-7
M83733/2RB078	DPKB-78SX-7	M83733/5RB101	DPKB-101PC-7	M83733/9RA018	DPKA-18PM-7	M83733/12RA032	DPKA-32SH-7
M83733/2RB101	DPKB-101SX-7	M83733/5RB185	DPKB-G185PC-7	M83733/9RA032	DPKA-32PM-7	M83733/12RA051	DPKA-51SH-7
M83733/3RA018	DPKA-18PX-7	M83733/5RB071	DPKB-71PC-7	M83733/9RA051	DPKA-51PM-7	M83733/12RB048	DPKB-48SH-7
M83733/3RA032	DPKA-32PX-7	M83733/6RA018	DPKA-18PF-7	M83733/9RB048	DPKB-48PM-7	M83733/12RB064	DPKB-64SH-7
M83733/3RA051	DPKA-51PX-7	M83733/6RA032	DPKA-32PF-7	M83733/9RB064	DPKB-64PM-7	M83733/12RB071	DPKB-71SH-7
M83733/3RA131	DPKA-G131PX-7	M83733/6RA051	DPKA-51PF-7	M83733/9RB071	DPKB-71PM-7	M83733/12RB71C	DPKB-71C15SH-7
M83733/3RB048	DPKB-48PX-7	M83733/6RA131	DPKA-G131 PF-7	M83733/9RB71C	DPKB-71C15PM-7	M83733/12RB078	DPKB-78SH-7
M83733/3RB064	DPKB-64PX-7	M83733/6RB048	DPKB-48PF-7	M83733/9RB078	DPKB-78PM-7	M83733/12RB101	DPKB-101SH-7
M83733/3RB071	DPKB-71PX-7	M83733/6RB064	DPKB-64PF-7	M83733/9RB101	DPKB-101PM-7		
M83733/3RB71C	DPKB-71C15PX-7	M83733/6RB071	DPKB-71PF-7				
M83733/3RB078	DPKB-78PX-7	M83733/6RB71C	DPKB-71C15PF-7				
M83733/3RB101	DPK-101PX-7	M83733/6RB078	DPKB-78PF-7				
M83733/3RB185	DPKB-G185PX-7	M83733/6RB101	DPKB-101 PF-7				
		M83733/6RB185	DPKB-G185PF-7				

Test Data

The following is a presentation of the certified capabilities of Cannon's DPK, high performance, rectangular, rack and panel series connectors with respect to critical qualification performance and design requirements of MIL-C-83733. The data presented herein is a condensation of authentic qualification test data extracted from the original qualification reports on file at the ITT Cannon Test Laboratory.

The successful completion of the conducted qualification program clearly demonstrates the compliance of ITT Cannon, DPK series connectors and contacts to meet or exceed the performance requirements of MIL-C-83733.

Identification of Qualification Specimens
The DPK connectors listed below represent the description and identification of the test specimens

subjected to the qualification test sequence of MIL-C-83733.

DPKA-G-131PC-7 (Receptacle) DPKB-G185PC-7 (Receptacle)
DPKA-G131SK-7 (Plug) DPKA-G185SK-7 (Plug)
DPKA-G-131PC-7 (Receptacle) DPKB-G185PC-7 (Receptacle)

Table I below, lists the conducted tests executed in accordance with the applicable test paragraphs of MIL-C-83733, with the Test Level, Parameter Limits and Measured Values listed in Table 11.

TABLE 1 TEST PERFORMED

Test Description	Test Description	Test Description	Test Description
Examination Of Product	Contact Separating Forces	Low Leve Contact Resistance	Moisture Resistance
visual Examination	Connector Mating and Unmating Forces	Thermal Shock	Altitude Immersion
Sample Preparation	Contact Retention	Crimp Potential Drop	Insert Retention
Insulation Resistance - 25° C	Endurance	Vibration (Random)	Corrosion
Withstanding Voltage - Sea Level	Gold Plating Porosity	Physical Shock	Analyses
Withstanding Voltage - Altitude	Temperature Life	Ozone Exposure	Service and Storage Life
Contact Resistance	Insulation Resistance - 200° C	Fluid Immersion	Gases and Toxic or Corrosive Fumes

TABLE II

Test or Environment	Test Level or Special Requirments	Parameters Limits	Measured Values or Comments
Examination Of Product visual Examination Sample Preparation Insulation Resistance - 25° C Withstanding Voltage - Sea Level Withstanding Voltage - Altitude Contact Resistance	Assure compliance with: a) Applicable detail specifications and control drawings b) Materials c) Design and construction d) Dimensional e) Finish f) Product identification g) Workmanship	Compliance to applicable detail specification and control drawings.	Product submitted accompanied by Q.A.certificates of compliance, complied with the applicable acceptance requirements for qualification testing.
VISUAL EXAMINATION	Visual examination of qualification test specimens for completeness, workmanship, identification and /or other detrimental conditions.	Visual examination acceptance.	No visible detection of any condition detrimental to normal function.
SAMPLE PREPARATION	MIL-W-16878/4A, 28 AWG (min. dia.) and 22 AWG (max. dia.) wire. Daniels WA22A crimping tool. M22520/2-06 and M22520/2-09 contact positioner for resp.22D size socket and pin. MS7495A22M insertion and MS27495R22M removal tool.	Assemblies to conform with specified wiring and termination requirements.	Qualification test specimens prepared and terminated in accordance with specified wiring requirements. No difficulties encountered during wiring operation.
INSULATION RESISTANCE [25° C (77 F)]	Unmated condition. 50% of contact complement measured. Between adjacent contact paris and each contact and connector shell.	5.1 Gigohms minimum at 500 Vdc. Electrification Time 120 secs. maximum.	Insul. res. range (ohms) (25° C) DPKA Adj. Cont. Cont./Shell 300G-1.0T 1.1T-1.8T DPKB 400G-1.6T 1.1T-20T (Ganged parallel test circuits)
DIELECTRIC WITHSTANDING VOLTAGE (SEA LEVEL)	Unmated condition. 50% of contact complement measured. Test voltage 1350 Vac/rms-60hz, applied between adjacent contact pairs and each contact and connector shell.	No electrical breakdown, flashover or excessive current leakage.Electrification 2 secs. minimum.	No evidence of breakdown or flashover Leakage ≤.5mA. (Ganged Parallel test circuits)
SALT SPRAY (CORROSION)	Method 101, test condition B. (48 hours) unmated. Salt souldion 5% by weight. S.G. 1.026 to 1.040 at 22.8° C-23.9° C (73° F-75° F). Solution pH6.5 to 7.2 and chamber temp 33.9° C to 36.1° C (93° F to 97° F).	Visual examination. No degradation of normal connector functions.	No detrimental corrosive attack on connector's surface finish or contacts.
CONTACT RESISTANCE [AT 25° C AND 200° C (77 F AND 392 F)]	Mated condition 20% of contact complement tested. Test circuit per Fig. 2 measured across points YY performed at 25° C and 200° C (77° F and 392° F).	Max. Voltage Drop (MV) Wire 25° C 200° C Size (77 F) (392 F) 28 8 19 22 14 25	MV-Drop Range. (25° C) Wire Range Avg. Size Adc (mV) (mV) 28 1.5 2.3-5.2 3.8 22 5.0 6.3-10 8.2 (200° C) 28 1.5 9-17 11.8 22 5.0 16-21 17.8
CONTACT SEPARATING FORCES	100% of socket contact complement measured. Separating force measured on steel test pin .0294 ±.0001 (0.747 ±0.002) dia. insertion depth .205 (5.21) min. from insert face.	Separating Force (ounce-force) Min. Max. 0.6 4.9	Separating force range (ounce-force) DPKA Sep. Force Avg. Force 1.3-4.1 2.4 DPKB 1.0-2.9
CONNECTOR MATING AND UNMATING FORCES	Mating dept. ,390 (9.91) panel spacing. Total of 10 cycles mating and unmatings. Forces measured on 10th cycle.	Axial mating and unmating forces 175 pounds-force maximum.	Mating/Unmating Force (pound-force) Mate Unmated DPKA 145 34 DPKB 150 72 Forces obtained on 10th cycle.
CONTACT RETENTION	Unmated. 50% of contacts measured. 10.0 lbf applied to contact engaging end. Zero reference at 2.0 lbf preload. Displacement measured under spec. load.	Max. contact displacement under 10.0 lbf load .011 (0.28) maximum.	Contact Displacement Range (inch) DPKA Avg. Pins 0.002-0.003 0.0027 Sockets 0.002-0.004 0.0031 DPKB Pins 0.002-0.004 0.0027 Sockets 0.002-0.003 0.0026
ENDURANCE (DURABILITY)	Mating dept. ,450 (11.43) panel spacing. Total of 500 cycles mating and unmating at a rate of 300 cycles/hour maximum.	Withstand 500 cycles of durability conditioning without detrimental effects to function.	No detrimental damage. Connectors fully functional.

Test Data (Continued)

(TABLE II Continued)

Test or Environment	Test Level or Special Requirements	Parameters Limits	Measured Values or Comments
THERMAL SHOCK	Mated condition. Five continuous cycles of temperature change. 30 mins. exposure at each temp. extreme constitutes one cycle. Transfer time between chambers 2 mins. max. temp. extremes: - 54 ± 3° C and 200 ± 3° C (-??' +_ 5.4°F and 392 ± 5.4°F).	Withstand temperatre cycling. No damage.	No apparent damage.
CRIMP POTENTIAL DROP	20% of the contacts in each connector measured. Test circuit per Fig. 2 measured across points X-X and X'-X'.	Max. crimp potential drop: Wire Size M.V. 28 2.8 22 7.0	Crimp mV drop range. DPKA (sockets) Adc Range Avg. 1.5 1.7-2.1 1.8 (Pins) 1.5 1.1-1.6 1.3 DPKB (sockets) Adc Range Avg. 5.0 1.8-2.4 2.1 (Pins) 5.0 1.4-1.8 1.5
DIELECTRIC WITHSTANDING VOLTAGE (ALTITUDE)	Mated condition. 50% of contact complement measured. Performed at simulated altitude of 70,000 ft. (33.7 mm Hg pressure) Test voltage 825 Vac/rms-60 Hz, applied between adjacent contact pairs and each contact and connector shell.	Same as at sea level conditions.	No evidence of breakdown or flashover. Leakage ≤5mA. (Ganged Parallel test circuits)
INSULATION RESISTANCE ELEVATED TEMP.[200° C (392° F)]	Unmated condition. 50% of contact complement measured. Test points identical to those measured at 25° C (77° F). Oven ambient controlled at 200° C (392° F). Stabilization period 30 minutes minimum.	204 Megohms minimum at 500 Vdc. Electrification time 120 secs. maximum,	Insul. Res. range (ohms) [200° C (392° F)] DPKA Adj. Cont. Cont./Shell 1.4G-10G 2.4G-4.0G DPKB 0.75G-10G 2.26G-5.0G (Ganged parallel test circuits)
VIBRATION (RANDOM)	Method 214, Test condition II, Letter 'G'. Test level envelope per figure and table 214-2. Contact circuit senes wired far current discontinuity monitoring. Eight hours duration in each of three mutually peipendiciuar axes. Connector mating depth .450 (11.43) panel spacing.	No current discontinuity ≥ 1.0 microsec. No cracking, breaking or loosening of connector parts.	Connectors met random vibration requirements. No electrical discontinuity detected.
PHYSICAL SHOCK	Mated condition, .450 (11.43) panel spacing. Shock pulse duration ± 1 mS, waveshape terminal peak smooth, peak amplitude 20g. Contact circuit series wired for current discontinuity monitoring. One shock pulse in each of three mutually perp. axes.	No current discontinuity ≥ 1.0 microsec. No cracking, breaking or loosening of connector parts.	Connectors met physical shock requirements. No electrical discontinuity or damage detected.
MOISTURE RESISTANCE	Method 106, (Step 7b) ommed) Mated condition. 10 days humidity and temperature cycling. At end Step 6 final cycle at 25° C (77° F) and 90-98% RH insulation resistance in asured 100% between each and ail other contacts and the shell in parallel circuit.	Insulation resistance at final humidity cycle 102 Megohms minimum at 50 Vdc.	Insul. Res. range (ohms) final humidity cycle. DPKA DPKB 1.66-500G 1.6-500G Avg: 224G Avg: 190G
ALTITUDE IMMERSION	Mated condition. Immersed in 5% sail solution by weight. Unsealed wire ends exposed to chamber atmosphere. Simulated test altitude 75,000 ft. (1.0 inch Hg). 30 mins. at altitude followed by 15 mins. at room ambient, Repeat for total of 3 cycles. Insul. res. and OWV measured 100% of contact complement at room ambient and submerged.	Insulation resistance 1.2 Gigohm minimum at 5 Vdc. DWV 1350 Vac/rms - 60 Hz, electrification time 60 secs. minimum. No breakdow, flashover or leadage ≤ 2 mA,	Final insul. Res ranges (ohms). DPKA DPKB 1.5T-4.5T 0.7-3.5T Avg. 1.9T Avg: 1.3T DWV - No evidence of insert movement and /or dislocation from normal position
INSERT RETENTION	Unmated. 46 lbf/in. ² pressure lead applied to each inert face at 5 lbf/in. ² sec.. maintained for 5 secs. min. at specified load.	No insert disociation from normal position in the connector shell.	No evidence of insert movement and/or dislocation from normal position.
OZONE EXPOSURE	Unmated. Ozone concentration 0.010 to 0.015 percent by volume. Exposure period 2 hours minimum at room temperature.	No deterioration.	No evidence of ozone effects.
FLUID IMMERSION	Fluid immersion rest fluids and procedures per Table 4: Sample No. Test Fluid 4-1P/R MIL-L-7808 4-2P/R MIL-L-23699 4-3P/R M2-V CHEVRON 4-4P/R MIL-H-5606 4-5P/R MIL-A-8243 4-6P/R MIL-C-25769 4-7P/R MIL-T-5624 (JP-5) 4-8P/R Coolanol-25 4-9P/R Regular (Leaded commercial auto-gasoline 4-10P/R Solvent (a) MIL-STD-202 4-11P/R Solvent (b) MIL-STD-202 4-12P/R Solvent (c) MIL-STD-202	No detrimental damage of effects to connector performance. Axial Mate and unimate forces after fluid immersion 175 lbf max.	Other than evidence of normal light swelling of the connector resilient seals, the samples did not exhibit any dertirmental affects. Mateability was not imparied. After Fluid Immersion Mating/Unmating forces (Pound-Force) DPKA Mate Unmated DPKB Mate Unmated 4-1P/R 125 27 4-7P/R 138 71 4-2P/R 125 31 4-8P/R 141 57 4-3P/R 127 35 4-9P/R 137 63.5 4-4P/R 132 35 4-10P/R 145 76 4-5P/R 132 63 4-11P/R 150 81 4-6P/R 123 55 4-12P/R 148 86
GOLD PLATING POROSITY	Unwired. wouissembled contact bodies. One part (by volume) concentrated Nitric Acid (S.G.-1.42) to we part distilled water. 30 secs. minimum immersion period.	No visible reaction (bubbles forming) to reagent.	No evidence of reaction to reagent.
TEMPERATURE LIFE W/CONTACT LOADING	Wired mated condition, with contacts under specific load: #220 (5 lbs.); #16 12.5 lbs. A current of 100 MA was applied during life of test. Test duration, 1000 hours at temperature of + 200° C (392° F).	Withstand temp life. No damage. No discontinuity higher than 1.0 microsecond. No contact dislodging order load.	No evidence of contact dislodging and/or electrical discontinuity of 1.0 microsecond or greater during the specified temperature life exposure under contact loading conditions. All post test requirements were met.

Conclusion

All subject test specimens, connector components, materials, accessories and contacts covered by this report satisfied and/or exceeded the specified requirement.

The successful completion of the qualification program as reported herein, demonstrates the capabilities of the subject ITT Cannon DPK series connectors to comply with stringent verification

qualification requirements in accordance with MIL-C-83733. On the basis of testing, the DPK connector series was granted full OPI status to MIL-C-83733.

Weights

The following are weights for DPK connector assemblies, mounting hardware, contacts, and sealing plugs. All connector weights are listed less contacts (FO) and mounting hardware. The total connector weight is obtained by adding mounting hardware, contacts, and sealing plugs weight to the connector assembly weight.

Example:

DPKB-101SK-7 (with 90 contacts and 11 sealing plugs)

	Weight Pounds	Weight Grams
DPKB-101SG-7-FO	.2332	105.78
Type K Spring Mount	.0825	37.42
90 Number 20 Socket Contacts	.0639	28.98
11 Number 20 Sealing Plugs	.0020	.88
	.3816	173.06
Maximum Connector Weight		

Part Number (Description)	Maximum Weight	
	Lbs.	Grams
DPKA-18PG-7-F0	.1474	66.86
DPKA-18SG-7-F0	.1496	67.86
DPKA-32PG-7-F0	.1496	67.86
DPKA-18SG-7-F0	.1518	68.86
DPKA-51PG-7-F0	.1529	69.35
DPKA-51SG-7-F0	.1551	70.35
DPKA-G131PG-7-F0	.1045	47.40
DPKA-G131SG-7-F0	.1077	48.85
DPKB-48PG-7-F0	.2398	108.77
DPKB-48SG-7-F0	.2486	112.76
DPKB-59W7PG-7-F0	.2354	106.78
DPKB-59W7SG-7-F0	.2442	110.78
DPKB-64PG-7-F0	.2354	106.78
DPKB-64SG-7-F0	.2442	110.78
DPKB-71PG-7-F0	.2288	103.78
DPKB-71SG-7-F0	.2332	105.78
DPKB-71C15PG-7-F0	.2288	103.78
DPKB-71C15SG-7-F0	.2332	105.78
DPKB-78PG-7-F0	.2266	102.78
DPKB-78SG-7-F0	.2288	103.78
DPKB-101PG-7-F0	.2288	103.78
DPKB-101SG-7-F0	.2332	105.78
DPKB-G185PG-7-F0	.1628	73.85
DPKB-G185SG-7-F0	.1650	74.85
#12 Pin, 030-9185-003	.00298	1.353
#12 Skt, 030-9186-003	.00291	1.318
#16 Pin, 030-9205-007	.00135	.611
#16 Skt, 030-9206-006	.00146	.664
#20 Pin, 030-9173-006	.00062	.280
#20 Skt, 031-9174-004	.00071	.322
#22D Pin, 030-2042-000	.00021	.093
#22D Skt, 031-1147-000	.00025	.111
#12 Shielded Pin, 249-1825-001	.00206	.943
#12 Shielded Skt, 249-1826-000	.00258	1.168
#8 Coaxial Pin, 59W7 Layout	.00420	1.910
#8 Coaxial Skt, 59W7 Layout	.00650	2.948
Type C Bushing, 012-0515-000 (4 reqd)	.00606	2.750
Type K Spring Mtg Captive (non-rotate)	.08250	37.42
Type F Nut (4 reqd)	.00072	.325
Type G Spring Mtg 231-0019-000 (4 reqd)	.01180	5.350
Size 22; 225-1013-000	.00006	.027
Size 20; 225-0070-000	.00018	.080
Size 16; 225-0071-000	.00036	.163
Size 12; 225-0072-000	.00064	.291
SEALING PLUGS		

Receptacle (Pin Contacts)

BASIC RECEPTACLE SHELL DIMENSIONS

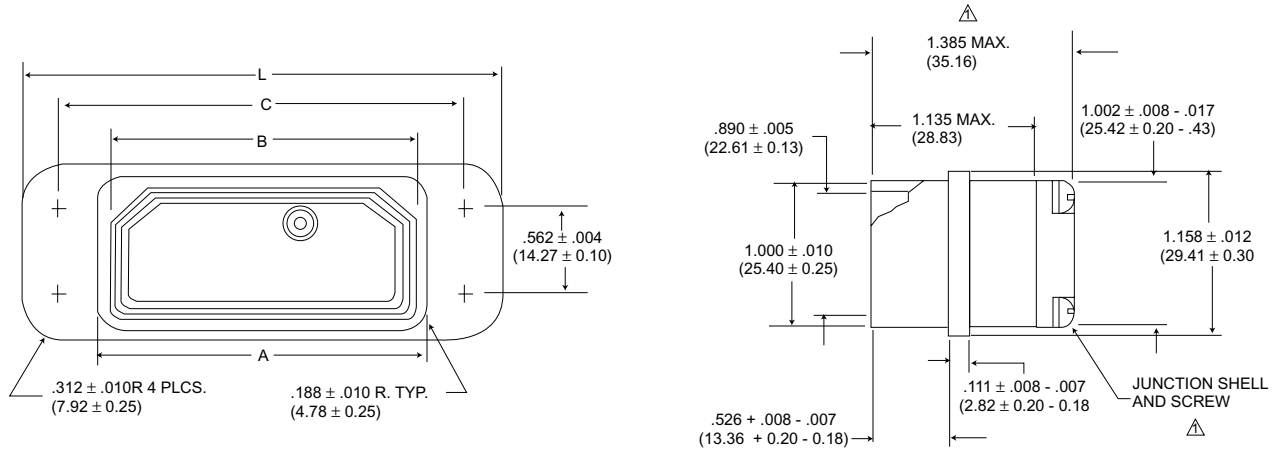

△ Junction shell and screws are not supplied on -G131 and -G185 layouts.

SHELL SIZE	A	B	C	L	N Staggered †
DPKA*P**	2.085 (52.96)	1.976 (50.19)	2.580 (65.58)	3.030 (76.96)	2.150 (54.61)
DPKB*P**	2.072 (52.63)	1.961 (49.81)	2.570 (65.38)	3.000 (76.20)	2.130 (54.10)
DPKC*P**	3.385 (85.98)	3.281 (83.34)	3.880 (98.53)	4.330 (109.98)	3.450 (87.63)
DPKD*P**	3.372 (85.65)	3.261 (82.83)	3.870 (98.32)	4.300 (109.22)	3.430 (87.12)

†See Page 81 Style M and Z

DPK TYPES

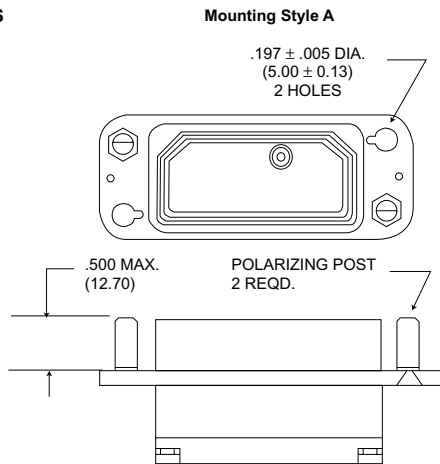

Mounting Dimensions for Coupling Nut Assemblies

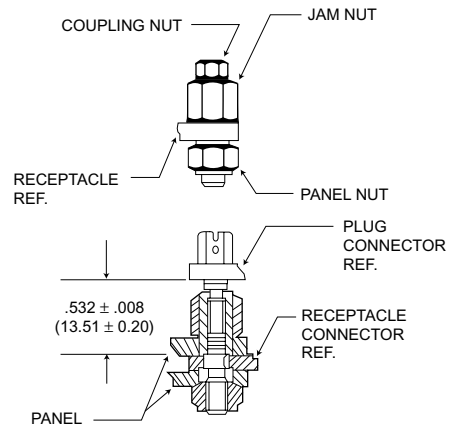

DPK/MIL-C-83733 TYPES

Mounting Style G
Standard Hole Mounting MIL-C-83733/1(USAF)

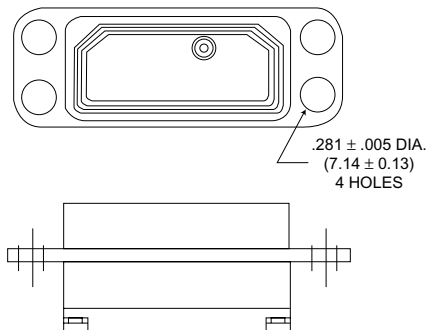

Mounting Style F Clinch Nut Mounting
MIL-C-83733/6(USAF)

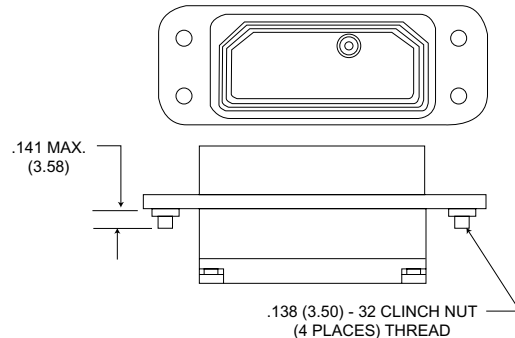

Receptacle/Configurations (Pin Contacts)

DPK/MIL-C-83733 TYPES

Mounting Style C
Bushing Mounting MIL-C-83733/5(USAF)

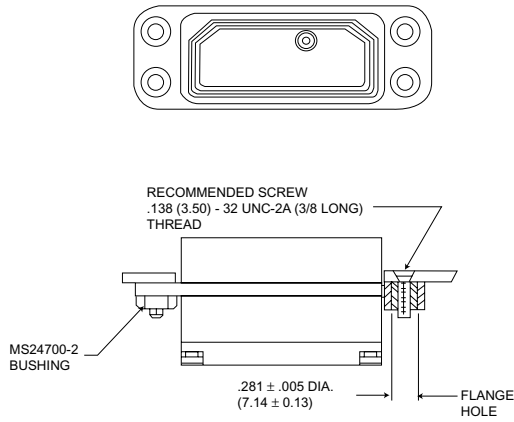

Mounting Style X
With Guide Sockets MIL-C-83733/3(USAF)

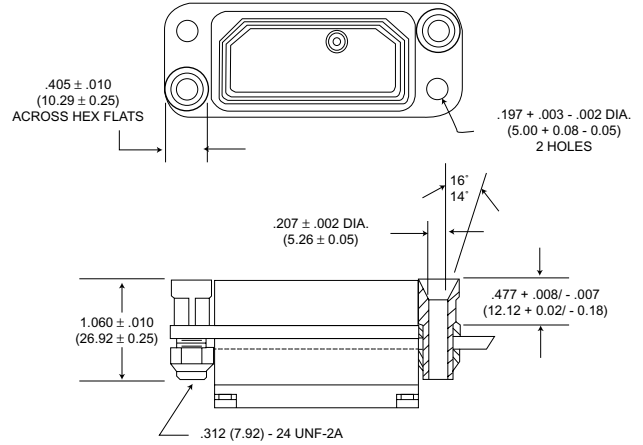

DPK/MIL-C-83733 TYPES

Mounting Style Y
With Guide Pins MIL-C-83733/8(USAF)

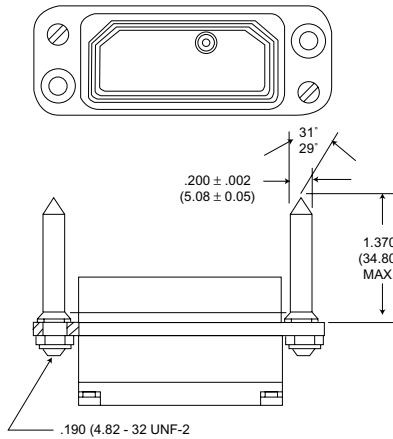

Mounting Style M
Staggered Standard Hole Mounting MIL-C-83733/9(USAF)

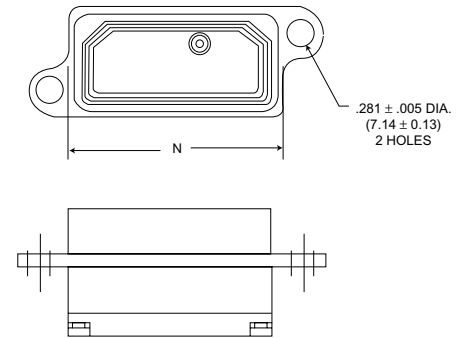

Mounting Style H
Staggered Bushing Mounting MIL-C-83733/10(USAF)

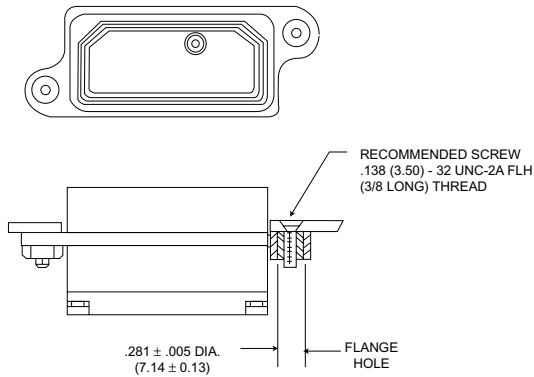

Mounting Style Z
Staggered Clinch Nut Mounting MIL-C-83733/11(USAF)

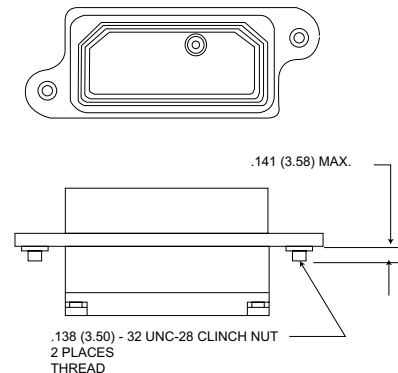

Plugs/Configurations (Socket Contacts)

Basic Plug
Shell Dimensions

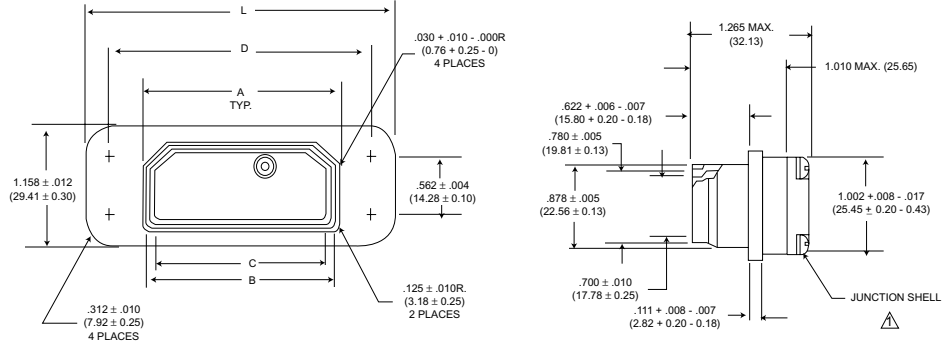

SHELL SIZE	A	B	C	D	L	N Staggered †
DPKA*S**	1.959 (49.76)	1.864 (47.35)	1.780 (45.21)	2.580 (65.53)	3.030 (76.96)	2.150 (54.61)
	1.946 (49.43)	1.853 (47.07)	1.763 (44.78)	2.570 (65.28)	3.000 (76.20)	2.130 (54.10)
DPKB*S**	3.259 (82.78)	3.164 (80.37)	3.080 (78.23)	3.880 (96.52)	4.330 (109.98)	3.450 (87.63)
	3.246 (82.45)	3.153 (80.09)	3.063 (77.80)	3.870 (98.30)	4.300 (109.22)	3.430 (87.12)

⚠ Junction shell and hardware are not supplied on -G131 and -G185 layouts.
† See page 83 Style M and H

DPK Styles

Mounting Style A

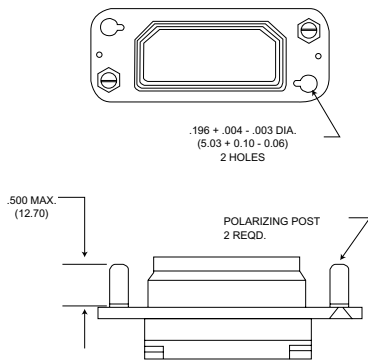

Mounting Spacing Dimensions
For Jackscrew Assemblies

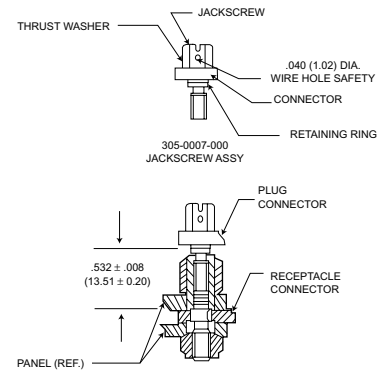

DPK/MIL-C-83733 TYPES

Mounting Style K - MIL-C-83733/4(USAF)
With Captive Springs

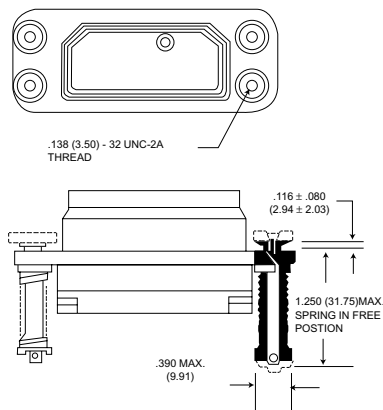

NOTES: 1. Springs are pre-loaded to 25 pounds each in free position.
2. Spring forces will be 118 pounds minimum at .500 (12.70) panel spacing and 176 pounds maximum at .390 (9.91) panel spacing

Mounting Style X - MIL-C-83733/2(USAF)
With Guide Pins and Spring Mounting

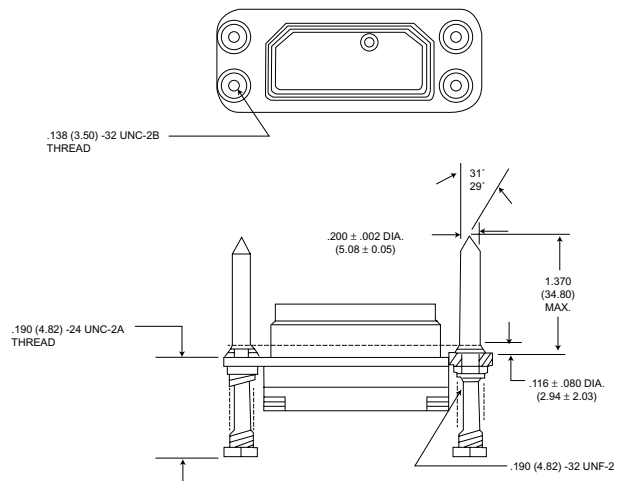

NOTES: 1. Springs are pre-loaded to 25 pounds each in free position.
2. Spring forces will be 59 pounds minimum at .500 (12.70) panel spacing and 88 pounds maximum at .390 (9.91) panel spacing
3. This configuration must not be used on teh 131 or 185 contact layouts.

Plugs/Configurations (Socket Contacts)

DPK/MIL-C-83733 TYPES

Mounting Style Y - MIL-C-83733/7(USAF)
With Guide Sockets and Spring Mounting

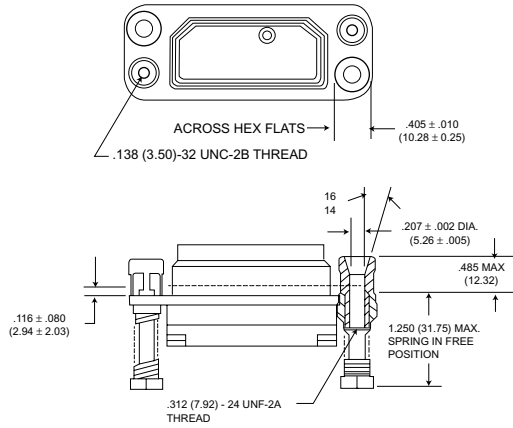

- NOTES: 1. Springs are pre-loaded to 25 pounds each in free position.
2. Spring forces will be 59 pounds minimum at .500 (12.70) panel spacing and 88 pounds maximum at .390 (9.91) panel spacing

Mounting Style H - MIL-C-83733/12(USAF)
Staggered Spring Mounting

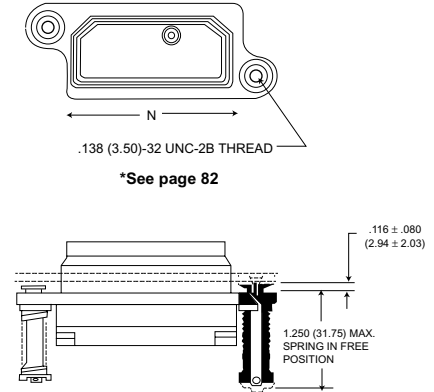

*See page 82

- NOTES: 1. Springs are pre-loaded to 25 pounds each in free position.
2. Spring forces will be 59 pounds minimum at .500 (12.70) panel spacing and 88 pounds maximum at .390 (9.91) panel spacing
3. This configuration must not be used on teh 131 or 185 contact layouts.

DPK Commercial Types

Mounting Style G
Standard Hole Mounting

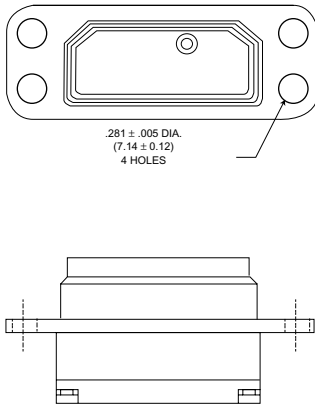

Mounting Style F
Clinch Nut Mounting

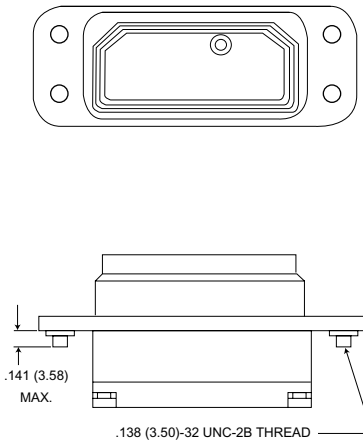

Mounting Style M
Mounting

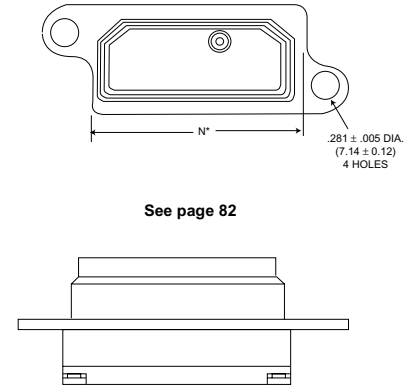

See page 82

Mounting Styles/Applications

DPK connectors for rectangular or staggered mounting are available in both two- and four-spring mount assemblies, or the same shelf style may be ordered to accommodate bushing assemblies. In the spring mount version the spring-loaded mechanism will compensate for a panel space variation of up to .070(1.78) while insuring electrical and environmental integrity.

DPK connectors are also available with polarizing posts, accommodations for jackscrews, and coupling nuts for cord-to-card and cord-to-panel applications. Another shelf style has two or four mounting holes fitted with captive clinch nuts. For mounting dimensions of the various mounting styles shown here please refer to page 87.

Style A

Mounting style A is designed for cord-to-panel and cord-to-cord applications. Connectors are supplied with two polarizing posts installed and provisions for installation of two jackscrew assemblies or two coupling nut assemblies. (Replaces Mounting Style B.)

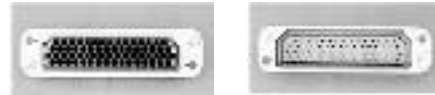

**Plug
Socket Contacts**

**Receptacle
Pin Contacts**

Ordered Separately



**Jackscrew Assembly
305-0007-000**

**Coupling Nut Assembly
335-0002-000**

Style C

Mounting style C is designed for cord-to-panel or rack-to-panel applications. Connectors are supplied with (4) MS24700-2 bushings on the receptacle and 4 spring mount assemblies on the plug.

M83733/5



**Receptacle
Pin Contacts**

Supplied with Connector



**Bushing MS24700-2
(Self-Locking)
012-0515-000**

**Spring Mount Assembly
MIL-C-83733/17
231-00019-000**

Style F

Mounting Style F is designed for rack-to-panel applications. Connectors are supplied with four captive clinch nuts installed.

M83733/6



**Receptacle
Pin Contacts**

Style G

Mounting style G is designed for rack-to-panel applications. Connectors are supplied with four .281(7.14) diameter holes which will accommodate either four MS24700-2 bushings or four 231-0019-000 spring mounts,

M83733/1



**Plug
Socket Contacts**

**Receptacle
Pin Contacts**

Ordered Separately



**Bushing MS24700-2
(Self-Locking)
012-0515-000**

**Spring Mount Assembly
MIL-C-83733/17
231-0019-000**

Style H

Mounting style H is designed for rack-to-panel applications. Connectors are supplied with two .281(7.14) diameter holes which are staggered. Two spring mounts are on the plug end two MS24700-2 bushings are on the receptacle.

M83733-12



**Plug
Socket Contacts**

M83733-10



**Receptacle
Pin Contacts**

Supplied with Connector



**Bushing MS24700-2
(Self-Locking)
012-0515-000**

**Spring Mount Assembly
MIL-C-83733/17
231-0019-000**

Style K

Mounting style K is designed for rack-to-panel applications. Connectors are supplied with four captivated, non-rotating spring mounts on the plug.

M83733/4



**Plug
Socket Contacts**

Style M

Mounting style M is designed for rack-to-panel applications. Connectors are supplied with two .281 (7,14) diameter holes which are staggered and will accommodate eight two MS24700-2 bushings or two 231-0019-000 spring mounts.

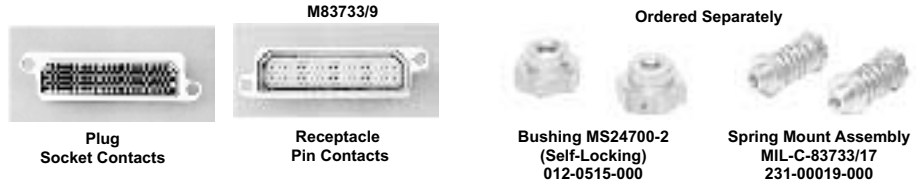

Style X

Mounting style X is designed for rack-to-panel applications where positive alignment is required before connectors are mated. Plug has two guide pins and two spring mounts (MIL-STO-1533); receptacle has two guide sockets and two .197 (5.00) dia. holes.

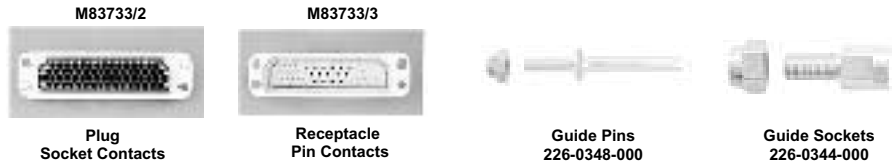

Style Y

Mounting style Y is identical to mounting style X, Xcept the guide sockets are on the plug and the guide pin and springs are on the receptacle.

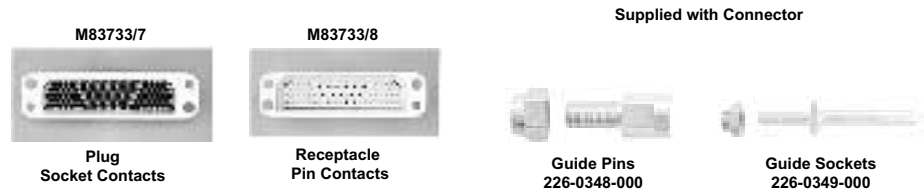

Style Z

Mounting style Z is designed for use in rack-to-panel applications. Connectors are supplied with two captive clinch nuts which are staggered.



MIL-C-83733/DPK Mounting Style

MIL-C-83733 Connector Type	DPK Mtg. Style	Mating MIL-C-83733 Connector	DPK Mtg. Style
M83733/1 RECEPTACLE	G	M83733/4	K
M83733/2 PLUG	X	M83733/3	X
M83733/3 RECEPTACLE	X	M83733/2	X
M83733/4 PLUG	K	M83733/1	G
		M83733/5	C
		M83733/6	F
M83733/5 RECEPTACLE	C	M83733/4	K
M83733/6 RECEPTACLE	F	M83733/4	K
M83733-07 PLUG	Y	M83733/8	Y
M83733-08 RECEPTACLE	Y	M83733/7	Y
M83733-09 RECEPTACLE*	M	M83733/12	H
M83733-10 RECEPTACLE*	H	M83733/12	H
M83733-11 RECEPTACLE*	Z	M83733/12	H
M83733-12 RECEPTACLE	H	M83733/9	M
		M83733/10	H
		M83733/11	Z

*Not recommended for G131 and G185 layouts.

Polarization (Mounting Style A only)

Polarizing Post Alternate Positions

Pin inserts polarizing positions are 180° opposite socket insert polarizing positions. Shaded areas indicate extended portion of the polarizing post. Cord to panel DPK connectors are available in 35 alternate polarizing positions by changing indexing of the polarizing posts. Keystone corners and hexagonal posts provide this wide range of alternate positions. Face view of socket insert plug connector engaging end.

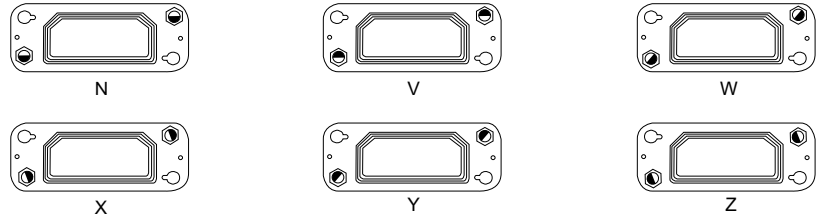

Contact Data

Standard Contacts

Contact Size	Type	Cannon Part Number	MIL-C-39029 Military Part Number	Crimp Tool	Insertion/ Extraction Tool	Grommet Sealing Plug Part Number (Color)
12	Pin Skt.	030-9185-003 031-9186-003	M39029/4-113 M39029/5-118	M22520/1-01 with M22520/1-02 Turret	MIL-I-81969/14-04 MIL-I-81969/14-03	225-0072-000 (Yellow) 225-0071-000 (Blue)
16	Pin Skt.	030-9205-007 031-9206-006	M39029/4-111 M39029/5-116	M22520/2-01 with M22520/2-02 Turret	MIL-I-81969/14-11	225-0070-000 (Red)
20	Pin Skt.	030-9173-006 031-9174-004	M39029/4-110 M39029/5-115	M22520/2-01 with M22520/2-23 Turret	MIL-I-81969/14-01	225-1013-000 (Black)
22	Pin Skt.	030-1975-008 031-1113-008	M39039/11-144 M39029/12-148	M22520/2-01 with M22520/2-06 (Socket) Turret M22520/2-09 (Pin) Turret	MIL-I-81969/14-01	
22D	Pin Skt.	030-2042-000 031-1147-000	M39029/58-360 M39029/57-354			

Coaxial/Shielded Contacts

Coaxial	Type	Prefix	Cannon Part Number	Cable Accom.	DWV Voltage	Min./Max. O.D. Wire Accom.	Crimp Tool	Ins./ Ext. Tool	Grommet Sealing Plug Part Number (Color)
Coaxial Contacts* △59W7 Arrangement Only	Plug Receptacle	G G	249-5500-012 249-5500-013	RG-316	500 VDC	.122 (3.10) .250 (6.35)	CCTC8 Outer M22520/2-01 M22520/2-30	CET-C8	225-0085-00 (White)
	Plug Receptacle	F F	249-5500-010 249-5500-011	RG-180/U	500 VDC	.122/250	CCTC9 Outer M22520/2-01 M22520/2-30	CET-C8	

*Plug coaxials go into plug connectors (59W7S inserts with socket contacts). Receptacle coaxials go into receptacle connectors ("P" inserts) with pin contacts (59W7P inserts with pin contacts).

Coaxial	Type	Cannon Part Number	MIL-C-39029 Part Number	Cable Accom.	Min./Max Cable Dia.	Crimp Tool	Locator	Ins./ Ext. Tool	Grommet Sealing Plug Part Number (Color)
Size 12 Contact 71C15 Layout Only	Pin Socket	249-1825-001 249-1826-000	M39029/50-340 M39029/51-341	RG-179U	.081 (2.06) .158 (4.01)	.M22520/5-01 Outer M22520/2-01 Inner	.M22520/5-08 Outer M22520/2-30 Inner	CIET - 12	225-0072-000 (Yellow)

*Pin shielded contacts utilized in receptacle connectors (71C15P inserts). Socket shielded contacts utilized in plug connectors (71C15S inserts).

Contact Arrangements

DPKA

Face View Pin Insert Shown

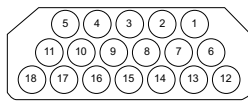

18
18 #12

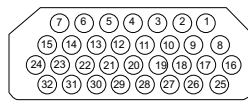

32
32 #16

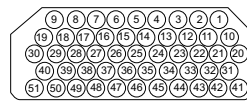

51
51 #20

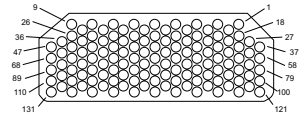

G131
131 #220

Layout
No. of Contacts
and Wire Size
Service Rating

I

I

I

M

DPKB

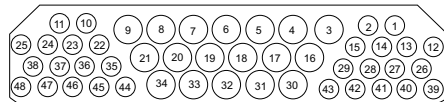

48
30 #16 (1,2,10-15,22-29,35-48),
18#12 (3-9,16-21,30-34)

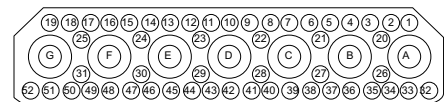

59W7
52 #20 (1-52)
7 Coax. (A-G)
#20: 1500 Coax: 1000
I & 500 VDC (Coax)

The 59W7 Layout is sold less coaxial contacts, see page 86 for contact part numbers.

Layout
No. of Contacts
and Wire Size
Service Rating

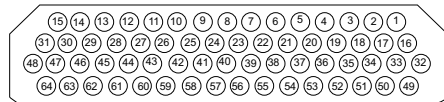

64
64 #16

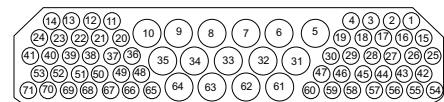

71
56#20 (1-4,11-30,36-60,65-71)
15 #12 (5-10,31-56,61-64)

Layout
No. of Contacts
and Wire Size
Service Rating

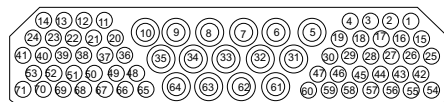

71C15
56 #20 (1-4,11-30,36-60,65-71)
15 Shielded #12 (5-10, 31-35,61-64)
#20: 1500: #12 Shielded: 500
1&500 VDC (Coax)

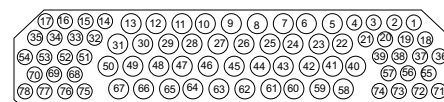

78
38 #20 (1-4,14-21,32-39,51-57,
68-78),40 #16 (5-13, 22-31,
40-50,58-67)

Layout
No. of Contacts
and Wire Size
Service Rating

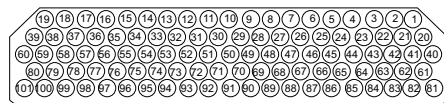

101
101 #20

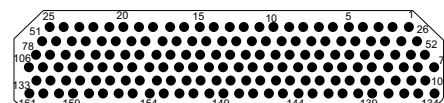

161*
161 #22
1000 VDC

Layout
No. of Contacts
and Wire Size
Service Rating

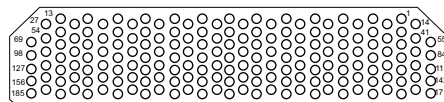

G185
185 #22D

Layout
No. of Contacts
and Wire Size
Service Rating

M

***POS-ALINE DESIGN**

In the 161 contact arrangement, the entire pin contact is recessed in and individual cavity in the plug connector. The socket contact is exposed and extends from the connector receptacle face. (Pin insulator accepts socket contacts.)

Panel Cutout Dimensions

Mounting Styles

PG, SG SY, PY
 PC, PF, SF S*A, S*B
 SX, PX, SK P*A, P*B

Figure 1.

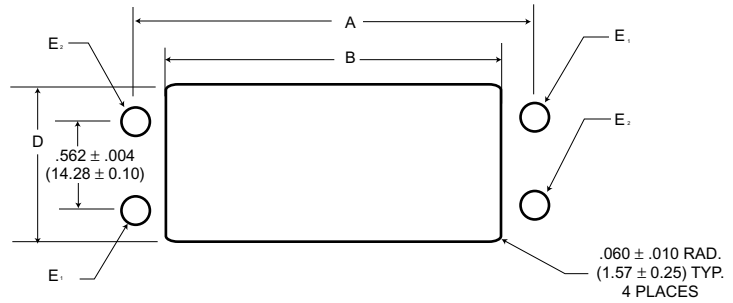

Mounting Styles

SH, SM

Figure 2.

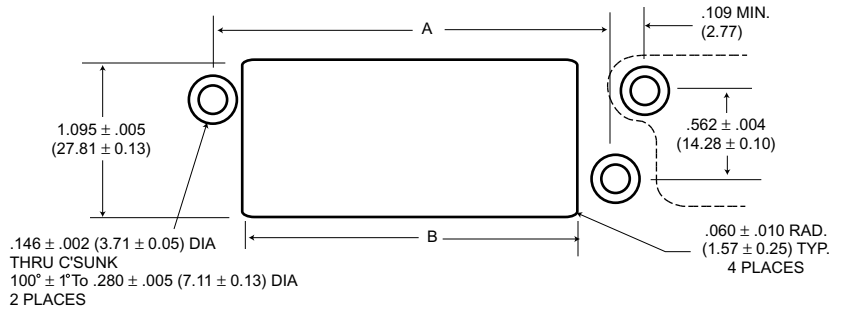

Mounting Styles

PM, PH, PZ

Figure 3.

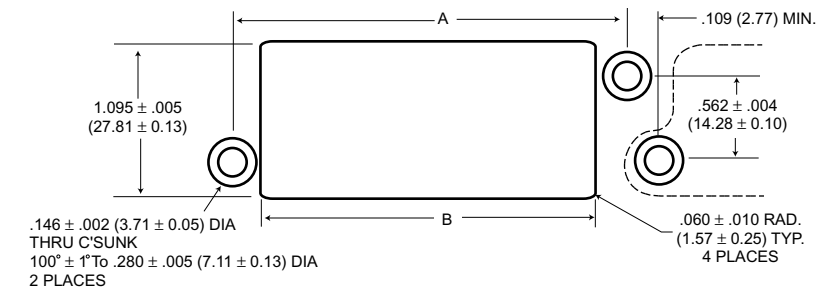

MIL-C-83733 Part No./ Mounting Style	DPK Mounting Styles	Figure Ref.	A ± .004(± 0.10)		B ± .005(± 0.13)		D ± .005(± 0.13)		E ₁		E ₂	
			Shell Size A	Shell Size B	Shell Size A	Shell Size B	Shell Size A	Shell Size B	Shell Size A	Shell Size B	Shell Size A	Shell Size B
M83733/1/5/6	PG, SG, PC, PF,SF	1	2.578 (65.48)	3.875 (98.43)	2.103 (51.13)	3.400 (86.36)	1.022 (25.96)	1.022 (25.96)	.148 (3.76) .144 (3.66)	.148 (3.76) .144 (3.66)	.148 (3.76) .144 (3.66)	.148 (3.76) .144 (3.66)
M83733/2	SX	1	2.578 (65.48)	3.875 (98.43)	2.103 (51.13)	3.465 (88.01)	1.022 (25.96)	1.095 (27.81)	.148 (3.76) .144 (3.66)	.148 (3.76) .144 (3.66)	.260 (6.60) .250 (6.35)	.260 (6.60) .250 (6.35)
M83733/3	PX	1	2.578 (65.48)	3.875 (98.43)	2.103 (51.13)	3.465 (88.01)	1.022 (25.96)	1.095 (27.81)	.320 (8.13) .315 (8.00)	.320 (8.13) .315 (8.00)	.148 (3.76) .144 (3.66)	.148 (3.76) .144 (3.66)
M83733/4	SK	1	2.578 (65.48)	3.875 (98.43)	2.167 (55.04)	3.465 (88.01)	1.095 (27.81)	1.095 (27.81)	.148 (3.76) .144 (3.66)	.148 (3.76) .144 (3.66)	.148 (3.76) .144 (3.66)	.148 (3.76) .144 (3.66)
M8733/7	SY	1	2.578 (65.48)	3.875 (98.43)	2.167 (55.04)	3.465 (88.01)	1.095 (27.81)	1.095 (27.81)	.148 (3.76) .144 (3.66)	.148 (3.76) .144 (3.66)	.430 (10.92) .420 (10.67)	.430 (10.92) .420 (10.67)
M83733/8	PY	1	2.578 (65.48)	3.875 (98.43)	2.167 (55.04)	3.465 (88.01)	1.095 (27.81)	1.095 (27.81)	.380 (9.65) .370 (9.40)	.380 (9.65) .370 (9.40)	.148 (3.76) .144 (3.66)	.148 (3.76) .144 (3.66)
M83733/9/10/11	PM, PH PZ	2	2.578 (65.48)	3.875 (98.43)	2.167 (55.04)	3.465 (88.01)	1.095 (27.81)	1.022 (25.96)	-	-	-	-
M83733/12	SH, SM	3	2.578 (65.48)	3.875 (98.43)	2.095 (53.21)	3.400 (86.36)	1.095 (27.81)	1.095 (27.81)	-	-	-	-
N/A	S*A, S*B, P*A, P*B	1	2.578 (65.48)	3.875 (98.43)	2.103 (51.13)	3.465 (88.01)	1.022 (25.96)	1.095 (27.81)	.301 (7.65) .294 (7.45)	.301 (7.65) .294 (7.45)	.301 (7.65) .294 (7.45)	.301 (7.65) .294 (7.45)

Mounting Assembly-Jackscrew/Coupling Nut

Installatoin of jackscrew and coupling nuts in mounting style A and B.

CORD-TO-CORD INSTALLATION

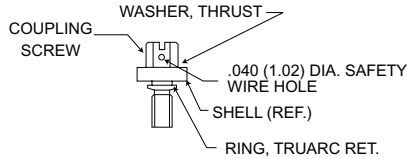
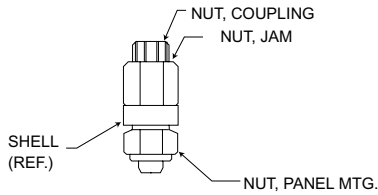

PANEL MOUNTING

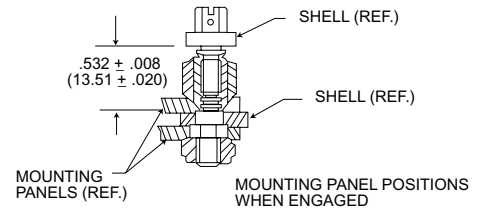

Mounting Assembly-Bushing/Spring Mount

Installatoin of mounting styles utilizing bushing and spring mount assemblies.

PLUGS

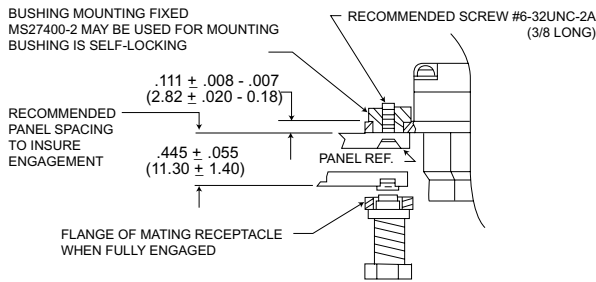

SPRING, FLOAT MOUNTING ASSEMBLY MAY BE USED FOR MOUNTING MIL-C-83733/17

RECOMMENDED SCREW #6-32UNC-2A (3/8 LONG) WITH TEFLON PELLETT (SELF-LOCKING)

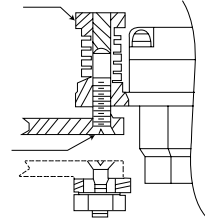

RECEPTACLES

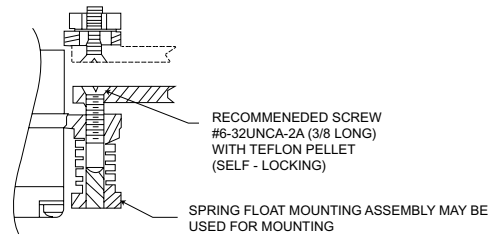
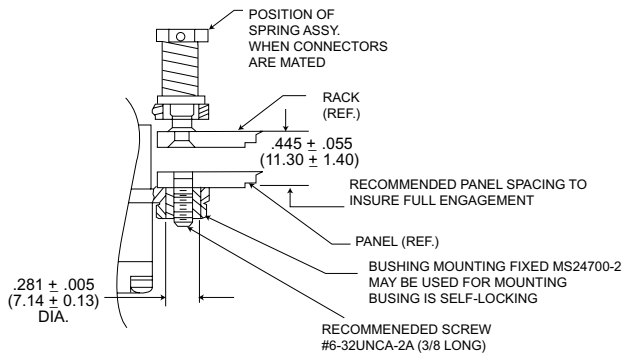

Mating Forces

The axial forces required to fully mate or separated the plug and receptacle shall not exceed the values listed.

Mating force at .390 (9.91) minimum spacing

Shell Size	Without mounting accessories		Spring mounting	
	Maximum	Normal	Maximum	Normal
A	70 max.	145	176	145
B	95 max.	150	176	150

For connectors using spring mounting, the mating forces become a function of the spring loading. Values listed apply to connectors mounted as specified above at minimum panel spacing.

Dust Covers

PLASTIC TYPE

Series	Style		Standard	Conductive
DPKA	Receptacle	DPKA-60	025-0773-000	025-0773-001
	Plug	DPKA-59	025-0772-000	025-0772-001
DPKB	Receptacle	DKPB-60	025-0774-000	025-0774-001
	Plug	DKPB-59	025-0758-000	025-1195-000

Assembly/Shielded Contacts

Socket

249-1826-000/MIL-C-39029/51
Size 12/RG-179B/U Cable (used in 71C15 layout)

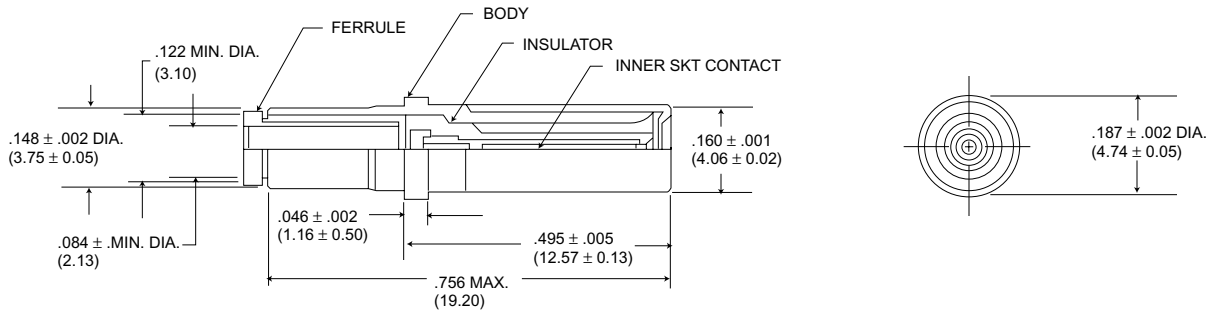

Pin

249-1826-000/MIL-C-39029/50
Size 12/RG-179B/U Cable (used in 71C15 layout)

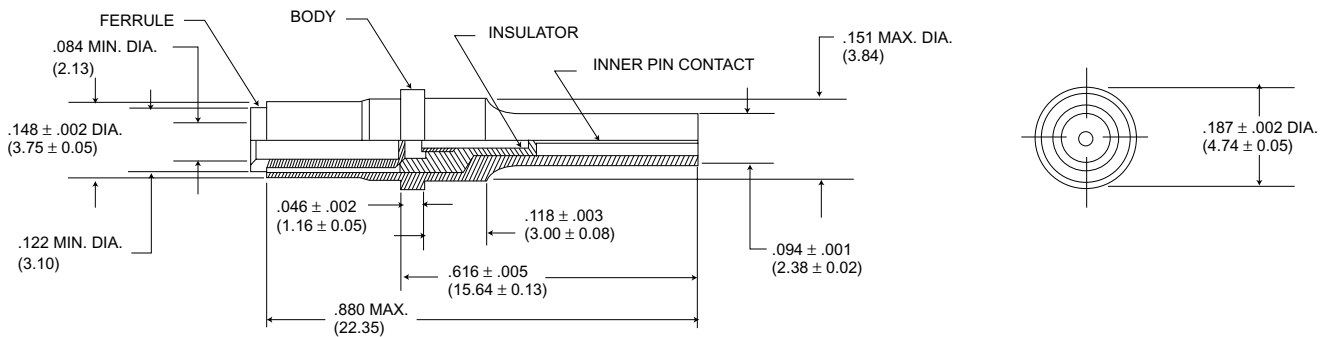

Assembly Instructions

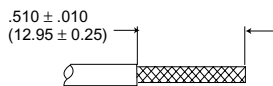

Step 1.
Strip outer jacket to dimensions shown to expose outer conductor.

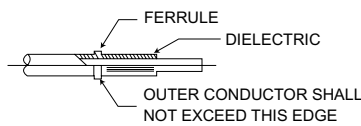

Step 2.
Slip (or install) ferrule over outer conductor against cable jacket. Exposed portion of the outer conductor must be combed out then folded back over ferrule.

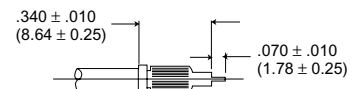

Step 3.
Trim cable to dimensions, as shown. (Ferrule must butt against cable jacket).

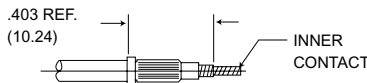

Step 4.
Install inner contact against dielectric then crimp contact and center conductor with a M22520/2-01 crimp tool using a M22520/2-30 locator.

Step 5.
Insert cable, ferrule and inner contact to rear of shell and crimp into place with M22520/5-03 crimp tool.

Coaxial Contact/Assembly

249-5500-010 Socket*
249-5500-011 PIN*

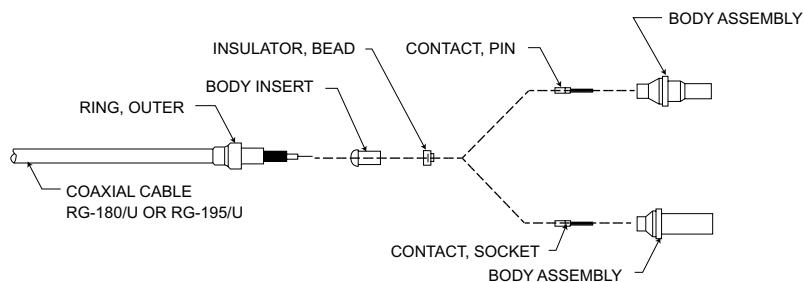

- NOTES:**
1. These assembly instructions apply to 249-5500-010, and 249-5500-011.
 2. The following assembly tools are required:
 - a) CCT-C9 hex crimp tool
 - b) MS3198-Q W/L-3198-C1 contact crimp tool and locator
 - c) 149 C(300 F) hot air gun (recommended): Regal heat Gun No. 9A)
 - d) Blades, scissors, and picks

STEP 1.

Slide outer ring over cable as shown (Figure 1).

STEP 2.

Strip cable as shown (Figure 1).

STEP 3.

Install body insert, insulator bead, and contact on cable as shown (Figure 2.)

STEP 4.

With body insert, insulator bead, and contact firmly in place, crimp the contact with tool M22520/2-01 (setting number 3) and locator M22520/2-30 (Figure 2). Caution: The assembled components must be tightly in place after crimping.

STEP 5.

Slide body assembly over components and under shield until firmly bottomed in place. Locate outer ring over shield and against body as shown (Figure 3).

STEP 6.

With cable and body assembly securely held together, hex crimp the outer ring with tool CCT-C9 (Figure 3). Important: For optimum hex crimp, firmly bottom the outer ring against the shoulder of the hex die before compressing the handles.

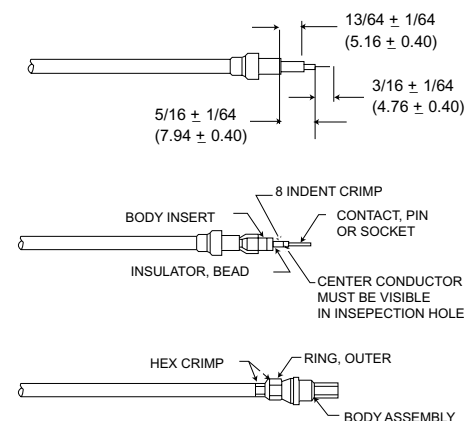

*These contacts are used in the F59C7 layout.

249-5500-012 Socket*
249-5500-013 PIN*

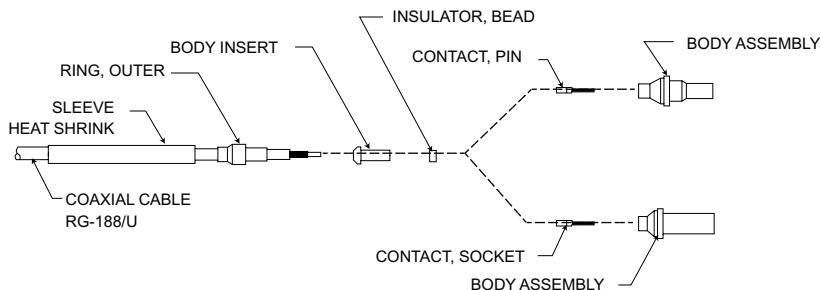

- NOTES:**
1. These assembly instructions apply to 249-5500-010, and 249-5500-011.
 2. The following assembly tools are required:
 - a) CCT-C9 hex crimp tool
 - b) M22520/2-01 contact crimp tool and locator
 - c) 149 C(300 F) hot air gun (recommended): Regal heat Gun No. 9A)
 - d) Blades, scissors, and picks

STEP 1.

Slide heat-shrink sleeve and outer ring over cable as shown.

STEP 2.

Strip cable as shown (Figure 1). Caution: Do not nick shield wires.

STEP 3.

Install body insert, insulator bead, and contact on cable as shown.

STEP 4.

With body insert, insulator bead, and contact firmly in place, crimp the contact with tool M22520/2-01, using setting number 3 and locator M22520/2-30 (Figure 2). Caution: The assembled components must be tightly in place after crimping.

STEP 5.

Slide body assembly over components and under shield until firmly bottomed in place. Locate outer ring over shield and against body as shown (Figure 3).

STEP 6.

With cable and body assembly securely held together, hex crimp the outer ring with tool CCT-C9 (Figure 3). Important: For optimum hex crimp, firmly bottom the outer ring against the shoulder of the hex die before compressing the handles.

STEP 7.

The final step is to shrink the heat sleeve in place with a hot air source of 149 C to 327 C (300 F to 621 F) (Figure 3).

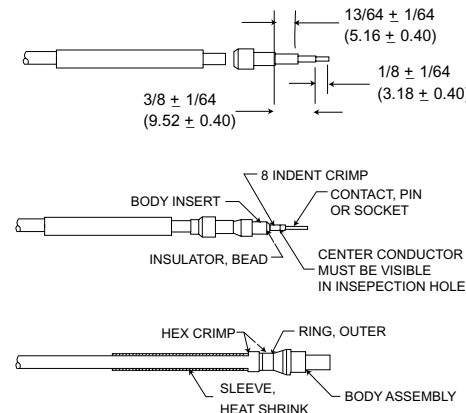

*These contacts are used in the G59C7 layout.



DPA-Miniature Rack/Panel

DPA plugs are rugged, miniature rack/panel plugs utilizing maximum insert space in a one-piece shell. Polarization is accomplished with a keystone cornered shell and the coupling means is friction. Operating temperature for the DPA is - 55 C to + 125 C (-67 F to + 257 F)

DPAF - Float Mount Shells

DPAF plugs are DPA plugs with four rivets with washers on the contact termination side of the connector. Floating rivets are .093 (2.36) I.D. with a minimum of .032 (0.81) float.

DPAL - Large Flange Shells

DPAL plugs are DPA plugs with a large flange.

DPAMA - Little CAESAR' Contact Assembly

DPAMA plugs are DPA plugs with the proven LITTLE CAESAR contact assembly for rear insertion, release and extraction of crimp type contacts. Insertion requires no tool; extraction requires an expendable plastic tool. Hard dielectric, closed-entry socket insert has lead-in chamfers for positive mating of pin contacts. Contacts are of simpler, stronger design for greater resistance to bending or damage and are crimpable with the M22520/1-01 tool.

Material Specifications

		DPA/DPAF/DPAL	DPAMA
Shell	Material	Aluminum alloy	Aluminum alloy
	Finish	Cadmium plate with yellow chromate	Cadmium plate with yellow chromate
Insulator	Material	Melamine	Diallyl phthalate
	Material	Copper alloy	Copper alloy
Contacts	Finish	Gold over copper alloy	Gold over copper alloy
	Termination	Solder pot	Crimp

How to Order

DPA - 24C2 - 34 P
 DPA H - 32 - 34 P -
 DPA MA - 32 - 33 S - *



SERIES PREFIX

CLASS

- F - Float mount shell
- L - Large flange shell
- MA - LITTLE CAESAR contact assembly with crimp, snap in contacts

CONTACT ARRANGEMENT

SHELL TYPE

33 for male, 34 for female

CONTACT TYPE

- P - Pin
- S - Socket

MOUNTING HOLE STYLES

DPA

- No Dash - .093 (2.36) Dia.
- A - .093 (2.36) Dia., countersunk 82 to .173 (4.39) Dia.
- B - .120 (3.05) Dia., countersunk 100 to .225 (5.72) Dia.
- C - .093 (2.36) Dia., countersunk 100 to .182 (4.62) Dia.
- D - .136 (3.45) Dia.
- E - .120 (3.05) Dia.
- F - .100 (2.54) Dia.
- G - .120 (3.05) Dia., countersunk 82 to .203 (5.16) Dia.
- H - Tapped #4-40 NC-2
- J - .093 (2.36) Dia., countersunk 100 to .192 (4.88) Dia.

DPAMA

- No Dash - .093 (2.36) Dia., countersunk 82 to .173 (4.39) Dia.
- A - .093 (2.36) Dia.
- B - .120 (3.05) Dia., countersunk 100 to .225 (5.72) Dia.
- C - .093 (2.36) Dia., countersunk 100 to .182 (4.62) Dia.
- D - .136 (3.45) Dia.
- E - .120 (3.05) Dia.
- F - .100 (2.54) Dia.
- G - .120 (3.05) Dia., countersunk 82 to .203 (5.16) Dia.
- H - Tapped #4-40 NC-2

MODIFIER

Add FO to order connector less contacts. Consult factory for other modifications.

Arrangements with coax contacts, such as 24C2, may be ordered without coax contacts by substituting a "W" for the "C" e.g., DPA-24C2-34P with two coax contacts becomes DPA-24W2-34P with two cavities. The customer can then order separately any snap in coax contact shown on page 95. The customer is thus able to "create" arrangements with infinite combinations of coax contacts.

Solid Shell

DPA-33

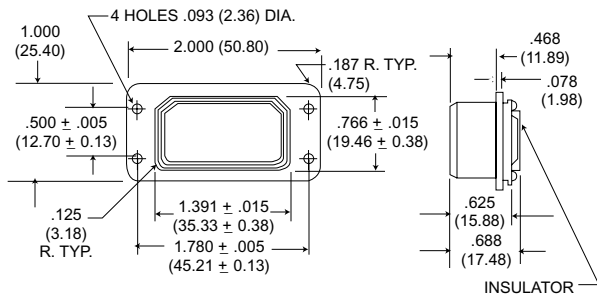

DPA-34

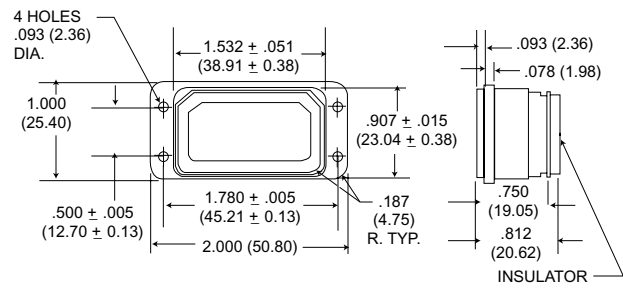

Large Flange Shell

DPAL-33

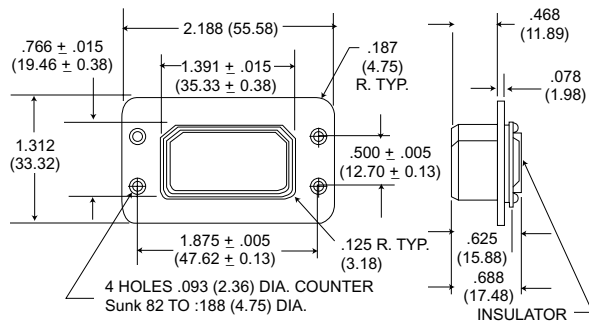

DPAL-34

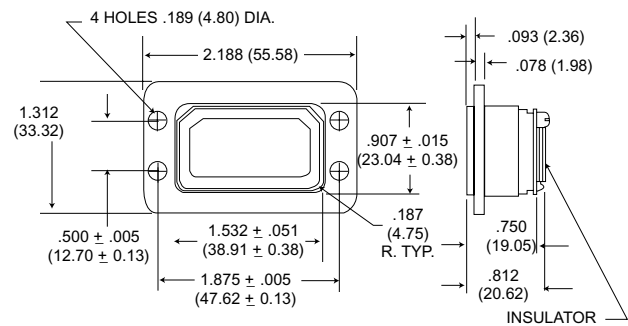

Float Mount Shell

DPAF-33

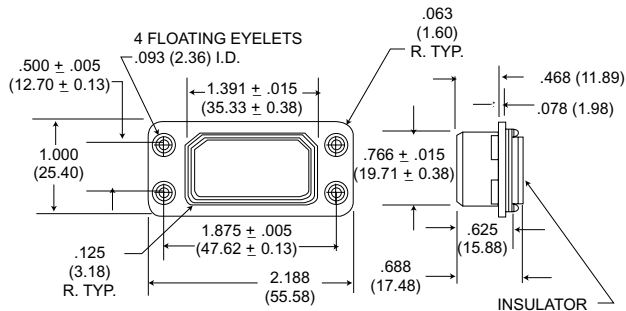

DPAF-34

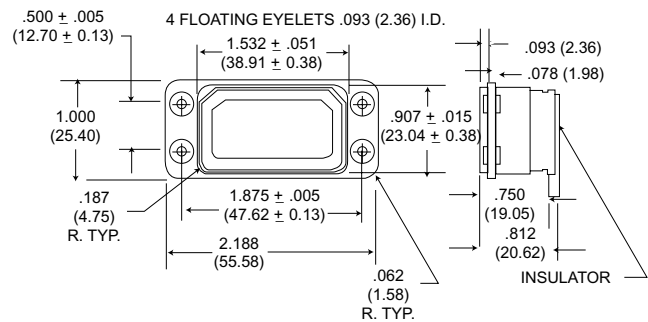

Contact Arrangements

Face view of pin insert

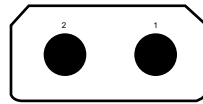

2
2 #4
2900

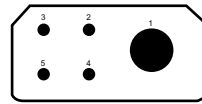

5
1 #4, 4 #14
2500

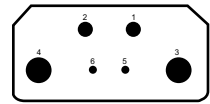

6
2 #8, 2 #12, 2 #20
2600 (5,6)

No. of contacts & Wire Size
Test Voltage AC (RMS)

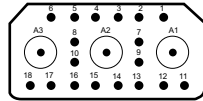

21C3
18 #20, 3 coax
1500 (1-18)
1000 (A1, A2, A3)

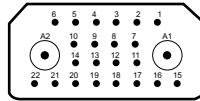

24C2
22 #20, 2 coax
1500 (1-22)
1000 (A1, A2)

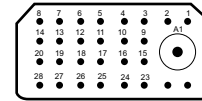

29C1
28 #20, 1 coax
1500 (1-28), 1000 (A1)

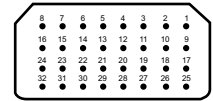

32
32 #20
1500

No. of contacts & Wire Size
Test Voltage AC (RMS)

Arrangement also available with LITTLE CAESAR contact assembly and may be employed in any shell type.

Contact Arrangements

DPA Coaxial Variations

Termination Code	Variations of Basic Arrangements	Coaxial Type/Part Number	Max. Coaxial Extension From Rear of Flange	
			34 Shell	33 Shell
1	A21C3 *24C2 *29C1	FIXED	.953 (24.21)	.453 (11.51)
2	*21C3 D24C2 A29C1	FIXED	.859 (21.82)	.359 (9.12)
3*	B21C3 L24C2 C29C1	P-249-5012-000 S-249-5008-000	1.031 (26.91)	.500 (12.70)
4	C21C3 P24C2 F29C1	FIXED	1.094 (27.79)	.594 (15.09)
5	D21C3 K24C2 K29C1	FIXED	1.047 (26.59)	.561 (14.28)
6*	E21C3 N24C2 L29C1	P-249-5052-002 S-249-5051-001	1.218 (30.94)	.670 (17.02)
7	F21C3 B24C2 M29C1	FIXED	1.094 (27.79)	.594 (15.09)
8	F21C3 C24C2 N29C1	FIXED	1.094 (27.79)	.609 (15.47)
9	H21C3 R24C2 P29C1	FIXED	1.125 (28.98)	.625 (15.88)
10	21HV3 24HV2 29HV1	FIXED	1.062(26.98)	.554 (14.07)
11*	J21C3 H24C2 G29C1	P-249-5052-002 S-249-5051-001	1.218 (30.94)	.670 (17.02)
	21W3 24W2 29W1		Coaxials Not Supplied	

*Termination codes - 3, - 6, - 11 utilize snap - in nonremovable coaxials which are supplied with the connector. These coaxials may be ordered separately when ordering the connectors without coaxials (21W3 24W2 and 29W1 layouts).

DPAMA Coaxial Variations

Variations of Basic Arrangements	Coaxial Type/Part Number	Max. Coaxial Extension From Rear of Flange	
		34 Shell	33 Shell
24W2 29W1	Coaxials Not Supplies*	-	-
E24C2 B29C1	Crimp Type for RG-58/U cable	1.239 (31.47)	.737 (18.72)

*DPAMA coaxials purchased separately may be ordered under the following part numbers: Pin (Plug): 249-1741-000
Socket (receptacle): 249-9008-000
Crimp Tool: CA58073-0000
Extraction tool: CET-C11

NOTE: DPA snap in coaxials and DPAMA crimp coaxials are NOT interchangeable but are intermateable.

Contact Terminations

All dimensions are $\pm .010$ (0.25) unless indicated otherwise.

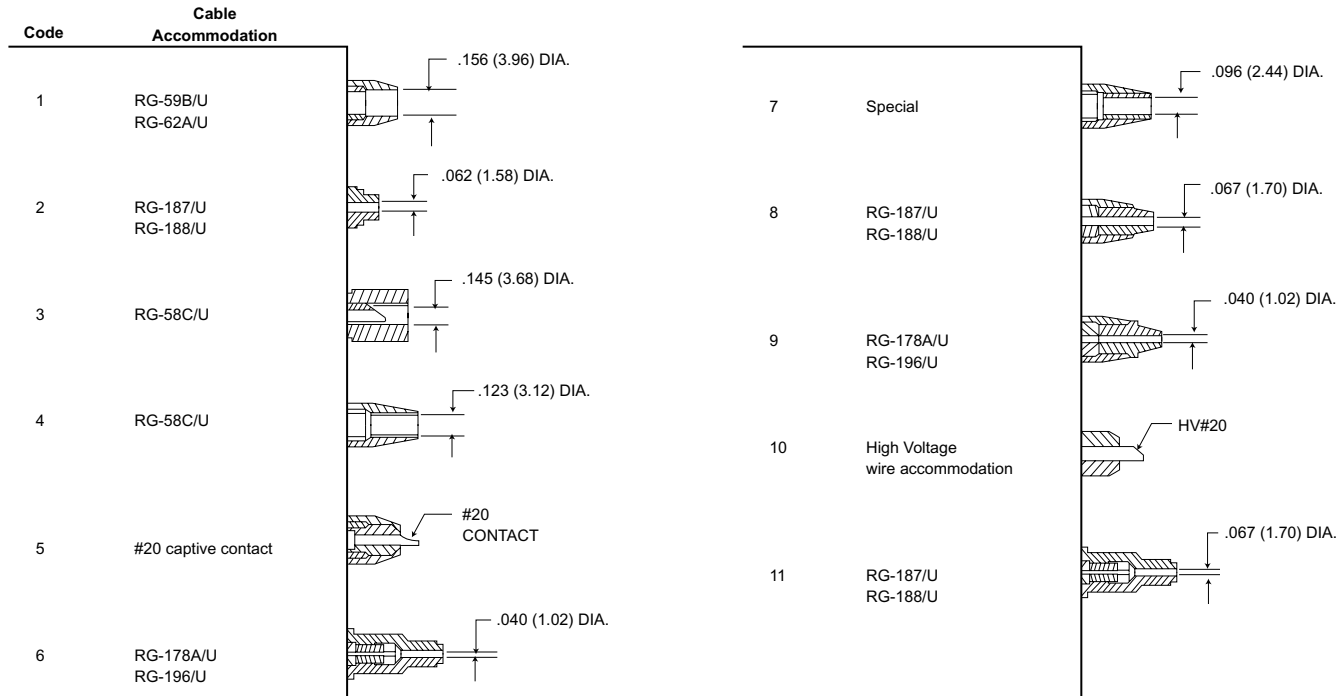

MAX. CONTACT EXTENSION from rear of insulator

Contact Size		20	18	14	12	8	4
Contact	Pin	.156 (3.96)	.140 (3.56)	.125 (3.18)	.218 (5.54)	.218 (5.54)	.250 (6.35)
Extension	Socket	.156 (3.96)	.250 (6.35)	.344 (8.74)	.218 (5.54)	.266 (6.76)	.531 (13.49)

Contact Arrangements

Dust Caps



DPA-59 FOR 33 SHELLS
025-0572-000



DPA-60 FOR 34 SHELLS
025-0573-000

Conductive: DPA-60-1
025-0573-001 (Protects Against Static Electricity)

22054 Potting Shell

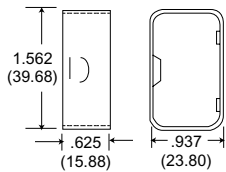

20746 Straight Junction Shell

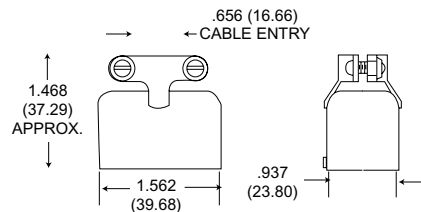

20746-1 90° Angle Junction Shell

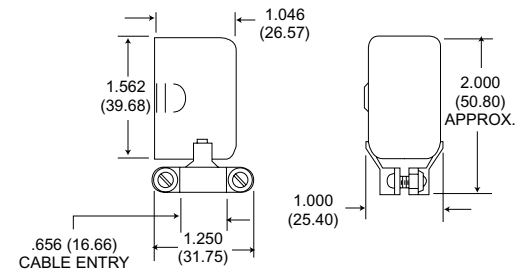

Environmental, Rectangular Connectors for Aircraft, Missile and Ground Support Equipment Applications

Cannon's DPGM, DPJM, and DPJMB connectors are designed for applications where space and weight are prime considerations. Their rectangular shape provides maximum space utilization and permits easy removal of equipment for inspection and/or repair. DPGM and DPJM connectors feature crimp snap-in contacts with ring-type retention while DPJMB connectors feature the LITTLE CAESAR® rear release contact retention assembly (rear insertion, release and extraction of crimp snap-in contacts). They both have one piece diallyl phthalate insulators with polychloroprene wire sealing grommets. They also incorporate a peripheral seal design that allows an axial tolerance of up to .125 (3.175) while still effecting a seal. The 34 shell utilizes a rubber seal encased in such a way that the step down design of the mating 33 shell seats into and against it.

All of these connectors utilize keystone corners for polarization and are coupled by friction. Two shell styles with different mounting provisions are available.



For all new applications, the referenced connectors will be available only with insulators in the normal position, that is, pin insulators in the 34 (receptacle) shells and socket insulators in the 33 (plug) shells.

For replacements it is suggested that where practical, customers using these connectors with reversed insulators change to connectors with insulators in the normal position. However, for those who are unable to change we will furnish connectors with reversed insulators to maintain their equipment usage.

Standard Data

DPGM/DPJM/DPJMB		
Shell	Material	Aluminum alloy
	Finish	Cadmium plate with olive drab irridite
Insulator	Material	Diallyl phthalate
	Material	Copper alloy
Contacts	Finish	Gold plate
	Termination	Crimp
	No. of Contacts	8, 12, 15, 16, 20, 21, 32, 59, 98
Contact Arrangements		

How To Order

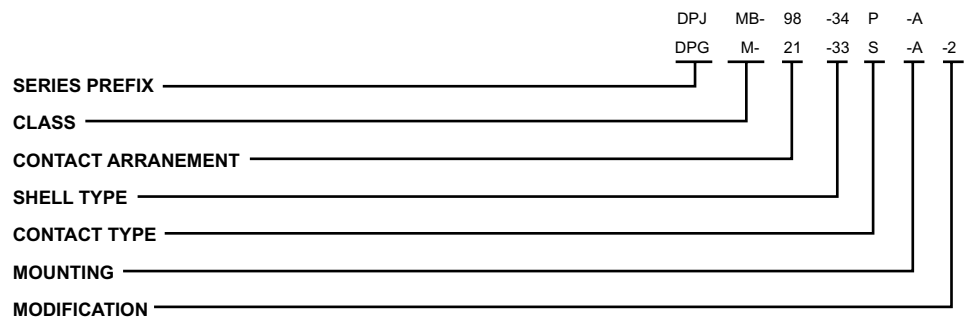

Contacts, coaxials and junction shells must be ordered separately, except for the DPJMB where the contacts are supplied with the connector. When (ordering or reordering) please specify the 3-4-3 contact part number as shown. We have cross-referenced these new part numbers with the previous part numbers (which have been obsoleted) for your convenience.

Example:

031-0900-001 new "3-4-3" part number
 (038819-001) previous part number

SERIES PREFIX

DPG, DPJ

CLASS

M - One piece insulator ring - type retention
 MB - LITTLE CAESAR contact retention assembly

CONTACT ARRANGEMENTS

DPGM - C8, 12, 15, 16, 20C4, 21 and 32
 DPJM - C21, 59, 59C10, and 98
 DPJMB - 59, 98

SHELL TYPE

33 for plug, 34 for receptacle

CONTACT TYPE

P for pin, S for socket

MOUNTING

33-A-With 6-32 captive hex mtg. nuts
 33-B-Clearance holes for 6-32 screw
 34-A-Floating eyelet with 6-32 tapped I.D.
 34-B-Floating eyelet with .140 I.D.

MODIFICATION

-2-.125 (3.18) removed from front lip of -33 shell

Shell Dimensions - DPGM

33 SHELL

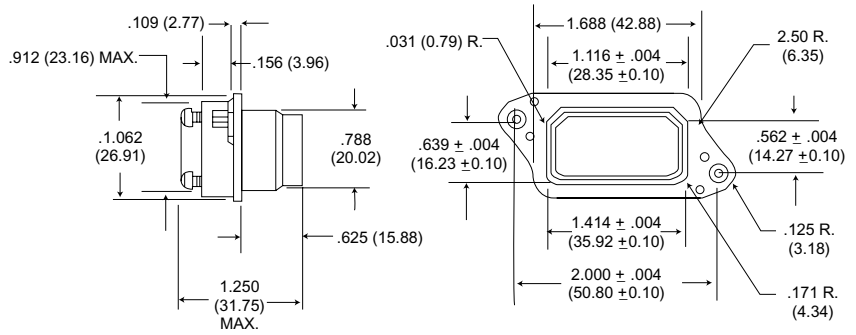

34 SHELL

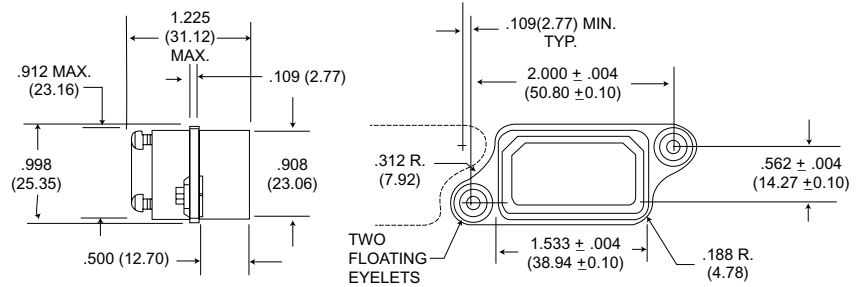

Shell Dimensions - DPJM/DPJMB

33 SHELL

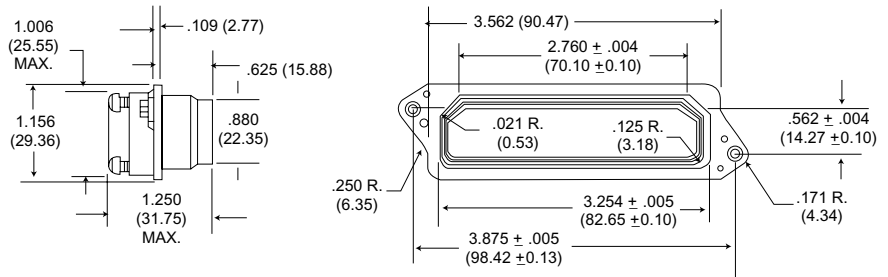

34 SHELL

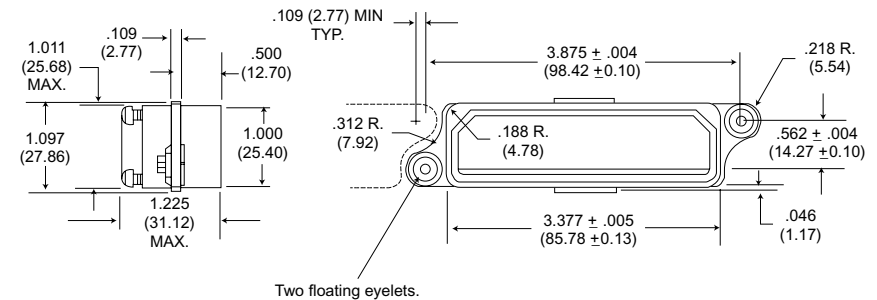

Contact Arrangements

DPGM

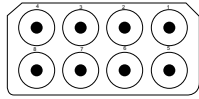

C8*
8 coax (1-8)
1000

No. of Contacts & Wire Size
Test Voltage AC (RMS)

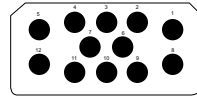

12*
12 #16 (1-12)
See note

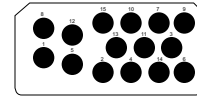

15*
15 #16 (1-15)
See note

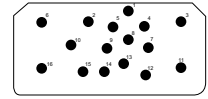

16*
5 #20 (3,6,10,11 & 16)
1500
9 #20 (1,4,5,7-9, 13-15)
1700
(2 #20 (2&12)
1500

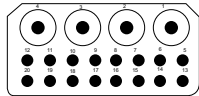

20C4*
16 #20 (5-20)
1500
4 COAX (1-4)
1000

No. of Contacts & Wire Size
Test Voltage AC (RMS)

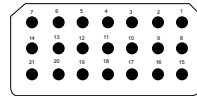

21*
21 #20 (1-21)
1500

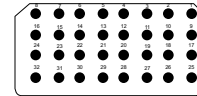

32*
32 #20 (1-32)
1500

*All DPGM arrangements have a 1500 VAC test voltage except for arrangements 12 and 15, which is 3200 VAC for contact 1,5,8 and 12. The remaining contacts have a 2200 VAC test voltage. All coaxials have 1000 VAC rms test voltage.

DPJM/DPJMB

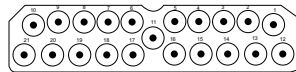

C21*
21 COAX (#1-21)
1000

No. of Contacts & Wire Size
Test Voltage AC (RMS)

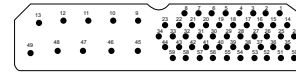

59
49 #20 (1-8,14-44 & 50-59)
1500
10 #12 (9-13 & 45-49)
1500

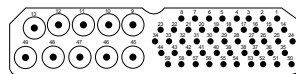

59C10*
49 #20 (1-8, 14-44&50-59)
1700
10 COAX (9-13&45-49)
1000

No. of Contacts & Wire Size
Test Voltage AC (RMS)

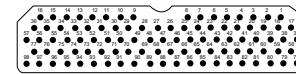

98*†
98 #20 (1-98)
1500

* All DPJM and DPJMB power contact arrangements have a 1500 VAC rms test voltage. Coaxials have 1000 VAC rms voltage.
†* Available with LITTLE CAESAR contact assembly (DPJMB).

Current Carrying Capacity of Wires and Cables	
Wire Size	Amperage
#4	80
#8	46
#12	23
#16	13
#20	7.5

Junction Shells

DPGM

DPGM junction shells are essential for proper installation of connector and are ordered separately.

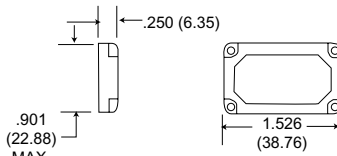

Part No. 248-1711-000
(038989-0000)

Part No. 248-1711-000
(038989-0000)

DPJM/DPJMB

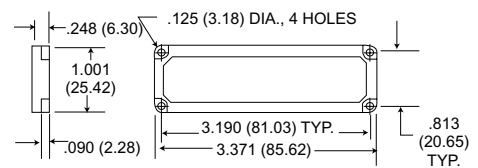

Part No. 248-1710-000
(038988-0000)

Part No. 248-1710-000
(038988-0000)

Wire Bushings

Small wires should be provided with rubber bushings before crimpin. Approximately 1/16 (1.59) of an inch of bushing is visible when installed into grommet. Grommets will seal with out bushings or wire .096 (2.44) to .185 (4.70) to diameter.

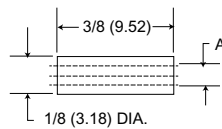

Sealing Wires on #12 and Coaxial Contacts

New Part Number	Existing Part Number	Wire Size O.D.	I.D A
012-0319-000	021604-0002	.040-.083	.062
012-0435-000	021604-0004	.080-.096	.080

Hole Fillers



All holes in grommet require filling either by a wire and contact, or by means of wire hole plugs.

Contact Size	Part Number
20	225-0070-000
16	225-0071-000
12	225-0072-000
Coaxial	225-0085-000

Contact/Coaxial Data and Termination Tool

DPJMB	Contact Size	Wire Size Accom.	Contact Part Number		Crimp Tool Part No.	Locator	Locator Color	Extraction Tool No.
			Pin	Socket				
	20	20-24	030-9081-001	031-9082-001	M22520/1-01	M22520/1-02	red	CET 20-14
	12	12-14	030-9185-002	031-9186-002	M22520/1-01	M22520/1-02	yellow	CET 12-4

DPGM/DPJM	Contact Size	Wire Size Accom.	Contact Part Number		Crimp Tool Part No.	Locator	Locator Color	Extraction Tool No.
			Pin	Socket				
	20	20-24	031-0905-000 (038820-0001)	031-0900-001 (038819-0001)	M22520/1-01	M22520/1-02	CIT 20	CET 20A
	16	16-20	031-0944-000 (040370-0000)	031-0945-000 (040371-0000)	M22520/1-01	M22520/1-02	CIT 16	CET 16
	12	12-14	031-0909-000 (038825-0000)	031-0908-000 (038826-0000)	M22520/1-01	M22520/1-02	CIT 12	CET 12
	20-18	18	031-0907-000 (038820-0000)	031-0906-000 (038819-0002)	M22520/1-01	M22520/1-02	CIT 18	CET 20A

Coaxials	Contact Size	Wire Size Accom.	Contact Part Number		Crimp Tool Part No.	Insertion Tool No.	Extraction Tool No.
			Plug	Receipt			
	COAX	50 ohm (RG 196/U)	249-1178-001 (038834-0001)	249-1177-001 (038833-0001)	M22520/5-01 with Y-193 Die	CIT C2	CET C1
	COAX	75 ohm (RG 1871U)	249-1176-001 (038832-0001)	249-1175-001 (038831-0001)	WT400 995-001-071	CIT C2	CET C1
	COAX	95 ohm (RG 195/U)	249-1174-001 (038830-0001)	249-1173-001 (038829-0001)	WT402 HX3-138	CIT C2	CET C1
	COAX	150 ohm	249-1172-001 (038828-0001)	249-1171-001 (038827-0001)	WT408	CIT C2	CET C1

Assembly Procedures

Wiring and Crimping Contacts

Wires should be stripped to the dimension appropriate to the contact use

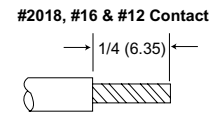
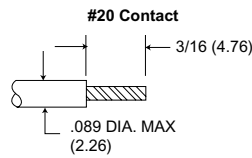

1. CONTACT INTO CRIMP TOOL

Drop contact into crimp tool, it will locate on the contact shoulder.

2. WIRE INTO CONTACT

Take wire stripped to dimensions above, and push into the contact crimp pot until it is completely home. Where outside diameter of wire in the #12 or COAXIAL contact is less than .096 (2.44), a rubber bushing must be slipped over the wire before crimping (see page 99).

3. CRIMP

Squeeze the crimp tool to secure the wire into the contact. It is not possible to remove the contact from the crimp tool until crimp is completed.

4. REMOVED WIRED CONTACT FROM TOOL

5. INSPECT

If wires are stripped and crimped correctly, the wire will be visible through the small inspection hole in the contact.

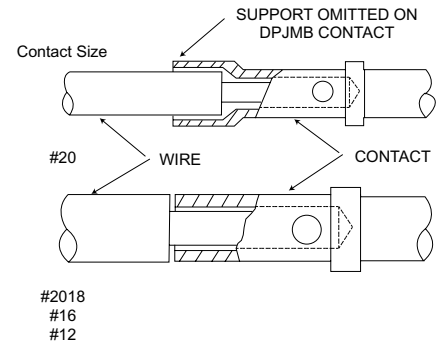

Contact Insertion (DPGM/DPJM)

Inserting #20 & #16 Contacts



Inserting Coaxial & #12 Contacts



After the contacts have been crimped, they should be threaded through the junction shell and inserted with the tools shown below. It is recommended that the contacts be inserted in the center horizontal row first, then work to the top and bottom horizontal rows.

Contact	Tool Description	Assembly Number
#20	CIT - 20	038894-0000
#16	CIT - 16	038895-0000
#12	CIT - 12	038896-0000
Coaxial 50-75,95 & 150 ohm	CIT - C2	038901-0000

Contact Extraction (DPGM/DPJM)

Extracting #20 & #16 Contacts



Extracting Coaxial & #12 Contacts



If it is necessary at any time to remove contacts, this may be accomplished with an impact extraction tool. Simply place the correct tool on the engaging end of the contact and push. A reversible tip is provided for pins and sockets.

Contact	Tool Description	Assembly Number
#20	CET - 20A	038889-0100
#16	CET - 16	038888-0000
#12	CET - 12	038890-0000
Coaxial 50-75,95 & 150 ohm	CET - C1	038869-0000

Assembly Procedures

Coaxial Contact Assembly (DPGM/DPJM)

Cable Stripping

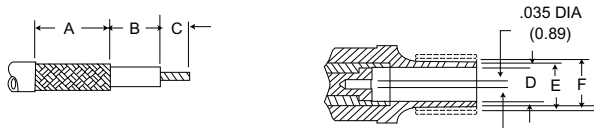

	Cable Trim Dimensions			Cable Entry Dimensions		
	A	B	C	D min. dia.	E max. dia.	F min. dia.
150 ohm	3/16 (4.76)	1/16 (1.59)	5/32 (3.97)	.154 (3.91)	.183 (4.65)	.202 (5.13)
95 ohm	3/16 (4.76)	1/8 (3.18)	5/64 (1.98)	.106 (2.69)	.139 (3.53)	.153 (3.89)
75 ohm	3/16 (4.76)	1/8 (3.18)	5/64 (1.98)	.122 (3.10)	.158 (4.01)	
50 ohm	1/4 (6.35)	1/8 (3.18)	5/64 (1.98)	.106 (2.69)	.136 (3.53)	

50 Ohm Contact (RG-196U)
(assembly steps 1, 2, 3, 4, 5 & 8)

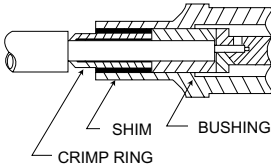

75 Ohm Contact (RG-187U)
(assembly steps 1, 2, 3, 5 & 8)

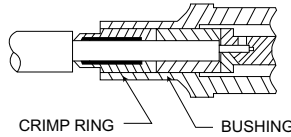

95 Ohm Contact (RG-195U)
(assembly steps 1, 3, 6, 7 & 8)

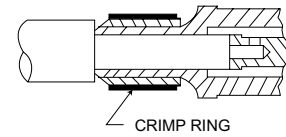

Assembly Steps

- After the coaxial cable has been stripped to the proper dimensions, tin the center conductor. If O.D. of cable is less than .096 (2.44), slip rubber bushing over wire. (50, 75 & 95 ohm)
- Assemble crimp ring under braid and add bushing to cable. (50 & 75 ohm)

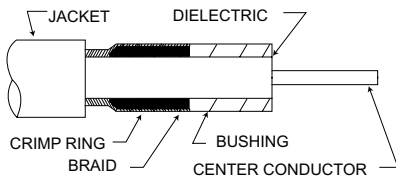

- The center contact is supplied loose in the polyethylene bag. Insert the tinned conductor into the contact. Wire must be visible through inspection hole and dielectric pushed against contact shoulder. For 150 ohm contact shoulder must be flush against bushing. Heat contact with a clean soldering iron. Avoid solder outside contact, (50, 75, & 95 ohm)

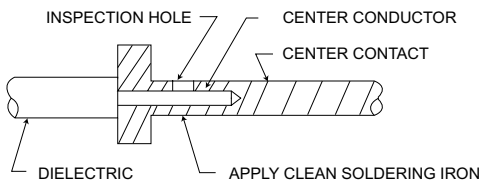

- Wrap shim around braid. (50 ohm)

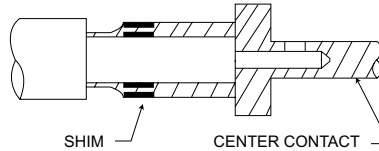

- Feed cable and assembled parts into coaxial shell. Care is required if braid is to fit smoothly inside the shell. (50 & 75 ohm)
- Thread crimp ring over cable. Feed center contact into coaxial shell with the shell between the dielectric and the braid. (95 ohm)

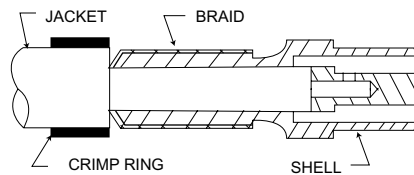

- Slip crimp over the braid. (95 ohm)
- Crimp - crimp tool must be located 1/16 (1.58) to 5/64 (1.98) from shoulder of coaxial. (50, 75 & 95 ohms)

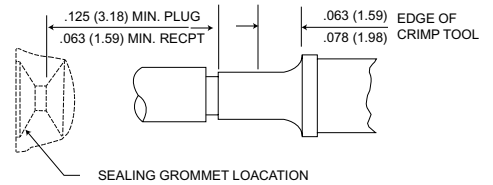

Junction Shell, Assembly of



Slip junction shell over grommet and secure with four screws and lock washers.

Panel Cutouts

33 and 34 Shell Styles

DPGM

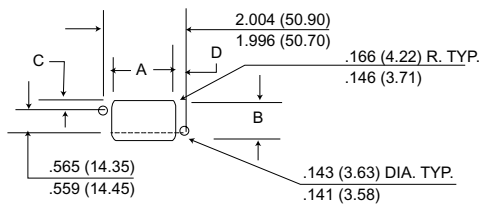

DPJM DPJMB

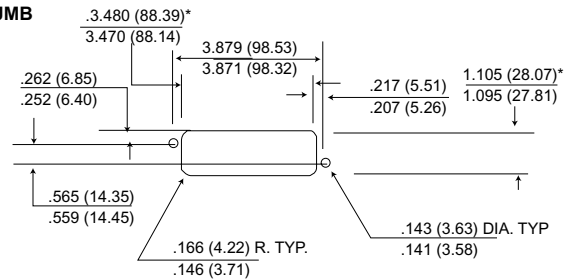

*These dimensions allow for float mounting.

	A	B	C	D	Gap Between Flanges after mating
DPGM-33	1.609(40.87)	.985(25.02)	.214(5.44)	.203(5.16)	.500(12.70)
	1.599(40.61)	.975(24.76)	.204(5.18)	.193(4.90)	.625(15.88)
DPG-34	1.636(41.55)	1.011(25.68)	.227(5.76)	.190(4.83)	.500(12.70)
	1.626(41.30)	1.001(25.42)	.217(5.51)	.180(4.57)	.625(15.88)

PANEL THICKNESS: Maximum sum of both panel thicknesses is 7/16 of an inch when 33 plug and 34 receptacle are back mounted. Shell style 33 modifications A and -2 can be back mounted ONLY. Shell style 33 modifications B and shell style 34 modifications B and H may be front or back mounted. Consult factory for additional information.

Mounting Variations

33 Shell

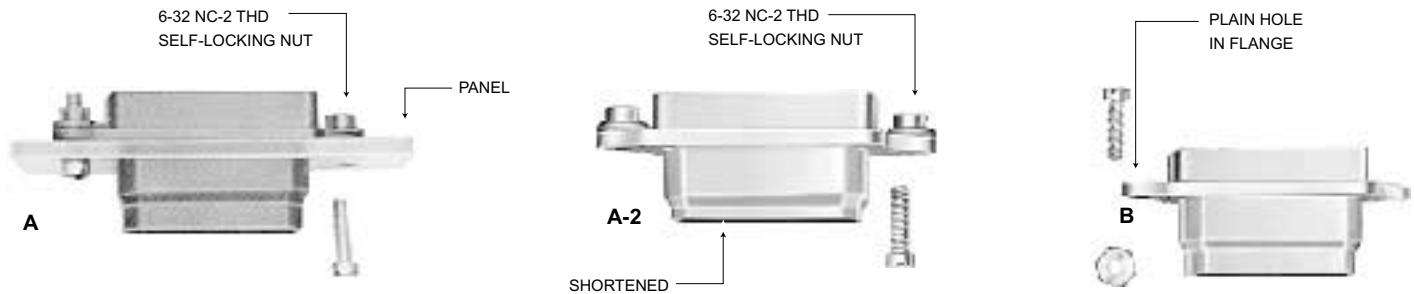

34 Shell

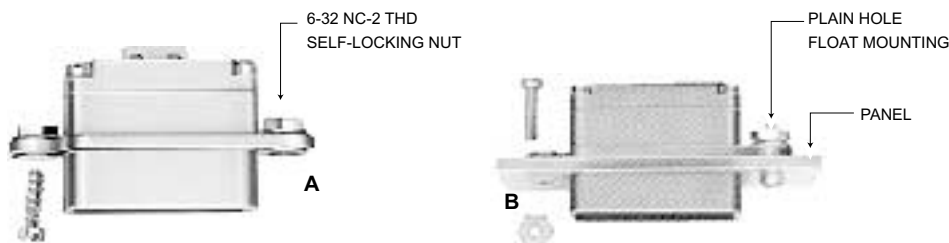

- Rectangular Rack/Panel Connectors
- Non-Environmental Single and Two-Gang Configurations

Cannon's DPD Rack and Panel connectors are distinguished from other connector lines by their rectangular shape which provides maximum space utilization in a rack or chassis mounted equipment. The DPD is used in any commercial application where moisture/ environmental resistance is not required, such as I/O connector or computer panels, GFE test equipment, and GSE ground support equipment. For example, one-half of a connector assembly is mounted on a radio rack, or panel, and the mating connector is attached to a cable that

connects to another instrument or rack. The DPO has a temperature range of -55°C to +125°C (-67°F to +257°F). In addition to standard DPD connectors with solder contacts, the DPDMA version has rear insertion, rear release crimp, snap-in contacts that feature the LITTLE CAESAR®, rear. release contact retention assembly used in many other ITT Cannon product lines.



DPD-33/DPDMA-33
Plug



DPD-34/DPDMA-34
Receptacle



DPD2-33/DPD2MA-33
Plug



DPD2-34/DPD2MA-34
Receptacle

DPD - Standard Rack and Panel Connector Series

DPD connectors are the original rectangular rack and panel connectors with solder type contact termination, accommodating a wide range of contact arrangements and a variety of endbells and junction shells.

DPDMA - LITTLE CAESAR® Contact Assembly

DPDMA connectors are DPD's with the LITTLE CAESAR contact assembly for rear insertion, release and extraction of crimp type contacts. Contacts are inserted by hand, and extraction is accomplished with the use of an expendable plastic

tool. Hard dielectric, closed-entry socket inserts have lead-in chamfers for positive mating of pin contacts during engagement. Both the DPD and DPDMA connectors are intermateable.

DPD2 - Two Gang Version of DPD

DPD2 connectors are two-gang versions of the DPD solder type connectors designed to handle double the circuitry in instrument panel disconnect applications. The DPD2 is identical in shell style and materials to the DPD, but features a center coupling screw for positive engagement. Various coupling devices are shown on pages 110 and 111. The DPD2 may also be ordered without the engaging device by

omitting the letter code "M" as shown in the ordering nomenclature. Two optional polarizing posts give up to six alternate insert positions (page 112).

DPD2MA - LITTLE CAESAR® Contact Assembly

DPD2MA connectors are DPD2 connectors with the LITTLE CAESAR contact assembly for rear insertion, release and extraction of crimp type contacts. Contact insertion is by hand and extraction is by an expendable plastic tool. Hard dielectric, closed-entry socket inserts have lead-in chamfers for positive mating of pin contacts during engagement. DPD2 and DPD2MA connectors are intermateable.

Performance and Material Specifications

MATERIALS AND FINISHES

		DPD/DPD2	DPDMA/DPD2MA	DPD/DPDMA Specifications
Shell/Polarization Hardware	Material	Aluminum alloy	Aluminum alloy	QQ-A-591/A380
	Finish	Natural cadmium plate	Natural cadmium plate	QQ-P-416
Insulator	Material	Melamine or fabricated phenolic	Diallyl phthalate	MIL-M-14
	Material	Copper alloy	Copper alloy	QQ-C-533
Contacts	Finish	Silver or gold plate*	Silver or gold plate*	QQ-C-365 MIL-G-45204
	Termination	Solder pot	Crimp	N/A

*Size 20 contacts have gold plate finish. All other sizes have silver plate finish. Tin alloy may be substituted for silver.

VOLTAGE/CURRENT DATA

Insert Voltages/Test Results

There was no evidence of breakdown when the test voltages given were applied, for a period of one minute, between the contacts and between the shell and the contacts with spacings as noted.

Laboratory Conditions

Ambient Temperature	23°C to 27°C (73°F to 80.6°F)
Relative Humidity	69% to 73%
Barometric Pressure	29.70 (754.38) to 29.75 (755.65)

Current Carrying Capacity of Wire and Cables

Wire Size	#4	#6	#8	#10	#14	#16	#20
Amperage	100	80	60	35	25	20	7.5

Contact Clearance	Test Voltage 60 cps (ac rms)	Contact Clearance	Test Voltage 60 cps (ac rms)
1/64 (0.40)	540 Volts	3/16 (4.76)	3650 Volts
1/32 (0.79)	1000 Volts	13/64 (5.16)	3850 Volts
3/64 (1.19)	1300 Volts	7/32 (5.56)	4050 Volts
1/16 (0.59)	1700 Volts	15/64 (5.95)	4240 Volts
5/64 (1.98)	2050 Volts	1/4 (6.35)	4420 Volts
3/32 (2.38)	2350 Volts	19/64 (7.54)	4940 Volts
7/64 (2.78)	2600 Volts	5/16 (7.94)	5100 Volts
1/8 (3.18)	2900 Volts	3/8 (9.52)	5750 Volts
9/64 (3.57)	3050 Volts	25/64 (9.92)	5890 Volts
5/32 (3.97)	3250 Volts	13/32 (11.03)	6020 Volts
11/64 (4.37)	3450 Volts	7/16 (11.11)	6300 Volts
		1/2 (12.70)	6800 Volts

How to Order

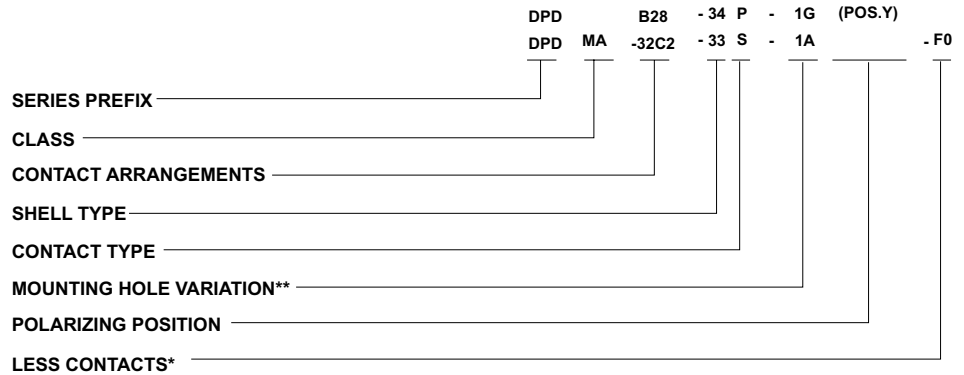

SERIES PREFIX
DPD - ITT Cannon Prefix

CLASS
Blank - Solder contacts
MA - Crimp type contacts in LITTLE CAESAR contact assembly

CONTACT ARRANGEMENTS
See page 106 (solder termination), page 107 (crimp termination)

SHELL TYPE
33 for plug, 34 for receptacle

CONTACT TYPE
P - Pin
S - Socket

MOUNTING HOLE VARIATION
1A - .144 (3.66) dia., for #6 flathead screw
1B - .144 (3.66) dia., 100° countersunk for #6 flathead screw
1G - .152 (3.86) dia., 82° C countersunk for #6 flathead screw
1L - .144 (3.66) dia., 82° countersunk for #6 flathead screw

POLARIZING POSITION
N,V,W,X,Y,Z (See page 112)

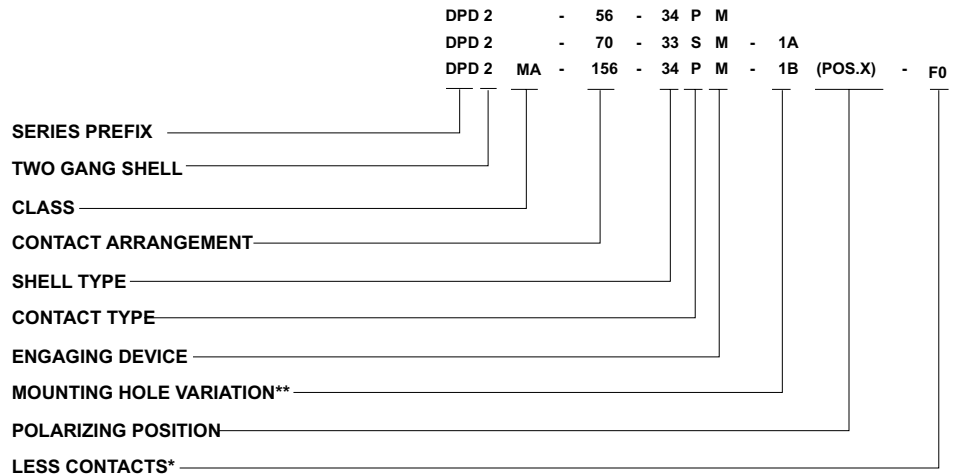

SERIES PREFIX
DPD - ITT Cannon Prefix

TWO-GANG SHELL
2 - Two-gang shell

CLASS
Blank - Solder contacts
MA - Crimp type contacts in LITTLE CAESAR contact assembly

CONTACT ARRANGEMENTS
See page 106 (solder termination), page 107 (crimp termination)

SHELL TYPE
33 for plug, 34 for receptacle

CONTACT TYPE
P - Pin
S - Socket

ENGAGING DEVICE
For devices available, see pages 110 and 111

MOUNTING HOLE VARIATION**
1A - .144 (3.66) dia., for #6 cap screw
1B - .144 (3.66) dia., 100° countersunk for #6 flathead screw
1G - .152 (3.86) dia., 82° C conutersunk for #6 f lathead screw

POLARIZING POSTION
N,V,W,X,Y,Z (See page 112)

*DPDMA/DPD2MA only

**Omit code for standard .144 (3.66) dia. mounting hole 82° countersunk for #6 flathead screw.

Single Gang

33 Plug

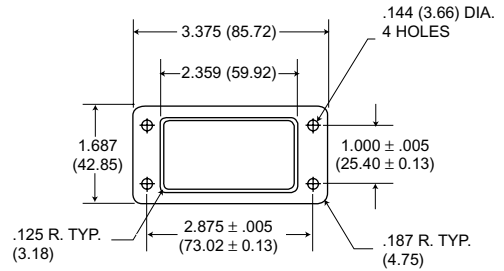
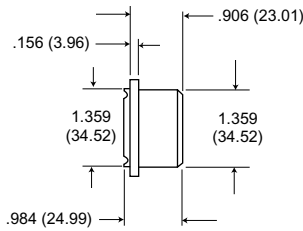

For mounting hole variations, see page 104

33 Receptacle

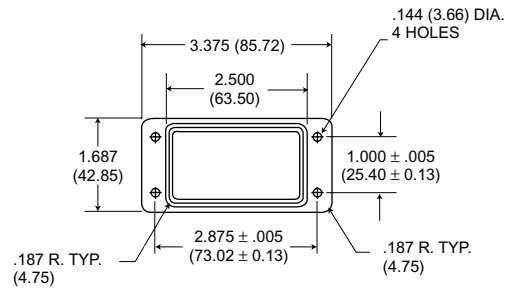
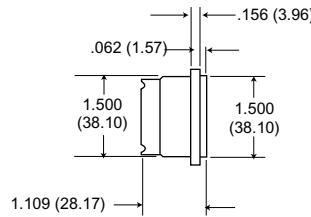

For mounting hole variations, see page 104

Two Gang

33 Plug

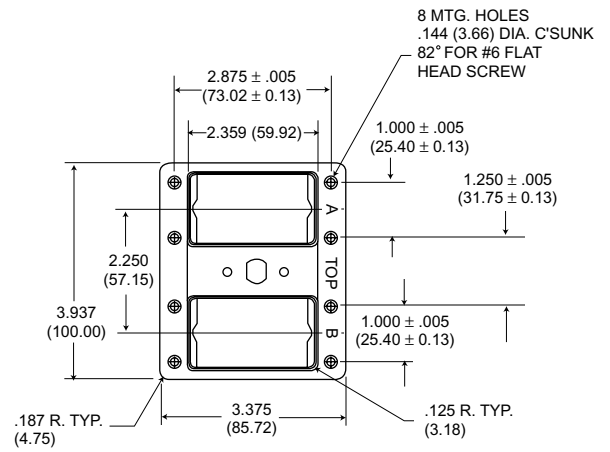
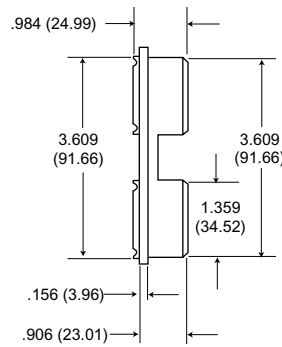

For headscrew variations, see page 111

34 Receptacle

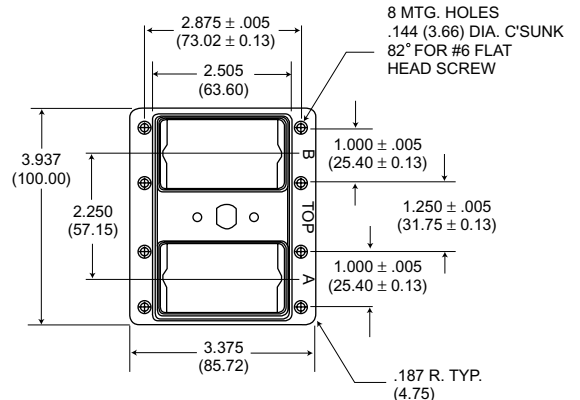
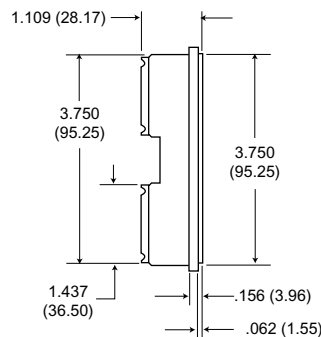

For headscrew variations, see page 111

Contact Arrangements - DPD Solder

Face view of pin insert
Illustrations are not actual size

See page 103 for test voltage

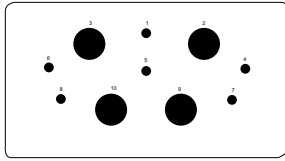

MOLDED N10
TOTAL CONTACTS:10
2-#16(#1,5) CLEARANCE 5/32 (3.97)
4-#16(#4,6,7,8) 9/64 (3.57)
4-#4(#2,3,9,10) 9/64 (3.57)

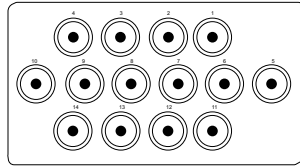

MOLDED AJ14 for crimp AN14 for solder
TOTAL CONTACTS:14
14 min. coax. (#1-14) CLEARANCE 1/16 (1.59)

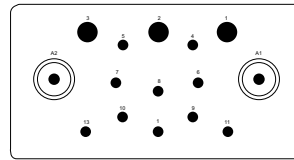

MOLDED 15C2
TOTAL CONTACTS:15
2-#14 (#4,5) CLEARANCE 3/16 (4.76)
2-#14 (#6,7) 7/32 (5.56)
2-#14 (#9,10) 1/4 (6.35)
1-#14 (#8) 9/32 (7.14)
3-#14 (#11-13) 13/64 (5.16)
3-#10 (#1-3) 11/64 (4.37)
2-coax. (A1,A2) grounded

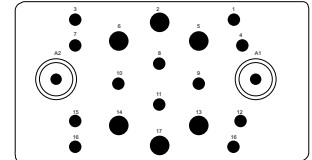

MOLDED B20C2
TOTAL CONTACTS:20
8-#16 (#1,3,4,7,12,15,16,18) CLEARANCE 3/64 (1.19)
2-#16 (#8,11) 11/64 (4.37)
2-#16 (#9,10) 5/32 (3.97)
6-#14 (#2,5,6,13,14,17) 5/32 (3.97)
2-coax. (A1,A2) grounded

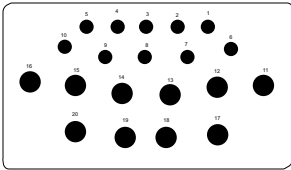

MOLDED G20
TOTAL CONTACTS:20
3-#14(#7,9) CLEARANCE 5/64 (1.98)
7-#14(#1-6,10) 1/16 (1.59)
2-#10(#18,19) 1/16 (1.59)
8-#8(#11-17,20) 1/16 (1.59)

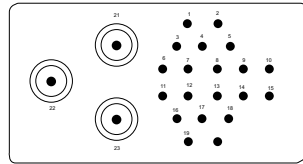

MOLDED 23C3
TOTAL CONTACTS:23
20-#16(#1-20) CLEARANCE 1/16 (1.59)
3-coax.(#21-23) grounded

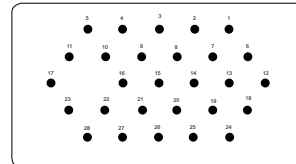

MOLDED B28
TOTAL CONTACTS:28
28-#16(#1-28) CLEARANCE 7/64 (2.78)

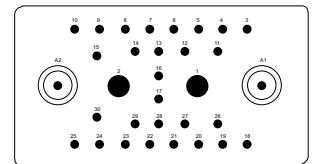

MOLDED 32C2
TOTAL CONTACTS:32
28-#16(#3-30) CLEARANCE 3/64 (1.19)
2-#8(#1,2) (.156 Dia.) 3/64 (1.19)
2-coax. (A1, A2) grounded

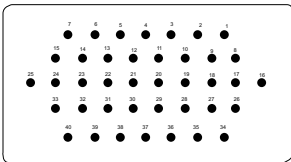

FABRICATED 40
TOTAL CONTACTS:40
40-#16(#1-40) CLEARANCE 1/16 (1.59)

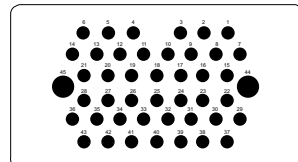

MOLDED 45
TOTAL CONTACTS:45
43-#16(#1-43) CLEARANCE 3/16 (1.19)
2-#10(#44, 45) 3/64 (1.19)

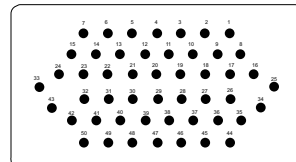

MOLDED 50
TOTAL CONTACTS:50
50-#16(#1-50) CLEARANCE 1/16 (1.59)

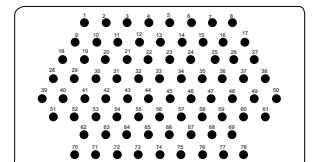

MOLDED 78
TOTAL CONTACTS:78
78-#16(#1-78) CLEARANCE 1/32 (0.79)

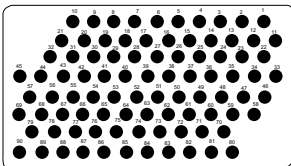

MOLDED 90
TOTAL CONTACTS:90
90-#16(#1-90) CLEARANCE 1/32 (0.79)

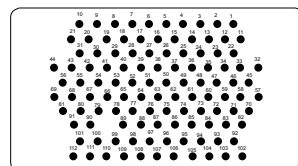

FABRICATED 112
TOTAL CONTACTS:112
112-#20(#1-112) CLEARANCE 3/64 (1.19)

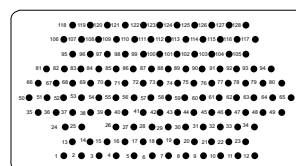

FABRICATED 128
TOTAL CONTACTS:128
128-#20(#1-128) CLEARANCE 3/64 (1.19)

Contact Arrangements - DPDMA Crimp

Face view of pin insert
Illustrations are not actual size

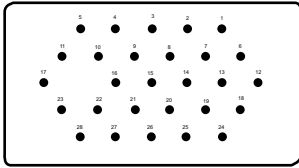

MOLDED B28
TOTAL CONTACTS:28
28-#16(#1-28) CLEARANCE 7/64 (2.78)

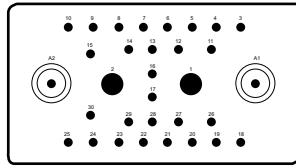

MOLDED 32C2*
TOTAL CONTACTS:32
28-#16(#3-30) CLEARANCE 3/64 (1.19)
2-#8(#1,2) (.156 Dia.) 3/64 (1.19)
2-coax. (A1, A2) grounded

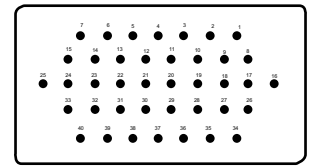

MOLDED 40
TOTAL CONTACTS:40
40-#16(#1-40) CLEARANCE 1/16 (1.59)

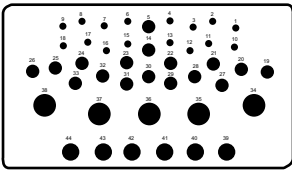

MOLDED A44
TOTAL CONTACTS:44
16-#20(1-4, 5-13, 15-18) CLEARANCE 3/64 (1.19)
17-#16(5,14,19-33) 3/64 (1.19)
6-#12(39-44) 3/64 (1.19)
5-#8(34-38)(.142 Dia.) 3/64 (1.19)

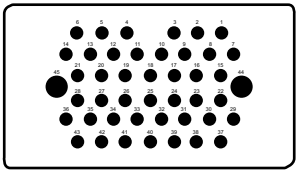

MOLDED 45
TOTAL CONTACTS:45
43-#16(#1-43) CLEARANCE 3/64 (1.19)
2-#10(#44, 45) 3/64 (1.19)

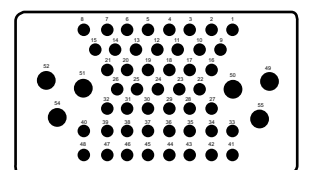

MOLDED F54
TOTAL CONTACTS:54
48-#16(#1-48) CLEARANCE 1/32 (0.79)
6-#12(49-54) 1/16 (1.59)

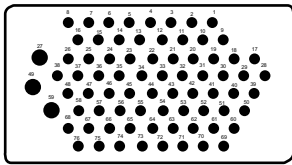

MOLDED 76
TOTAL CONTACTS:76
73-#20(1-26,28-48, 50-58,60-76) CLEARANCE 5/64 (1.98)
3-#16(27,49,59)

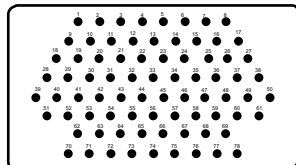

MOLDED 78
TOTAL CONTACTS:78
78-#16(#1-78) CLEARANCE 1/32 (0.79)

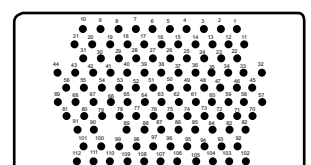

FABRICATED 112
TOTAL CONTACTS:112
112-#20(#1-112) CLEARANCE 3/64 (1.19)

*32C2 arrangement may be purchased less coaxial contacts as -30. All contact variations shown for 32C2 may be purchased in the DPDMA.

DPD2/DPD2MA

DPD2 Insert assemblies consist of two standard DPD insert mounted in a DPD2 shell. They are identified as insert "A" and insert "B". Any two inserts with similar contact arrangements can be used together.

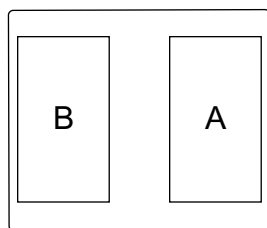

DPD2/DPD2MA Insert Designations
(face view - 34 shell)

The tabulation lists the DPD2 contact arrangement ordering number for the the combination of two inserts. For complete information on each insert, see page 109. Consult factory for combination layouts not shown.

DPD2 Arr. No	Side A	Side B
N20	N10	N10
G48	G20	B28
B56	B28	B28
64	32	32
64C4	32C2	32C2
B68	40	B28
77	45	32
78	50	28
80	40	40
90	45	45
B98C2	B20C2	78
G98	78	G20

DPD2 Arr. No	Side A	Side B
H98C2	H20C2	78
100	50	50
A110	32	78
123	45	78
A123	78	45
152	76	76
156	78	78
180	90	90
190	78	112
224	112	112
256	128	128

Contact Data

Coaxial

Type	Part Number	Description	Cable	Layout/Usage
Pin	249-0365-000	Plug, Straight	RG-7/U	
Socket	249-0366-000	Receptacle, Straight		
Pin	249-0399-000	Plug, Straight	RG-59/U	
Socket	249-0398-000	Receptacle, Straight		
Pin	249-0409-000	Plug, 90° Short	RG-58/U	15C2 B20C2
Socket	249-0410-000	Receptacle, 90° Short		
Pin	249-0228-000	Plug, 90° Long	RG-7/U	23C2 32C2
Socket	249-0226-000	Receptacle, 90° Long		
Pin	249-0229-000	Plug, 90° Short	RG-195/U	
Socket	249-0227-000	Receptacle, 90° Short		
Pin	249-1365-000	Plug, Solder	RG-59/U	AN14
Socket	249-1357-000	Receptacle, Solder		
Pin	249-1333-000	Plug, Solder	RG-62/U	
Socket	249-1332-000	Receptacle, Solder		
Pin	249-1264-000	Plug, Crimp	RG-59/U	AJ14
Socket	249-1265-000	Receptacle, Crimp		

Crimp

Contact Size	Type	Part Number	Wire Size	Max. Wire Insul O.D	Crimp Tool Part Number	Locator	Extraction Tool Part Number	Layout/Usage
20	Pin	030-9081-000	20-24	.084 (2.13)	M22520/1-01	M22520/1-02	CET 20-8	76.112, A44
	Socket	031-9134-001						
16-20	Pin	030-9123-000	20-24	.084 (2.13)	M22520/1-01	Blue	CET 16-9 CET 16-15	B28, 32C2, 40, A44, F54, 45, 76 78
	Socket	031-9203-002						
16	Pin	030-9083-000	16-20	.110 (2.79)	M22520/1-01	Blue	CET 16-9 CET 16-15	
	Socket	031-9206-003						
12	Pin	030-1909-000	12-16	.150 (3.81)	M22520/1-01	Yellow	CET 12-4	A44 F54
	Socket	031-1059-000						
30A (#10)	Pin	030-1757-000	10-12	.206 (5.23)	Solder Pot Type Only		CET 10-1	45
40A (#8)	Socket	030-1758-000						
8	Pin	030-9175-000	8-10	.250 (6.35)	CBT-600B CCH-8-1 CCHP-8-6	-	CET 8-2	32C2 A44
	Socket	030-9176-000						
8	Pin	030-1908-000	8-10	.250 (6.35)				
	Socket	030-9201-003						

R Coaxial

R Coaxial Contact Rating
 Contact Rating: 10 amps
 Cable Size: RG-7/U .250 (6.35) I.D.
 Test Voltage: 1000 rms AC



Pin: 249-0365-000
 Socket: 249-0366-000

R Coaxial 90° (long) Contact Rating
 Contact Rating: 10 amps
 Cable Size: RG-7/U
 Test Voltage: 1000 rms AC



Pin: 249-0228-000
 Socket: 249-0226-000

R Coaxial 90° (short) Contact Rating
 Contact Rating: 10 amps
 Cable Size: RG-7/U
 Test Voltage: 1000 rms AC



Pin: 249-0229-000
 Socket: 249-0227-000

HV CONTACT
 Contact Rating: 10 amps
 Wire Size: #16
 Test Voltage: 7500 rms AC



Hi Voltage contacts fit the coaxial cavities. Must be disassembled in order to be soldered.

R COAXIAL

Contact Rating 10 amps

Coaxial Cable Size	X Cable Entry
RG-58/U	.127 (3.23)
RG-59/U	.157 (3.99)
RG-62/U	.157 (3.99)

Test Voltage 1000 rms AC

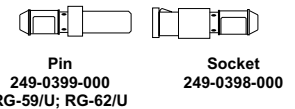

R COAXIAL ADAPTER

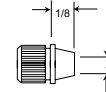

The adapter is shown for reference only. It is furnished as part of the complete coaxial contact Assy.

R Coaxial 90° (short) Contact Rating

Contact Rating 10 amps

Coaxial Cable Size	X Cable Entry
RG-58/U	.125 (3.18)

Test Voltage 1300 rms AC

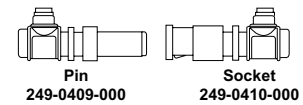

R COAXIAL ADAPTER

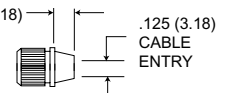

REMOVABLES

Converts R Coaxial Cavity to hold #16, 14 and 8 amps contact.

Contact Ratings	10 15 and 40 amps
Wire Size	16, 14 and 8



Contact Variations

The contact variations shown are modifications of the basic arrangement. For variations not shown please consult factory.

Arr. No.	Basic Arr.	No. of Contacts (Wire Size)					Coax	Spl.	Notes/Modifications
		20	16	14	10	8			
V14	T14						14	Supplied less coaxial contacts (see pg.108 for avail.)	
20	32C2		18			2		#5, 7, 9, 12-17, 29, A1, A2 are open	
B20C2	B20C2		12	6			2	Basic arr. str. coax RG-7/U, P249-0365-000; S249-0366-000	
C20C2	B20C2		12	6			2	A1, A2-str. coax RG-59/U, RG-62/U, P249-0399-000, S249-0398-000	
G20	G20			10	2	8		Basic arr.	
B22C2	32C2		18			2	2	A1-90° Short coax RG-58/U, P249-0409-000, S249-0410-000; A2-Str. coax RG-58/U, P249-0257-000, S249-0258-000, #11-14, 16, 17, 26-29 open	
23C3	23C3		20				3	Basic arr. str. coax RG-7/U, P249-0365-000, S249-0366-000	
23HV1	23C3		20			2		#21, 23-#8 removable; #22-HV kit 7.5K VAC: #16 wire, 20 amps	
G23C3	23C3		20				3	#21-23-str. coax RG-59/U, RG-62/U, P249-0399-000, S249-0398-000	
B28	B28		28					Basic arr.	
30	32C2		28			2		A1, A2-open	
31	32C2		28			3		A1-open; A2-#8 removable	
B31C1	32C2		28			2	1	A1-open; A2-90° short coax, RG-58/U P249-0257-000, S249-0258-000	
32	32C2		28			4		A1, A2-#8 removable	
32C1	32C2		28			3	1	A1-str. coax RG-7/U, P249-0365-000, S249-0366-000 A2-#8 removable	
32C1HV1	32C2		28			2	1	A1-str. coax RG-7/U, P249-0365-000, S249-0366-000 A2-HV kit, 7.5K VAC, #16 wire, 10 amp	
32C2	32C2		28			2	2	Basic arr. A1, A2-str. coax RG-7/U, P249-0365-000, S249-0366-000	
A32	32C2		30			2		A1, A2-#16 removable	
E32C2	32C2		28			2	2	A1, A2-str. coax. RG-58/U, P249-0257-000, S249-0258-000	
T32C2	32C2		28			2	2	S/A E32C2 except RG-58/U insulated	
U32C2	32C2		28			2	2	A1, A2-str. coax RG-59/U, RG-62/U, P249-0399-000, S249-0398-000	
40	40		40					Basic arr.	
A44	A44	16	17		6	5		Basic arr.	
45	45		43		2			Basic arr.	
50	50		50					Basic arr.	
F54	F54		48	12				Basic arr.	
76	76	73	3					Basic arr.	
78	78		78					Basic arr.	
C78	78		78					Contacts accommodate 16-20 wire DPDMA only	
90	90		90					Basic arr.	
112	112	112						Basic arr.	
128	128	128						Basic arr.	

Stripping Instructions

ITT Cannon recommends resistance soldering for all solder contacts, particularly for RF cable where excessive heat will damage the dielectric. Wires should be pre-tinned. Shells, bushings, endbells and junction shells (where applicable) must be slipped over wire bundles before soldering or crimping is started. The mechanical steps in wiring coaxials are described below.

Coax Type	Cable Size	Trim		
		A	B	C
Straight R Coax	RG-7/U	.171 (4.34)	.421 (10.69)	.515 (13.08)
	RG-59/U	.171 (4.34)	.546 (13.87)	.671 (17.04)
	RG-62/U	.171 (4.34)	.543 (13.87)	.671 (17.04)
90° angle R Coax	RG-7/U	.218 (5.54)	.312 (7.92)	.437 (11.10)
	RG-58/U	.218 (5.54)	.531 (13.49)	.593 (15.06)
	RG-59/U	.218 (5.54)	.531 (13.49)	.593 (15.06)
	RG-62/U	.218 (5.54)	.531 (13.49)	.593 (15.06)

R Coaxial (Straight and 90°)

1. Cut cable even. Trim to dimensions shown on tabulation. Care should be taken not to injure the conductor or dielectric.

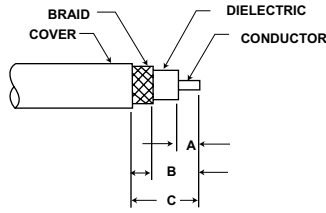

2. Comb braid, tin conductor and remove flux. If a 90° contact is used, bend conductor 90 after tinning.

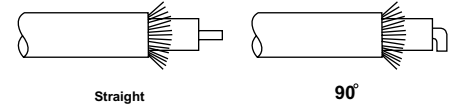

3. Remove solder pot cover. Insert cable and solder conductor to contact. If a straight contact is used, the dielectric should but against contact solder pot.

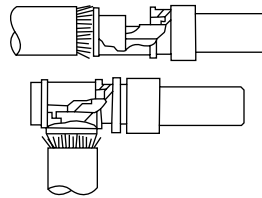

4. Replace solder pot cover and solder braid to ferrule.

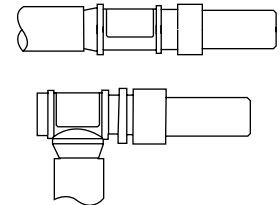

Engaging Devices

Single Gang - DPD/DPDMA

The DPD/DPDMA can be engaged by means of a No. 10-32 steel jack screw and clinch nut. This coupling device is designed to fasten connectors securely when they are used in other than standard rack/ panel applications. The jack screws and clinch nuts are mounted on the shell flanges at the factory. They may be called out on either -33 or -34 shells, although it is preferred to have jack screws on the -33 shell and the clinch nuts on the -34 shell. The device can be ordered on both DPD and DPDMA.

How to Order

DPD-**-34*-1* N DPD-**-33*-1* S
 N = Clinch Nut
 S = Jack Screw

The suffix "N" or "S" is placed immediately after the mounting hole variation; i.e., -1AN, -1AS, etc.

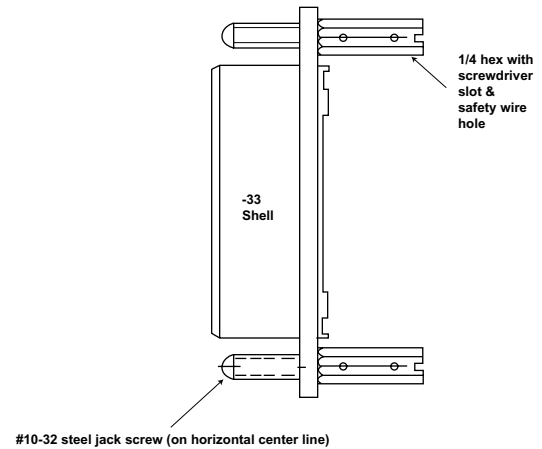
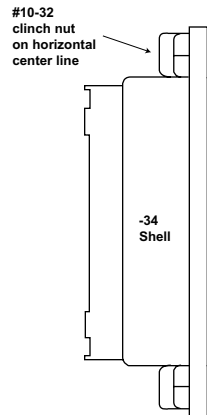

Two Gang - DPD2/DPD2MA

The DPD2 is engaged by means of a variety of screw mechanisms. Engaging devices are interchangeable (within the thread group) with male or female mounting on either 33 or 34 shells. The accompanying tabulation lists the available engaging devices, male opposite female, with which they mate.

How to Order

Engaging Device DPD2 -72C2 -34PCM

Part Number	MALE ENGAGING DEVICES		FEMALE ENGAGING DEVICES		
	Used On	DPD2 DPD2MA	F	CF	DF
M		•	•		
MA		•	•		
CM		•		•	
CMRA		•		•	
DM		•			•
DM-1		•			•
DM-2		•			•
DM-3		•			•
DM-7		•			•

Engaging Devices

Female

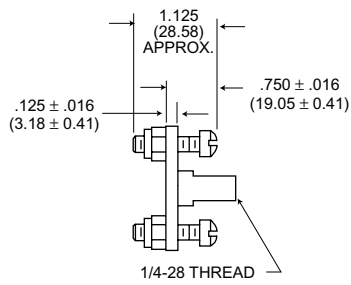

P/N 013837-0010
F
1/4-28 UNF-2B Thread

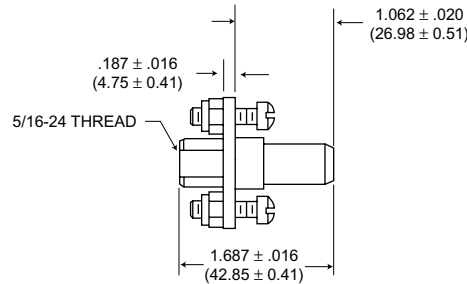

P/N 013837-0003
CF
5/16-24 UNF-2B Thread

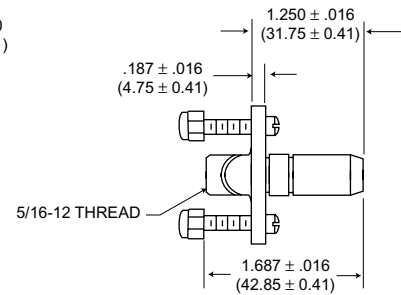

P/N 013837-0013
DF
5/16-12 Quad Lead Thread

Male

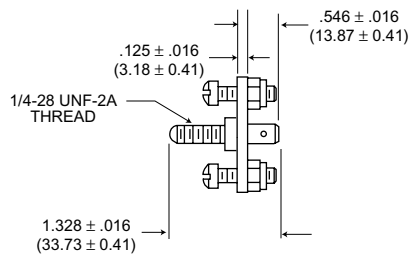

P/N 013837-0008
M
1/4-28 UNF-2A Thread

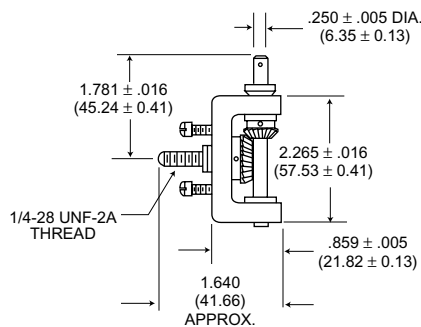

P/N 013837-0001
MA
1/4-28 UNF-2A Thread
NOT FOR USE
WITH POLARIZING POST

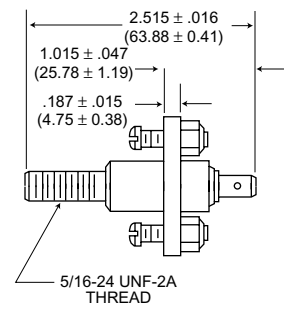

P/N 013837-0005
CM
5/16-24 UNF-2A Thread

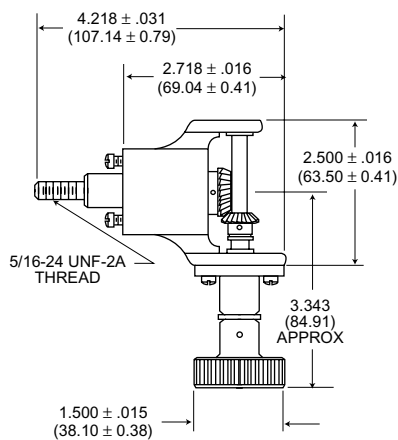

P/N 013837-0042
CMRA
5/16-24 UNF-2A Thread
(Ratchet Lock)

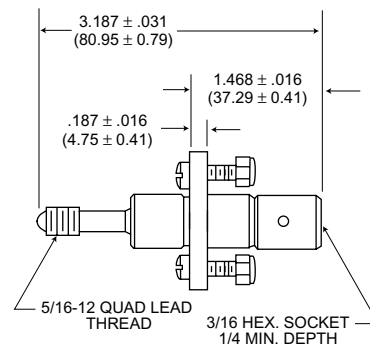

P/N 013837-0012
DM-2
5/16-12 QUAD LEAD Thread

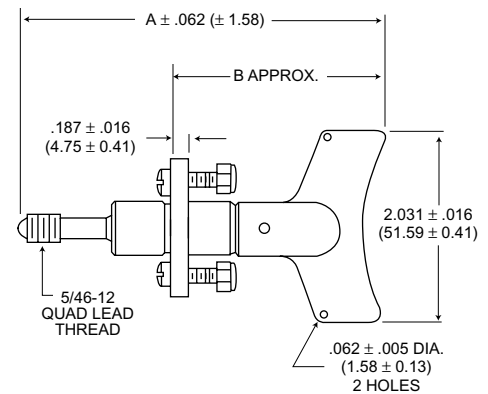

DM-*

	A	B	
DM	3-61/64 (100.41)	2-9/32 (57.94)	013837-0011
*DM-1	5-23/64 (136.13)	3-11/16 (93.86)	013837-0015
*DM-3	6-5/64 (154.38)	4-13/32 (111.92)	013837-0027
*DM-7	7-11/64 (182.17)	5-1/2 (139.70)	013837-0044

5/16-12 QUAD LEAD THREAD

Polarization

DPD/DPDMA



DPD 33 with
POLARIZING POSTS

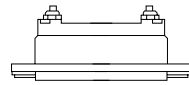

DPD 34 with
POLARIZING KEYWAYS

DPD connectors can be supplied with polarizing posts to provide six or more alternate positions. This feature prevents cross plugging where two identical connectors are mounted close together. Shells with polarizing posts can be ordered by adding the desired position to the part number; for example: DPD-12C4-34P-1A-POS. Y. Polarizing positions are shown below and are face view of the 33 (plug) shell.



POSITION N

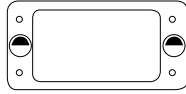

POSITION V

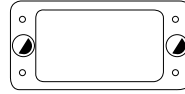

POSITION W

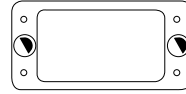

POSITION X

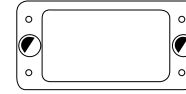

POSITION Y



POSITION Z

Shaded area indicates extended portion of polarizing post.

DPD2/DPD2MA

DPD2 series can be supplied with two polarizing posts to provide six or more alternate positions. This feature is designed to assist in preventing cross

plugging. At present shells are modified upon request only, by adding the desired position to the part number; e.g., DPD2-156-34PM-Pos. V. See

drawing below for available positions. Polarizing positions shown are face view of 33 shell.

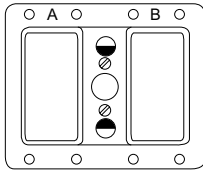

POSITION N

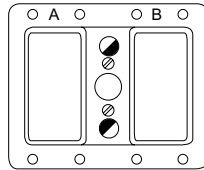

POSITION V

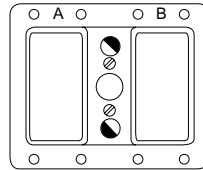

POSITION W

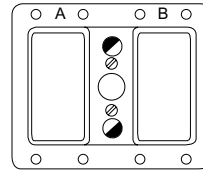

POSITION X

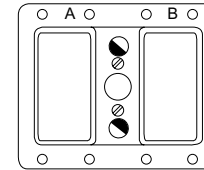

POSITION Y

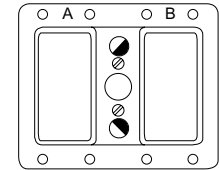

POSITION Z

Shaded area indicates extended portion of polarizing post.

Panel Cutouts

DPD

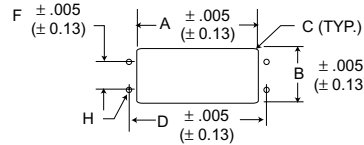

DPD2

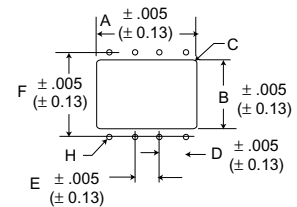

Type	Clearance Hole			Mounting Hole			H Dia.	Gap Between Flanges After Mating
	A	B	C	D	E	F		
	Length Front/Rear Mounting	Width Front/Rear Mounting	Radius Max.					
DPD-34P	2.562 (65.07)	1.562 (39.67)	.181 (4.60)	2.875 (73.02)	-	1.000 (25.40)	.144 (3.66)	.140 (3.56)
DPD-33S	2.421 (61.49)	1.421 (36.09)	.125 (3.18)	2.875 (73.02)	-	1.000 (25.40)	.144 (3.66)	.140 (3.56)
DPD2-34-P	3.781 (96.04)	2.562 (65.07)	.187 (4.75)	1.000 (25.40)	1.250 (31.75)	2.875 (73.02)	.144 (3.66)	.140 (3.56)
DPD2-33S	3.671 (93.24)	2.421 (61.49)	.125 (3.18)	1.000 (25.40)	1.250 (31.75)	2.875 (73.02)	.144 (3.66)	.140 (3.56)

Accessories-DPD Junction Shell

DPD-33
11612

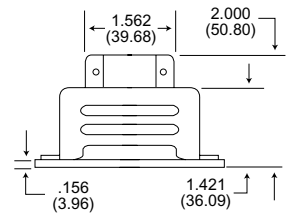
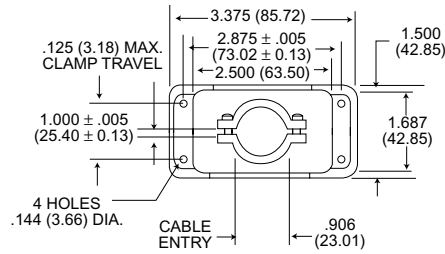

DPD-34
12172

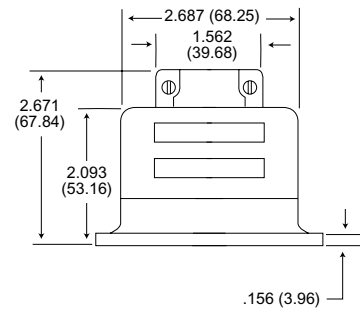
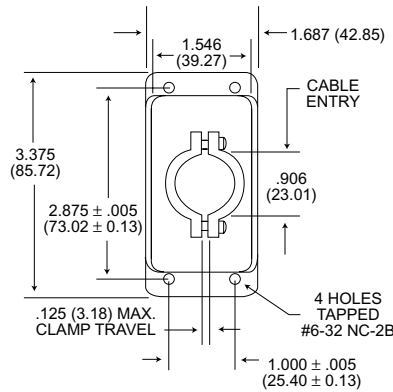

DPD 90°
19929

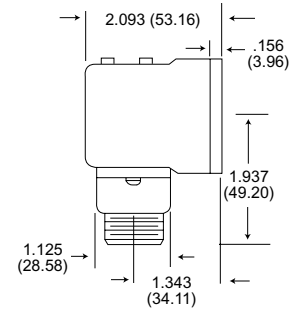
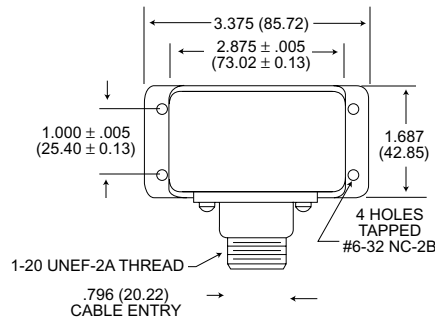

All tolerances ± .015 (0.38) unless otherwise noted.

Accessories-DPD Dust Cap

DPD/DPD2 025-0585-000



Accessories-DPD2

DPD2
19941-1

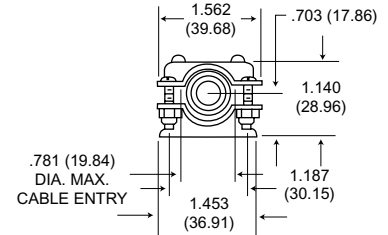
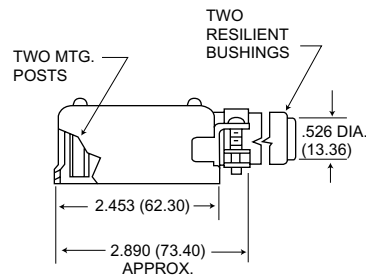

DPD2
19941-2

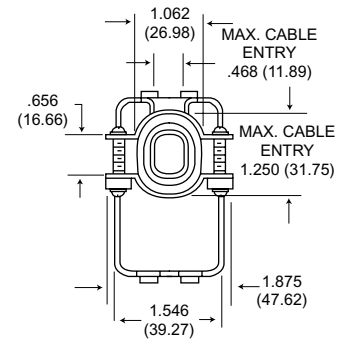
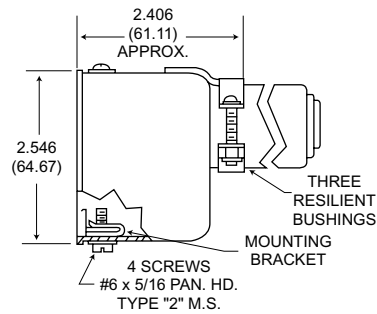

DPD2
19941-3

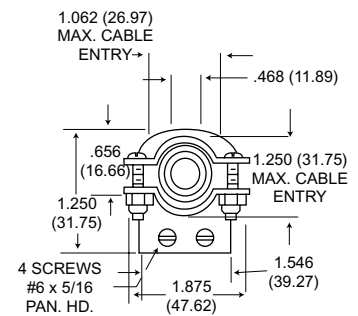
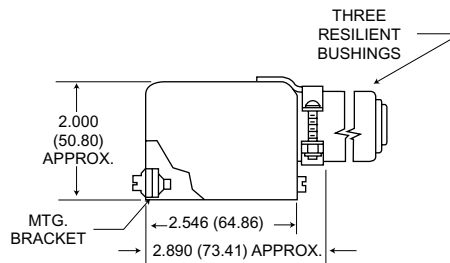

DPD2
19941-7

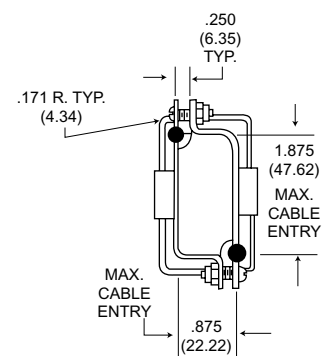
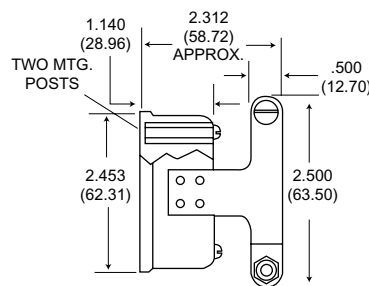

SERIES I

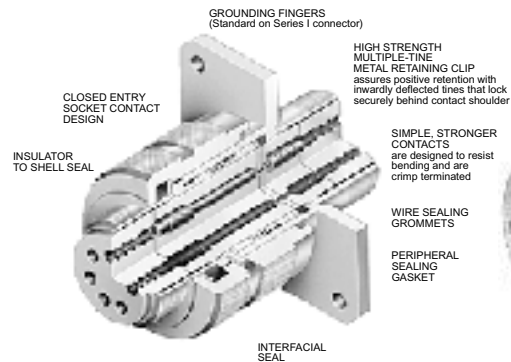

SERIES II

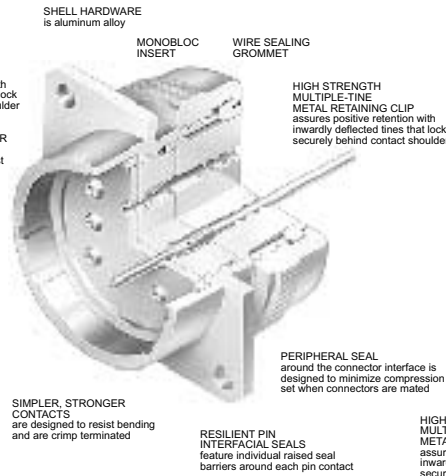

SERIES III

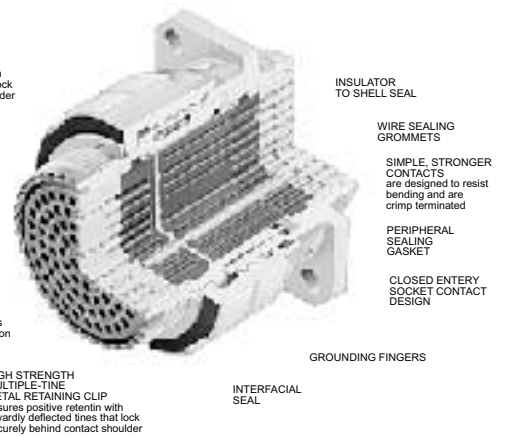

- Corrosion-resistant shells of aluminum alloy with cadmium over nickel plating withstand a 500 hour salt spray exposure
- Rear release crimp snap-in contacts
- High contact density
- Standard MIL-C-39029 contacts, MIL-I-81969 application tools and MIL-STD 1560 insert arrangements
- Special/custom capabilities
- 100% scoop-proof - Series I and III
- Light weight /Low Profile - Series II
- Operates under severe high temperature vibration testing through 200 C - engineered for high density circuitry - Series III
- Interfacial seal helps prevent electrolytic erosion of contacts - Series III
- Superior EMI shielding provides outstanding protection up to 65dB at 10 GHZ. - Series III

Specification Comparison

Design Criteria	Series I	Series II	Series III
Low Profile/Light Weight	no	yes	no
Scoop Proof	yes	no	yes
Coupling System	Bayonet	Bayonet	Triple Lead Thread
Electrolytic Erosion	no	no	yes
Durability (Cycles)	500	250	500
High Impact Shock	yes	no	yes
External Bending Moment			
Shell Size 25	650 in/lbs	150 in/lbs	1000 in/lbs
Random Vibration "J"	Ambient	Ambient	492 F
Sine Vibration	30G, Ambient		60G, -85 to +392 F
Sand, Dust, Ice	yes		yes
Shell Size	9-25	8-24	9-25

Contact Rating

Contact Size	Test Current DC Test Amperage	Maximum Millivolt Drop*	Crimp Well Data	
			Well Diameter	Well Depth
22D	5	40	.0345 ± .0010	.157/.141
22M*	3	30	.0280 ± .0010	.157/.141
22*	5	40	.0365 ± .0010	.157/.141
20	7.5	35	.0470 ± .0010	.229/.209
16	13	25	.0670 ± .0010	.229/.209
12	23	25	.1000 ± .0020	.229/.209

* Maximum millivolt drop data is determined by measuring resistance of mated contacts from end to end.
 • Inactive for new design, available from the factory.

Performance and Material Specifications

MATERIALS AND FINISHES

	Receptacle	Grounded Plug
Shell	Aluminum alloy	Aluminum alloy*
Insulator	High grade plastic	High grade plastic
Contacts	Copper alloy, gold plate	Copper alloy, gold plate
Grommet and Seal	Silicone base elastomer	Silicone base elastomer
Jam Nut	Aluminum alloy	-
Grounding Spring	-	Beryllium copper

*Finish as noted in How To Order sections.

ELECTRICAL DATA

Contact Size: 22D, 22M*, 22*, 20, 16 and 12

Contact Rating and Wire Size Accomodation

Wire Size	Contact Size and Test Amps					
	22D	22M*	22*	20	16	12
28	1.5	1.5	-	-	-	-
26	2.0	2.0	2.0	-	-	-
24	3.0	3.0	3.0	3.0	-	-
22	5.0	-	5.0	5.0	-	-
20	-	-	-	7.5	7.5	-
18	-	-	-	-	10.0	-
16	-	-	-	-	13.0	-
14	-	-	-	-	-	17.0
12	-	-	-	-	-	23.0

Service Rating (Unmated Condition)

Test Voltages	Service Rating M	Service Rating I	Service Rating II
Sea Level	1300	1800	2300
100,000 ft.	200	200	200

Contact Termination; Crimp contact per MIL-C-39029

*Inactive for new design

Test Data

Test Description	Parameters
Durability	500 cycles of mating and unmating, 250 cycles for Series II with spring fingers
Temperature Range	Class F, C; - 65°C (-85°F) to + 200°C (+392°F) Class W: - 65°C (-85°F) to + 175°C (+347°F)
Vibration	Mated connectors are vibrated with weights to simulate rear accessory loads to the following levels: Sine Vibration: Up to 60 G's - Series I & III (at rated temperature - Series III) Not applicable for Series II. Random Vibration: 43.7 Grms at rated temperature - Series III 49.5 Grms at Ambient Temperature - Series I & III 43.7 Grms at Ambient Temperature - Series II
EMI Shielding Effectiveness	Class F: EMI leakage attenuation, greater than 90dB at 100Mhz, greater than 65dB at 10 GHz. Shell to shell conductivity, 1.0 millivolt max. resistance. Class W: EMI leakage attenuation, greater than 90dB at 100 MHz, greater than 50dB at 10 GHz. Shell to shell conductivity, 2.5 millivolt max.
Corrosion Resistant	Class C, W, Y, will withstand 500 hours salt spray. Class F, N, will withstand 48 hours salt spray.
Fluid Immersion	Connectors are fluid resistant to many fuels, solvents, coolants and oils.
High Impact Shock	Mated connectors terminated with MIL-C-915 cable and environmentally sealed backshells will withstand high impact shock per MIL-S-901. Applicable to Series I & III only.
Altitude	Designed to operate between sea level and 100,000 ft. above sea level.
Other Environments	Mated connectors shall withstand sand and dust per method 110 of MIL-STD-202 and be ice resistant. Applicable to Series I & III only.

NOTE: For hermetic standard or test data please consult ITT Cannon Canada.

Insert Availability and Identification

Series II	Series I & III	Service Rating	Total Con-tacts	Contact Size							
				22D	22M*	22*	20	16	12	8	
8-6 •	9-6 •	M	6		6						
8-35	9-35	M	6	6							
8-98	9-98	I	3				3				
	11-4	I	4				4				
10-5	11-5	I	5				5				
10-13 •	11-13 •	M	13		13						
10-35	11-35	M	13	13							
10-98	11-98	I	6				6				
10-99	11-99	I	7				7				
12-3		II	3						3		
12-4	13-4	I	4						4		
12-8	13-8	I	8				8				
12-22 •	13-22 •	M	22		22						
12-35	13-35	M	22	22							
12-98	13-98	I	10				10				
14-5	15-5	II	5						5		
14-15	15-15	I	15				14		1		
14-18	15-18	I	18				18				
	15-19	I	19				19				
14-35	15-35	M	37	37							
14-37 •	15-37 •	M	37		37						
14-97	15-97	I	12				8		4		
16-6	17-6	I	6							6	
16-8	17-8	II	8						8		
16-26	17-26	I	26				26				
16-35	17-35	M	55	55							
16-42 •		M	42			42					
16-55 •	17-55 •	M	55		55						
16-99	17-99	I	23				21		2		
18-11	19-11	II	11						11		
18-28	19-28	I	28				26		2		
18-30	19-30	I	30				29		1		
18-32	19-32	I	32				32				
18-35	19-35	M	66	66							
18-53 •		M	53			53					
18-66 •	19-66 •	M	66		66						
20-1 •	21-1 •	M	79		79						
20-2 •		M	65			65					
	21-11	I	11							11	
20-16	21-16	II	16					16			
20-35	21-35	M	79	79							
20-39	21-39	I	39				37		2		
20-41	21-41	I	41				41				
	21-75	M	4								4**†
22-1 •	23-1 •	M	100		100						
22-2 •	23-2 •	M	85			85					
22-21	23-21	II	21					21			
22-32	23-32	I	32				32				
22-35	23-35	M	100	100							
22-53	23-53	I	53				53				
22-55	23-55	I	55				55				
24-1 •	25-1 •	M	128		128						
24-2 •	25-2 •	M	100			100					
24-4	25-4	I	56				48		8		
	25-19	I	19							19	
24-24	25-24	I	24					12		12	
24-29	25-29	I	29					29			
24-35	25-35	M	128	128							
	25-37	I	37						37		
	25-43	I	43				23		20		
	25-46	I, Coax	46				40		4		2*†
	25-8	Coax	8								8****
	25-20	N	30				10		13		4* 3**
	25-42	I, Coax	42				38				4*
24-61	25-61	I	61				61				
	25-64	I	64	40			8		10		6
	25-66	I	66	53			2		11		

* Coax

** Twinax

*** Coax/Twinax

† For RG180/U and RG195/U cables only (check factory for other cable applications)

• Inactive for new design.



Dimensions are shown in inches (millimeters).
Dimensions subject to change.

www.ittcannon.com

How To Order

Military Nomenclature

MS NUMBER SHELL STYLE

- MS27466 - Wall Mounting Receptacle
- MS27468 - Jam Nut Receptacle
- MS27467 - Grounded Plug
- MS27656 - Wall Mounting Receptacle (back panel mounting)
- MS27505 - Box Mounting Receptacle (back panel) (Class E)

CLASS

- E - Inactive for new design. Superseded by Class T.
- P - Environment - resistant with straight potting cup accessories
- T - Environment - resistant with accessory threads and teeth, except MS27505 (without rear accessory) (Class T not applicable to MS27505)

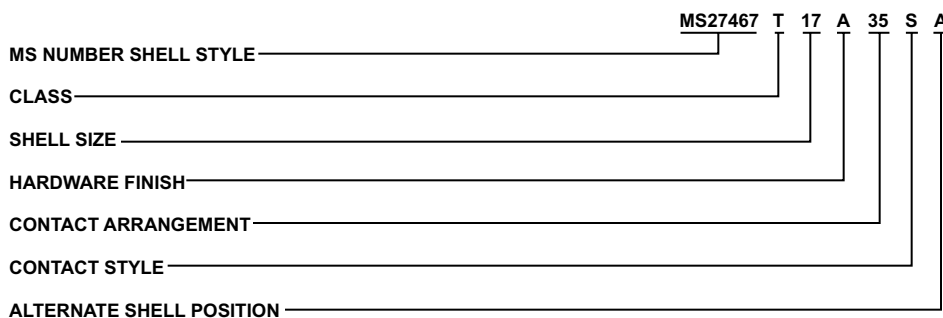

SHELL SIZE
9, 11, 13, 15, 17, 19, 21, 23, and 25

HARDWARE FINISH STANDARD

- A - Bright cadmium over electroless nickel plate, -85°F to +302°F (-65°C to +150°C)
- B - Olive drab cadmium over electroless nickel plate, -85°F to +347°F (-65°C to +175°C)
- F - Electroless nickel, -85°F to +392°F (-65°C to +200°C)

CONTACT ARRANGEMENT

See pages 132 and 133.

CONTACT STYLE

- P - Pin
 - S - Socket
 - *A - Less Pin Contact
 - *B - Less Socket Contact
- See pages 296-298 for fiber Optic contacts.

*Used only when other than power contacts are to be installed (i.e. shielded, thermocouple, etc.)

ALTERNATE SHELL POSITION

A, B, C, and D. (Not required for normal). See page 131.

Note: To order MS connectors less standard power contacts, purchase order must state "Less Contacts"

ITT Cannon Nomenclature

SERIES PERFIX

- KJL - Series I-Scoop proof

SHELL STYLE

- 0 - Wall mounting receptacle
- 3 - Wall mounting receptacle (back panel mounting)
- 5 - Box mounting receptacle (back panel mounting)
- 6 - Straight plug, grounded
- 7 - Jam nut receptacle

CLASS

- E - Inactive for new design. Superseded by Class T.
- F - Environment - resistant with strain relief accessory
- P - Environment - resistant with straight potting cup accessory
- T - Environment - resistant (without rear accessory) (Class T not applicable to KJL5)



NOTE: KJL supplied with exact complement of contacts.

SHELL SIZE
9, 11, 13, 15, 17, 19, 21, 23 and 25

HARDWARE FINISH STANDARD

- A - Bright cadmium over electroless nickel plate, -85°F to +302°F (-65°C to +150°C)
- B - Olive drab cadmium over electroless nickel plate, -85°F to +347°F (-65°C to +175°C)
- N - Electroless nickel, -85°F to +392°F (-65°C to +200°C)

CONTACT ARRANGEMENT

See pages 132 and 133.

CONTACT STYLE

- P - Pin
 - S - Socket
- See pages 296-298 for Fiber Optic Contacts.

ALTERNATE SHELL POSITION

N (normal), A, B, C, D. See page 131.

LESS CONTACTS

Use "L" when connectors are ordered less contacts, sealing plugs and insertion/extraction tool ("L" is not stamped on connectors).

Wall Mounting Receptacle

MS27466
(MS service class E, P, T)

KJL0

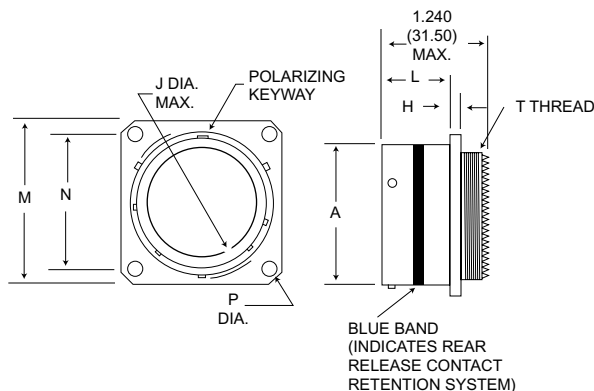

NOTE: For backshell dimensions and configurations, see pages 135 and 136.

Shell Size	A Dia. Max.	H Max.	J Dia. Max.	L Max.	M Max.	N T.P.	P Dia. Max.	T Thread	Overall Length With Backshells	
									F Cable Clamp	P Potting Max.
9	.573 (14.55)	.100 (2.54)	.662 (16.81)	.632 (16.05)	.958 (24.33)	.719 (18.26)	.138 (3.51)	7/16-28UNEF-2A	1.846 (46.89)	1.451 (36.86)
11	.701 (17.81)	.100 (2.54)	.810 (20.57)	.632 (16.05)	1.051 (26.70)	.812 (20.62)	.138 (3.51)	9/16-24UNEF-2A	1.846 (46.89)	1.451 (36.86)
13	.851 (21.62)	.100 (2.54)	.960 (24.38)	.632 (16.05)	1.145 (29.08)	.906 (23.01)	.138 (3.51)	11/16-24UNEF-2A	1.846 (46.89)	1.451 (36.86)
15	.976 (24.79)	.100 (2.54)	1.085 (27.56)	.632 (16.05)	1.239 (31.47)	.969 (24.61)	.138 (3.51)	13/16-20UNEF-2A	1.846 (46.89)	1.451 (36.86)
17	1.101 (27.97)	.100 (2.54)	1.210 (30.73)	.632 (16.05)	1.332 (33.83)	1.062 (26.97)	.138 (3.51)	15/16-20UNEF-2A	1.966 (49.94)	1.451 (36.86)
19	1.208 (30.68)	.100 (2.54)	1.317 (33.45)	.632 (16.05)	1.458 (37.03)	1.156 (29.36)	.138 (3.51)	1-1/16-18UNEF-2A	1.966 (50.70)	1.451 (36.86)
21	1.333 (33.86)	.130 (3.30)	1.442 (36.63)	.602 (15.29)	1.582 (40.18)	1.250 (31.75)	.138 (3.51)	1-3/16-18UNEF-2A	1.966 (50.70)	1.451 (36.86)
23	1.458 (37.03)	.130 (3.30)	1.567 (39.80)	.602 (15.29)	1.708 (43.38)	1.375 (34.93)	.157 (3.99)	1-5/16-18UNEF-2A	1.966 (50.70)	1.451 (36.86)
25	1.583 (40.21)	.130 (3.30)	1.692 (42.98)	.602 (15.29)	1.832 (46.53)	1.500 (38.10)	.157 (3.99)	1-7/16-18UNEF-2A	1.966 (50.70)	1.451 (36.86)

Wall Mounting Receptacle (Back Panel)

MS27656
(MS service class E, P, T)

KJL3

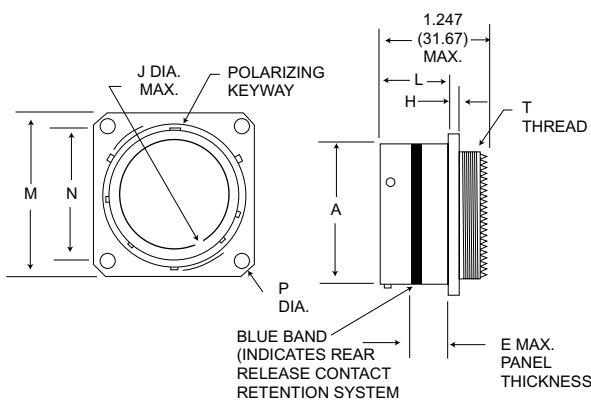

NOTE: For backshell dimensions and configurations, see pages 135 and 136.

Shell Size	A Dia. Max.	E Max.	H Dia. Max.	J Dia. Max.	L Max.	M Max.	N T.P.	P Dia. Max.	T Thread	Overall Length With Backshells	
										F Cable Clamp	P Potting Max.
9	.573 (14.55)	.234 (5.94)	.100 (2.54)	.662 (16.81)	.820 (20.83)	.958 (24.33)	.719 (18.26)	.138 (3.51)	7/16-28UNEF-2A	1.805 (45.85)	1.410 (35.81)
11	.701 (17.81)	.234 (5.94)	.100 (2.54)	.810 (20.57)	.820 (20.83)	1.051 (26.70)	.812 (20.62)	.138 (3.51)	9/16-24UNEF-2A	1.805 (45.85)	1.410 (35.81)
13	.851 (21.62)	.234 (5.94)	.100 (2.54)	.960 (24.38)	.820 (20.83)	1.145 (29.08)	.906 (23.01)	.138 (3.51)	11/16-24UNEF-2A	1.805 (45.85)	1.410 (35.81)
15	.976 (24.79)	.234 (5.94)	.100 (2.54)	1.085 (27.56)	.820 (20.83)	1.239 (31.47)	.969 (24.61)	.138 (3.51)	13/16-20UNEF-2A	1.805 (45.85)	1.410 (35.81)
17	1.101 (27.97)	.234 (5.94)	.100 (2.54)	1.210 (30.73)	.820 (20.83)	1.332 (33.83)	1.062 (26.97)	.138 (3.51)	15/16-20UNEF-2A	1.935 (48.90)	1.410 (35.81)
19	1.208 (30.68)	.234 (5.94)	.100 (2.54)	1.317 (33.45)	.820 (20.83)	1.458 (37.03)	1.156 (29.36)	.138 (3.51)	1-1/16-18UNEF-2A	1.955 (49.66)	1.410 (35.81)
21	1.333 (33.86)	.204 (5.18)	.130 (3.30)	1.442 (36.63)	.790 (20.07)	1.582 (40.18)	1.250 (31.75)	.138 (3.51)	1-3/16-18UNEF-2A	1.955 (49.66)	1.410 (35.81)
23	1.458 (37.03)	.204 (5.18)	.130 (3.30)	1.567 (39.80)	.790 (20.07)	1.708 (43.38)	1.375 (34.93)	.157 (3.99)	1-5/16-18UNEF-2A	1.955 (49.66)	1.410 (35.81)
25	1.583 (40.21)	.193 (4.90)	.130 (3.30)	1.692 (42.98)	.790 (20.07)	1.832 (46.53)	1.500 (38.10)	.157 (3.99)	1-7/16-18UNEF-2A	1.955 (49.66)	1.410 (35.81)

Performance Specifications-Pages 115-116 Contacts, Sealing Plugs, Assembly Tools - Pages 134, 136-137 Contact Arrangements - Pages 132-133

Box Mounting Rectacle (Back Panel)

MS27505E
(MS service class E)

KJL5E

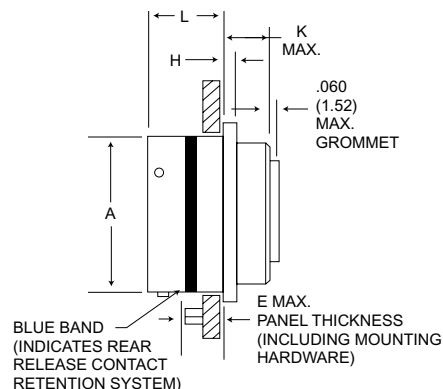
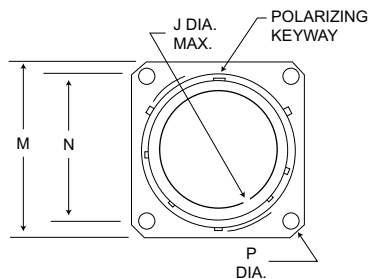

NOTE: This connector does not accommodate backshells.

Shell Size	A Dia. Max.	E Max.	H Max.	J Dia. Max.	K Max.	L Max.	M Max.	N T.P.	P Dia. Max.
9	.573 (14.55)	.234 (5.94)	.100 (2.54)	.662 (16.81)	.219 (5.56)	.820 (20.83)	.958 (24.33)	.719 (18.26)	.138 (3.51)
11	.701 (17.81)	.234 (5.94)	.100 (2.54)	.810 (20.57)	.219 (5.56)	.820 (20.83)	1.051 (26.70)	.812 (20.62)	.138 (3.51)
13	.851 (21.62)	.234 (5.94)	.100 (2.54)	.960 (24.38)	.219 (5.56)	.820 (20.83)	1.145 (29.08)	.906 (23.01)	.138 (3.51)
15	.976 (24.79)	.234 (5.94)	.100 (2.54)	1.085 (27.56)	.219 (5.56)	.820 (20.83)	1.239 (31.47)	.969 (24.61)	.138 (3.51)
17	1.101 (27.97)	.234 (5.94)	.100 (2.54)	1.210 (30.73)	.219 (5.56)	.820 (20.83)	1.332 (33.83)	1.062 (26.97)	.138 (3.51)
19	1.208 (30.68)	.234 (5.94)	.100 (2.54)	1.317 (33.45)	.219 (5.56)	.820 (20.83)	1.458 (37.03)	1.156 (29.36)	.138 (3.51)
21	1.333 (33.86)	.204 (5.18)	.130 (3.30)	1.442 (36.63)	.250 (6.35)	.790 (20.07)	1.582 (40.18)	1.250 (31.75)	.138 (3.51)
23	1.458 (37.03)	.204 (5.18)	.130 (3.30)	1.567 (39.80)	.250 (6.35)	.790 (20.07)	1.708 (43.38)	1.375 (34.93)	.157 (3.99)
25	1.583 (40.21)	.193 (4.90)	.130 (3.30)	1.692 (42.98)	.250 (6.35)	.790 (20.07)	1.832 (46.53)	1.500 (38.10)	.157 (3.99)

Straight Plug Grounded

MS27467
(MS service class E, P, T)

KJL6

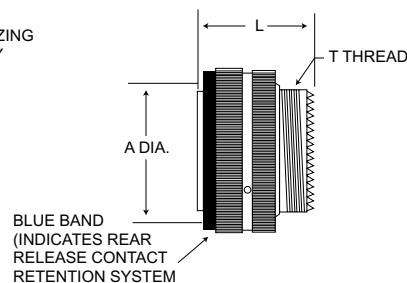
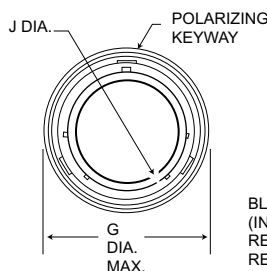

NOTE: For backshell dimensions and configurations, see pages 135 and 136.

Shell Size	A Max.	G Dia. Max.	J Dia. Max.	(Class T)		Overall Length With Backshells	
				L Max.	T Thread	F Cable Clamp	P Potting Max.
9	.585 (14.86)	.859 (21.82)	.483 (12.27)	1.234 (31.34)	7/16-28UNEF-2A	1.793 (45.54)	1.671 (42.44)
11	.717 (18.21)	.984 (24.99)	.611 (15.52)	1.234 (31.34)	9/16-24UNEF-2A	1.793 (45.54)	1.671 (42.44)
13	.866 (22.00)	1.156 (29.36)	.760 (19.30)	1.234 (31.34)	11/16-24UNEF-2A	1.793 (45.54)	1.671 (42.44)
15	.990 (25.15)	1.281 (32.54)	.885 (22.48)	1.234 (31.34)	13/16-20UNEF-2A	1.793 (45.54)	1.671 (42.44)
17	1.115 (28.32)	1.406 (35.71)	1.010 (25.65)	1.234 (31.34)	15/16-20UNEF-2A	1.913 (48.59)	1.671 (42.44)
19	1.222 (31.04)	1.516 (38.51)	1.115 (28.32)	1.234 (31.34)	1-1/16-18UNEF-2A	1.943 (49.35)	1.671 (42.44)
21	1.347 (34.21)	1.641 (41.68)	1.240 (31.50)	1.234 (31.34)	1-3/16-18UNEF-2A	1.943 (49.35)	1.766 (44.86)
23	1.472 (37.39)	1.766 (44.86)	1.365 (34.67)	1.234 (31.34)	1-5/16-18UNEF-2A	1.943 (49.35)	1.766 (44.86)
25	1.597 (40.56)	1.891 (48.03)	1.490 (37.85)	1.234 (31.34)	1-7/16-18UNEF-2A	1.943 (49.35)	1.766 (44.86)

Performance Specifications-Pages 115-116

Contacts, Sealing Plugs, Assembly Tools - Pages 134, 136-137

Contact Arrangements - Pages 132-133



Dimensions are shown in inches (millimeters).
Dimensions subject to change.

www.ittcannon.com

Jam Nut Receptacle

MS27468

KJL7

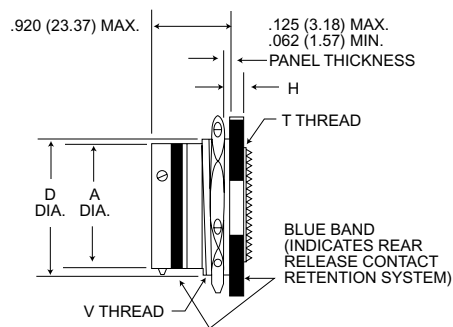
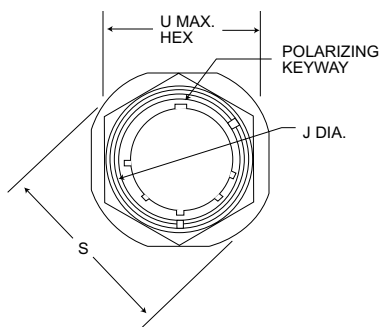

NOTE: For backshell dimensions and configurations, see pages 135 and 136.

Shell Size	A Dia. Max.	D Max.	H Max.	J Dia. Max.	S Dia. Max.	T Thread	U Max. Hex.	V Thread Class 2A	Overall Length With Backshells	
									F Cable Clamp	P Potting Max.
9	.573 (14.55)	.655 (16.64)	.120 (3.05)	.662 (16.81)	1.204 (30.58)	7/16-28UNEF-2A	.892 (22.66)	11/16-24UNEF	1.846 (46.89)	1.451 (36.86)
11	.701 (17.81)	.755 (19.18)	.120 (3.05)	.810 (20.57)	1.391 (35.33)	9/16-24UNEF-2A	1.017 (25.83)	13/16-24UNEF	1.846 (46.89)	1.451 (36.86)
13	.851 (21.62)	.942 (23.93)	.120 (3.05)	.960 (24.38)	1.516 (35.51)	11/16-24UNEF-2A	1.205 (30.61)	1-20UNEF	1.846 (46.89)	1.451 (36.86)
15	.976 (24.79)	1.066 (27.08)	.120 (3.05)	1.085 (27.56)	1.641 (41.68)	13/16-20UNEF-2A	1.329 (33.76)	1-1/8-18UNEF	1.846 (46.89)	1.451 (36.86)
17	1.101 (27.97)	1.191 (30.25)	.120 (3.05)	1.210 (30.73)	1.766 (44.86)	15/16-20UNEF-2A	1.455 (36.96)	1-1/4-18UNEF	1.966 (49.94)	1.451 (36.86)
19	1.208 (30.68)	1.316 (33.43)	.151 (3.84)	1.317 (33.45)	1.954 (49.63)	1-1/16-18UNEF-2A	1.579 (40.11)	1-3/4-18UNEF	1.996 (50.70)	1.451 (36.86)
21	1.333 (33.86)	1.441 (36.60)	.151 (3.84)	1.442 (36.63)	2.078 (52.78)	1-3/16-18UNEF-2A	1.705 (43.31)	1-1/2-18UNEF	1.996 (50.70)	1.451 (36.86)
23	1.458 (37.03)	1.566 (39.78)	.151 (3.84)	1.567 (39.80)	2.204 (55.98)	1-5/16-18UNEF-2A	1.829 (46.46)	1-5/8-18UNEF	1.996 (50.70)	1.451 (36.86)
25	1.583 (40.21)	1.691 (42.95)	.151 (3.84)	1.692 (42.98)	2.328 (59.13)	1-7/16-18UNEF-2A	20.17 (51.23)	1-3/4-18UNS	1.996 (50.70)	1.451 (36.86)

Performance Specifications - Pages 115-116

Contacts, Sealing Plugs, Assembly Tools - Pages 134, 136-137

Contacts Arrangements - Pages 132-133

Panel Cutouts

Flange Mounted Receptacles

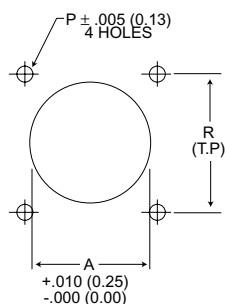

Jam Nut Receptacles

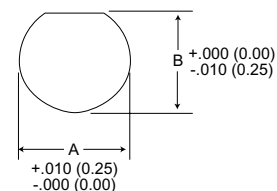

(Class T)

Shell Size	A Dia.	P Dia.	R	Mtg. Screw
9	.665 (16.89)	1.25 (3.18)	.719 (18.26)	#4
11	.812 (20.62)	1.25 (3.18)	.812 (20.62)	#4
13	.965 (24.51)	1.25 (3.18)	.906 (23.01)	#4
15	1.085 (27.55)	1.25 (3.18)	.969 (24.61)	#4
17	1.210 (30.73)	1.25 (3.18)	1.062 (26.7)	#4
19	1.322 (33.57)	1.25 (3.18)	1.156 (29.36)	#4
21	1.447 (36.75)	1.25 (3.18)	1.250 (31.75)	#4
23	1.569 (39.85)	1.25 (3.18)	1.375 (34.93)	#6
25	1.703 (43.25)	1.25 (3.18)	1.500 (38.10)	#6

Shell Size	A Dia.	B Dia.
9	.700 (17.28)	.670 (17.02)
11	.825 (20.96)	.770 (19.59)
13	1.010 (25.65)	.955 (24.26)
15	1.135 (28.83)	1.085 (27.56)
17	1.260 (32.00)	1.210 (30.73)
19	1.385 (35.18)	1.335 (33.91)
21	1.510 (38.35)	1.460 (37.08)
23	1.635 (41.53)	1.585 (40.26)
25	1.760 (44.70)	1.710 (43.43)

How To Order

Military Nomenclature

MS NUMBER SHELL STYLE

- MS27472 - Wall Mounting Receptacle
- MS27473 - Straight Plug
- MS27474 - Jam Nut Receptacle
- MS27484 - Grounded Plug
- MS27497 - Wall Mounting Receptacle (back panel mounting)
- MS27513 - Box Mounting Receptacle
- MS27479 - Wall Mounting Receptacle (C Finish) - Inactive, use MS27472
- MS27480 - Straight Plug (C Finish) - inactive, use MS27473
- MS27481 - Jam Nut Receptacle (C Finish) - inactive, use MS27474
- MS27499 - Box Mounting Receptacle (Class E)
- MS27508 - Box Mounting (back panel mounting) (Class E)

CLASS

- E - Environment - resistant with rear accessory (without strain relief)
- P - Environment - resistant with straight potting cup accessories
- T - Environment - resistant (without rear accessory). (Class T not applicable to MS27499, MS27513, and MS27508.)

MS NUMBER SHELL STYLE _____

CLASS _____

SHELL SIZE _____

HARDWARE FINISH _____

CONTACT ARRANGEMENT _____

CONTACT STYLE _____

ALTERNATE SHELL POSITION _____

SHELL SIZE

8, 10, 12, 14, 16, 18, 20, 22, 24.

HARDWARE FINISH STANDARD

- A - Bright cadmium over electroless nickel plates, - 85°F to + 302°F (- 65°C to + 150°C)
- B - Olive drab cadmium over electroless nickel plate, - 85°F to + 347°F (- 65°C to + 175°C)
- C - Anodic (non-conductive), - 85°F to + 392°F (-65°C to + 200°C).
Not applicable to MS27484.
- F - Electroless nickel, - 85°F to + 392°F (-65°C to + 200°C)

CONTACT ARRANGEMENT

See pages 132 and 133.

CONTACT STYLE

- P - Pin
- S - Socket
- *A - Less Pin Contact
- *B - Less Socket Contact

*Used only when other than power contacts are to be installed (i.e. shielded, thermocouple, etc.)

ALTERNATE SHELL POSITION

A, B, C, and D (not required for normal). See page 131.

Note: To order MS connectors less standard power contacts, purchase order must state "Less Contacts".

MS27473 T 18 A 35 S A

ITT Cannon Nomenclature

SERIES PREFIX

- KJ - Series II - Low Profile

SHELL STYLE

- 0 - Wall mounting receptacle
- 2 - Box mounting receptacle (available as hermetic)
- 3 - Wall mounting receptacle (back panel mounting)
- 5 - Box mounting receptacle (back panel mounting)
- 6 - Straight plug
- G6 - Straight plug, grounded
- 7 - Jam nut receptacle (available as hermetic)

CLASS

- E - Environment - resistant with rear accessory (without strain relief)
- F - Environment - resistant with strain relief accessory
- P - Environment - resistant with straight potting cup accessory
- R - Environment - resistant with full grommet seal without rear accessory; shell styles 2 and 5 only
- T - Environment - resistant (without rear accessory). (Class T not applicable to KJ2E, KJ2R, KJ5E and KJ5R.)

SERIES PREFIX _____

SHELL STYLE _____

CLASS _____

SHELL SIZE _____

HARDWARE FINISH _____

CONTACT ARRANGEMENT _____

CONTACT STYLE _____

SHELL POSITION _____

LESS CONTACTS _____

Note KJ supplied with exact complement of contacts.

SHELL SIZE

8, 10, 12, 14, 16, 18, 20, 22, and 24.

HARDWARE FINISH STANDARD

- A - Bright cadmium over electroless nickel plates, - 85°F to + 302°F (- 65°C to + 150°C)
- B - Olive drab cadmium over electroless nickel plate, - 85°F to + 347°F (- 65°C to + 175°C)
- C - Anodic (non-conductive), - 85°F to + 392°F (-65°C to + 200°C). Not applicable to KJG6.
- N - Electroless nickel, - 85°F to + 392°F (-65°C to + 200°C)

CONTACT ARRANGEMENT

See pages 132 and 133.

CONTACT STYLE

- P - Pin
- S - Socket

ALTERNATE SHELL POSITION

N(normal), A, B, C, D, see page 131.

LESS CONTACTS

Use "L" when connectors are ordered less contacts, sealing plugs and insertion/extraction tool. ("L" is not stamped on connectors.)

KJ 6 T 18 A 35 S N L

Wall Mounting Receptacle

MS27472
(MS service class E, P, T)

KJ0

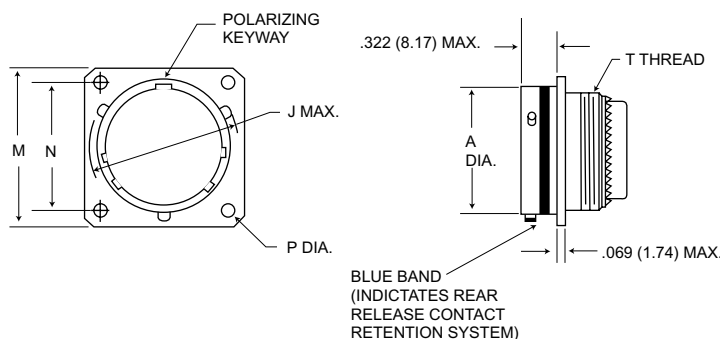

NOTE: For backshell dimensions and configurations, see page 135 and 136

Shell Size	A Dia. Max.	J Dia. Max.	M Max.	N T.P.	P +.005 (0.13) -0.010 (0.25)	T Thread	Overall length With Backshells		
							E Straight	F Cable Clamp	P Potting Max.
8	.474 (12.04)	.563 (14.30)	.828 (21.03)	.594 (15.09)	.125 (3.18)	7/16-28UNEF-2A	.850 (21.59)	1.555 (39.50)	1.020 (25.91)
10	.591 (15.01)	.680 (17.27)	.954 (24.23)	.719 (18.26)	.125 (3.18)	9/16-24UNEF-2A	.850 (21.59)	1.555 (39.50)	1.020 (25.91)
12	.751 (19.08)	.859 (21.82)	1.047 (26.59)	.812 (20.62)	.125 (3.18)	11/16-24UNEF-2A	.850 (21.59)	1.555 (39.50)	1.020 (25.91)
14	.876 (22.25)	.984 (24.99)	1.141 (28.98)	.906 (23.01)	.125 (3.18)	13/16-20UNEF-2A	.850 (21.59)	1.790 (45.47)	1.020 (25.91)
16	1.001 (25.43)	1.108 (28.14)	1.234 (31.34)	.969 (24.61)	.125 (3.18)	15/16-20UNEF-2A	.850 (21.59)	1.790 (45.47)	1.020 (25.91)
18	1.126 (28.60)	1.233 (31.32)	1.328 (33.73)	1.062 (26.97)	.125 (3.18)	1-1/16-18UNEF-2A	.850 (21.59)	1.790 (45.47)	1.020 (25.91)
20	1.251 (31.78)	1.358 (34.49)	1.453 (36.91)	1.156 (27.36)	.125 (3.18)	1-3/16-18UNEF-2A	.850 (21.59)	1.790 (45.47)	1.020 (25.91)
22	1.376 (34.95)	1.483 (37.67)	1.578 (39.08)	1.250 (31.76)	.125 (3.18)	1-5/16-18UNEF-2A	.850 (21.59)	1.930 (49.02)	1.020 (25.91)
24	1.501 (38.13)	1.610 (40.89)	1.703 (43.26)	1.375 (34.92)	.152 (3.86)	1-7/16-18UNEF-2A	.850 (21.59)	1.900 (48.26)	1.080 (27.43)

Box Mounting Receptacle

MS27499E
(MS service class E)

KJ2E

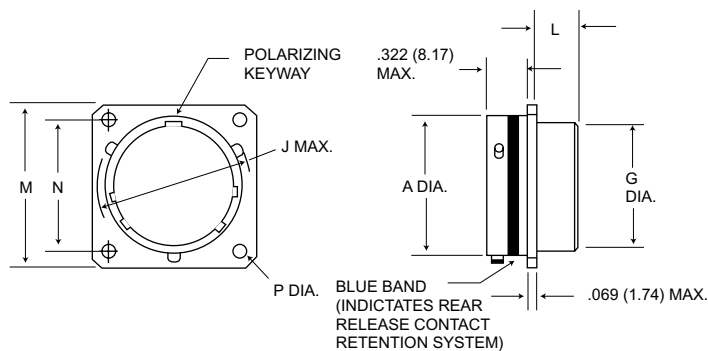

NOTE: This connector does not accommodate backshells

Shell Size	A Dia. Max.	G Dia. Max.	J Dia. Max.	L Max.	M Max.	N T.P.	P +.005 (0.13) -0.010 (0.25)
8	.474 (12.04)	.421 (10.69)	.563 (14.30)	.312 (7.92)	.828 (21.03)	.594 (15.09)	.125 (3.18)
10	.591 (15.01)	.542 (13.77)	.680 (17.27)	.312 (7.92)	.954 (24.23)	.719 (18.26)	.125 (3.18)
12	.751 (19.08)	.667 (16.94)	.859 (21.82)	.312 (7.92)	1.047 (26.59)	.812 (20.62)	.125 (3.18)
14	.876 (22.25)	.791 (20.09)	.984 (24.99)	.312 (7.92)	1.141 (28.98)	.906 (23.01)	.125 (3.18)
16	1.001 (25.43)	.916 (23.27)	1.108 (28.14)	.312 (7.92)	1.234 (31.34)	.969 (24.61)	.125 (3.18)
18	1.126 (28.60)	1.034 (26.26)	1.233 (31.32)	.312 (7.92)	1.328 (33.73)	1.062 (26.97)	.125 (3.18)
20	1.251 (31.78)	1.158 (29.41)	1.358 (34.49)	.312 (7.92)	1.453 (36.81)	1.156 (27.36)	.125 (3.18)
22	1.376 (34.95)	1.283 (32.59)	1.483 (37.67)	.312 (7.92)	1.578 (40.08)	1.250 (31.75)	.125 (3.18)
24	1.501 (38.13)	1.408 (35.76)	1.610 (40.89)	.312 (7.92)	1.703 (43.26)	1.375 (34.93)	.152 (3.86)

Performance Specifications - Pages 115-116

Contacts, Sealing Plugs, Assembly Tools - Pages 134, 136 - 137

Contact Arrangements - Pages 132 - 133

Box Mounting Receptacle

MS27513E
(MS service class E)

KJ2R

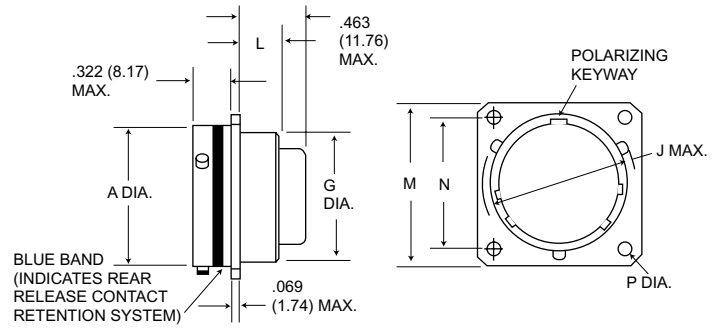

NOTE: This connector does not accommodate backshells

Shell Size	A Dia. Max.	G Dia. Max.	J Dia. Max.	L Max.	M Max.	N T.P.	P +.005 (0.13) -0.010 (0.25)
8	.474 (12.04)	.421 (10.69)	.563 (14.30)	.312 (7.92)	.828 (21.03)	.594 (15.09)	.125 (3.18)
10	.591 (15.01)	.542 (13.77)	.680 (17.27)	.312 (7.92)	.954 (24.23)	.719 (18.26)	.125 (3.18)
12	.751 (19.08)	.667 (16.94)	.859 (21.82)	.312 (7.92)	1.047 (26.59)	.812 (20.62)	.125 (3.18)
14	.876 (22.25)	.791 (20.09)	.984 (24.99)	.312 (7.92)	1.141 (28.98)	.906 (23.01)	.125 (3.18)
16	1.001 (25.43)	.916 (23.27)	1.108 (28.14)	.312 (7.92)	1.234 (31.34)	.969 (24.61)	.125 (3.18)
18	1.126 (28.60)	1.034 (26.26)	1.233 (31.32)	.312 (7.92)	1.328 (33.73)	1.062 (26.97)	.125 (3.18)
20	1.251 (31.78)	1.158 (29.41)	1.358 (34.49)	.312 (7.92)	1.453 (36.81)	1.156 (27.36)	.125 (3.18)
22	1.376 (33.95)	1.283 (32.59)	1.483 (27.67)	.312 (7.92)	1.578 (40.08)	1.250 (31.75)	.125 (3.18)
24	1.501 (38.13)	1.408 (35.76)	1.610 (40.89)	.312 (7.92)	1.703 (43.26)	1.375 (34.93)	.152 (3.85)

Wall Mounting Receptacle

MS27497
(MS service class E, P, T)

KJ3

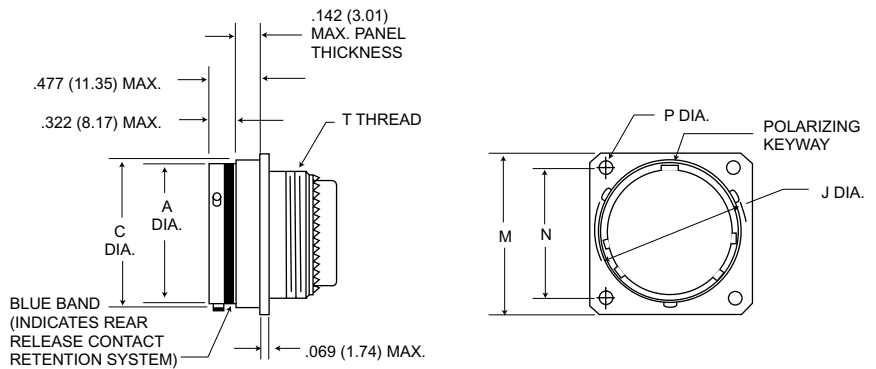

NOTE: For backshell dimensions and configurations, see page 135 and 136

Shell Size	A Dia. Max.	C Dia. Max.	J Dia. Max.	M Max.	N T.P.	P +.005 (0.13) -0.010 (0.25)	T Thread	Overall length With Backshells		
								E Straight	F Cable Clamp	P Potting Max.
8	.474 (12.04)	.522 (13.26)	.563 (14.30)	.828 (21.03)	.594 (15.09)	.125 (3.18)	7/16-28UNEF-2A	.855 (21.72)	1.570 (39.88)	1.020 (25.91)
10	.591 (15.01)	.639 (16.23)	.680 (17.27)	.954 (24.23)	.719 (18.26)	.125 (3.18)	9/16-24UNEF-2A	.855 (21.72)	1.570 (39.88)	1.020 (25.91)
12	.751 (19.08)	.808 (20.52)	.859 (21.82)	1.047 (26.59)	.812 (20.62)	.125 (3.18)	11/16-24UNEF-2A	.855 (21.72)	1.570 (39.88)	1.020 (25.91)
14	.876 (22.25)	.935 (23.75)	.984 (24.99)	1.141 (28.98)	.906 (23.01)	.125 (3.18)	13/16-20UNEF-2A	.855 (21.72)	1.780 (45.21)	1.020 (25.91)
16	1.001 (25.43)	1.058 (26.87)	1.108 (28.14)	1.234 (31.34)	.969 (24.61)	.125 (3.18)	15/16-20UNEF-2A	.855 (21.72)	1.780 (45.21)	1.020 (25.91)
18	1.126 (28.60)	1.183 (30.05)	1.233 (31.32)	1.328 (33.73)	1.062 (26.97)	.125 (3.18)	1-1/16-18UNEF-2A	.855 (21.72)	1.780 (45.21)	1.020 (25.91)
20	1.251 (31.78)	1.308 (33.22)	1.358 (34.49)	1.453 (36.91)	1.156 (29.36)	.125 (3.18)	1-3/16-18UNEF-2A	.855 (21.72)	1.780 (45.21)	1.020 (25.91)
22	1.376 (34.95)	1.433 (36.40)	1.483 (37.67)	1.578 (40.08)	1.250 (31.75)	.125 (3.18)	1-5/16-18UNEF-2A	.855 (21.72)	1.960 (49.78)	1.020 (25.91)
24	1.501 (38.13)	1.568 (39.83)	1.610 (40.89)	1.703 (43.26)	1.375 (34.93)	.152 (3.86)	1-7/16-18UNEF-2A	.855 (21.72)	1.960 (49.78)	1.080 (27.43)

Performance Specifications - Pages 115-116

Contacts, Sealing Plugs, Assembly Tools - Pages 134, 136 - 137

Contact Arrangements - Pages 132 - 133



Dimensions are shown in inches (millimeters).
Dimensions subject to change.

www.ittcannon.com

Box Mounting Receptacle (Back Panel)

MS27508E
(MS service class E)

KJ5E

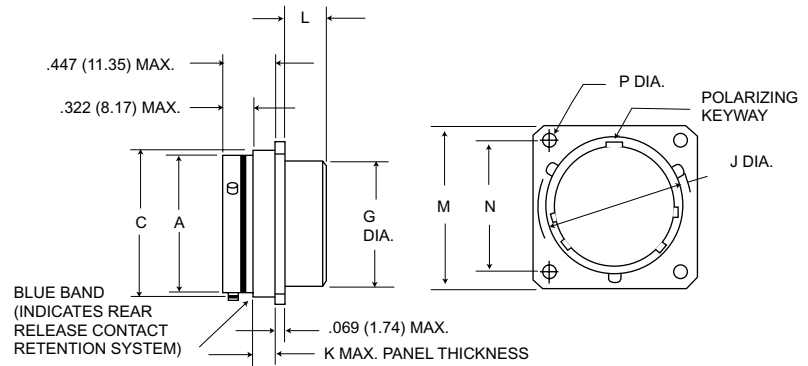

NOTE: This connector does not accommodate backshells

Shell Size	A Dia. Max.	C Dia. Max.	G Dia. Max.	J Dia. Max.	K Max.	L Max.	M Max.	N T.P.	P +.005 (0.13) - .010 (0.25)
8	.474 (12.04)	.522 (13.26)	.421 (10.69)	.563 (14.30)	.147 (3.73)	.185 (4.70)	.828 (21.03)	.594 (15.09)	.125 (3.18)
10	.591 (15.01)	.639 (16.23)	.542 (13.77)	.680 (17.27)	.152 (3.86)	.185 (4.70)	.954 (24.23)	.719 (18.26)	.125 (3.18)
12	.751 (19.08)	.808 (20.52)	.667 (16.94)	.859 (21.82)	.152 (3.86)	.185 (4.70)	1.047 (26.59)	.812 (20.62)	.125 (3.18)
14	.876 (22.25)	.935 (23.75)	.791 (20.09)	.984 (24.99)	.152 (3.86)	.185 (4.70)	1.141 (28.98)	.906 (23.01)	.125 (3.18)
16	1.001 (25.42)	1.058 (26.87)	.916 (23.27)	1.108 (28.14)	.152 (3.86)	.185 (4.70)	1.234 (31.24)	.969 (24.61)	.125 (3.18)
18	1.126 (28.60)	1.183 (30.05)	1.034 (31.34)	1.233 (31.32)	.152 (3.86)	.185 (4.70)	1.328 (33.73)	1.062 (26.97)	.125 (3.18)
20	1.251 (31.77)	1.308 (33.22)	1.158 (34.52)	1.358 (34.49)	.179 (4.55)	.185 (4.70)	1.453 (36.91)	1.156 (29.36)	.125 (3.18)
22	1.376 (34.95)	1.433 (36.40)	1.283 (32.59)	1.483 (37.67)	.179 (4.55)	.185 (4.70)	1.578 (40.08)	1.250 (31.75)	.125 (3.18)
24	1.501 (38.13)	1.568 (39.83)	1.408 (35.76)	1.610 (40.89)	.169 (4.29)	.185 (4.70)	1.703 (43.66)	1.375 (34.92)	.152 (3.86)

Box Mounting Receptacle (Back Panel)

No MS part number

KJ5R

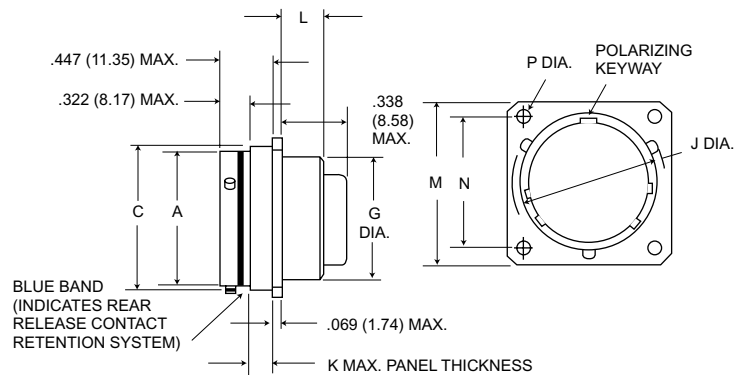

NOTE: This connector does not accommodate backshells

Shell Size	A Dia. Max.	C Dia. Max.	G Dia. Max.	J Dia. Max.	K Max.	L Max.	M Max.	N T.P.	P +.005 (0.13) - .010 (0.25)
8	.474 (12.04)	.522 (13.26)	.421 (10.69)	.563 (14.30)	.147 (3.73)	.185 (4.70)	.828 (21.03)	.594 (15.09)	.125 (3.18)
10	.591 (15.01)	.639 (16.23)	.542 (13.77)	.680 (17.27)	.152 (3.86)	.185 (4.70)	.954 (24.23)	.719 (18.26)	.125 (3.18)
12	.751 (19.08)	.808 (20.52)	.667 (16.94)	.859 (21.82)	.152 (3.86)	.185 (4.70)	1.047 (26.59)	.812 (20.62)	.125 (3.18)
14	.876 (22.25)	.935 (23.75)	.791 (20.09)	.984 (24.99)	.152 (3.86)	.185 (4.70)	1.141 (28.98)	.906 (23.01)	.125 (3.18)
16	1.001 (25.42)	1.058 (26.87)	.916 (23.27)	1.108 (28.14)	.152 (3.86)	.185 (4.70)	1.234 (31.24)	.969 (24.61)	.125 (3.18)
18	1.126 (28.60)	1.183 (30.05)	1.034 (31.34)	1.233 (31.32)	.152 (3.86)	.185 (4.70)	1.328 (33.73)	1.062 (26.97)	.125 (3.18)
20	1.251 (31.77)	1.308 (33.22)	1.158 (34.52)	1.358 (34.49)	.179 (4.55)	.185 (4.70)	1.453 (36.91)	1.156 (29.36)	.125 (3.18)
22	1.376 (34.95)	1.433 (36.40)	1.283 (32.59)	1.483 (37.67)	.179 (4.55)	.185 (4.70)	1.578 (40.08)	1.250 (31.75)	.125 (3.18)
24	1.501 (38.13)	1.568 (39.83)	1.408 (35.76)	1.610 (40.89)	.169 (4.29)	.185 (4.70)	1.703 (43.66)	1.375 (34.92)	.152 (3.86)

Performance Specifications - Pages 115-116

Contacts, Sealing Plugs, Assembly Tools - Pages 134, 136 - 137

Contact Arrangements - Pages 132 - 133

Straight Plug

MS27473
(MS service class E, P, T)

KJ6

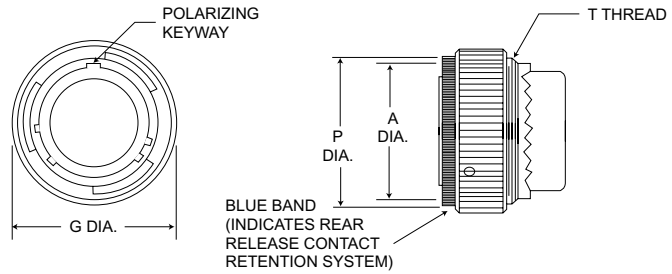

NOTE: For backshell dimensions and configurations, see pages 135 and 136.

Shell Size	A Dia. Max.	G Dia. Max.	P Dia. Max.	T Thread	Overall Length With Backshells		
					E Straight	F Cable Clamp	P Potting Max.
8	.485 (12.32)	.749 (19.02)	.630 (16.00)	7/16-28UNEF-2A	1.026 (26.06)	1.555 (39.50)	1.020 (25.91)
10	.606 (15.39)	.858 (21.79)	.752 (19.10)	9/16-24UNEF-2A	1.026 (26.06)	1.555 (39.50)	1.020 (25.91)
12	.765 (19.43)	1.030 (26.16)	.925 (23.50)	11/16-24UNEF-2A	1.026 (26.06)	1.555 (39.50)	1.020 (25.91)
14	.890 (22.61)	1.155 (29.34)	1.050 (26.67)	13/16-20UNEF-2A	1.026 (26.06)	1.790 (45.47)	1.020 (25.91)
16	1.014 (25.76)	1.280 (32.51)	1.172 (29.77)	15/16-20UNEF-2A	1.026 (26.06)	1.790 (45.47)	1.020 (25.91)
18	1.140 (28.96)	1.405 (35.69)	1.304 (33.12)	1-1/16-18UNEF-2A	1.026 (26.06)	1.790 (45.47)	1.020 (25.91)
20	1.264 (32.11)	1.530 (38.86)	1.435 (36.45)	1-3/16-18UNEF-2A	1.026 (26.06)	1.790 (45.47)	1.020 (25.91)
22	1.389 (35.28)	1.640 (40.66)	1.560 (39.62)	1-5/16-18UNEF-2A	1.026 (26.06)	1.930 (49.02)	1.020 (25.91)
24	1.514 (38.46)	1.765 (44.83)	1.688 (42.88)	1-7/16-18UNEF-2A	1.104 (28.04)	1.930 (49.02)	1.080 (27.43)

Straight Plug Grounded

MS27484
(MS service class E, P, T)

KJG6

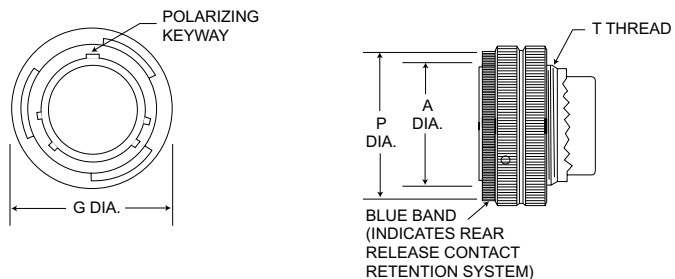

NOTE: For backshell dimensions and configurations, see pages 135 and 136.

Shell Size	A Dia. Max.	G Dia. Max.	P Dia. Max.	T Thread	Overall Length With Backshells		
					E Straight	F Cable Clamp	P Potting Max.
8	.485 (12.32)	.749 (19.02)	.630 (16.00)	7/16-28UNEF-2A	1.026 (26.06)	1.555 (39.50)	1.020 (25.91)
10	.606 (15.39)	.858 (21.79)	.752 (19.10)	9/16-24UNEF-2A	1.026 (26.06)	1.555 (39.50)	1.020 (25.91)
12	.765 (19.43)	1.030 (26.16)	.925 (23.50)	11/16-24UNEF-2A	1.026 (26.06)	1.555 (39.50)	1.020 (25.91)
14	.890 (22.61)	1.155 (29.34)	1.050 (26.67)	13/16-20UNEF-2A	1.026 (26.06)	1.790 (45.47)	1.020 (25.91)
16	1.014 (25.76)	1.280 (32.51)	1.172 (29.77)	15/16-20UNEF-2A	1.026 (26.06)	1.790 (45.47)	1.020 (25.91)
18	1.140 (28.96)	1.405 (35.69)	1.304 (33.12)	1-1/16-18UNEF-2A	1.026 (26.06)	1.790 (45.47)	1.020 (25.91)
20	1.264 (32.11)	1.530 (38.86)	1.435 (36.45)	1-3/16-18UNEF-2A	1.026 (26.06)	1.790 (45.47)	1.020 (25.91)
22	1.389 (35.28)	1.640 (40.66)	1.560 (39.62)	1-5/16-18UNEF-2A	1.026 (26.06)	1.930 (49.02)	1.020 (25.91)
24	1.514 (38.46)	1.765 (44.83)	1.688 (42.88)	1-7/16-18UNEF-2A	1.104 (28.04)	1.930 (49.02)	1.080 (27.43)

Performance Specifications - Pages 115-116

Contacts, Sealing Plugs, Assembly Tools - Pages 134, 136 - 137

Contact Arrangements - Pages 132 - 133



Dimensions are shown in inches (millimeters).
Dimensions subject to change.

www.ittcannon.com

Straight Plug

MS27474
(MS service class E, P, T)

KJ7

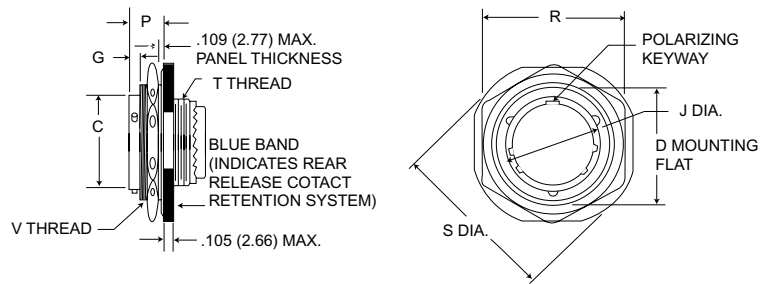

NOTE: For backshell dimensions and configurations, see pages 135 and 136.

Shell Size	C Dia. Max.	D Max.	G Max.	J Max.	P Max.	R Max. Hex.	S Dia. Max.	T Thread	V Thread	Overall length With Backshells		
										E Straight	F Cable Clamp	P Potting Max.
8	.474 (12.04)	.818 (20.78)	.145 (3.68)	.563 (14.30)	.443 (11.25)	1.079 (27.41)	1.381 (35.08)	7/16-28UNEF-2A	7/8-20UNEF-2A	.840 (21.34)	1.555 (39.50)	1.020 (25.91)
10	.591 (15.01)	.942 (23.93)	.145 (3.68)	.680 (17.27)	.443 (11.25)	1.205 (30.61)	1.506 (38.25)	9/16-24UNEF-2A	1-20UNEF-2A	.840 (21.34)	1.555 (39.50)	1.020 (25.91)
12	.751 (19.08)	1.066 (27.08)	.145 (3.68)	.859 (21.82)	.443 (11.25)	1.329 (33.76)	1.631 (41.43)	11/16-24UNEF-2A	1-1/8-18UNEF-2A	.840 (21.34)	1.555 (39.50)	1.020 (25.91)
14	.876 (22.25)	1.191 (30.25)	.145 (3.68)	.984 (24.99)	.443 (11.25)	1.455 (36.96)	1.756 (44.60)	13/16-20UNEF-2A	1-1/4-18UNEF-2A	.840 (21.34)	1.790 (45.47)	1.020 (25.91)
16	1.001 (25.43)	1.321 (33.55)	.145 (3.68)	1.108 (28.14)	.443 (11.25)	1.579 (40.11)	1.944 (49.38)	1-15/16-20UNEF-2A	1-3/8-18UNEF-2A	.840 (21.34)	1.790 (45.47)	1.020 (25.91)
18	1.126 (28.60)	1.441 (36.60)	.145 (3.68)	1.233 (31.32)	.443 (11.25)	1.705 (43.31)	2.022 (51.36)	1-1/16-18UNEF-2A	1-1/2-18UNEF-2A	.840 (21.34)	1.790 (45.47)	1.020 (25.91)
20	1.251 (31.78)	1.566 (39.78)	.171 (4.34)	1.358 (34.49)	.469 (11.91)	1.829 (46.46)	2.147 (54.53)	1-3/16-18UNEF-2A	1-5/8-18UNEF-2A	.840 (21.34)	1.790 (45.47)	1.020 (25.91)
22	1.376 (33.95)	1.691 (42.95)	.171 (4.34)	1.483 (37.67)	.469 (11.91)	2.017 (51.23)	2.271 (57.68)	1-5/16-18UNEF-2A	1-3/4-18UNEF-2A	.840 (21.34)	1.930 (49.02)	1.020 (25.91)
24	1.501 (38.13)	1.816 (46.13)	.171 (4.34)	1.610 (40.89)	.469 (11.91)	2.142 (54.41)	2.396 (60.86)	1-7/16-18UNEF-2A	1-7/8-18UNEF-2A	.860 (21.84)	1.900 (48.26)	1.080 (27.43)

Performance Specifications - Pages 115-116

Contacts, Sealing Plugs, Assembly Tools - Pages 134, 136 - 137

Contact Arrangements - Pages 132 - 133

Panel Cutouts

Flange Mounted Receptacle

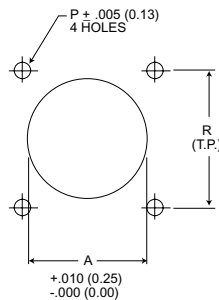

Jam Nut Receptacle

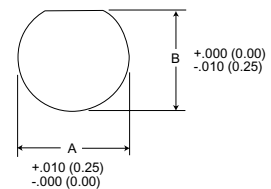

Shell Size	A Dia.	P Dia.	R	Mfg. Screw
8	.610 (15.49)	.125 (3.18)	.594 (15.09)	#4
10	.734 (18.64)	.125 (3.18)	.719 (18.26)	#4
12	.860 (21.84)	.125 (3.18)	.812 (20.62)	#4
14	.985 (25.02)	.125 (3.18)	.906 (23.01)	#4
16	1.110 (28.19)	.125 (3.18)	.969 (24.61)	#4
18	1.234 (31.34)	.125 (3.18)	1.062 (26.97)	#4
20	1.360 (35.54)	.125 (3.18)	1.156 (29.36)	#4
22	1.484 (37.69)	.125 (3.18)	1.250 (31.75)	#4
24	1.611 (40.92)	.152 (3.86)	1.375 (34.93)	#6

Shell Size	A Dia.	B Dia.
8	.885 (22.48)	.830 (21.08)
10	1.010 (25.65)	.955 (24.26)
12	1.135 (28.82)	1.085 (27.56)
14	1.260 (32.00)	1.210 (30.73)
16	1.385 (35.18)	1.335 (33.91)
18	1.510 (38.35)	1.460 (37.08)
20	1.635 (41.53)	1.585 (40.26)
22	1.760 (44.70)	1.710 (43.43)
24	1.885 (47.88)	1.835 (46.61)

How To Order

Military Nomenclature

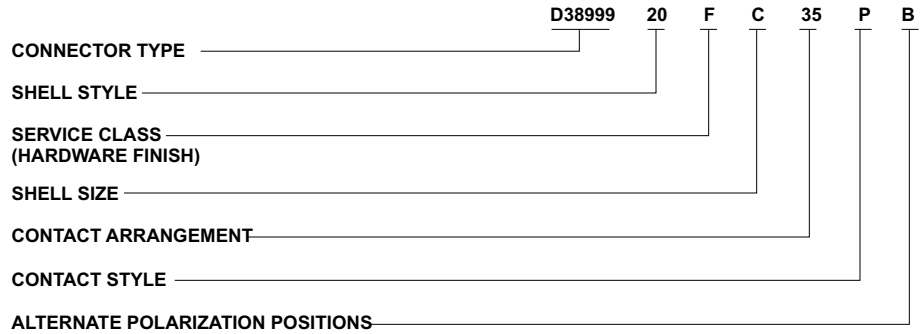

CONNECTOR TYPE
D38999/ - MIL-C-38999 Series III

SHELL STYLE
D38999/20 - Wall mount receptacle
D38999/24 - Jam nut receptacle
D38999/26 - Straight Plug, Grounded

SERVICE CLASS
(Hardware Finish)
F - Electroless nickel - 85°F to +392°F (-65°C to +200°C)
W - Olive drab cadmium over electroless nickel plate, -85°F to +347°F (-65°C to +175°C)

SHELL SIZE

A	B	C	D	E	F	G	H	J	Military Designation
9	11	13	15	17	19	21	23	25	Cannon Designation

CONTACT ARRANGEMENTS
See pages 132 and 133.

CONTACT STYLE
P - Pin contacts
S - Socket contact
A - Less Pin contacts
B - Less Socket contact*

See pages 296-298 for Fiber Optic Contacts.

* Used only when other than power contacts are to be installed (i.e., shielded, thermocouple, etc.)

ALTERNATE POSITIONS
N (normal), A, B, C, D, E. See page 131.

Note: To order MS connectors less standard power contacts, purchase order must state "Less Contacts".

ITT Cannon Nomenclature

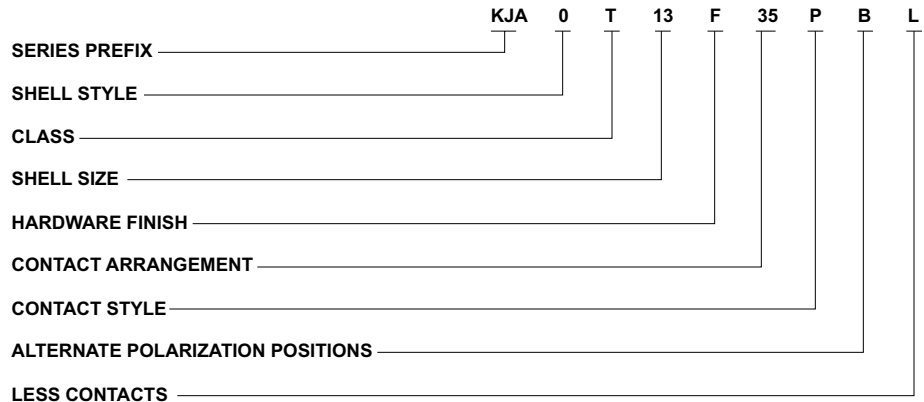

SERIES PREFIX
KJA - Series III - Scoop proof, threaded coupling

SHELL STYLE
0 - Wall mount receptacle
6 - Straight plug
7 - Jam nut receptacle

CLASS
T - Environment-resistant (without rear accessory)

SHELL SIZE

9	11	13	15	17	19	21	23	25	Cannon Designation
A	B	C	D	E	F	G	H	J	Military Designation

HARDWARE FINISH
F - Electroless nickel - 85°F to +392°F (-65°C to +200°C)
W - Olive drab cadmium over electroless nickel plate, -85°F to +347°F (-65°C to +175°C)

CONTACT ARRANGEMENTS
See pages 132 and 133.

CONTACT STYLE
P - Pin contacts
S - Socket contacts

See pages 296-298 for Fiber Optic Contacts

ALTERNATE POLARIZATION POSITIONS
N (normal) A, B, C, D, E. See page 131.

LESS CONTACTS
Use "L" when connectors are ordered less contacts, sealing plugs and insertion/extraction tool. ("L" is not stamped on connectors.)

Wall Mount Receptacle

D38999/20

KJA0T**

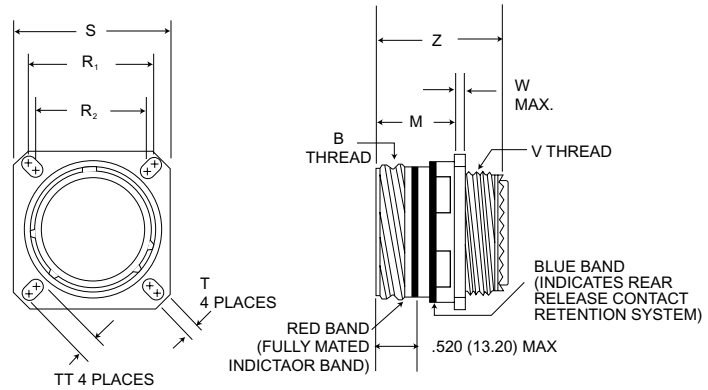

Shell Size	MS Shell size Code	B Thread Class 2A (Plated)	M +.000 (.000) -.005 (.130)	R ₁	R ₂	S ±.012 (.300)	T +.004 (.100) -.002 (.050)	TT +.004 (.100) -.002 (.050)	Metric V Thread (Plated)	W Max.	Z +.005 (.130) -.010 (.250)
9	A	.6250-0.1P-0.3L-TS	.820 (20.83)	.719 (18.26)	.594 (15.09)	.938 (23.83)	.128 (3.25)	.216 (5.49)	M12X1-6g0.100R	.098 (2.50)	1.235 (31.36)
11	B	.7500-0.1P-0.3L-TS	.820 (20.83)	.812 (20.62)	.719 (18.26)	1.031 (26.19)	.128 (3.25)	.194 (4.93)	M15X1-6g0.100R	.098 (2.50)	1.235 (31.36)
13	C	.8750-0.1P-0.3L-TS	.820 (20.83)	.906 (23.01)	.812 (20.62)	1.125 (28.58)	.128 (3.25)	.194 (4.93)	M18X1-6g0.100R	.098 (2.50)	1.235 (31.36)
15	D	1.0000-0.1P-0.3L-TS	.820 (20.83)	.969 (24.61)	.906 (23.01)	1.219 (30.96)	.128 (3.25)	.173 (4.39)	M22X1-6g0.100R	.098 (2.50)	1.235 (31.36)
17	E	1.1875-0.1P-0.3L-TS	.820 (20.83)	1.062 (26.97)	.969 (24.61)	1.312 (33.32)	.128 (3.25)	.194 (4.93)	M25X1-6g0.100R	.098 (2.50)	1.235 (31.36)
19	F	1.2500-0.1P-0.3L-TS	.820 (20.83)	1.156 (29.36)	1.062 (26.97)	1.438 (36.53)	.128 (3.25)	.194 (4.93)	M28X1-6g0.100R	.098 (2.50)	1.235 (31.36)
21	G	1.3750-0.1P-0.3L-TS	.790 (20.07)	1.250 (31.75)	1.156 (29.36)	1.562 (39.67)	.128 (3.25)	.194 (4.93)	M31X1-6g0.100R	.126 (3.20)	1.235 (31.36)
23	H	1.5000-0.1P-0.3L-TS	.790 (20.07)	1.375 (34.92)	1.250 (31.75)	1.688 (42.88)	.154 (3.91)	.242 (6.15)	M34X1-6g0.100R	.126 (3.20)	1.235 (31.36)
25	J	1.6250-0.1P-0.3L-TS	.790 (20.07)	1.500 (38.10)	1.375 (34.92)	1.812 (46.02)	.154 (3.91)	.242 (6.15)	M37X1-6g0.100R	.126 (3.20)	1.235 (31.36)

Straight Plug Grounded

D38999/26

KJA6T**

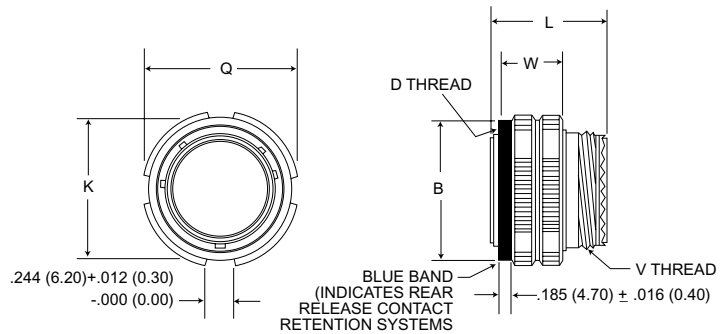

Shell Size	MS Shell size Code	B +.008 (.200) -.000 (.000)	D Thread Class 2B (Plated)	K Max.	L Max.	Q Dia Max.	Metric V Thread (Plated)	W +.008 (.200) -.004 (.100)
9	A	.724 (18.40)	.6250-0.1P-0.3L-TS	.748 (19.00)	1.234 (31.34)	.859 (21.82)	M12X1-6g0.100R	.760 (19.30)
11	B	.831 (21.10)	.7500-0.1P-0.3L-TS	.862 (21.90)	1.234 (31.34)	.969 (24.61)	M15X1-6g0.100R	.760 (19.30)
13	C	1.000 (25.40)	.8750-0.1P-0.3L-TS	1.027 (26.10)	1.234 (31.34)	1.141 (28.98)	M18X1-6g0.100R	.760 (19.30)
15	D	1.130 (28.70)	1.0000-0.1P-0.3L-TS	1.153 (29.30)	1.234 (31.34)	1.266 (32.16)	M22X1-6g0.100R	.760 (19.30)
17	E	1.268 (32.20)	1.1845-0.1P-0.3L-TS	1.291 (32.80)	1.234 (31.34)	1.391 (35.53)	M25X1-6g0.100R	.760 (19.30)
19	F	1.374 (34.90)	1.2500-0.1P-0.3L-TS	1.398 (35.50)	1.234 (31.34)	1.500 (38.10)	M28X1-6g0.100R	.760 (19.30)
21	G	1.500 (38.10)	1.3750-0.1P-0.3L-TS	1.524 (38.70)	1.234 (31.34)	1.625 (41.28)	M31X1-6g0.100R	.760 (19.30)
23	H	1.618 (41.40)	1.5000-0.1P-0.3L-TS	1.642 (41.70)	1.234 (31.34)	1.750 (44.45)	M34X1-6g0.100R	.760 (19.30)
25	J	1.744 (44.30)	1.6250-0.1P-0.3L-TS	1.768 (44.90)	1.234 (31.34)	1.875 (47.62)	M37X1-6g0.100R	.760 (19.30)

Performance Specifications - Pages 115-116

Contacts, Sealing Plugs, Assembly Tools - Pages 134, 136-137

Contact Arrangements - Pages 132 - 133

Jam Nut Receptacle

D38999/24

KJA7T***

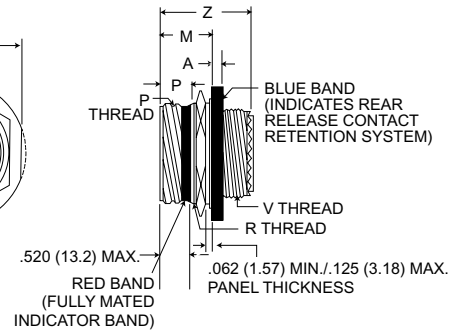
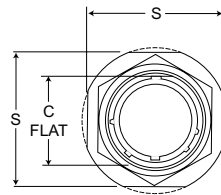

Shell Size	MS Shell size Code	A +.010 (.250) -.005 (.130)	B Thread Class 2A (Plated)	C +.004 (.100) -.010 (.250)	Z +.005 (.130) -.040 (.100)	M +.005 (.130) -.004 (.100)	P +.016 (.410) -.004 (.100)	S	Metric R Thread (Plated)	Metric V Thread (Plated)
9	A	.104 (2.64)	.6250-0.1P-0.3L-TS	.651 (16.53)	1.243 (31.57)	.871 (22.12)	.555 (14.10)	1.062 (26.97)	M17X1-6g0.100R	M12X1-6g0.100R
11	B	.104 (2.64)	.7500-0.1P-0.3L-TS	.751 (19.07)	1.243 (31.57)	.871 (22.12)	.555 (14.10)	1.250 (31.75)	M20X1-6g0.100R	M15X1-6g0.100R
13	C	.104 (2.64)	.8750-0.1P-0.3L-TS	.938 (23.82)	1.243 (31.57)	.878 (22.30)	.563 (14.30)	1.375 (34.92)	M25X1-6g0.100R	M18X1-6g0.100R
15	D	.104 (2.64)	1.0000-0.1P-0.3L-TS	1.062 (26.97)	1.243 (31.57)	.878 (22.30)	.563 (14.30)	1.500 (38.10)	M28X1-6g0.100R	M22X1-6g0.100R
17	E	.104 (2.64)	1.1875-0.1P-0.3L-TS	1.187 (30.15)	1.243 (31.57)	.878 (22.30)	.563 (14.30)	1.625 (41.28)	M32X1-6g0.100R	M25X1-6g0.100R
19	F	.135 (3.43)	1.2500-0.1P-0.3L-TS	1.312 (33.32)	1.243 (31.57)	.878 (22.30)	.563 (14.30)	1.812 (46.02)	M35X1-6g0.100R	M28X1-6g0.100R
21	G	.135 (3.43)	1.3750-0.1P-0.3L-TS	1.437 (36.50)	1.243 (31.57)	.878 (22.30)	.563 (14.30)	1.938 (49.23)	M38X1-6g0.100R	M31X1-6g0.100R
23	H	.135 (3.43)	1.5000-0.1P-0.3L-TS	1.562 (39.67)	1.243 (31.57)	.878 (22.30)	.563 (14.30)	2.062 (52.37)	M41X1-6g0.100R	M34X1-6g0.100R
25	J	.135 (3.43)	1.6250-0.1P-0.3L-TS	1.687 (42.85)	1.243 (31.57)	.878 (22.30)	.563 (14.30)	2.188 (55.38)	M44X1-6g0.100R	M37X1-6g0.100R

Performance Specifications - Pages 115-116

Contacts, Sealing Plugs, Assembly Tools - Pages 134, 136-137

Contact Arrangements - Pages 132 - 133

Panel Cutouts

Wall Mounted Receptacle

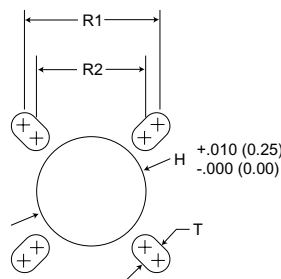

Jam Nut Receptacle

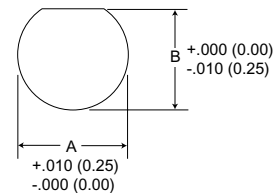

Shell Size	A	B	H	R1 (TP)	R2 (TP)	T (Max.)
9	.700 (17.78)	.670 (17.02)	.626 (15.90)	.719 (18.26)	.594 (15.09)	.134 (3.40)
11	.825 (20.26)	.770 (19.59)	.751 (19.08)	.812 (20.62)	.719 (18.26)	.134 (3.40)
13	1.01 (25.65)	.955 (24.26)	.876 (22.25)	.906 (23.01)	.812 (20.62)	.134 (3.40)
15	1.135 (28.83)	1.085 (27.56)	1.001 (24.43)	.969 (24.61)	.906 (23.01)	.134 (3.40)
17	1.260 (32.01)	1.210 (30.73)	1.188 (30.18)	1.062 (26.97)	.969 (24.61)	.134 (3.40)
19	1.385 (35.18)	1.335 (33.91)	1.251 (31.78)	1.156 (29.36)	1.062 (26.97)	.134 (3.40)
21	1.510 (38.35)	1.460 (37.08)	1.376 (34.95)	1.250 (31.75)	1.156 (29.36)	.134 (3.40)
23	1.635 (41.53)	1.585 (40.26)	1.511 (38.38)	1.375 (34.92)	1.250 (31.75)	.160 (4.06)
25	1.760 (44.70)	1.710 (43.43)	1.626 (41.30)	1.500 (38.10)	1.375 (34.92)	.160 (4.06)

Polarizing Positions

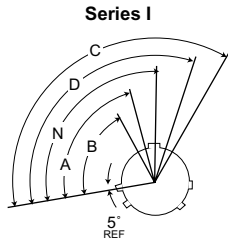

Front face of receptacle (plug opposite). Insert arrangement does not rotate with main key-keyway. The master key is rotated to provide shell polarization; the minor keys remain fixed.

Shell Size	Angle of Rotation (Degrees)				
	Normal	A	B	C	D
9	95°	77°	-	-	113°
11	95°	81°	67°	123°	109°
13	95°	75°	63°	127°	115°
15	95°	74°	61°	129°	116°
17	95°	77°	65°	125°	113°
19	95°	77°	65°	125°	113°
21	95°	77°	65°	125°	113°
23	95°	80°	69°	121°	110°
25	95°	80°	69°	121°	110°

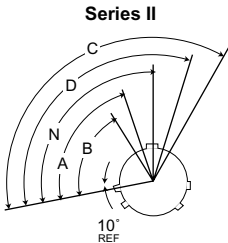

Front face of receptacle (plug opposite). Insert arrangement does not rotate with main key-keyway. The master key is rotated to provide shell polarization; the minor keys remain fixed.

Shell Size	Angle of Rotation (Degrees)				
	Normal	A	B	C	D
8	100°	82°	-	-	118°
10	100°	86°	72°	128°	114°
12	100°	80°	68°	132°	120°
14	100°	79°	66°	134°	121°
16	100°	82°	70°	130°	118°
18	100°	82°	70°	130°	118°
20	100°	82°	70°	130°	118°
22	100°	85°	74°	126°	115°
24	100°	85°	74°	126°	115°

Series III

RECEPTACLE
(Front face shown)

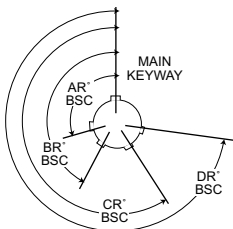

PLUG
(Front face shown)

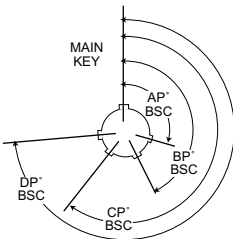

NOTES:

1. All Angles are BSC
2. The insert arrangement does not rotate with main key/keyway
3. All minor keys are rotated to provide shell polarization, the master key remains fixed at twelve o'clock position.
4. Polarization is different from Series I and II.

Shell Size	Key & Keyway Arrangement identification Letter	Key Locations			
		AR ^o or AP ^o BSC	BR ^o or BP ^o BSC	CR ^o or CP ^o BSC	DR ^o or DP ^o BSC
9	N	105	140	215	265
	A	102	132	248	320
	B	80	118	230	312
	C	35	140	205	275
	D	64	155	234	304
11	E	91	131	197	240
	N	95	141	208	236
13	A	113	156	182	292
	B	90	145	195	252
15	C	53	156	220	255
	D	119	146	176	298
17	E	51	141	184	242
	N	80	142	196	293
19	A	135	170	200	310
	B	49	169	200	244
21	C	66	140	200	257
	D	62	145	180	280
23	E	79	153	197	272
	N	80	142	196	293
25	A	135	170	200	310
	B	49	169	200	244
27	C	66	140	200	257
	D	62	145	180	280
29	E	79	153	197	272
	N	80	142	196	293

Contact Arrangements (Engaging View Pin Insert)

* Socket insert only

** Pin insert only (Not available in socket insert Series I and III)

† Indicates layouts are available in all shell styles including MS27499, MS27508, KJ2E and KJ5E

• Consult factory MS27505E/KJL5E insert availability

For "inactive", use - 35 layout.

	Inactive			Inactive								
Series III	-	9-98	9-35	-	11-5	-	11-98	-	11-35	-	13-8	
Series II	8-6†	8-98†	8-35†	-	10-5†	10-13†	10-98†	10-99†	10-35†	12-3	12-4†	
Series I	9-6**	9-98	9-35	11-4	11-5	11-13**	11-98	11-99	11-35	-	13-4**	
No. of Contacts	6 #22M	3 #20	6 #22D	4 #20	5 #20	13 #22M	6 #20	7 #20	13 #22D	3 #16	4 #16	
Service Ratings	M	I	M	I	I	M	I	I	M	II	I	

	Inactive							Inactive		
Series III	13-98	-	13-35	15-5	15-15	15-18	15-19	15-35	-	14-37†
Series II	12-98†	12-22†	12-35†	14-5†	14-15†	14-18†	-	14-35†	15-35	15-37**
Series I	13-98	13-22**	13-35	15-5	15-15	15-18	15-19	15-35	15-35	15-37**
No. of Contacts	10 #20	22 #22M	22 #22D	5 #16	14 #20, 1 #16	18 #20	19 #20	37 #22D	37 #22D	37 #22M
Service Ratings	I	M	M	II	I	I	I	M	M	M

	Inactive		Inactive					Inactive	
Series III	15-97	17-6	17-8	17-26	17-35	-	-	-	-
Series II	14-97†	16-6	16-8†	16-26†	16-35†	16-42†	16-55†	16-99†	16-99†
Series I	15-97	17-6	17-8	17-26	17-35	17-35	17-55**	17-99**	17-99**
No. of Contacts	8 #20, 4 #16	6 #12	8 #16	26 #20	55 #22D	42 #22	55 #22M	21 #20, 2 #16	21 #20, 2 #16
Service Ratings	I	I	II	I	M	M	M	I	I

	Inactive				Inactive	
Series III	18-28	18-30	19-11	19-32	19-35	18-53
Series II	19-28**	19-30**	18-11	18-32†	18-35†	-
Series I	19-28**	19-30**	19-11	19-32	19-35	-
No. of Contacts	26 #20, 2 #16	29 #20, 1 #16	11 #16	32 #20	66 #22D	53 #22
Service Ratings	I	I	II	I	M	M

	Inactive		Inactive		Inactive	
Series III	21-11	21-16	21-35	21-39	21-41	21-41
Series II	20-1†	20-16†	20-35†	20-39†	20-41†	20-41†
Series I	21-1**	21-16	21-35	21-39	21-41	21-41
No. of Contacts	79 #22M	16 #16	79 #22D	37 #20, 2 #16	41- #20	41- #20
Service Ratings	M	II	M	I	I	I

	Inactive		Inactive		Inactive	
Series III	21-75	22-21	23-21	22-32	23-35	23-35
Series II	-	22-21	23-21	22-32	22-35†	22-35†
Series I	21-75*	23-1**	23-2**	23-32**	23-35	23-35
No. of Contacts	4 #8 Twinax	100 #22M	85 #22	32 #20	100 #22D	100 #22D
Service Ratings	M	M	M	I	M	M

Please consult factory for availability of layouts not shown.

Contact Arrangements (Engaging View Pin Insert)

* Socket insert only

** Pin insert only (Not available in socket insert Series I and III)

† Indicates layouts are available in all shell styles including MS27499, MS27508, KJ2E and KJ5E

• Consult factory for MS27505E/KJL5E insert availability for "inactive" layout, use-35.

	Inactive		Inactive		
Series III	23-53	23-55	-	-	25-4
Series II	22-53†	22-55†	24-1†	24-2	24-4†
Series I	23-53	23-55	25-1**	25-2**	25-4
No. of Contacts	53 #20	55 #20	128 #22M	100 #22	48 #20, 8 #16
Service Ratings	I	I	M	M	I
Series III	25-8	25-19	25-20	25-24	25-29
Series II	-	-	-	24-24†	24-29†
Series I	25-8*•	25-19	25-20*•	25-24	25-29
No. of Contacts	8 #8 Coax/Twinax	19 #12	3 #8 Twinax, 13 #16, 4 #12 Coax, 10 #20	12 #16, 12 #12	29 #16
Service Ratings	Coax	I	N	I	I
Series III	25-35	25-37	25-42	25-43	25-46
Series II	24-35†	-	-	-	-
Series I	25-35	25-37*•	25-42*•	25-43	25-46
No. of Contacts	128 #22D	37 #16	38 #20, 4 #8 Coax	23 #20, 20 #16	40 #20, 4 #16, 2 #8 coax
Service Ratings	M	I	I, Coax	I	coax
Series III	25-61	25-64*	25-66*		
Series II	24-61†	-	-		
Series I	25-61	25-64*	25-66*		
No. of Contacts	61 #20	40 #22D, 8 #20, 10 #16, 6 #12	53 #22D, 2 #20, 11 #16		
Service Rating	I	I	I		

Please consult factory for availability of layouts not shown.

Contacts-Pin (Series I/II/III)

MIL-C-39029/58

KJL/KJ/KJA

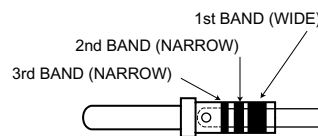

Conact Size	1	Color Bands 2	3	Cannon Part Number	M39029 Military Part Number	Superseded Military Part Number
22D	Orange	Blue	Black	030-2042-000	M39029/58-360	MS27493-22D
*22M	Orange	Blue	Brown	030-1993-022	M39029/58-361	MS27493-22M
*22	Orange	Blue	Red	030-1999-022	M39029/58-362	MS27493-22
20	Orange	Blue	Orange	030-1997-020	M39029/58-363	MS27493-20
16	Orange	Blue	Yellow	030-1995-016	M39029/58-364	MS27493-16
12	Orange	Blue	Green	030-2155-000	M39029/58-365	MS27493-12

*Inactive for new design.

Contacts-Socket (Series II)

MIL-C-39029/57

KJ

Manufacture identification Code Area - Typical all contacts

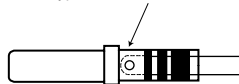

Contact Size	1	Color Bands 2	3	Cannon Part Number	M39029 Military Part Number	Superseded Military Part Number
22D	Orange	Green	Yellow	031-1147-000	M39029/57-354	MS27491-22D
*22M	Orange	Green	Green	031-1122-022	M39029/57-355	MS27491-22M
*22	Orange	Green	Blue	031-1125-022	M39029/57-356	MS27491-22
20	Orange	Green	Violet	031-1124-031	M39029/57-357	MS27491-20
16	Orange	Green	Gray	031-1123-016	M39029/57-358	MS27491-16
12	Orange	Green	White	031-1238-000	M39029/57-359	MS27491-12

*Inactive for new design.

Contacts-Socket (Series I & III)

MIL-C-39029/56

KJL/KJA

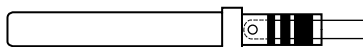

Contact Size	1	Color Bands 2	3	Cannon Part Number	M39029 Military Part Number	Superseded Military Part Number
22D	Orange	Yellow	Gray	031-1147-007	M39029/56-348	MS27490-22D
20	Orange	Green	Brown	031-1250-012	M39029/56-351	MS27490-20
16	Orange	Green	Red	031-1251-001	M39029/56-352	MS27490-16
12	Orange	Green	Orange	031-1237-000	M39029/56-353	MS27490-12

Wire Sizes and Diameters

Wire sizes and diameters

Conact Size	Wire size (AWG)	Finished wire outside dimensions	
		Minimum	Maximum
22D	28, 26, 24, 22	0.030 (0.76)	0.054 (1.37)
22M*	28, 26, 24	0.030 (0.76)	0.050 (1.27)
22*	26, 24, 22	0.034 (0.86)	0.060 (1.52)
20	24, 22, 20	0.040 (1.02)	0.083 (2.11)
16	20, 18, 16	0.065 (1.65)	0.109 (2.77)
12	14, 12	0.097 (2.46)	0.142 (3.61)
8	M17/095-RG-180**	0.135 (3.43)	0.155 (3.94)

*Inactive for new design.

** MIL-C-17

Connectors shall meet the requirements specified when:

- A full complement of wire of the applicable minimum or maximum insulation diameter is installed.
- Any combinations of wire diamters not exceeding dimensions of (a), above can be used.

Note: Contacts for printed circuit and wire wrap applications are also available. Consult ITT Cannon.

Backshell - Type E (Straight), Series II only

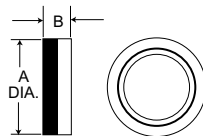

Shell Size		
Series II	A Dia. Max.	B Dia. Max.
8	.580 (14.73)	.328 (8.33)
10	.705 (17.91)	.328 (8.33)
12	.830 (21.08)	.328 (8.33)
14	.955 (24.26)	.328 (8.33)
16	1.080 (27.32)	.328 (8.33)
18	1.205 (30.61)	.328 (8.33)
20	.330 (33.78)	.328 (8.33)
22	1.455 (36.96)	.328 (8.33)
24	1.555 (39.50)	.270 (6.86)

How To Order

Shell Size	Finishes			
	A	B	C	N
Series II	Cadmium/Nickel-Clear Part Number	Cadmium/Nickel-O.D Part Number	Anodic Non-Cond. Part Number	Electroless Nickel Part Number
8	057-0776-000	057-0862-000	057-0819-000	057-0776-002
10	057-0777-000	057-0863-000	057-0820-000	057-0777-002
12	057-0778-000	057-0864-000	057-0821-000	057-0778-002
14	057-0779-000	057-0846-000	057-0822-000	057-0779-002
16	057-0780-000	057-0847-000	057-0823-000	057-0780-002
18	057-0781-000	057-0848-000	057-0824-000	057-0781-002
20	057-0782-000	057-0849-000	057-0825-000	057-0782-002
22	057-0783-000	057-0850-000	057-0826-000	057-0783-002
24	057-0784-000	057-0851-000	057-0827-000	057-0784-002

Backshell - Type F (Cable Clamp)

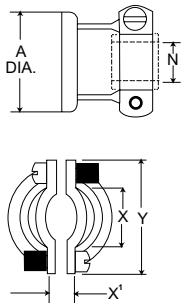

Shell Size						
Series I	Series II	A Max.	N Dia. Max.	X Dia. Min.	X' Dia. Min.	Y Max.
9	8	.508 (14.73)	.135 (3.43)	.234 (5.94)	.187 (4.75)	.829 (21.06)
11	10	.705 (17.91)	.198 (5.03)	.297 (7.54)	.187 (4.75)	.891 (22.63)
13	12	.830 (21.08)	.322 (7.18)	.422 (10.72)	.281 (7.14)	1.016 (25.81)
15	14	.955 (24.26)	.385 (9.78)	.547 (12.89)	.325 (8.26)	1.141 (28.98)
17	16	1.080 (27.43)	.510 (12.95)	.609 (15.47)	.356 (9.04)	1.203 (30.56)
19	18	1.205 (30.61)	.635 (16.13)	.734 (18.64)	.456 (11.58)	1.469 (37.31)
21	20	1.330 (33.78)	.635 (16.13)	.734 (18.64)	.519 (13.18)	1.469 (37.31)
23	22	1.455 (36.96)	.760 (19.30)	.922 (23.42)	.519 (13.18)	1.656 (42.06)
25	24	1.555 (39.50)	.810 (20.57)	.984 (24.99)	.657 (16.69)	1.750 (44.45)

How To Order (MS Version)

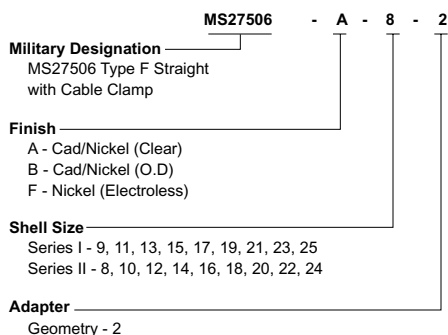

Shell Size		Finishes							
Series I	Series II	MS Part Number	Cannon Part Number	Cannon	A	B	N	F	
					Cannon	MS	Cannon	MS	Cannon
9	8	27506-*8-2	057-3005-***	-012	A	-013	B	-015	F
11	10	27506-*10-2	057-3006-***	-011	A	-012	B	-014	F
13	12	27506-*12-2	057-3007-***	-012	A	-013	B	-015	F
15	14	27506-*14-2	057-3008-***	-010	A	-011	B	-013	F
17	16	27506-*16-2	057-3009-***	-012	A	-013	B	-015	F
19	18	27506-*18-2	057-3010-***	-013	A	-014	B	-016	F
21	20	27506-*20-2	057-3011-***	-011	A	-013	B	-015	F
23	22	27506-*22-2	057-3012-***	-015	A	-016	B	-018	F
25	24	27506-*24-2	057-3013-***	-013	A	-014	B	-017	F

* MS Finish *** Cannon Finish

Backshell - Type P (Potting Boot)

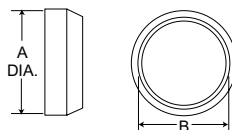

Shell Size			
Series I	Series II	A Dia. Max.	B Dia. Max.
9	8	.598 (15.19)	.434 (11.02)
11	10	.723 (18.36)	.548 (13.92)
13	12	.847 (21.51)	.673 (17.09)
15	14	.969 (24.61)	.798 (20.27)
17	16	1.087 (27.61)	.899 (22.83)
19	18	1.211 (30.76)	1.024 (26.01)
21	20	1.336 (33.93)	1.141 (29.98)
23	22	1.461 (37.11)	1.274 (32.36)
25	24	1.586 (40.28)	1.399 (35.53)

How To Order (MS Version)

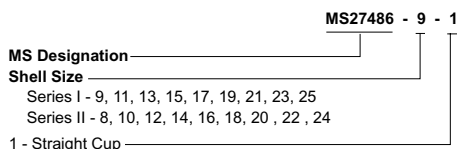

NOTE: When ordering the MS version you must specify both MS numbers for the Potting Boot and the Adapter Ring.

Shell Size		MS27486 Part Number	Cannon Part Number
Series I	Series II		
9	8	27486**-1	040-0185-000
11	10	27486**-1	040-0169-000
13	12	27486**-1	040-0170-000
15	14	27486**-1	040-0171-000
17	16	27486**-1	040-0172-000
19	18	27486**-1	040-0173-000
21	20	27486**-1	040-0174-000
23	22	27486**-1	040-0175-000
25	24	27486**-1	040-0176-000

** Specify applicable Series I or II, shell size.

Adapter Ring

How To Order (MS Version)

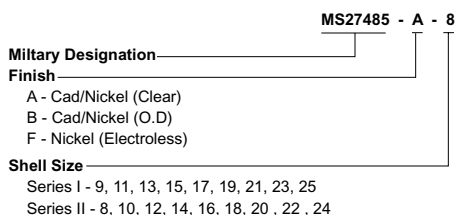

NOTE: When ordering the MS version you must specify both MS numbers for the Potting Boot and the Adapter Ring.

Shell Size				Finishes							
Series I	Series II	MS27485 Part Number	Cannon Part Number	A Cadmium/Nickel-Clear		B Cadmium/Nickel-O.D		N Electroless		F Nickel	
				Cannon	MS	Cannon	MS	Cannon	MS		
9	8	27485-***	237-0887-***	-000	A	-001	B	-002	F		
11	10	27485-***	237-0874-***	-000	A	-001	B	-002	F		
13	12	27485-***	237-0875-***	-000	A	-001	B	-002	F		
15	14	27485-***	237-0876-***	-000	A	-001	B	-002	F		
17	16	27485-***	237-0877-***	-000	A	-001	B	-002	F		
19	18	27485-***	237-0878-***	-000	A	-001	B	-002	F		
21	20	27485-***	237-0879-***	-000	A	-001	B	-002	F		
23	22	27485-***	237-0880-***	-000	A	-001	B	-003	F		
25	24	27485-***	237-0881-***	-000	A	-001	B	-003	F		

* MS Finish

** Specify applicable Series I or II shell size

*** Cannon Finish

Wire Sealing Plugs

Series III Size	Series I & II Size	Part Number		Color Code
		ITT Cannon	MS27488	
22D	22D	225-1013-000	MS27488-22	Black
22M	22M	225-1013-000	MS27488-22	Black
-	22	225-1013-000	MS27488-22	Black
20	20	225-0070-000	MS27488-20	Red
16	16	225-0071-000	MS27488-16	Blue
12	12	225-0072-000	MS27488-12	Yellow

Wire sealing plugs meet MS27488 standards. The plugs are color coded according to size for easy identification. Wire sealing plugs may be ordered separately.

Tools - Crimp

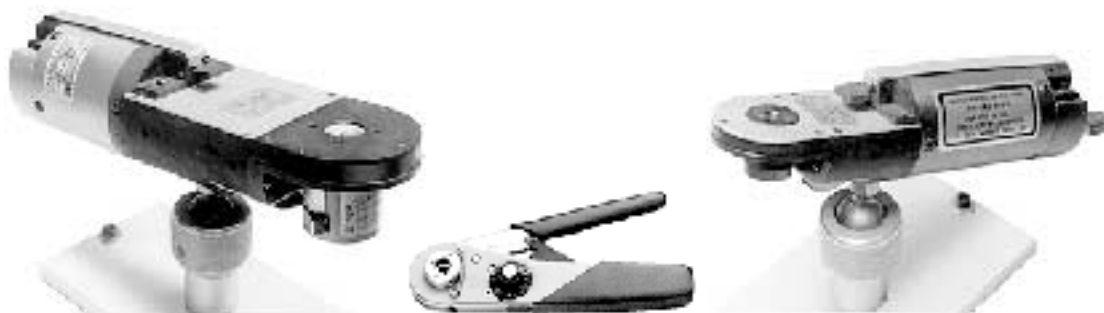

M22520/1-01

CBT-530

M22520/2-01

CBT-565

Contact Size	Pin Contact Series I/II/III		Socket Contact Series II		Socket Contact Series I & III	
	Crimp Tool Part Number	Locator or Turret Part Number	Crimp Tool Part Number	Locator or Turret Part Number	Crimp Tool Part Number	Locator or Turret Part Number
22D or 22M	M22520/2-01	M22520/2-09	M22520/2-01	M22520/2-06	M22520/2-01	M22520/2-07
22	M22520/2-01	M22520/2-09	M22520/2-01	M22520/2-06	M22520/2-01	M22520/2-07
20	M22520/1-01	M22520/1-04 OR TH 187	M22520/1-01	M22520/1-04	M22520/1-01	M22520/1-04
16	M22520/1-01	M22520/1-04 OR TH 187	M22520/1-01	M22520/1-04	M22520/1-01	M22520/1-04
12	M22520/1-01	M22520/1-04	M22520/1-01	M22520/1-04	M22520/1-01	M22520/1-04

Tools - Plastic



Insertion/Extraction

Contact Size	Cannon Description	Cannon Part Number	M81969 Part Number	Superseded Military Part Number	Insertion Color Tip	Extraction Color Tip
22D	CIET-22D-01	274-7048-000	M81969/14-01	MS27534-22D	Green	White
22M	CIET-22D-01	274-7048-000	M81969/14-01	MS27534-22D	Green	White
20	CIET-20-10	274-7001-000	M81969/14-10	MS27534-20	Red	Orange
16	CIET-16-03	274-7002-000	M81969/14-03	MS27534-216	Blue	White
12	CIET-12-04	274-7003-000	M81969/14-04	MS27534-12	Yellow	White

Tools - Metal (MS)



Insertion

Extraction

Contact Size	Insertion			Extraction			
	MS27495 Part Number	ITT CANNON Part Number	Color Band†	MS27495 Part Number	ITT CANNON Part Number	Color Band†	No.2
22D OR 22M*	MS27495 A22M	995-0001-718	Black	MS27495 R22M	995-0001-719	Black	White
22*	MS27495 A22	995-0001-720	Brown	MS27495 R22	995-0001-721	Brown	White
20	MS27495 A20	995-0001-716	Red	MS27495 R20	995-0001-717	Red	White
16	MS27495 A16	995-0001-732	Blue	MS27495 R16	995-0001-731	Blue	White

† Band No. 1 indicates tool size.

Band No. 2 indicates removal tool.

* Replacement only, not recommended for new design.

Wire Stripping

Strip insulation from end of wire to be crimped. (See table for proper stripping dimensions.) Do not cut or damage wire strands.



Wire Size	A
22D or 22M*	.125 (3.18)
20	.188 (4.77)
16	.188 (4.77)
12	.188 (4.77)

* Inactive, not recommended for new design, replacement only.

Contact Crimping

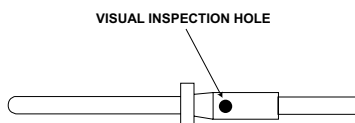

1. Insert stripped wire into contact crimp pot. Wire must be visible thru inspection hole.



2. Using correct crimp tool and locator, cycle the tool once to be sure the indentors are open. Insert contact and wire into locator. Squeeze tool handles firmly and completely to insure a proper crimp. The tool will not release unless the crimp indentors in the tool head have been fully actuated.

3. Release crimped contact and wire from tool. Be certain the wire is visible thru inspection hole in contact.

Contact Insertion



1. Remove hardware from plug or receptacle and slip over wire bundle in proper order for reassembly.



2. Using proper plastic or metal insertion tool for corresponding contact, position wire in tip of the tool so that the tool tip butts up against the contact shoulder.



3. Press tool against contact shoulder and, with firm and even pressure, insert wired contact and tool tip into center contact cavity. A slight click may be heard as metal retaining tines snap into place behind contact shoulder.



4. Remove tool and pull back lightly on wire to make sure contact is properly seated. Repeat operation with remainder of contacts to be inserted, beginning with the center cavity and working outward in alternating rows.



5. After all contacts are inserted, fill any empty cavities with wire sealing plugs, Ressemble plug or receptacle hardware.

Contact Extraction



1. Remove hardware from plug or receptacle and slide hardware back along wire bundle.



2. Using plastic or metal extraction tool with proper color code corresponding to contact size, place wire in tool.



3. Insert tool into contact cavity until tool tip bottoms against the contact shoulder, expanding clip retaining tines.



4. Hold wire firmly in tool and extract wired contact and tool. Repeat operation for all contacts to be extracted.



5. Fill any empty wire cavities with wire sealing plugs, and



6. Reassemble plug or receptacle.

MIL-C-38999 Series I, II, III Connectors

MIL-C-38999 Specifications

The following excerpts are some of the parameter requirements of the MIL-C-3899 Specification.

Test Description	Paragraph Reference	Requirements																																																																								
Contact Retention	4.7.19	<p>After preloading to 3 pounds maximum, the force shall be applied at a rate of approximately 1 pound per second and maintained at full load for 5-10 seconds. No damage to contacts or insert shall result nor shall the contacts be dislocated from their normal position in the connector more than 0.012 inch under the given load. Failure to meet these requirements shall be cause for rejection.</p> <table border="1"> <thead> <tr> <th>Contact Size</th> <th>22M</th> <th>22D</th> <th>22</th> <th>20</th> <th>16</th> </tr> </thead> <tbody> <tr> <td>Loads in Pounds \pm 10%</td> <td>10</td> <td>10</td> <td>10</td> <td>15</td> <td>25</td> </tr> </tbody> </table>	Contact Size	22M	22D	22	20	16	Loads in Pounds \pm 10%	10	10	10	15	25																																																												
Contact Size	22M	22D	22	20	16																																																																					
Loads in Pounds \pm 10%	10	10	10	15	25																																																																					
Coupling Torque	4.7.6	<p>For qualification testing, mating halves shall be coupled and uncoupled, measuring the torques necessary. The torques required to couple and uncouple mating connector halves shall fall within the limits specific as follows:</p> <table border="1"> <thead> <tr> <th colspan="3">Torque lb/in.</th> <th colspan="3">Torque lb/in.</th> <th colspan="3">Torque lb/in.</th> <th colspan="3">Torque lb/in.</th> </tr> <tr> <th>Shell Size</th> <th>Max.</th> <th>Min.</th> <th>Shell Size</th> <th>Max.</th> <th>Min.</th> <th>Shell Size</th> <th>Max.</th> <th>Min.</th> <th>Shell Size</th> <th>Max.</th> <th>Min.</th> </tr> </thead> <tbody> <tr> <td>8/9</td> <td>8</td> <td>2</td> <td>14</td> <td>20</td> <td>4</td> <td>18</td> <td>28</td> <td>5</td> <td>22</td> <td>36</td> <td>7</td> </tr> <tr> <td>10/11</td> <td>12</td> <td>2</td> <td>15</td> <td>20</td> <td>3</td> <td>19</td> <td>28</td> <td>3</td> <td>23</td> <td>36</td> <td>5</td> </tr> <tr> <td>12</td> <td>16</td> <td>2</td> <td>16</td> <td>24</td> <td>4</td> <td>20</td> <td>32</td> <td>6</td> <td>24</td> <td>36</td> <td>7</td> </tr> <tr> <td>13</td> <td>16</td> <td>2</td> <td>17</td> <td>24</td> <td>3</td> <td>21</td> <td>32</td> <td>5</td> <td>25</td> <td>40</td> <td>5</td> </tr> </tbody> </table>	Torque lb/in.			Torque lb/in.			Torque lb/in.			Torque lb/in.			Shell Size	Max.	Min.	Shell Size	Max.	Min.	Shell Size	Max.	Min.	Shell Size	Max.	Min.	8/9	8	2	14	20	4	18	28	5	22	36	7	10/11	12	2	15	20	3	19	28	3	23	36	5	12	16	2	16	24	4	20	32	6	24	36	7	13	16	2	17	24	3	21	32	5	25	40	5
Torque lb/in.			Torque lb/in.			Torque lb/in.			Torque lb/in.																																																																	
Shell Size	Max.	Min.	Shell Size	Max.	Min.	Shell Size	Max.	Min.	Shell Size	Max.	Min.																																																															
8/9	8	2	14	20	4	18	28	5	22	36	7																																																															
10/11	12	2	15	20	3	19	28	3	23	36	5																																																															
12	16	2	16	24	4	20	32	6	24	36	7																																																															
13	16	2	17	24	3	21	32	5	25	40	5																																																															
Durability	4.7.7	Connector halves shall be mated and unmated 250 times for Series II with ground fingers and 500 times for Series I and III at a rate not exceeding 300 cycles per hour. The test may be performed by hand or by mechanical means, but the coupling ring shall be operated as in normal service. Failure to complete this test because of mechanical malfunction shall be cause for rejection.																																																																								
Insulation Resistance	4.7.9	An insulation resistance test shall be performed on unmated connectors in accordance with MIL-STD-202, Method 302, Test condition B. Measurement shall be made between three pairs of adjacent contacts and the shell. Failure to meet the minimum requirement of 50,000 megohms for Classes E, P, F, R, and T shall be cause for rejection.																																																																								
Vibration	4.7.22	Wired, mated connectors shall be subjected to the vibration test of MIL-STD-202, Method 214, Test Condition II, except that the duration shall be one hour in each plane. Receptacles shall be mounted on the vibration fixture by normal means. All contacts shall be wired in a series circuit and 100-500 milliamperes of current shall be allowed to flow through the series circuit during vibration. Suitable means shall be employed to monitor the current flow and to indicate any discontinuity of more than 1 microsecond. The wire bundle shall be damped to the nonvibrating points at least 8 inches from the rear of the connector. Current discontinuity of 1 microsecond or more, disengagement of the mated connectors, evidence of cracking, breaking, or loosening of parts shall be cause for rejection.																																																																								
Shock	4.7.23	Wired mated connectors shall be subjected to one shock in each direction in each of three mutually perpendicular axes. The pulse shall be approximate half sine wave of 300g \pm 15% magnitude with a duration of 3 \pm 1 milliseconds. Receptacles shall be mounted on a shock fixture by normal means. All contacts shall be wired in a series circuit and 100-150 ma. of current shall flow through the series circuit during shock. Suitable means shall be employed to monitor the current flow and to indicate any discontinuity of more than 1 microsecond. The wire bundle shall be clamped to fixed points at least 8 inches from the rear of the connector, Current discontinuity of 1 microsecond or more, disengagement of the mated connectors, evidence of cracking, breaking, or loosening of parts shall be cause for rejection.																																																																								
Thermal Shock	4.7.4	<p>Unmated receptacles shall be subject to 10 cycles of thermal shock in the following manner:</p> <p>Step a. The receptacle shall be suspended for 10 + 1 - 0 minutes in the center of a cold water bath with a volume of approximately one cubic foot. No dimension of the bath shall be less than 10 inches. The water temperature shall not exceed 4°C (20°F)</p> <p>Step b. The receptacle shall be suspended for 10 - 1 - 0 minutes in the center of a hot water bath with a volume of approximately one cubic foot. No dimension of the bath shall be less than 10 inches. The water temperature shall be not less than 94°C (201°F).</p> <p>The time of transfer from one bath to the other shall not exceed 5 seconds. At the end of the tenth cycle, the receptacle shall have the excess moisture shaken off and shall then be dried in a forced air oven at 66\pm5°C for 15 \pm 1 minutes. Any evidence of damage resulting from this test shall be cause for rejection.</p>																																																																								
Altitude Immersion	4.7.8	Mated connectors shall be placed in a container of water at approximately 20°C and placed in an altitude chamber. All wire ends shall be located within the chamber and exposed to the chamber atmosphere, but not submerged. The exposed wire ends shall not be sealed. A quantity of salt, 5 percent by weight, shall be added to make the water conductive. The chamber pressure shall then be reduced to approximately one inch of mercury and maintained for thirty minutes. The chamber pressure shall then be slowly returned to atmospheric. This shall be considered one cycle. Two additional cycles shall be performed. At the end of the last cycle, while the mated connectors are still submerged, the Insulation Resistance Test (room temperature), and the High Potential Test (sea level voltages) shall be performed upon the same circuits. Failure to meet an insulation resistance minimum of 2,000 megohms or any evidence of dielectric breakdown or -flashover shall be cause for rejection.																																																																								
Solvent Immersion	4.7.29	Unmated connectors shall be immersed fully in the applicable fluid specified below for 20 hours. After removal from the fluid, each connector shall remain for one hour in free air at room temperature. a. Jet fuel JP-4 to MIL-J-5624 b. Aircraft lubricating oil to MIL-L-9236																																																																								
Corrosion	4.7.12	Unmated connectors and individual contact samples shall be subjected to the soft spray of MIL-STD-202, Method 101, Test Condition 8 (tin plated, Class Y receptacles-24 hours). Immediately after exposure, the surfaces of the specimens shall be thoroughly washed in tap water and dried in a circulatory oven at a temperature of 38 \pm 3°C (100°F) for a period of approximately 12 hours. Any exposure of basis metal as a result of this test, shall be cause for rejection.																																																																								
Dynamic Salt Spray	4.7.12.2	(Series I and II, finish B; Series III, class W). The wired assembled plugs and receptacles shall be mated and unmated 50 cycles at a rate of 300 cycles per hour maximum. The mating and unmating shall be accomplished so that the plug and receptacle are completely separated during each cycle. The connectors shall then be subjected to the salt spray test in accordance with method 1001 of MIL-STD- 1344. The connectors shall be tested for 452 hours mated followed by 48 hours unmated. After the salt spray exposure the remaining number of durability cycles specified in 4.7.7 shall be completed.																																																																								
Temperature Durability	4.7.33	<p>Wired, mated connectors shall be subjected to the indicated ambient temperature for a period of 1,000 hours.</p> <table border="1"> <tbody> <tr> <td>Series I and II (finish A)</td> <td>150</td> <td>+3° (302°F) -0°C</td> <td>Series I and II (finish B)</td> <td>175</td> <td>+3° (347°F) -0°C</td> </tr> <tr> <td>Series III (class W)</td> <td>175</td> <td>+3° (347°F) -0°C</td> <td>All others finishes</td> <td>200</td> <td>+3° (392°F) -0°C</td> </tr> </tbody> </table>	Series I and II (finish A)	150	+3° (302°F) -0°C	Series I and II (finish B)	175	+3° (347°F) -0°C	Series III (class W)	175	+3° (347°F) -0°C	All others finishes	200	+3° (392°F) -0°C																																																												
Series I and II (finish A)	150	+3° (302°F) -0°C	Series I and II (finish B)	175	+3° (347°F) -0°C																																																																					
Series III (class W)	175	+3° (347°F) -0°C	All others finishes	200	+3° (392°F) -0°C																																																																					



Solder

Crimp

- General purpose
- Closed-entry socket contacts
- Solder termination

KPT connectors are a series of general - purpose, environment - resistant, miniature circular connectors, qualified for use in industrial applications calling for quick - disconnect connectors with fixed contacts for solder termination. These miniature circular connectors are grouped into two series ranging from general purpose solder pot connectors . . . to high performance, crimp connectors . . . to connectors with high contact density. This broad range provides the most complete family of 26482 connectors available today. The versatility of these connectors is proven by the fulfillment of requirements ranging from general purpose to space environmental.

In addition to the two basic series, connectors for special applications are also available. They include RFI filtering versions (with loss pass internal filter pin contacts), hermetic connectors for high pressure watertight requirements, and twist - on pull - off couplers for MIL-C-26482 plugs.

This series is intermateable and intermountable with all MIL-C-26482 connectors, whether solder or crimp type and is available with many materials, finishers and configurations.

How to Order - KPT - Solder Contact Connectors

SERIES PREFIX

- KPT - ITT Cannon prefix
- MS - MIL-C-26482 prefix

SHELL STYLE

- Cannon Designation
- 00 - wall mounting receptacle
- 01 - cable connecting plug
- 02 - box mounting receptacle (Class E only)
- * 03 - wall mounting receptacle without grommet, ferrule and endbell
- * 04 - cable connecting plug without grommet, ferrule and endbell
- * 05 - straight plug without grommet, ferrule, and endbell
- 06 - straight plug
- 07 - jam nut receptacle (available in hermetic version also)
- 08 - 90° angle plug
- B - thru-bulkhead receptacle (Class E only)

* Consult factory for details

SHELL STYLE (cont'd)

- MS Designation
- 3110 - wall mounting receptacle
- 3111 - cable connecting plug
- 3112 - box mounting receptacle (Class E only)
- 3114 - jam nut receptacle
- 3116 - straight plug
- 3119 - thru-bulkhead receptacle (Class E only)

SERIES PREFIX

SHELL STYLE

CLASS

SHELL SIZE

CONTACT ARRANGEMENT

CONTACT STYLE

ALTERNATE INSERT POSITION

MODIFICATION CODE

CLASS

- A - general duty (not MS approved)
- B - general duty with strain relief without grommet & ferrules (may be used for potting when strain relief is desired) (not MS approved)
- E - grommet seal except on 02 and 3112 (MS specification)
- F - grommet seal with strain relief (MS specification)
- J - water tight gland seal with strain relief for jacketed cable (MS specification)
- P - potted (MS specification)

SHELL SIZE

- 8, 10, 12, 14, 16, 18, 20, 22, and 24

MS 3110 E 22-36 P Y
KPT 00 E 22-36 P Y **

CONTACT ARRANGEMENT

See contact arrangement page 149.

CONTACT STYLE

P - pin; S - socket

ALTERNATE INSERT POSITION

W, X, Y and Z. (Omit for normal.)

MODIFICATION CODE

- Omit first (0) of shell style indication when using modifications code.
- 07 - clear chromate over cadmium
- 16 - twist-pull lanyard release coupler (applied cable to plug only).
- 23 - grounding springs fingers (applicable to plug only)

How to Order - KPTB Thru-Bulkhead Receptacle Connectors

- General Purpose
- Double ended pin and socket contacts
- Contains KPT socket insert
- Nonremovable contacts

KPT connectors are a series of general - purpose, miniature circular connectors, qualified for use in military applications. They are also widely used in industrial applications. The KPTB in a thru-bulkhead version with double faced pin and socket insert construction allowing mating from both ends. They contain KPT socket inserts with feed-thru (pin/socket) non-removable contacts.

The thru-bulkhead receptacle is provided for applications requiring the disconnection of a power source from either side of a panel. A typical connector to be used if air leakage requirements are critical.

SERIES PREFIX _____ KPTB 22 - 55 PS Y
SHELL SIZE _____
CONTACT ARRANGEMENT _____
CONTACT STYLE (pin & socket) _____
ALTERNATE INSERT POSITION _____

MIL-C-26482 PREFIX _____ MS3119 E 22 - 55 Y
CLASS _____
SHELL SIZE _____
CONTACT ARRANGEMENT _____
ALTERNATE INSERT POSITION _____

How to Order - KPSE Crimp Contact Connectors

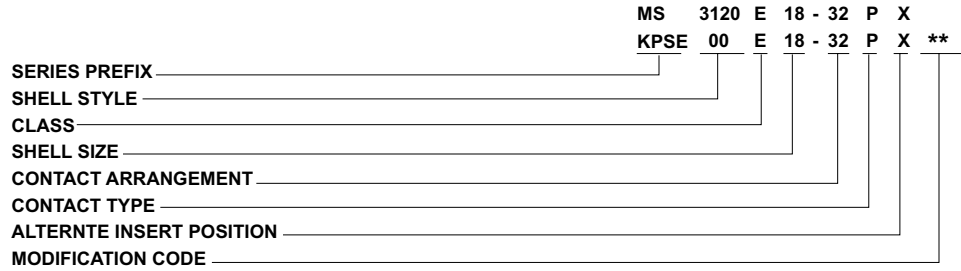

SERIES PREFIX

- KPSE - ITT Cannon prefix
- MS - MIL-C-26482 prefix

SHELL STYLE

- ITT Cannon Number:
- 00 - wall mounting receptacle
- 01 - cable connecting plug
- 02 - box mounting receptacle (without wire seals)
- * 03 - wall mounting receptacle without ferrule and endbell
- * 04 - cable connector plug without ferrule and endbell
- * 05 - straight plug without ferrule and endbell
- 06 - straight plug
- 07 - jam nut receptacle
- 08 - 90° angle plug

* Consult factory for details

MS Designation

- 3120 - wall mounting receptacle
- 3121 - cable connecting plug
- 3122 - box mounting receptacle
- 3124 - jam nut receptacle
- 3126 - straight plug

CLASS

- A - general duty (not MS approved)
- B - general duty with strain relief without grommet & ferrules (not MS approved)
- E - grommet seal (MS specification)
- F - grommet seal with strain relief (MS specification)
- J - gland seal with strain relief for jacketed cable (not MS approved)
- P - potted (MS specification)

SHELL SIZE

- 10, 12, 14, 16, 18, 20, 22, and 24

CONTACT ARRANGEMENT

See contact arrangements page 149.

CONTACT STYLE

- P - pin
- S - socket

ALTERNATE INSERT POSITION

W, X, Y and Z. (Omit for normal.)

MODIFICATION CODE

- Omit first (0) of shell style indication when using modifications code.
- F0 - less contacts, not marked on connectors
- 07 - clear chromate over cadmium
- 16 - twist-pull lanyard release coupler (applied cable to plug only).
- 23 - grounding springs fingers (applicable to plug only)

KPSE High Performance Crimp Contact Connectors

- Environment -resistant
- Voidless integrally molded insulator
- Front-release, crimp snap-in contacts
- Closed entry socket contacts
- 4 moisture seals for complete sealing
- Contact clip protected in hard dielectric
- Positive insert-to-shell mechanical retention

KPSE environment-resistant, miniature circular, quick disconnect connectors, qualified to MIL-C-26482, are designed for the exacting requirements of today's electronic industry. The KPSE features an insulator which is mechanically retained in the shell by a positive, hard plastic-to-metal lock retention augmented by a reliable adhesive bond. Complete moisture sealing is achieved by four seal; shell, peripheral, interfacial and wire seals.

Crimp snap-in contacts are retained in clips that are completely encased in a tough hard dielectric wafer, thus protecting the clips tines from damage. Closed-entry socket contacts facilitate positive mating.

The KPSE series is intermateable, intermountable and interchangeable with all MIL-C-26482 connectors, whether crimp or solder type, and is available with many materials, finishes and configurations.

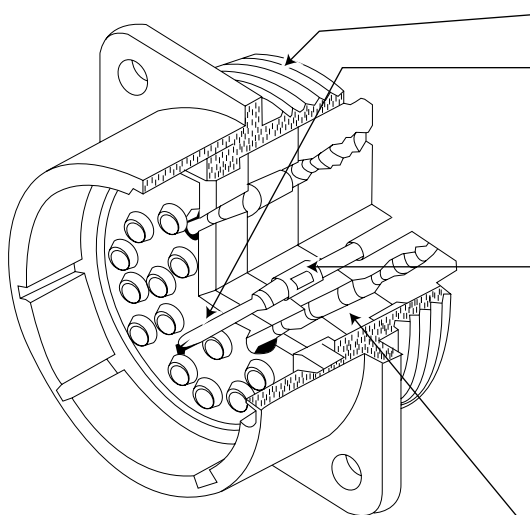

STANDARD MIL-C-26482 HARDWARE mates with any connector designed to MIL-C-26482.

CRIMP, SNAP-IN CONTACTS are designed to MIL-C-39029 and can be crimped with the standard M22520/1 crimp tool.

CLOSED-ENTRY SOCKET CONTACTS eliminate damage from abuse by test probes and help to correct any misaligned pins during engagement. **CONTACT INSERTION** is accomplished from the rear of the connector. When the contact is fully inserted, the clip tines snap securely behind the contact shoulder.

CONTACT EXTRACTION is accomplished with a front-inserted extraction tool. Pressing the tool plunger pushes the contact out thru the rear of the connector.

CONTACT RETAINING CLIP is completely encased in a tough plastic wafer to protect the clip from damage.

COMPLETE MOISTURE SEALING is achieved by combining four seals: shell, peripheral, interfacial and wire seals.

SHELL SEAL is effected when the plug shell pushes against the sealing ring in the receptacle when the connectors are mated.

PERIPHERAL SEAL around the edge of the pin insulator is designed so that mating the connector puts tension on the seal and greatly reduces compression set.

INTERFACIAL SEAL is achieved by the insulator faces meeting when the plug and receptacle are mated.

WIRE SEAL is accomplished by a multiple ripple design, exceeding the wire sealing requirements of MIL-C-26482.

POSITIVE INSERT-TO-SHELL MECHANICAL RETENTION with hard plastic wafer firmly locked into a groove in the shell, in addition to a strong adhesive bond between the insert and shell.

Performance and Material Specifications

STANDARD MATERIALS AND FINISHES

Shell	aluminum alloy, conductive olive drab chromate over cadmium finish per QQ-P-416
Insulator	polychloroprene
Grommet and Seal	polychloroprene
Contacts	Copper alloy, gold plate per MIL-G-45204 type II
Temperature Range	- 55°C to +125°C

MECHANICAL

Shell Sizes	00 - wall mounting receptacle 01 - cable connecting plug 02 - box mounting receptacle 06 - straight plug 07 - jam nut receptacle 08 - 90° angle plug B - thru-bulkhead receptacle (KPT only)
Shell Sizes	KPT 8 thru 24 KPSE 10 thru 24
Polarization/Coupling: five keyway/three point bayonet	
Service Classes	A - general duty B - general duty with strain relief E - grommet seal F - grommet seal with strain relief J - gland nut with strain relief for jacketed cable P - potted

ELECTRICAL

Contact Termination	solder (KPT)		crimp snap-in (KPSE)	
Number of contacts	KPT 2 thru 61		KPSE 3 thru 61	
Wire size, AWG	KPT 12 thru 24		KPSE 16 thru 24	
Wire Range Accommodations		Insulation O.D. Limits		
Contact Size	AWG Wire Size	Min. KPT	Min. KPSE	Max. KPT/ KPSE
20	24, 22 and 20	.060 (1.52)	.047 (1.19)	.083 (2.11)
16	20, 18 and 16	.066 (1.68)	.066 (1.68)	.109 (2.77)
12	14 and 12	.097 (2.46)		.142 (3.61)
Contact Rating	Contact Size	Rated Amps	Test Current	Millivolt Drop
	20	7.5	7.5	less than 55
	16	22.0	13.0	less than 50
Service Rating	Test Volt	Service	AC(rms)	DC
	Sea level	1	1500	2100
		2	2300	3200
	70,000 ft.	1	375	535
		2	550	770
Maximum Operating Voltage	Sea level	1	600	850
		2	1000	1275

Wall Mounting Receptacles

MS3110 (MS service class E, F, J, P)
MS3120 (MS service class E, F, P)

KPT00
KPSE00

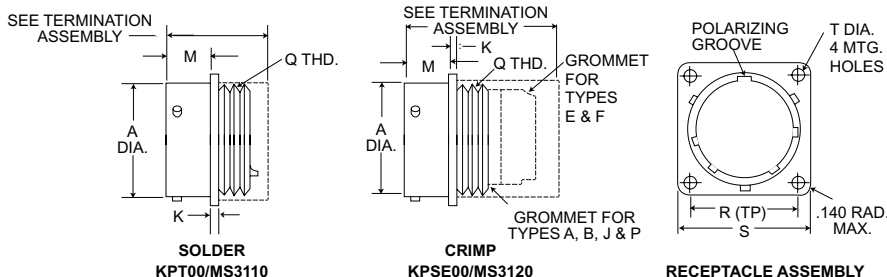

Shell Size	A ± .003 (±.08)	K ± .016 (±.41)	M + .031 (+.79) -.000 (-.00)	R* (TP)	S Max.	T ± .005 (±.13)	Q Thread Class 2A
†8	.471 (11.96)	.062 (1.57)	.431 (10.95)	.594 (15.09)	.828 (21.03)	.120 (3.05)	7/16-28UNEF
10	.588 (14.96)	.062 (1.57)	.431 (10.95)	.719 (18.26)	.954 (24.23)	.120 (3.05)	9/16-24UNEF
12	.748 (19.00)	.062 (1.57)	.431 (10.95)	.812 (20.62)	1.047 (26.59)	.120 (3.05)	11/16-24UNEF
14	.873 (22.17)	.062 (1.57)	.431 (10.95)	.906 (23.01)	1.141 (28.98)	.120 (3.05)	13/16-20UNEF
16	.998 (25.35)	.062 (1.57)	.431 (10.95)	.969 (24.61)	1.234 (31.34)	.120 (3.05)	15/16-20UNEF
18	1.123 (28.52)	.062 (1.57)	.431 (10.95)	1.062 (26.97)	1.328 (33.73)	.120 (3.05)	1-1/16-18UNEF
20	1.248 (31.70)	.094 (2.39)	.556 (14.12)	1.156 (29.36)	1.453 (36.91)	.120 (3.05)	1-3/16-18UNEF
22	1.373 (34.87)	.094 (2.39)	.556 (14.12)	1.250 (31.75)	1.578 (40.08)	.120 (3.05)	1-5/16-18UNEF
24	1.498 (38.05)	.094 (2.39)	.589 (14.96)	1.375 (34.92)	1.703 (43.26)	.147 (3.73)	1-7/16-18UNEF

†Not available in KPSE * (TP) located within .010 T.P. with respect to diameter A and master keyway.

Receptacles with Termination Assemblies

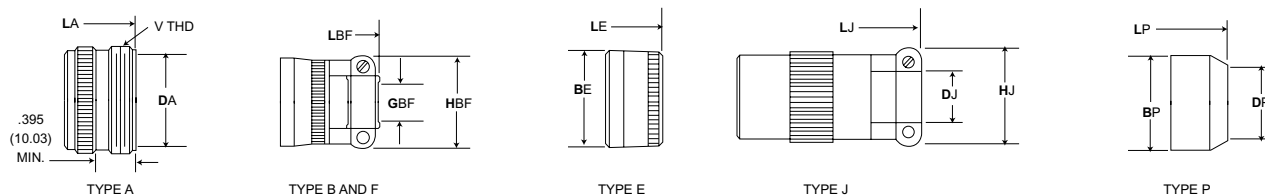

Shell Size	TYPE A			TYPE B and F			TYPE E	
	DA Min.	LA Max.	V Thread Class 2A	GBF Min.	HBF Max.	LBF Max.	BE Max.	LE Max.
†8	.335 (8.15)	1.44 (36.68)	1/2-28UNEF	.115 (2.92)	.828 (21.03)	1.922 (48.82)	.608 (15.44)	1.328 (33.73)
10	.466 (11.84)	1.44 (36.68)	5/8-24UNEF	.178 (4.52)	.891 (22.63)	1.922 (48.82)	.734 (18.64)	1.328 (33.73)
12	.591 (15.01)	1.444 (36.68)	3/4-20UNEF	.302 (7.67)	1.016 (25.81)	1.922 (48.82)	.858 (21.79)	1.328 (33.73)
14	.705 (19.05)	1.444 (36.68)	7/8-20UNEF	.365 (9.27)	1.141 (28.98)	1.922 (48.82)	.984 (24.99)	1.328 (33.73)
16	.830 (21.08)	1.444 (36.68)	1-20UNEF	.490 (12.45)	1.203 (30.56)	2.047 (51.99)	1.110 (28.19)	1.328 (33.73)
18	.948 (24.08)	1.444 (36.68)	1-3/16-18UNEF	.615 (15.62)	1.469 (37.31)	2.078 (52.78)	1.234 (31.34)	1.328 (33.73)
20	1.043 (26.49)	1.728 (43.89)	1-3/16-18UNEF	.615 (15.62)	1.469 (37.31)	2.344 (59.54)	1.360 (34.54)	1.531 (38.89)
22	1.198 (30.43)	1.728 (43.89)	1-7/16-18UNEF	.740 (18.80)	1.656 (42.06)	1.344 (59.54)	1.484 (37.69)	1.531 (38.89)
24	1.293 (32.84)	1.738 (44.15)	1-7/16-18UNEF	.790 (20.07)	1.750 (44.45)	2.406 (61.11)	1.610 (40.89)	1.594 (40.49)

Shell Size	TYPE J			TYPE P		
	DJ Max./Min.	HJ Max.	LJ Max.	BP Max.	DP Min.	LP Max.
†8	.230/.168 (5.84/4.27)	.828 (21.03)	2.271 (57.68)	.608 (15.44)	.317 (8.05)	1.453 (36.91)
10	.312/.205 (7.92/5.21)	.891 (22.63)	2.271 (57.68)	.734 (18.64)	.434 (11.02)	1.453 (36.91)
12	.442/.338 (11.23/8.59)	1.016 (25.81)	2.411 (61.24)	.858 (21.79)	.548 (13.92)	1.453 (36.91)
14	.539/.416 (13.56/10.57)	1.141 (28.98)	2.599 (66.01)	.984 (24.99)	.673 (17.09)	1.453 (36.91)
16	.616/.550 (15.65/13.97)	1.203 (30.56)	2.943 (74.75)	1.110 (28.19)	.798 (20.27)	1.453 (36.91)
18	.672/.600 (17.07/15.24)	1.469 (37.31)	3.172 (80.57)	1.234 (31.34)	.899 (22.83)	1.453 (36.91)
20	.747/.634 (18.97/16.13)	1.469 (37.31)	3.610 (91.69)	1.360 (34.54)	1.024 (26.01)	1.672 (42.47)
22	.846/.670 (21.49/17.02)	1.656 (42.06)	3.766 (95.66)	1.484 (37.69)	1.149 (29.18)	1.672 (42.47)
24	.894/.740 (22.71/18.80)	1.750 (44.45)	3.985 (101.22)	1.610 (40.89)	1.274 (32.36)	1.734 (44.04)

†Not available in KPSE

Performance Specifications - Page 142
Contacts, Sealing Plugs, Assembly Tools - Page 154
Contact Arrangements - Page 149

Cable Connecting Plugs

MS3111
(MS service class E, F, J, P)
MS3121
(MS service class E, F, P)

KPT01
KPSE01

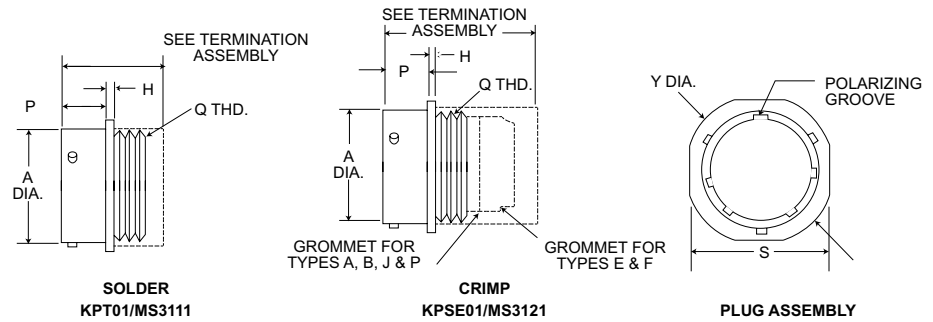

Shell Size	A ± .003 (±.08)	H ± .016 (±.41)	P + .031 (+.79) - .000 (-.00)	S Max.	Y Max.	Q Thread Class 2A
†8	.471 (11.96)	.094 (2.39)	.400 (10.16)	.828 (21.03)	.958 (24.33)	7/16-28UNEF
10	.588 (14.94)	.094 (2.39)	.400 (10.16)	.954 (24.23)	1.082 (27.48)	9/16-24UNEF
12	.748 (19.00)	.094 (2.39)	.400 (10.16)	1.047 (26.59)	1.176 (29.87)	11/16-24UNEF
14	.873 (22.17)	.094 (2.39)	.400 (10.16)	1.141 (28.98)	1.270 (32.26)	13/16-20UNEF
16	.998 (25.35)	.094 (2.39)	.400 (10.16)	1.234 (31.34)	1.364 (34.65)	15/16-20UNEF
18	1.123 (28.52)	.094 (2.39)	.400 (10.16)	1.328 (33.73)	1.458 (37.03)	1-1/16-18UNEF
20	1.248 (31.70)	.115 (2.92)	.535 (13.59)	1.453 (36.91)	1.582 (40.18)	1-3/16-18UNEF
22	1.373 (34.87)	.115 (2.92)	.535 (13.59)	1.578 (40.08)	1.708 (43.38)	1-5/16-18UNEF
24	1.498 (38.05)	.115 (2.92)	.558 (14.43)	1.703 (43.26)	1.832 (46.53)	1-7/16-18UNEF

†Not available in KPSE *(TP) located within .010T.P. with respect to diameters A and master keyway.

Cable Connecting Plugs With Termination Assemblies

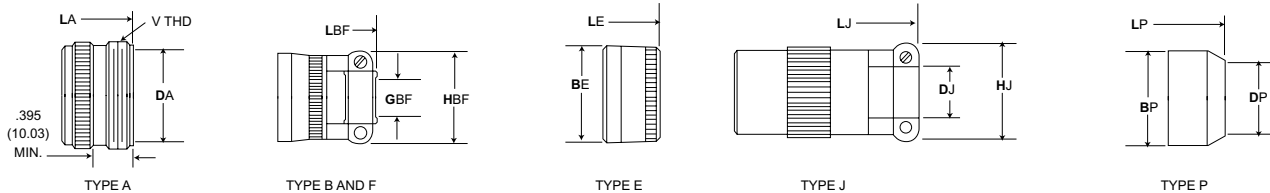

With Termination Assemblies

Shell Size	TYPE A			TYPE B and F			TYPE E	
	DA Min.	LA Max.	V Thread Class 2A	GBF Min.	HBF Max.	LBF Max.	BE Max.	LE Max.
†8	.335 (8.15)	1.44 (36.68)	1/2-28UNEF	.115 (2.92)	.828 (21.03)	1.922 (48.82)	.608 (15.44)	1.328 (33.73)
10	.466 (11.84)	1.44 (36.68)	5/8-24UNEF	.178 (4.52)	.891 (22.63)	1.922 (48.82)	.734 (18.64)	1.328 (33.73)
12	.591 (15.01)	1.44 (36.68)	3/4-20UNEF	.302 (7.67)	1.016 (25.81)	1.922 (48.82)	.858 (21.79)	1.328 (33.73)
14	.705 (19.05)	1.44 (36.68)	7/8-20UNEF	.365 (9.27)	1.141 (28.98)	1.922 (48.82)	.984 (24.99)	1.328 (33.73)
16	.830 (21.08)	1.44 (36.68)	1-20UNEF	.490 (12.45)	1.203 (30.56)	2.047 (51.99)	1.110 (28.19)	1.328 (33.73)
18	.948 (24.08)	1.44 (36.68)	1-3/16-18UNEF	.615 (15.62)	1.469 (37.31)	2.078 (52.78)	1.234 (31.34)	1.328 (33.73)
20	1.043 (26.49)	1.728 (43.89)	1-3/16-18UNEF	.615 (15.62)	1.469 (37.31)	2.344 (59.54)	1.360 (34.54)	1.531 (38.89)
22	1.198 (30.43)	1.728 (43.89)	1-7/16-18UNEF	.740 (18.80)	1.656 (42.06)	1.344 (59.54)	1.484 (37.69)	1.531 (38.89)
24	1.293 (32.84)	1.738 (44.15)	1-7/16-18UNEF	.790 (20.07)	1.750 (44.45)	2.406 (61.11)	1.610 (40.89)	1.594 (40.49)

Shell Size	TYPE J			TYPE P		
	DJ Max./Min.	HJ Max.	LJ Max.	BP Max.	DP Min.	LP Max.
†8	.230/.168 (5.84/4.27)	.828 (21.03)	2.271 (57.68)	.608 (15.44)	.317 (8.05)	1.453 (36.91)
10	.312/.205 (7.92/5.21)	.891 (22.63)	2.271 (57.68)	.734 (18.64)	.434 (11.02)	1.453 (36.91)
12	.442/.338 (11.23/8.59)	1.016 (25.81)	2.411 (61.24)	.858 (21.79)	.548 (13.92)	1.453 (36.91)
14	.539/.416 (13.56/10.57)	1.141 (28.98)	2.599 (66.01)	.984 (24.99)	.673 (17.09)	1.453 (36.91)
16	.616/.550 (15.65/13.97)	1.203 (30.56)	2.943 (74.75)	1.110 (28.19)	.798 (20.27)	1.453 (36.91)
18	.672/.600 (17.07/15.24)	1.469 (37.31)	3.172 (80.57)	1.234 (31.34)	.899 (22.83)	1.453 (36.91)
20	.747/.634 (18.97/16.13)	1.469 (37.31)	3.610 (91.69)	1.360 (34.54)	1.024 (26.01)	1.672 (42.47)
22	.846/.670 (21.49/17.02)	1.656 (42.06)	3.766 (95.66)	1.484 (37.69)	1.149 (29.18)	1.672 (42.47)
24	.894/.740 (22.71/18.80)	1.750 (44.45)	3.985 (101.22)	1.610 (40.89)	1.274 (32.36)	1.734 (44.04)

†Not available in KPSE

Performance Specifications - Page 142
Contacts, Sealing Plugs, Assembly Tools - Page 154
Contact Arrangements - Page 149



Dimensions are shown in inches (millimeters).
Dimensions subject to change.

www.ittcannon.com

Box Mounting Receptacles

MS3112
(MS service class E)
MS3122
(MS service class E)

KPT02
KPSE02

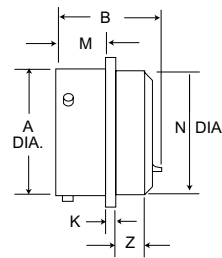

SOLDER
KPT02/MS3112

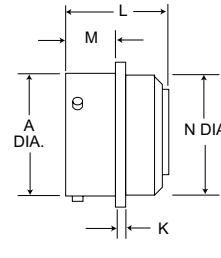

CRIMP
KPSE02/MS3112

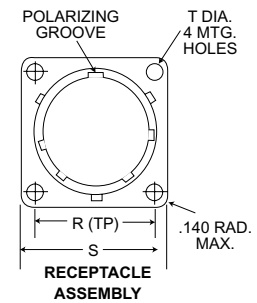

RECEPTACLE
ASSEMBLY

Note: Connector does not accommodate backshell.

Shell Size	A ± .003 (±.08)	B Max	K ± .016 (±.41)	L Max.	M + .031 (+.79) - .000 (-.00)	N Dia. Max.	R* (TP)	S Max.	T ± .005	Z Max.
†8	.471 (11.96)	.978 (12.14)	.062 (1.57)	1.320 (33.07)	.431 (10.95)	.469 (11.91)	.594 (15.09)	.828 (21.03)	.120 (3.05)	.354 (8.99)
10	.588 (14.96)	.978 (12.14)	.062 (1.57)	1.320 (33.07)	.431 (10.95)	.593 (15.06)	.719 (18.26)	.954 (24.23)	.120 (3.05)	.354 (8.99)
12	.748 (19.00)	.978 (12.14)	.062 (1.57)	1.320 (33.07)	.431 (10.95)	.719 (18.26)	.812 (20.62)	1.047 (26.59)	.120 (3.05)	.354 (8.99)
14	.873 (22.17)	.978 (12.14)	.062 (1.57)	1.320 (33.07)	.431 (10.95)	.843 (21.41)	.906 (23.01)	1.141 (28.98)	.120 (3.05)	.354 (8.99)
16	.998 (25.35)	.978 (12.14)	.062 (1.57)	1.320 (33.07)	.431 (10.95)	.969 (24.61)	.969 (24.61)	1.234 (31.34)	.120 (3.05)	.354 (8.99)
18	1.123 (28.52)	.978 (12.14)	.062 (1.57)	1.320 (33.07)	.431 (10.95)	1.093 (27.76)	1.062 (26.97)	1.328 (33.73)	.120 (3.05)	.354 (8.99)
20	1.248 (31.70)	1.196 (30.38)	.094 (2.39)	1.367 (34.72)	.556 (14.12)	1.219 (30.96)	1.156 (29.36)	1.453 (36.91)	.120 (3.05)	.417 (10.59)
22	1.373 (34.87)	1.196 (30.38)	.094 (2.39)	1.367 (34.72)	.556 (14.12)	1.343 (34.11)	1.250 (31.75)	1.578 (40.08)	.120 (3.05)	.417 (10.59)
24	1.498 (38.05)	1.196 (30.98)	.094 (2.39)	1.418 (36.02)	.589 (14.96)	1.469 (37.31)	1.375 (34.92)	1.703 (43.26)	.147 (3.73)	.445 (11.30)

†Not available in KPSE *(TP) located within .010T.P. with respect to diameter A and master keyway.

Thru-Bulkhead Receptacles

MS3119
(MS service class E)

KPTB

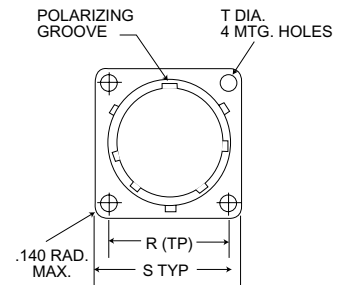
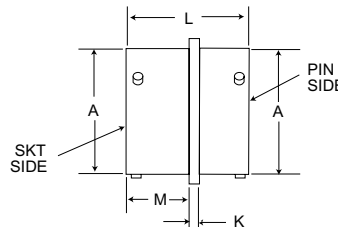

*(T.P) located within .010 T.P. with respect to diameter A and master keyway.

Shell Size	A Dia. ± .003 (±.08)	K ± .016 (±.406)	L Max.	M + .031 (+.79) - .000 (-.00)	R* (TP)	S Max.	T ± .005 (± .127)
†8	.471 (11.96)	.062 (1.57)	1.125 (28.58)	.562 (14.27)	.594 (15.09)	.828 (21.03)	.120 (3.05)
10	.588 (14.94)	.062 (1.57)	1.125 (28.58)	.562 (14.27)	.719 (18.26)	.954 (24.23)	.120 (3.05)
12	.748 (18.00)	.062 (1.57)	1.125 (28.58)	.562 (14.27)	.812 (20.62)	1.047 (26.59)	.120 (3.05)
14	.873 (22.17)	.062 (1.57)	1.125 (28.58)	.562 (14.27)	.906 (23.01)	1.141 (28.98)	.120 (3.05)
16	.998 (25.35)	.062 (1.57)	1.125 (28.58)	.562 (14.27)	.969 (24.61)	1.234 (31.34)	.120 (3.05)
18	1.123 (28.52)	.062 (1.57)	1.125 (28.58)	.562 (14.27)	1.062 (26.97)	1.328 (33.73)	.120 (3.05)
20	1.248 (31.70)	.094 (2.39)	1.406 (35.71)	.688 (17.48)	1.156 (29.36)	1.453 (36.91)	.120 (3.05)
22	1.373 (34.87)	.094 (2.39)	1.406 (35.71)	.688 (17.48)	1.250 (31.76)	1.578 (40.08)	.120 (3.05)
24	1.498 (38.05)	.094 (2.39)	1.406 (35.71)	.688 (17.48)	1.375 (34.92)	1.703 (43.26)	.147 (3.73)

Performance Specifications - Page 142
Contacts, Sealing Plugs, Assembly Tools - Page 154
Contact Arrangements - Page 149

Straight Plugs

MS3116
(MS service class E, F, J, P)
MS3126
(MS service class E, F, P)

KPT06
KPSE06

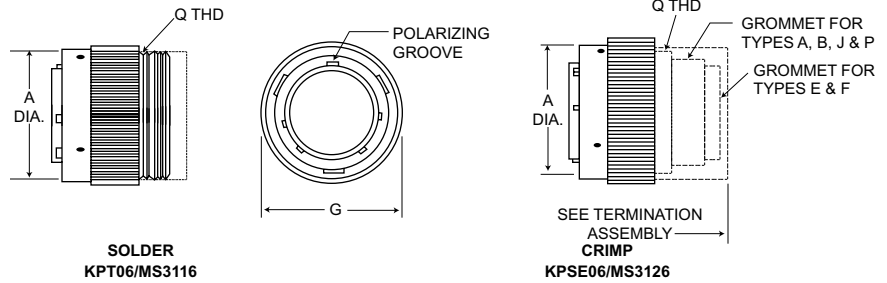

Shell Size	A dia. Max.	G Max.	J ± .010 (±0.25)	Q Thread Class 2A
†8	.765 (19.43)	.782 (19.86)	.353 (8.99)	7/16-28UNEF
10	.840 (21.34)	.926 (23.52)	.353 (8.99)	9/16-24UNEF
12	.999 (25.38)	1.043 (26.49)	.353 (8.99)	11/16-24UNEF
14	1.139 (28.93)	1.183 (30.05)	.353 (8.99)	13/16-20UNEF
16	1.261 (32.03)	1.305 (33.15)	.353 (8.99)	15/16-20UNEF
18	1.337 (33.96)	1.391 (35.33)	.353 (8.99)	1-1/16-18UNEF
20	1.477 (37.52)	1.531 (38.89)	.415 (10.54)	1-3/16-18UNEF
22	1.602 (40.69)	1.656 (42.06)	.415 (10.54)	1-5/16-18UNEF
24	1.723 (43.76)	1.77 (45.14)	.415 (10.54)	1-7/16-18UNEF

†Not available in KPSE

Straight Plugs With Termination Assemblies

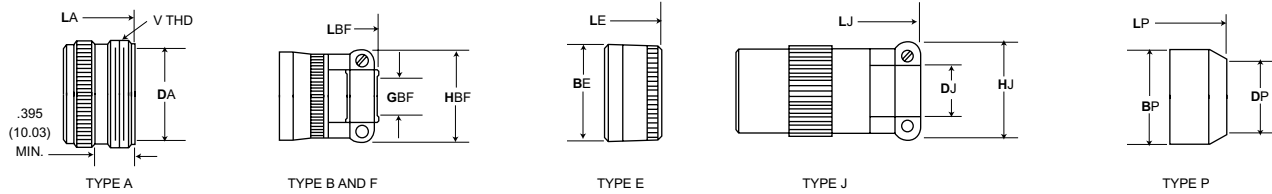

Shell Size	TYPE A			TYPE B and F			TYPE E	
	LA Max.	DA Min.	V Thread Class 2A	LBF Max.	HBF Max.	GBF Min.	BE Max.	LE Max.
†8	1.440 (36.58)	.335 (8.51)	1/2-28UNEF	1.906 (48.41)	.828 (21.03)	.115 (2.02)	.608 (15.44)	1.328 (33.73)
10	1.440 (36.58)	.466 (11.84)	5/8-24UNEF	1.906 (48.41)	.891 (22.63)	.178 (4.52)	.734 (18.64)	1.328 (33.73)
12	1.440 (36.58)	.591 (15.01)	3/4-20UNEF	1.906 (48.41)	1.016 (25.81)	.302 (7.67)	.858 (21.79)	1.328 (33.73)
14	1.440 (36.58)	.705 (19.05)	7/8-20UNEF	1.906 (48.41)	1.141 (28.98)	.365 (9.27)	.984 (24.99)	1.328 (33.73)
16	1.440 (36.58)	.830 (21.08)	1-20UNEF	2.047 (51.99)	1.203 (30.56)	.490 (12.45)	1.110 (28.19)	1.328 (33.73)
18	1.662 (42.21)	.948 (24.08)	1-3/16-18UNEF	2.078 (52.78)	1.469 (37.31)	.615 (15.62)	1.234 (31.34)	1.328 (33.73)
20	1.662 (42.21)	1.043 (26.49)	1-3/16-18UNEF	2.250 (57.15)	1.469 (37.31)	.615 (15.62)	1.360 (34.54)	1.453 (36.91)
22	1.662 (42.21)	1.198 (30.43)	1-7/16-18UNEF	2.250 (57.15)	1.656 (42.06)	.740 (18.80)	1.484 (37.69)	1.453 (36.91)
24	1.672 (42.47)	1.293 (32.84)	1-7/16-18UNEF	2.312 (58.72)	1.750 (44.45)	.790 (20.07)	1.610 (40.89)	1.510 (38.54)

Shell Size	TYPE J			TYPE P		
	LJ Max.	HJ Max.	DJ Max./Min.	LP Max.	DP Min.	BP Max.
†8	2.271 (57.68)	.828 (21.03)	.230/.168 (5.84/4.27)	1.500 (38.10)	.317 (8.05)	.608 (15.44)
10	2.271 (57.68)	.891 (22.63)	.312/.205 (7.92/5.21)	1.500 (38.10)	.434 (11.02)	.734 (18.64)
12	2.411 (61.24)	1.016 (25.81)	.442/.338 (11.23/8.59)	1.500 (38.10)	.548 (13.92)	.858 (21.79)
14	2.599 (66.01)	1.141 (28.98)	.539/.416 (13.56/10.57)	1.500 (38.10)	.673 (17.09)	.984 (24.99)
16	2.943 (74.75)	1.203 (30.56)	.616/.550 (15.65/13.97)	1.500 (38.10)	.798 (20.27)	1.110 (28.19)
18	3.172 (80.57)	1.469 (37.31)	.672/.600 (17.07/15.24)	1.500 (38.10)	.899 (22.83)	1.234 (31.34)
20	3.610 (91.69)	1.469 (37.31)	.747/.634 (18.97/16.13)	1.609 (40.87)	1.024 (26.01)	1.360 (34.54)
22	3.766 (95.66)	1.656 (42.06)	.846/.670 (21.49/17.02)	1.609 (40.87)	1.149 (29.18)	1.484 (37.69)
24	3.985 (101.22)	1.750 (44.45)	.894/.740 (22.71/18.80)	1.687 (42.85)	1.274 (32.36)	1.610 (40.89)

†Not available in KPSE

Performance Specifications - Page 142
Contacts, Sealing Plugs, Assembly Tools - Page 154
Contact Arrangements - Page 149

Jam Nut Receptacles

MS3114
(MS service class E, F, P)
MS3124
(MS service class E, F, P)

KPT07

KPSE07

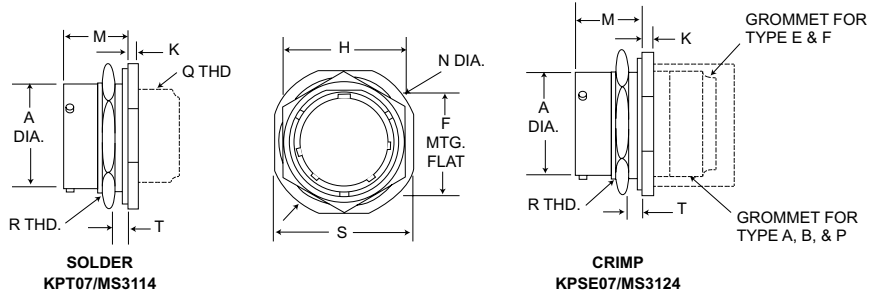

Shell Size	A		H	K	M		N Max.	S Max.	T		R thread Class 2A
	±.003 (±0.08)	±.005 (0.130)			±.017 (±0.43)	±.020 (±.05)			+0.01 (+.08) -.000 (-.00)	Panel Thickness Min.	
†8	.471 (11.96)	.525 (13.34)	.750 (19.05)	.117 (2.97)	.691 (17.55)	1.078 (27.38)	.954 (24.23)	.062 (1.57)	.125 (3.17)	9/16-24UNEF	
10	.588 (14.93)	.650 (16.51)	.875 (22.22)	.117 (2.97)	.691 (17.55)	1.206 (30.56)	1.078 (27.38)	.062 (1.57)	.125 (3.17)	11/16-24UNEF	
12	.748 (19.00)	.813 (20.65)	1.062 (26.97)	.117 (2.97)	.691 (17.55)	1.319 (35.33)	1.266 (32.16)	.062 (1.57)	.125 (3.17)	7/8-20UNEF	
14	.873 (22.17)	.937 (23.80)	1.188 (30.17)	.117 (2.97)	.691 (17.55)	1.516 (38.51)	1.391 (35.33)	.062 (1.57)	.125 (3.17)	1-20UNEF	
16	.988 (25.35)	1.061 (26.95)	1.312 (33.32)	.117 (2.97)	.691 (17.55)	1.641 (41.68)	1.516 (38.51)	.062 (1.57)	.125 (3.17)	1-1/8-18UNEF	
18	1.123 (28.52)	1.186 (30.12)	1.438 (36.25)	.117 (2.97)	.691 (17.55)	1.766 (44.86)	1.41 (41.68)	.062 (1.57)	.125 (3.17)	1-1/4-18UNEF	
20	1.248 (31.70)	1.311 (33.30)	1.562 (39.67)	.148 (3.76)	.879 (22.33)	1.954 (49.63)	1.828 (46.43)	.062 (1.57)	.250 (6.35)	1-3/8-18UNEF	
22	1.373 (34.87)	1.436 (36.47)	1.688 (42.87)	.148 (3.76)	.879 (22.33)	2.078 (52.78)	1.954 (49.63)	.062 (1.57)	.250 (6.35)	1-1/2-18UNEF	
24	1.498 (38.05)	1.561 (39.65)	1.812 (46.02)	.148 (3.76)	.912 (23.16)	2.203 (55.96)	2.078 (52.78)	.062 (1.57)	.250 (6.35)	1-5/8-18UNEF	

†Not available in KPSE

Jam Nut Receptacles With Termination Assemblies

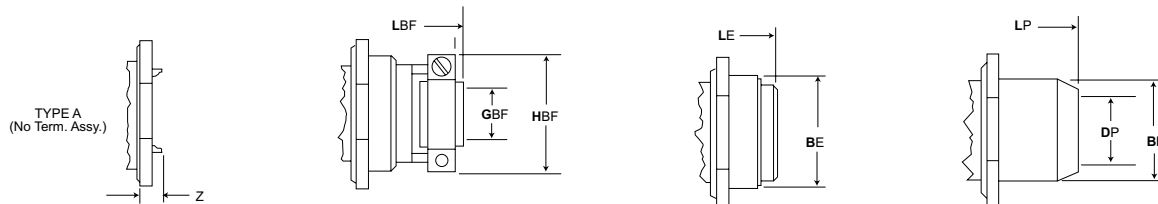

Shell Size	TYPE A	TYPE B AND F			TYPE E		TYPE P		
	Z Max.	HBF Max.	GBF Min.	LBF Max.	BE Max.	LE Max.	BP Max.	DP Min.	LP Max.
†8	.312 (7.92)	.828 (21.03)	.115 (2.02)	1.906 (48.41)	.608 (15.44)	1.344 (34.14)	.608 (15.44)	.317 (8.05)	1.391 (35.33)
10	.312 (7.92)	.891 (22.63)	.178 (4.52)	1.906 (48.41)	.734 (18.64)	1.344 (34.14)	.734 (18.64)	.434 (11.02)	1.391 (35.33)
12	.312 (7.92)	1.016 (25.81)	.302 (7.67)	1.906 (48.41)	.858 (21.79)	1.344 (34.14)	.858 (21.79)	.548 (13.92)	1.391 (35.33)
14	.312 (7.92)	1.141 (28.98)	.365 (9.27)	1.906 (48.41)	.984 (24.99)	1.344 (34.14)	.984 (24.99)	.673 (17.09)	1.391 (35.33)
16	.312 (7.92)	1.203 (30.56)	.490 (12.45)	2.047 (51.99)	1.110 (28.19)	1.344 (34.14)	1.110 (28.19)	.798 (20.27)	1.391 (35.33)
18	.312 (7.92)	1.469 (37.31)	.615 (15.62)	2.078 (52.78)	1.234 (31.34)	1.344 (34.14)	1.234 (31.34)	.899 (22.83)	1.391 (35.33)
20	1.93 (4.90)	1.469 (37.31)	.615 (15.62)	2.328 (59.13)	1.360 (34.54)	1.594 (40.49)	1.360 (34.54)	1.024 (26.01)	1.641 (41.68)
22	1.93 (4.90)	1.656 (42.06)	.740 (18.80)	2.328 (59.13)	1.484 (37.69)	1.594 (40.49)	1.484 (37.69)	1.149 (29.18)	1.641 (41.68)
24	.150 (3.81)	1.750 (44.45)	.790 (20.07)	2.453 (62.31)	1.610 (40.89)	1.641 (41.68)	1.610 (40.89)	1.274 (32.36)	1.703 (43.26)

Performacne Specifications - Page 142

Contacts, Sealing Plugs, Assembly Tools - Page 154

Contact Arrangements - Page 149

Right Angle Plugs

KPT08/KPSE08

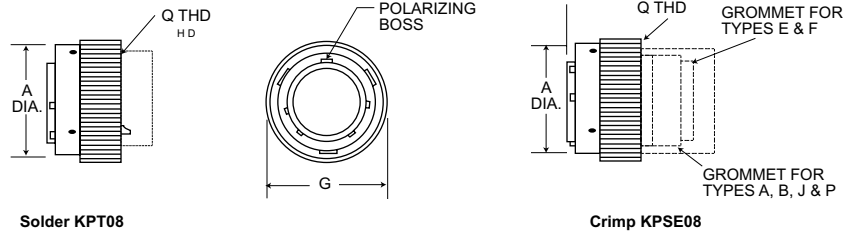

Shell Size	KPT/KPSE		Q Thread Class 2A
	A Dia. Max.	G Max.	
†8	.765 (19.43)	.782 (19.86)	7/16-28UNEF
10	.840 (21.34)	.926 (23.52)	9/16-24UNEF
12	.999 (25.38)	1.043 (26.49)	11/16-24UNEF
14	1.139 (28.93)	1.183 (30.05)	13/16-20UNEF
16	1.261 (32.03)	1.305 (33.15)	15/16-20UNEF
18	1.337 (33.96)	1.391 (35.33)	1-1/16-18UNEF
20	1.477 (37.52)	1.531 (38.89)	1-3/16-18UNEF
22	1.602 (40.69)	1.656 (42.09)	1-5/16-18UNEF
24	1.723 (43.76)	1.777 (45.13)	1-7/16-18UNEF

†Not available in KPSE.
 NOTE: for size 10 and 24 consult factory for availability in type A, B, E and F,
 For size 8 consult factory for availability in Type P.

Right Angle Plugs With Termination Assemblies

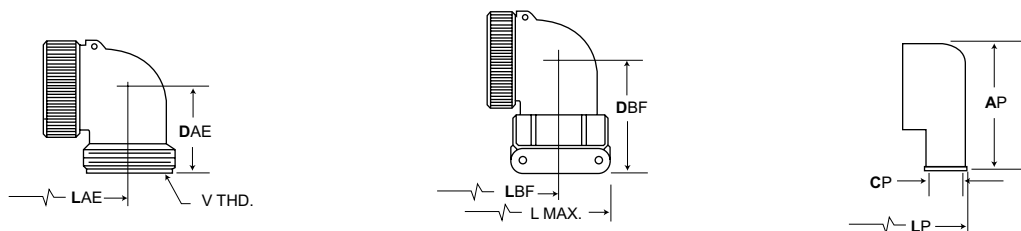

Shell Size	TYPE A AND E			TYPE B AND F				TYPE P			
	LAE Max.	DAE Max.	V Thread Class 2A	DBF Max.	LBF Max.	L Max.	V Thread Class 2A	AP Max.	LP Max.	CP Min.	V Thread Class 2A
†8	1.421 (36.09)	.822 (20.88)	1/2-28UNEF	1.238 (31.44)	1.421 (36.09)	1.842 (46.79)	1/2-28UNEF	-(-)	-(-)	-(-)	1/2-28UNEF
10	1.484 (37.69)	.853 (21.67)	5/8-28UNEF	1.269 (32.24)	1.484 (37.69)	1.937 (49.20)	5/8-28UNEF	1.030 (26.16)	1.380 (35.05)	.252 (6.40)	5/8-28UNEF
12	1.546 (39.27)	.916 (23.27)	3/4-20UNEF	1.395 (35.43)	1.546 (39.27)	1.937 (49.20)	3/4-20UNEF	1.030 (26.16)	1.567 (39.80)	.252 (6.40)	3/4-20UNEF
14	1.577 (40.05)	.978 (24.84)	7/8-20UNEF	1.519 (38.58)	1.577 (40.05)	2.124 (53.95)	7/8-20UNEF	1.030 (26.16)	1.567 (39.80)	.283 (7.19)	7/8-20UNEF
16	1.609 (40.87)	1.041 (26.44)	1-20UNEF	1.582 (40.18)	1.609 (40.87)	2.203 (55.96)	1-20UNEF	1.280 (32.51)	1.567 (39.80)	.355 (9.02)	1-20UNEF
18	1.734 (44.04)	1.103 (28.70)	1-3/16-18UNEF	1.644 (41.76)	1.734 (44.04)	2.380 (60.45)	1-3/16-18UNEF	1.280 (32.51)	1.755 (44.58)	.530 (13.46)	1-3/16-18UNEF
20	1.879 (47.73)	1.166 (29.62)	1-5/16-18UNEF	1.707 (43.36)	1.879 (47.73)	2.629 (66.78)	1-5/16-18UNEF	1.530 (38.86)	1.782 (45.26)	.562 (14.27)	1-5/16-18UNEF
22	2.035 (51.69)	1.245 (31.62)	1-7/16-18UNEF	1.884 (47.85)	2.035 (51.69)	2.629 (66.78)	1-7/16-18UNEF	1.530 (38.86)	1.782 (45.26)	.562 (14.27)	1-7/16-18UNEF
24	2.035 (51.69)	1.322 (33.58)	1-7/16-18UNEF	1.963 (49.86)	2.035 (51.69)	2.895 (73.53)	1-7/16-18UNEF	1.780 (45.21)	2.087 (53.01)	.610 (15.49)	1-7/16-18UNEF

†Not available in KPSE. NOTE: For size 10 and 24 consult factory for availability in type A, B, E and F, For size 8 consult factory for availability in Type P.

Performance Specifications - Page 142
 Contacts, Sealing Plugs, Assembly Tools - Page 154
 Contact Arrangements - Page 149

Contact Arrangements

LEGEND

- ▲ KPT
- ◆ KPSE
- △ Authorized per MIL-C-26482 (NAVY)
- Not MS approved ITTC proprietary

Drawing not to scale; face view of pin insert shown (socket view is opposite)

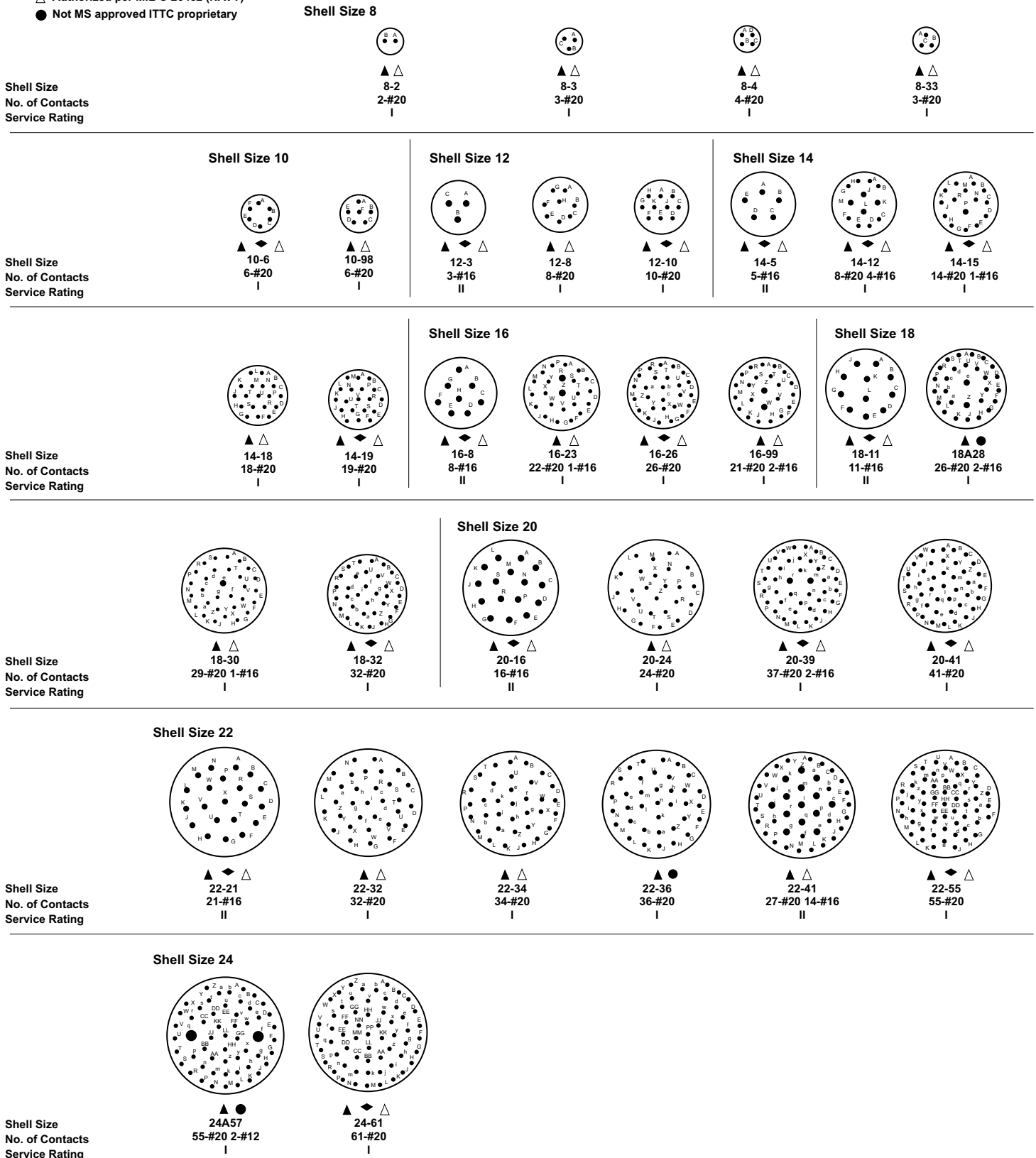

(See page 150 for Alternate Insert Positions.)

Alternate Insert Positions

Face view of pin inserts

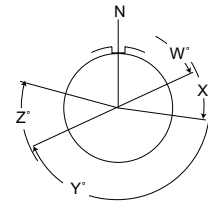

The five positions (W, X, Y, Z and Normal) differ in degree of rotation for various sizes and arrangements.

NO. OF CONTACTS	SHELL SIZE	ARR. NO.	W	Degrees of Rotation			
				X	Y	Z	
2	8	8-2	58	122	-	-	
	8	8-3	60	210	-	-	
3	8	8-33	90	-	-	-	
	12	12-3	-	-	180	-	
4	8	8-4	45	-	-	-	
5	14	14-5	40	92	184	273	
6	10	10-6	90	-	-	-	
	10	10-98	90	180	240	270	
8	12	12-8	90	112	203	292	
	16	16-8	54	152	180	331	
10	12	12-10	60	155	270	295	
11	18	18-11	62	119	241	340	
12	14	14-12	43	90	-	-	
15	14	14-15	17	110	155	234	
16	20	20-16	238	318	333	347	
18	14	14-18	15	90	180	270	
19	14	14-19	30	165	315	-	
21	22	22-21	16	135	175	349	
23	16	16-23	158	270	-	-	
	16	16-99	66	156	223	340	
24	20	20-24	70	145	215	290	
26	16	16-26	60	-	275	338	
28	18	18A28	-	-	-	-	
30	18	18-30	180	193	285	350	
32	18	18-32	85	138	222	265	
	22	22-32	72	145	215	288	
34	22	22-34	62	142	218	298	
36	22	22-36	72	144	216	288	
39	20	20-39	63	144	252	333	
41	20	20-41	45	126	225	-	
	22	22-41	39	135	264	-	
55	22	22-55	30	142	226	314	
57	24	24A57	90	180	270	324	
61	24	24-61	90	180	270	324	

Numbers in bold face indicate contact arrangements are not to MIL-C-26482.

Panel Cutouts

Box and Wall Mounting Receptacle

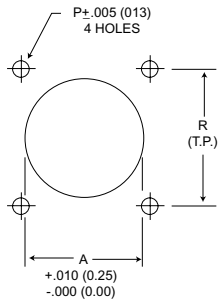

Shell Size	FLANGE (FRONT MOUNTING) KPT/KPSE		MOUNTING HOLE DIA. KPT/KPSE	
	A Dia.	R	P ± .005	Screw
†8	.618 (15.70)	.594 (15.09)	.125 (3.17)	#4
10	.735 (18.67)	.719 (18.26)	.125 (3.17)	#4
12	.859 (21.82)	.812 (20.62)	.125 (3.17)	#4
14	.985 (25.02)	.906 (23.01)	.125 (3.17)	#4
16	1.113 (28.27)	.969 (24.61)	.125 (3.17)	#4
18	1.235 (31.37)	1.062 (26.97)	.125 (3.17)	#4
20	1.361 (34.57)	1.156 (29.36)	.125 (3.17)	#4
22	1.485 (37.72)	1.250 (31.75)	.125 (3.17)	#4
24	1.611 (40.92)	1.375 (34.92)	.155 (3.94)	#6

†Not Available in KPSE connectors.

Jam Nut Receptacle

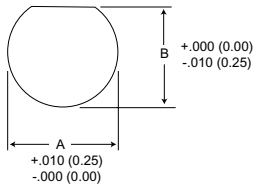

Shell Size	KPT/KPSE	
	A	B
†8	.578 (14.68)	.540 (13.72)
10	.703 (17.86)	.665 (16.89)
12	.890 (22.61)	.828 (21.02)
14	1.015 (25.78)	.952 (24.18)
16	1.140 (28.96)	1.076 (27.33)
18	1.265 (32.13)	1.201 (30.51)
20	1.390 (35.31)	1.326 (33.68)
22	1.515 (38.48)	1.451 (36.86)
24	1.640 (41.66)	1.576 (40.03)

†Not Available in KPSE connectors.

Panel Thickness

Maximum panel thickness dimensions allowable to ensure complete connector operation for the Wall Mounting Receptacle, Box Mounting Receptacle, and Thru-Bulkhead Receptacle.

Wall Mounting and Box Mounting Receptacle

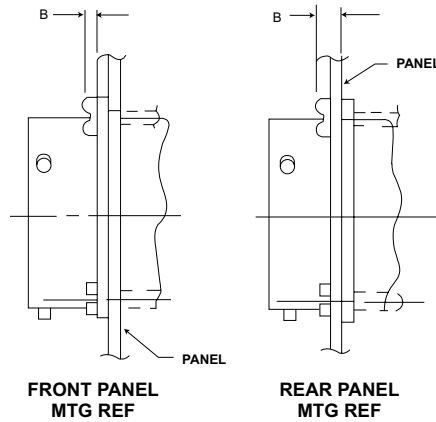

Size	B Max
8	.087 (2.21)
10	
12	
14	
16	
18	.212 (5.38)
20	
22	
24	

Thru-Bulkhead Receptacle

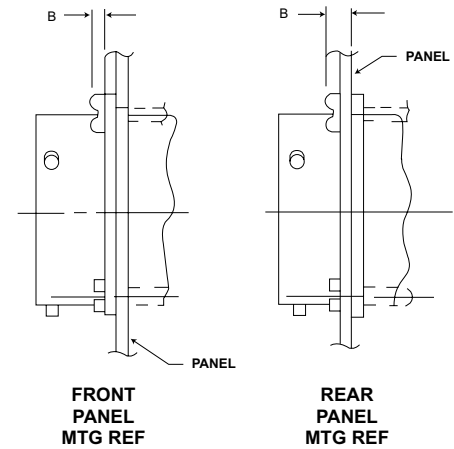

Size	B Max panel and screw head
8	.218 (5.54)
10	
12	
14	
16	
18	.334 (8.74)
20	
22	
24	

Dummy Receptacles

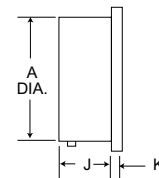
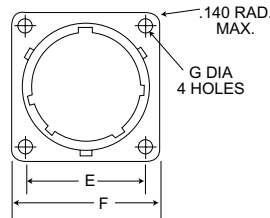
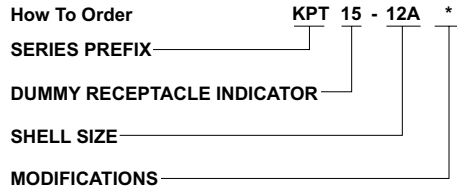

SERIES PREFIX
KPT - ITT Cannon Prefix

NOTE: For MS Version and additional finishes see PV catalog.

SHELL SIZE
8 thru 24

MODIFICATIONS
None - Olive drab chromate over cadmium

Shell Size	A ± .003 (.08)	E Basic	F Max.	G ± .005 (.13)	J +.031 (.79) -.000 (.00)	K ± .016 (.41)
8	.471 (11.96)	.594 (15.09)	.828 (21.03)	.120 (3.05)	.412 (10.46)	.062 (1.57)
10	.588 (14.94)	.719 (18.26)	.954 (24.23)	.120 (3.05)	.412 (10.46)	.062 (1.57)
12	.748 (19.00)	.812 (20.62)	1.047 (26.60)	.120 (3.05)	.412 (10.46)	.062 (1.57)
14	.873 (22.17)	.906 (23.01)	1.141 (28.98)	.120 (3.05)	.412 (10.46)	.062 (1.57)
16	.998 (25.35)	.969 (24.61)	1.234 (31.34)	.120 (3.05)	.412 (10.46)	.062 (1.57)
18	1.123 (28.52)	1.157 (26.97)	1.328 (33.73)	.120 (3.05)	.462 (11.73)	.062 (1.57)
20	1.248 (31.70)	1.156 (23.96)	1.453 (36.91)	.120 (3.05)	.556 (14.12)	.094 (2.39)
22	1.373 (34.87)	1.250 (31.75)	1.578 (40.08)	.120 (3.05)	.556 (14.12)	.094 (2.39)
24	1.498 (38.05)	1.375 (34.93)	1.703 (43.26)	.147 (3.73)	.589 (14.96)	.094 (2.39)

Protective Caps

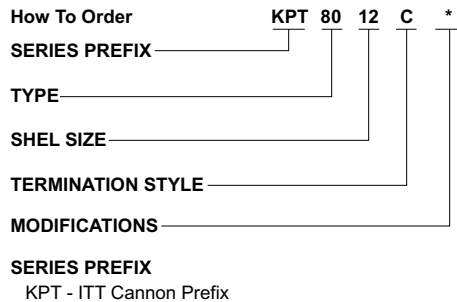

80 - cap for plugs

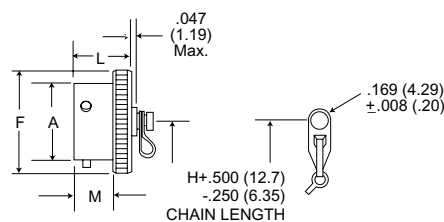

81 - cap for receptacle

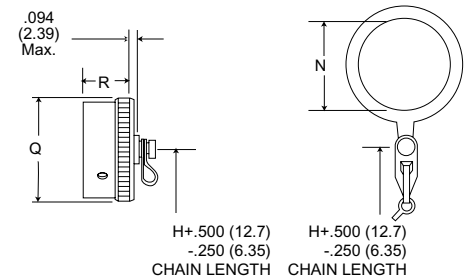

TYPE
80 - Plug Cap
81 - Receptacle Cap

SHELL SIZE
8 thru 24

TERMINATION STYLE
C - Sash Chain
N - Sash Chain with Ring (81 type only)

NOTE: For MS version and additional finishes see PV catalog.
(N Style use Primarily for Jam Nut Receptacle)

Shell Size	A ± .003 (.08)	F Max.	H	L Max.	M +.031 (.79) -.000 (.00)	N Min.	Q Max.	R Max.
8	.471 (11.96)	.719 (18.26)	3.000 (76.20)	.562 (14.27)	.368 (9.35)	.578 (14.68)	.734 (18.64)	.562 (14.27)
10	.588 (14.94)	.844 (21.44)	3.000 (76.20)	.562 (14.27)	.368 (9.35)	.703 (17.86)	.859 (21.82)	.562 (14.27)
12	.748 (19.00)	1.000 (25.40)	3.500 (88.90)	.562 (14.27)	.368 (9.35)	.891 (22.63)	1.000 (24.40)	.562 (14.27)
14	.873 (22.17)	1.125 (28.58)	3.500 (88.90)	.562 (14.27)	.368 (9.35)	1.016 (25.81)	1.125 (28.58)	.562 (14.27)
16	.998 (25.35)	1.250 (31.75)	3.500 (88.90)	.562 (14.27)	.368 (9.35)	1.141 (28.98)	1.250 (31.75)	.562 (14.27)
18	1.123 (28.52)	1.375 (34.93)	3.500 (88.90)	.562 (14.27)	.368 (9.35)	1.266 (32.16)	1.375 (34.93)	.562 (14.27)
20	1.248 (31.70)	1.500 (38.10)	4.000 (101.60)	.625 (15.88)	.430 (10.92)	1.391 (35.33)	1.500 (38.10)	.562 (14.27)
22	1.373 (34.87)	1.625 (41.26)	4.000 (101.60)	.625 (15.88)	.430 (10.92)	1.516 (38.51)	1.625 (41.26)	.562 (14.27)
24	1.498 (38.05)	1.750 (44.45)	4.000 (101.60)	.658 (16.71)	.463 (11.76)	1.641 (41.68)	1.750 (44.45)	.602 (15.29)

MATERIALS AND FINISHES

KPT	
Protective Cap	aluminum alloy, olive drab finish per QQ-P-416
Sash Chain	stainless steel
Ring/Rivet	stainless steel
Gasket	polychloroprene

MIL-C-26482 Specifications

The following excerpts are some of the parameter requirements of the MIL-C-26482 specification.

Test Description	Paragraph Reference	Requirements																																								
Contact Retention	4.6.32.1	After preloading to 3 pounds maximum, the force shall be applied at a rate of approximately 1 pound per second and maintained at full load for 5-10 seconds. No damage to contacts or insert shall result nor shall the contacts be dislocated from their normal position in the connector more than 0.012 inch under give load for KPSE and within 1 minute after the load is removed for KPT.																																								
		<table border="1"> <thead> <tr> <th>Contact Size</th> <th>20</th> <th>16</th> <th>12</th> </tr> </thead> <tbody> <tr> <td>Load in Pounds Min.</td> <td>15</td> <td>25</td> <td>25</td> </tr> </tbody> </table>	Contact Size	20	16	12	Load in Pounds Min.	15	25	25																																
Contact Size	20	16	12																																							
Load in Pounds Min.	15	25	25																																							
Contact Insertion/Extraction (KPSE only)	4.6.11	When using the proper insertion and extraction tools the forces required to insert or extract the contact shall not exceed 20 lbs. Connectors shall be less endbell.																																								
Coupling Torque	4.6.3	For qualification testing, mating halves shall be coupled and uncoupled, measuring the torques necessary. The torques required to couple and uncouple mating connectors halves shall fall within the limits specified as follows:																																								
		<table border="1"> <thead> <tr> <th rowspan="2">Shell Size</th> <th colspan="2">Torque lb./in.</th> <th rowspan="2">Shell Size</th> <th colspan="2">Torque lb./in.</th> </tr> <tr> <th>Max.</th> <th>Min.</th> <th>Max.</th> <th>Min.</th> </tr> </thead> <tbody> <tr> <td>8</td> <td>8</td> <td>1</td> <td>18</td> <td>28</td> <td>4</td> </tr> <tr> <td>10</td> <td>12</td> <td>1</td> <td>20</td> <td>32</td> <td>6</td> </tr> <tr> <td>12</td> <td>16</td> <td>2</td> <td>22</td> <td>36</td> <td>7</td> </tr> <tr> <td>14</td> <td>20</td> <td>4</td> <td>24</td> <td>44</td> <td>7</td> </tr> <tr> <td>16</td> <td>24</td> <td>4</td> <td></td> <td></td> <td></td> </tr> </tbody> </table>	Shell Size	Torque lb./in.		Shell Size	Torque lb./in.		Max.	Min.	Max.	Min.	8	8	1	18	28	4	10	12	1	20	32	6	12	16	2	22	36	7	14	20	4	24	44	7	16	24	4			
Shell Size	Torque lb./in.			Shell Size	Torque lb./in.																																					
	Max.	Min.	Max.		Min.																																					
8	8	1	18	28	4																																					
10	12	1	20	32	6																																					
12	16	2	22	36	7																																					
14	20	4	24	44	7																																					
16	24	4																																								
Durability	4.6.17	Connector halves shall be mated and unmated 500 times at a rate of 200 ± 100 cycles per hour. The test may be performed by hand or by mechanical means, but the coupling ring shall be operated as in normal service. Failure to complete this test because of mechanical malfunction shall be cause for rejection.																																								
Insert Retention	4.6.29	Connectors with the endbells and grommets (if possible) removed shall be subjected to a 75 psi load on the insulator in both directions. The load shall be applied at a rate of 10lb/sec. and held for 5 to 10 secs. Insulators shall not be dislogged from their original position.																																								
Insulation Resistance	4.6.7.1	On unmated connectors at $25^{\circ}\text{C} \pm 3^{\circ}\text{C}$ a potential of 500 VDC $\pm 10\%$ shall be applied between all, but not more than 6, pairs of adjacent contacts and between all, but not more than 6, contacts and the shell. Failure to meet a minimum requirement of 5,000 megohms shall be cause for rejection.																																								
Vibration	4.6.21	Wired, mated connectors shall be subjected to the vibration test of MIL-STD-1344, Method 2005, Test Condition II. Receptacles shall be mounted on the vibration fixture by normal means. All contacts shall be wired in a series circuit and 100 max. milliamperes of current shall be allowed to flow through the series circuit during vibration. Suitable means shall be employed to monitor the current flow and to indicate any discontinuity of more than 10 microseconds. The wire bundle shall be clamped to nonvibrating points at least 8 inches from the rear of the connector. Current discontinuity of 10 microsecond or more, disengagement of the mated connectors, evidence of cracking, breaking, or loosening of parts shall be cause for rejection.																																								
Shock	4.6.23	Wired, mated connectors shall be subjected to one shock in each direction in each of three mutually perpendicular axes. The pulse shall be approximate half sine wave of $50g \pm 15\%$ magnitude with a duration of 11 ± 1 milliseconds. Receptacles shall be mounted on a shock fixture by normal means. All contacts shall be wired in a series circuit and 90-110 ma, of current shall flow through the series circuit during shock. Suitable means shall be employed to Monitor the current flow and to indicate any discontinuity of more than 10 microseconds. Current discontinuity of 10 microseconds or more, disengagement of the mated connectors, evidence of cracking, breaking, or loosening of parts shall be cause for rejection.																																								
Thermal Shock	4.6.12	Wired, unmated plug and receptacle shall be subjected to 5 cycles of hot and cold temperatures. Maximum temperature shall be $+125^{\circ}\text{C}$ and the minimum shall be -55°C . Duration at each temperature extreme shall be 1/2 hour minimum. Cracking, breaking or loosening of parts shall be cause for rejection.																																								
Humidity	4.6.25	The connectors shall be subjected to varying humidity, 50% to 95%, conditions for a period of 10 days KPSE or 20 days KPT. The insulation resistance shall not be less than 100 megohms.																																								
Air Leakage (KPT Only)	4.6.15.1	A 30 psi pressure differential shall be applied across the connector for 30 minutes. The leak rate, in either direction, shall be no greater than 1 atmosphere cubic inch per hour ($4.55 \times 10^{-6} \text{m}^3/\text{S}$) at -67°F (-55°C).																																								
Salt Spray (Corrosion)	4.6.19	Unmated and wired connectors shall be subject to a salt fog for 48 hours. These shall be no exposure of base metal, the connector shall be functional and meet the contact resistance requirement.																																								
Fluid Immersion	4.6.27	At least one connector, unmated and wired, shall be immersed in each fluid for a period of 20 hours then dried at room conditions for hour. Connectors shall be able to mate and meet the coupling torque requirements. a) Hydraulic Fluid per MIL-H-5606, b) Lubricating Oil per MIL-L-7808																																								

Tooling, Crimp

M22520/1-01 CRIMP TOOL
M22520/1-02 Turret



CBT-520/530

Tooling, Insertion/Extraction



KPSE Insertion



KPSE Extraction

Contact Size	
20	MS24256A20
16	MS24256A16

Contact Size	
20	MS24256R20
16	MS24256R16

Contacts

Contact Size/Type	Military Part Number	Color Bands			ITT Cannon Part Number
		1st	2nd	3rd	
20 Socket	M39029/32-259	Red	Green	White	031-9074-002
20 Pin	M39029/31-240	Red	Yellow	Black	030-9036-000
16 Socket	M39029/32-247	Red	Yellow	Violet	031-9095-003
16 Pin	M39029/31-228	Red	Red	Grey	030-9032-003

#20

Contacts for printed circuit applications also available

Wire Hole Fillers/Grommets Sealing Plugs

Contact Size	Part Number		Color Code
	Cannon	Military	
20	225-1012-000	MS3187A20	Red
16	225-1011-000	MS3187-16	Blue

KPSE Assembly Instructions

Contact Size	Wire Size AWG	Strip Insulation
20	#20-#24	3/16"
16	#16-#20	1/4"

Right

Wrong



CRIMPING CONTACTS

1. Strip wires according to the table above taking care not to cut or nick strands.

2. Insert stripped wire into contact crimp pot. Wire must be visible thru inspection hole.

3. Using correct crimp tool and locator select proper crimp setting for wire size to be crimped; cycle the tool once to be sure the indentors are open. Insert contact and wire into locator. Squeeze tool handles firmly and completely to insure a proper crimp. The tool will not release unless the crimp indentors in the tool head have been fully actuated. Release crimped contact and wire from tool. Be certain the wire is visible thru inspection hole in contact.

CAUTION: Check that none of the contacts are bent or damaged in any way after crimping.

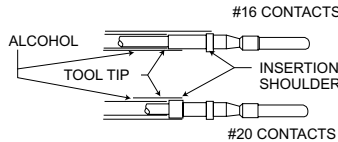
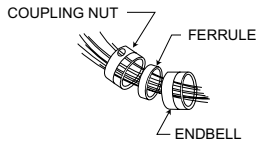

CONTACT INSERTION

1. Remove hardware from plug and receptacle. Slide hardware over wire bundle in proper order for reassembly.

2. Use the proper contact insertion tool and slide the tool over the terminal end of the contact. The size 16 contact lies in the tool and the tool tip butts against the contact shoulder. The rear, or insulation support of the size 20 contact butts against an internal shoulder in the tool tip.

NOTE: Apply a small amount of isopropyl alcohol to the insertion tool tip while installing contacts.

3. Beginning from center cavity and working outwards in a circular pattern, insert wired contacts into rear of connector by hand until the front of the contact shoulder is no more than 1/8" from the grommet. Holding the connector horizontally, position tool behind contact. Push tool straight into contact cavity until contact snaps into position. A light pull on wire will assure that contact is locked securely. Repeat for remaining contacts.



Size	Torque in/lbs.
8,10,12 and 14	10-15
16 and 18	15-25
20,22 and 24	25-35

4. Use contacts and grommet sealing plugs to fill any empty cavities.

COMPLETION

1. Check face of plug or receptacle for proper contact installation.

2. Using mating connector with contacts installed, mate both connector halves together.

3. Assemble ferrule over the grommet by hand as far as possible.

4. Assemble endbell over ferrule and loosely tighten endbell. Partially loosen (1/4 turn) and retighten to recommended torque limits.



2nd Index Line
Socket Contacts

1st Index Line
Pin Contacts



CONTACT EXTRACTION

1. Slide hardware back over wire bundle. Using proper extraction tool or extraction end of proper insertion/extraction tool, proceed as follows:

KPSE: There are two lines on the clip sleeve which are vital to the contact removal process. The first index line is used for removing pin contacts while the second index line is for removing socket contacts.

Carefully place the tool tip over the contact to be extracted until the tool tip touches the insulator face. Carefully rotate the tool until the index line is slightly below the insulator face. Keep an even pressure against tool body; push plunger forward with thumb and index finger, and push the contact out through the clip. Carefully remove extraction tool from connector. Pull wire by hand to complete the removal of the contact.

How to Order - Special Termination Connectors



KPT	03	-	18	-	32	P	W
KPT	04	-	18	-	32	P	W
KPT	05	-	18	-	32	P	W
KPSE	03	-	18	-	32	P	W
KPSE	04	-	18	-	32	P	W
KPSE	05	-	18	-	32	P	W

PREFIX _____
 SHELL STYLE _____
 DASH (No Class required, less rear termination) _____
 SHELL SIZE _____
 CONTACT ARRANGEMENT _____
 CONTACT TYPE _____
 P - PIN
 S - Socket
 ALTERNATE INSERT POSITION _____

Contact ITT Cannon for additional information

Solder Type KPT03/04/05-Supplied less endbell, ferrule and grommet.

KPT03

KPT04



KPT05



Solder Type KPSE03/04/05-Supplied less endbell, ferrule.

KPSE03



KPSE04

KPSE05



Twist Pull Lanyard Release Coupler Plug

KPT06/KPSE06



KPT	6	A	22	-	55	P	W	16
KPSE	6	E	22	-	55	S	Z	16

PREFIX _____
 SHELL STYLE _____
 SERVICE TYPE _____
 SHELL SIZE _____
 CONTACT ARRANGEMENT _____
 CONTACT TYPE _____
 POLARIZATION _____
 MODIFICATION CODE* _____

*Omit (0) of shell style indication when using this modification code.

16 = Overall length of connector including lanyard to be 6.0 (152.40) ± .125 (3.18) when measured over a 1.0 (25.40) ± .005 (0.13) diameter mandrel.

Printed Circuit Termination

KPT02E



KPT07



- Interchangeable with MIL-C-26482 Series 1
- Operating temperature - 55°C to + 200°C

The PV connector is designed to meet the rugged requirements of MIL-C-26482, Series 2/MIL-C-83723 Series 1*, the specification which delineates the critical requirements of space-age applications. PV connectors have been used extensively on major aerospace programs requiring general-purpose, miniature cylindrical bayonet coupling connectors such as Space Shuttle, Apollo, ATM, OWS Minuteman, Skylab, Thor-Delta, Titan IIIC, and Viking.

The PV series is an important member of the Universal Interconnect System (UIS) - the only system that can perform all interconnection missions. This system is adaptable for use with connectors of all shapes and sizes, including circular and rectangular configurations, standard, miniature and subminiature sizes. UIS is a rear servicing system that evolved from the LITTLE CAESAR® rear release contact retention assembly, pioneered and developed by ITT Cannon. Since this time, ITT Cannon, and its licensees, have supplied to industry over 250 million interconnections utilizing this system.

PV7 connectors are available under numerous industrial specifications, some of which are listed below:

- CS512089 Jet Propulsion Laboratory
- 40M39569 NASA, George C. Marshall Space Flight Center
- 81D52 Martin Marietta, Denver Division
- MG414-0365 Rockwell International Space Division
- AC414-0013 Rockwell International Autonetics Division
- STS0003 McDonnell Douglas Astronautics

This connector series is manufactured to accommodate the following backshells: M85049/31 (MS3416), M85049/51 (MS3418) and M85049/52 (MS3417). Backshells are not included with connector and must be ordered separately. Backshells on page 161 are Non-MS type.

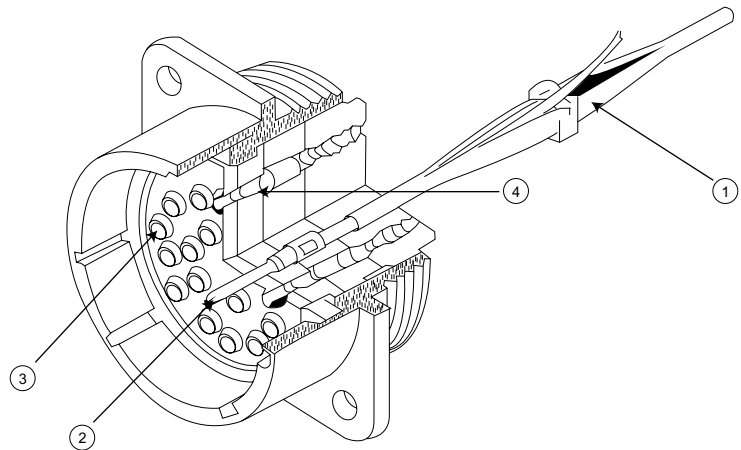

Universal Insertion / Extraction Tool Style - A single, expendable plastic tool is used for insertion and extraction of both pins and sockets.

Simple, Strong Contact Design - One basic configuration eliminates undercuts and maximizes bend resistance for positive contact mating.

Closed-Entry Socket Insert - Hard dielectric socket face of mating connector has lead-in chamfers for positive alignment of pins and sockets.



Interfacial Pin Insert Seal - Universal interconnect permits design of raised moisture barriers around each pin which mate into lead-in chambers of hard face sockets insert for individual contact sealing. Interfacial sealing is never touched by service tools.

Superior Contact Stability - Rear Contact Release System (LITTLE CAESAR contact assembly) features a stamped metal retaining clip captivated by molded-in shoulders of each contact cavity in the insulator. A rear-inserted plastic tool expands the tines beyond the contact shoulder, releasing the contact.

Polarized Backshells - Interlocking teeth on the front of the backshell and rear portion of the shell allow endbells to be positioned as desired, eliminating chafing of wire during assembly.

Military Specification Cross Reference

PV7 and MIL-C-26482 (Series 2) Replacement for	MS Standards	ITT Cannon Prefix	MIL-C-83723*		Description
		Commercial Design	Socket	Pin	
MIL-C-26482 (Series 1)		MIL-C-26482	Socket	Pin	
MS3110,MS3120	MS3470	PV70	/1	/2	Narrow Flange Receptacle
MS3111,MS3121	MS3471	PV71	/7	/8	Cable Connecting Receptacle
MS3112,MS3122	MS3470	PV70	/1	/12	Narrow Flange Receptacle
MS3114,MS3124	MS3474	PV74	/5	/6	Jam Nut Receptacle
MS3116,MS3126	MS3476	PV76	/13	/14	Straight Plug
	MS3472	PV72	/3	/4	Wide Flange Receptacle
	MS3475	PV75	/43	/42	Straight Plug, RFI Shielded
NAS1599					
NAS1650,NAS1699	MS3470		/1	/2	Narrow Flange Receptacle
NAS1651,NAS1700	MS3472		/3	/4	Wide Flange Receptacle
NAS1652,NAS1701	MS3474		/5	/6	Jam Nut Receptacle
NAS1653,NAS1702	MS3476		/13	/14	Straight Plug

*NOTE: M83723 series has been superseded by MIL-C-26482 Series 2.

Performance and Material Specifications

MATERIALS AND FINISHES

Description	Material	Finish
Shell	Aluminum alloy per QQ-A-367, QQ-A-591 or QQ-A-225	Electroless nickel per MIL-C-26074, anodized per MIL-A-8625 or olive drab cadmium over nickel
Insulators	Rigid dielectric	None
Elastomers (grommets, interfacial and O ring seals)	Silicone rubber (ITT Cannon blend) or Fluorosilicone rubber (ITT Cannon blen)	None None
Contacts	Copper alloy	Gold page per MIL-G-45204
Coupling Nut	Aluminum alloy per QQ-A-591	Electroless nickel per MIL-C-26074, anodized per MIL-A-8625 or olive drab cadmium over nickel
Jam Nut (on PV74)	Aluminum alloy per QQ-A-225	Electroless nickel per MIL-C-26074, anodized per MIL-A-8625 or olive drab cadmium over nickel

ELECTRICAL

Contact Size	Wire Size	Insulation O.D. Limits, inch (mm)		Max Current for Test (amps)	Potential Drop (Millivolts at 25°C)
		min.	max.		
12	12	.097 (2.46)	.158 (4.01)	23	50
	14				
16	16	.053 (1.53)	.103 (2.62)	13	50
	20				
20	20	.040 (1.02)	.083 (2.11)	7.5	55
	24				

Service Rating	Dielectric Withstanding Voltage (Test Voltage)		
	Sea Level	70,000 ft. Altitude	(25°C)
I	1500 Vac rms	375 Vac rms	5000 megohms minimum
II	2300 Vac rms	500 Vac rms	5000 megohms minimum

How to Order

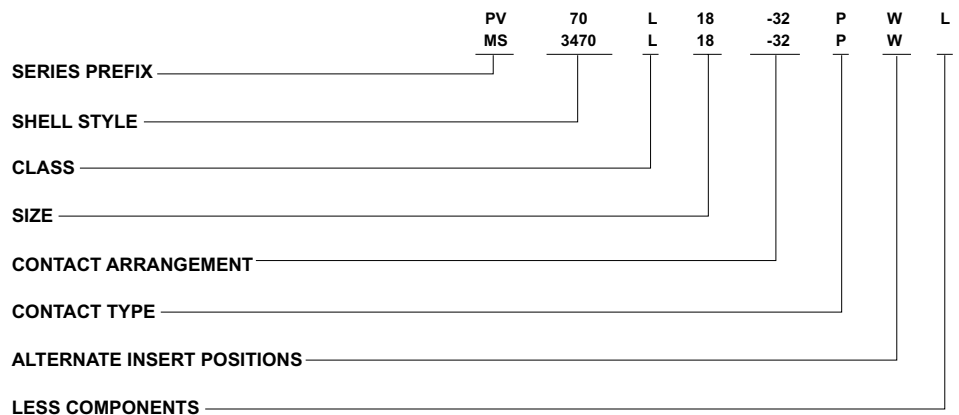

SERIES PREFIX

MS - Complies with MIL-C-26482 Series 2
 PV - ITT Cannon Interchangeable with MIL-C-26482, Series 2

SHELL STYLE

ITT Cannon Part No.	Military No.	Description
PV70	MS3470	- Narrow Flange Receptacle
PV71	MS3471	- Cable Connecting Receptacle
PV72	MS3472	- Wide Flange Receptacle
PV74	MS3474	- Jam Nut Receptacle
PV75	MS3475	- Straight Plug, RFI Shielded
PV76	MS3476	- Straight Plug

CLASS

(PV Series and MS Series)
 *A - Fluid resistant, 200°C, non-conductive (anodized)
 L - Fluid resistant, 200°C, conductive, finish (nickely)
 W - Corrosive and fluid resistant, 175°C (cadmium over nickel)

SHELL SIZE

8, 10, 12, 14, 16, 18, 20, 22 and 24
 (Size 8 available in PV70 & 76 only)

CONTACT ARRANGEMENTS

See page 162.

CONTACT TYPE

P - Pin contact
 S - Socket contact
 A - Less pin contact* (MS only)
 B - Less socket contacts* (MS only)
 * The "A" and "B" designators are used only when other than power contacts are to be installed (i.e. shielded, coaxial and thermocouple contacts).

ALTERNATE INSERT POSITIONS

No designation required for normal position.
 Standard MS alternate positions available.

LESS COMPONENTS

Use "L" if PV connectors are ordered less contacts, sealing plugs and insertion/extraction tool ("L" is not stamped on connectors). To order MS connectors *less contacts*, purchase order must state less contacts.

*Consult factory for availability.



Cannon

Dimensions are shown in inches (millimeters).
 Dimensions subject to change.

www.ittcannon.com

Narrow Flange Receptacle

MS3470

PV70

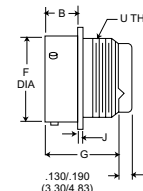
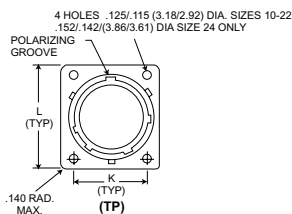

Shell Size*	B Max	F Max	G Max	J Max	K	L	U Thread UNEF Class 2A
8	.462 (11.73)	.474 (12.04)	1.215 (30.85)	.078 (1.98)	.594 (15.09)	.828 (21.03)	1/2-20
10	.462 (11.73)	.594 (15.01)	1.215 (30.85)	.078 (1.98)	.719 (18.26)	.954 (24.23)	5/8-24
12	.462 (11.73)	.751 (19.08)	1.215 (30.85)	.078 (1.98)	.812 (20.62)	1.047 (26.59)	3/4-20
14	.462 (11.73)	.876 (22.25)	1.215 (30.85)	.078 (1.98)	.906 (23.01)	1.141 (28.98)	7/8-20
16	.462 (11.73)	1.001 (25.43)	1.215 (30.85)	.078 (1.98)	.969 (24.61)	1.234 (31.34)	1-20
18	.462 (11.73)	1.126 (28.60)	1.215 (30.85)	.078 (1.98)	1.062 (26.97)	1.328 (33.73)	1-1/16-18
20	.587 (14.91)	1.251 (31.78)	1.275 (32.40)	.110 (2.79)	1.156 (29.36)	1.453 (36.91)	1-3/16-18
22	.587 (14.91)	1.376 (34.95)	1.275 (32.40)	.110 (2.79)	1.250 (31.75)	1.578 (40.08)	1-5/16-18
24	.620 (15.75)	1.501 (38.13)	1.275 (32.40)	.110 (2.79)	1.375 (34.93)	1.703 (43.26)	1-7/16-18

Cable Connecting Receptacle

MS3471

PV71

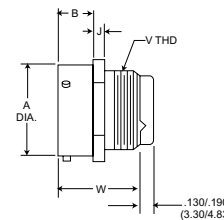
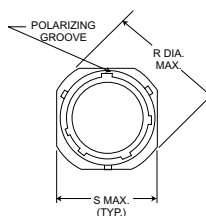

Shell Size*	A Max	B Max	J Max	R Dia. Max	S Max	W Max	U Thread UNEF Class 2A
10	.591 (15.01)	.462 (11.73)	.078 (1.98)	1.082 (27.48)	.954 (24.23)	1.215 (30.86)	5/8-24
12	.751 (19.08)	.462 (11.73)	.078 (1.98)	1.176 (29.87)	1.047 (26.59)	1.215 (30.86)	3/4-20
14	.876 (22.25)	.462 (11.73)	.078 (1.98)	1.270 (32.26)	1.141 (28.98)	1.215 (30.86)	7/8-20
16	1.001 (25.43)	.462 (11.73)	.078 (1.98)	1.364 (34.64)	1.234 (31.34)	1.215 (30.86)	1-20
18	1.126 (28.60)	.462 (11.73)	.078 (1.98)	1.458 (37.03)	1.328 (33.73)	1.215 (30.86)	1-1/16-18
20	1.251 (31.78)	.587 (14.91)	.110 (2.79)	1.708 (43.38)	1.578 (40.08)	1.275 (32.38)	1-5/16-18
22	1.376 (34.95)	.587 (14.91)	.110 (2.79)	1.708 (43.38)	1.578 (40.08)	1.275 (32.38)	1-5/16-18
24	1.501 (38.13)	.620 (15.75)	.110 (2.79)	1.832 (46.53)	1.703 (43.26)	1.275 (32.38)	1-7/16-18

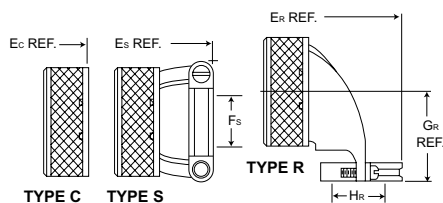

Backshell Assemblies not supplied with MS connectors.

Performance Specifications - Page 158

Contacts, Sealing Plugs, Assembly Tools - Pages

163, 165

Contacts Arrangements - Page 162

Receptacle Assembly With Backshell†

Shell Size*	TYPE C		TYPE S		TYPE R		
	Ec Max.	Fs Max.	Es Max.	Gr Max.	Hr Max.	Er Max.	
10	1.492 (37.90)	.286 (7.26)	1.842 (46.79)	.880 (23.35)	.286 (7.26)	2.115 (53.72)	
12	1.492 (37.90)	.416 (10.57)	1.842 (46.79)	.950 (24.13)	.416 (10.57)	2.250 (57.15)	
14	1.492 (37.90)	.476 (12.09)	2.077 (52.76)	1.010 (25.65)	.476 (12.09)	2.340 (59.44)	
16	1.492 (37.90)	.626 (15.90)	2.077 (52.76)	1.070 (27.18)	.626 (15.90)	2.475 (62.87)	
18	1.492 (37.90)	.706 (17.93)	2.077 (52.76)	1.130 (28.70)	.706 (17.93)	2.574 (65.38)	
20	1.552 (39.42)	.831 (21.11)	2.137 (54.28)	1.190 (30.23)	.831 (21.11)	2.767 (70.28)	
22	1.552 (39.42)	.956 (24.28)	2.137 (54.28)	1.260 (32.00)	.956 (24.28)	2.890 (73.41)	
24	1.552 (39.42)	1.081 (27.46)	2.137 (54.28)	1.320 (33.53)	1.081 (27.46)	3.012 (76.50)	

*See page 158 for part numbers.† To order backshell assemblies separately, see page 161.

Wide Flange Receptacle

MS3472

PV72

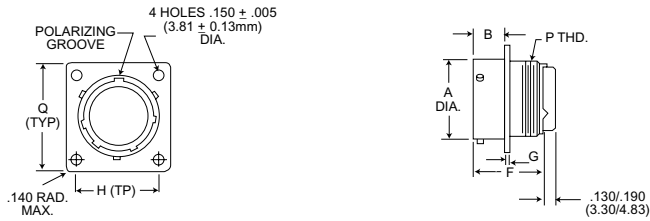

Shell Size*	A Max.	B Max.	F Max.	G Max.	H Max.	Q Max.	P Thread UNEF Class A
10	.591 (15.01)	.493 (12.52)	1.215 (30.85)	.078 (1.98)	.812 (20.62)	1.141 (28.98)	5/8-24
12	.751 (19.08)	.493 (12.52)	1.215 (30.85)	.078 (1.98)	.938 (23.83)	1.266 (32.16)	3/4-20
14	.876 (22.25)	.493 (12.52)	1.215 (30.85)	.078 (1.98)	1.031 (26.19)	1.360 (34.54)	7/8-20
16	1.001 (25.43)	.493 (12.52)	1.215 (30.85)	.078 (1.98)	1.125 (28.58)	1.453 (36.91)	1-20
18	1.126 (28.60)	.493 (12.52)	1.215 (30.85)	.078 (1.98)	1.203 (30.56)	1.532 (38.91)	1-1/16-18
20	1.251 (31.78)	.587 (14.91)	1.275 (32.40)	.110 (1.98)	1.297 (32.94)	1.688 (42.88)	1-3/16-18
22	1.376 (34.95)	.587 (14.91)	1.275 (32.40)	.110 (1.98)	1.375 (34.93)	1.766 (44.86)	1-5/16-18
24	1.501 (38.13)	.620 (15.75)	1.275 (32.40)	.110 (1.98)	1.500 (38.10)	1.891 (48.03)	1-7/16-18

Jam Nut Receptacle

MS3474

PV74

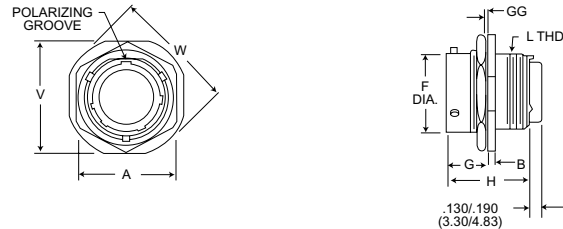

Shell Size*	V Max.	A Max.	B Max.	F Max.	G Max.	GG Panel Thickness	H Max.	W Dia. Max.	L Thread UNEF Class 2
8	.954 (24.23)	.767 (19.48)	.113 (2.87)	.474 (12.04)	.707 (17.96)	.187/.062 (4.75/1.57)	1.215 (30.86)	1.078 (27.38)	1/2-20
10	1.078 (27.38)	.892 (22.66)	.113 (2.87)	.591 (15.01)	.707 (17.96)	.187/.062 (4.75/1.57)	1.215 (30.85)	1.203 (30.56)	5/8-24
12	1.266 (32.16)	1.079 (27.41)	.113 (2.87)	.751 (19.08)	.707 (17.96)	.187/.062 (4.75/1.57)	1.215 (30.85)	1.391 (35.33)	3/4-20
14	1.391 (35.33)	1.205 (30.61)	.113 (2.87)	.876 (22.25)	.707 (17.96)	.187/.062 (4.75/1.57)	1.215 (30.85)	1.516 (38.51)	7/8-20
16	1.516 (38.51)	1.329 (33.76)	.113 (2.87)	1.001 (25.43)	.707 (17.96)	.187/.062 (4.75/1.57)	1.215 (30.85)	1.641 (41.68)	1-20
18	1.641 (41.68)	1.455 (36.96)	.113 (2.87)	1.126 (28.60)	.707 (17.96)	.187/.062 (4.75/1.57)	1.215 (30.85)	1.766 (44.86)	1-1/16-18
20	1.828 (46.43)	1.579 (40.11)	.148 (3.76)	1.251 (31.78)	.772 (19.61)	.250/.062 (6.35/1.57)	1.275 (32.40)	1.954 (49.63)	1-3/16-18
22	1.954 (49.63)	1.705 (40.11)	.148 (3.76)	1.376 (34.95)	.772 (19.61)	.250/.062 (6.35/1.57)	1.275 (32.40)	2.078 (52.78)	1-5/16-18
24	2.078 (52.78)	1.829 (46.46)	.148 (3.76)	1.501 (38.13)	.772 (19.61)	.219/.062 (5.56/1.57)	1.275 (32.40)	2.203 (55.96)	1-7/16-18

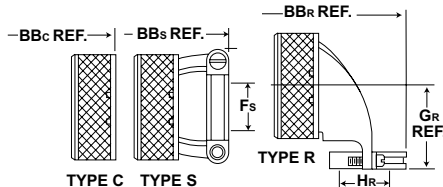

Backshell Assemblies not supplied with MS connectors.

Performance Specifications - Page 158

Contacts, Sealing Plugs, Assembly Tools - Pages 163, 165

Contact Arrangements - Page 162

Receptacle Assembly With Backshell†

Shell Size*	TYPE S			TYPE R		
	TYPE C BBc Max.	BBs Max.	Fs Max.	BBr Max.	Gr Max.	Hr Max.
10	1.492 (37.90)	1.842 (46.79)	.286 (7.26)	2.115 (53.72)	.880 (22.35)	.286 (7.26)
12	1.492 (37.90)	1.842 (46.79)	.416 (10.57)	2.250 (57.15)	.950 (24.13)	.416 (10.57)
14	1.492 (37.90)	2.077 (52.76)	.476 (12.09)	2.340 (59.44)	1.010 (25.65)	.476 (12.09)
16	1.492 (37.90)	2.077 (52.76)	.626 (15.90)	2.475 (62.87)	1.070 (27.18)	.626 (15.90)
18	1.492 (37.90)	2.077 (52.76)	.706 (17.93)	2.574 (65.38)	1.130 (28.70)	.706 (17.93)
20	1.552 (39.42)	2.137 (54.28)	.831 (21.11)	2.767 (70.28)	1.190 (30.23)	.831 (21.11)
22	1.552 (39.42)	2.137 (54.28)	.956 (24.28)	2.890 (73.41)	1.260 (32.00)	.956 (24.28)
24	1.552 (39.42)	2.137 (54.28)	1.081 (27.46)	3.012 (76.50)	1.320 (33.53)	1.081 (27.46)

* See page 158 for part numbers. † To order backshell assemblies separately, see page 161.

Straight Plug

MS3476

PV76

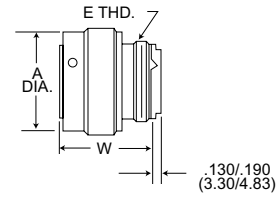
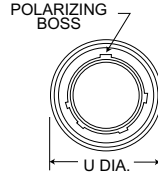

Shell Size*	A Dia. Max.	U Max.	W Max.	E Thread UNEF Class 2A
8	.765 (19.43)	.782 (19.86)	1.230 (31.24)	1/2-20
10	.840 (21.34)	.926 (23.52)	1.230 (31.24)	5/8-24
12	.999 (25.37)	1.043 (26.49)	1.230 (31.24)	3/4-20
14	1.139 (28.93)	1.183 (30.05)	1.230 (31.24)	7/8-20
16	1.261 (32.03)	1.305 (33.15)	1.230 (31.24)	1-20
18	1.337 (33.96)	1.391 (35.33)	1.230 (31.24)	1-1/16-18
20	1.477 (37.52)	1.531 (38.89)	1.230 (31.24)	1-3/16-18
22	1.602 (40.69)	1.656 (42.06)	1.230 (31.24)	1-5/16-18
24	1.723 (43.76)	1.777 (45.14)	1.230 (31.24)	1-7/16-18

MS34745

PV75

Straight Plug, RFI Shielded



Shell Size*	E Thread UNEF Class 2A	A Dia. Max.	U Max.	W Max.
10	5/8-24	.840 (21.34)	.926 (21.72)	1.230 (31.24)
12	3/4-20	.999 (25.37)	1.043 (26.42)	1.230 (31.24)
14	7/8-20	1.139 (28.93)	1.183 (29.97)	1.230 (31.24)
16	1-20	1.261 (32.03)	1.305 (33.15)	1.230 (31.24)
18	1-1/16-18	1.337 (33.96)	1.391 (35.33)	1.230 (31.24)
20	1-3/16-18	1.477 (37.52)	1.531 (38.89)	1.230 (31.24)
22	1-5/16-18	1.602 (40.69)	1.656 (42.06)	1.230 (31.24)
24	1-7/16-18	1.723 (43.76)	1.777 (45.14)	1.230 (31.24)

* See page 158 for part numbers.

Plug Assemblies with Backshell †

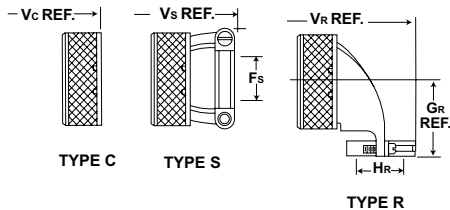

Backshell Assemblies not supplied with MS connectors.

Performance Specifications - Page 158

Contacts, Sealing Plugs, Assembly Tools - Pages 163, 165

Contact Arrangements - Page 162

Shell Size*	TYPE C	TYPE S		TYPE R		
	Vc Max.	Fs Max.	Vs Max.	Gr Max.	Hr Max.	Vr Max.
8						
10	1.507 (38.28)	.286 (7.26)	1.857 (47.17)	.880 (22.35)	.286 (7.26)	2.130 (54.10)
12	1.507 (38.28)	.416 (10.57)	1.857 (47.17)	.950 (24.13)	.416 (10.57)	2.265 (57.53)
14	1.507 (38.28)	.476 (12.09)	2.092 (53.14)	1.010 (25.65)	.476 (12.09)	2.355 (59.82)
16	1.507 (38.28)	.626 (15.90)	2.092 (53.14)	1.070 (27.18)	.626 (15.90)	2.490 (63.25)
18	1.507 (38.28)	.706 (17.93)	2.092 (53.14)	1.130 (28.70)	.706 (17.93)	2.589 (65.76)
20	1.507 (38.28)	.831 (21.11)	2.092 (53.14)	1.190 (30.23)	.831 (21.11)	2.722 (69.14)
22	1.507 (38.28)	.956 (24.28)	2.092 (53.14)	1.260 (32.00)	.956 (24.28)	2.845 (72.26)
24	1.507 (38.28)	1.081 (27.46)	2.092 (52.14)	1.320 (33.53)	1.081 (27.46)	2.967 (75.36)

* See page 158 for part numbers. † To order backshell assemblies separately, see page 161.

Backshells (Non-MS)

(Not supplied with MS Connectors)

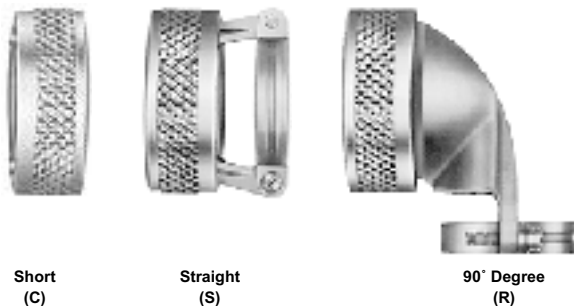

Shell Size*	TYPE C (SHORT)	TYPE S (Straight)	TYPE R (90°)
	ITT CANNON Conductive (Nickel finish)	ITT CANNON Conductive (Nickel finish)	ITT CANNON Conductive (Nickel finish)
10	057-0716-002	057-0683-002	057-0704-001
12	057-0717-002	057-0684-002	057-0705-001
14	057-0718-002	057-0685-002	057-0706-001
16	057-0719-002	057-0686-002	057-0707-001
18	057-0720-002	057-0687-002	057-0708-001
20	057-0721-002	057-0688-002	057-0709-001
22	057-0722-002	057-0689-002	057-0710-001
24	057-0723-002	057-0731-002	057-0711-001

Contact Arrangements

Face view, pin insert

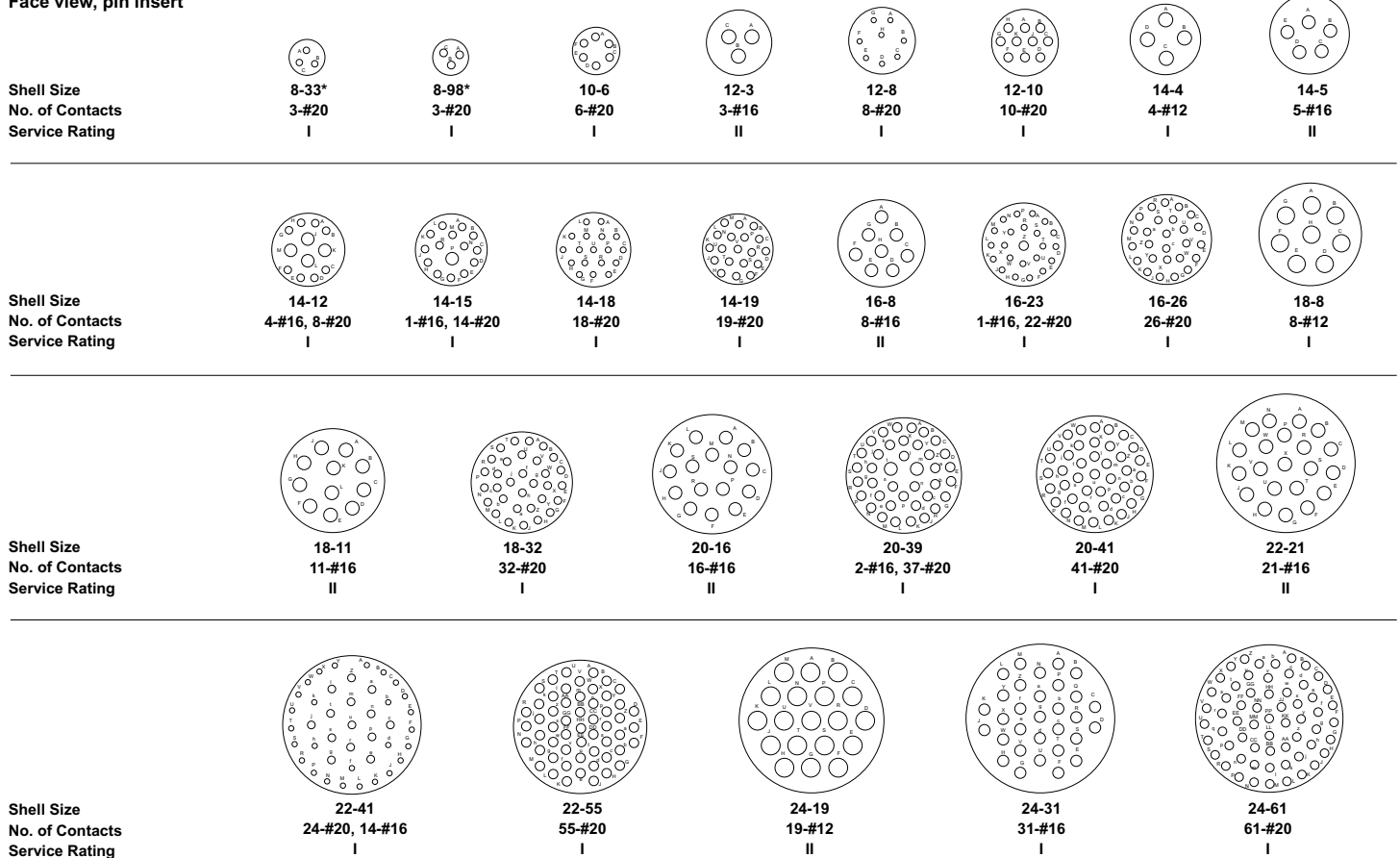

* Layouts are available in shell styles MS3470 and MS3476 only.

Alternate Insert Positions

Face view, pin insert

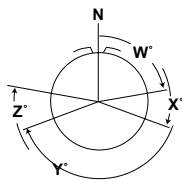

Contact arrangements requiring reduced diameter for lead-in chamfer on outer row of contact cavities as indicated below.

Shell	Contact Arrangements	Contact Cavities
8	33, 38	A, B, C
12	10	C, G
14	12	A, B, C, D, E, F, G, and H
14	18	A, C, E, G, J, and L
14	19	B, D, F, H, K, and M
16	26	A, B, C, D, E, F, G, H, J, K, L, M, N, P, and R)
18	32	A, B, C, D, E, F, G, H, J, K, L, M, N, P, R, S, and T
22	41	A, B, C, D, E, F, G, H, J, K, L, M, N, P, R, S, T, U, V, W, X, and Y

SHELL SIZE	ARRANGEMENT	POS CODE				
		N	W	X	Y	Z
8	33	0°	90°	-	-	-
	98	0°	-	-	-	-
10	6	0°	90°	-	-	-
	3	0°	-	-	180°	-
12	8	0°	90°	112°	203°	292°
	10	0°	60°	155°	270°	295°
14	4	0°	45°	-	-	-
	5	0°	40°	92°	184°	273°
	12	0°	43°	90°	-	-
	15	0°	17°	110°	155°	234°
	18	0°	15°	90°	180°	270°
16	19	0°	30°	165°	315°	-
	8	0°	54°	152°	180°	331°
	23	0°	158°	270°	-	-
	26	0°	60°	-	275°	338°
18	8	0°	180°	-	-	-
	11	0°	62°	119°	241°	340°
20	32	0°	85°	138°	222°	265°
	16	0°	238°	318°	333°	347°
	39	0°	63°	144°	252°	333°
22	41	0°	45°	126°	225°	-
	21	0°	16°	135°	175°	349°
	41	0°	39°	135°	264°	-
24	55	0°	30°	142°	226°	314°
	19	0°	30°	165°	315°	-
	31	0°	90°	225°	225°	-
24	61	0°	90°	180°	270°	324°

Thru-Bulkhead Receptacle

PV-TBF

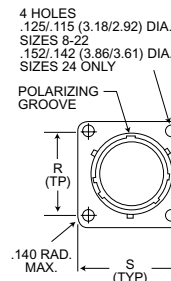
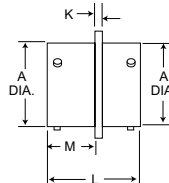
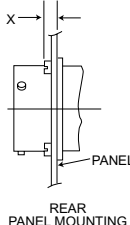
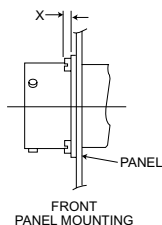

Shell Size	A Dia ±.003 (0.08)	K ±.016 (0.41)	L Max.	M ±.016 (0.41)	R (TP)	S Max.	X Max.
8	.471 (11.96)	.062 (1.57)	1.125 (28.58)	.577 (14.66)	.594 (15.09)	.828 (21.03)	.218 (5.54)
10	.588 (14.94)	.062 (1.57)	1.125 (28.58)	.577 (14.66)	.719 (18.26)	.954 (24.23)	.218 (5.54)
12	.748 (19.00)	.062 (1.57)	1.125 (28.58)	.577 (14.66)	.812 (20.62)	1.047 (26.59)	.218 (5.54)
14	.873 (22.17)	.062 (1.57)	1.125 (28.58)	.577 (14.66)	.906 (23.01)	1.141 (28.98)	.218 (5.54)
16	.998 (25.35)	.062 (1.57)	1.125 (28.58)	.577 (14.66)	.969 (24.61)	1.234 (31.34)	.218 (5.54)
18	1.123 (28.52)	.062 (1.57)	1.125 (28.58)	.577 (14.66)	1.062 (26.97)	1.328 (33.73)	.218 (5.54)
20	1.248 (31.70)	.094 (2.39)	1.406 (35.71)	.703 (17.86)	1.156 (29.36)	1.453 (36.91)	.344 (8.74)
22	1.373 (34.87)	.094 (2.39)	1.406 (35.71)	.703 (17.86)	1.250 (31.75)	1.578 (40.08)	.344 (8.74)
24	1.498 (38.05)	.094 (2.39)	1.406 (35.71)	.703 (17.86)	1.375 (34.92)	1.703 (43.26)	.311 (7.90)

Notes: 1) Shell available in conductive (nickel finish) only. 2) Contacts are nonremovable.

How to Order - PV-TBF

SERIES PREFIX

PV-TBF - ITT Cannon prefix

SHELL SIZE

8 through 24

INSERT ARRANGEMENTS

10-6, 14-19, 16-8, 16-26, 18-32, 20-39, 20-41, 22-41, 22-55, 24-61.

SERIES PREFIX

SHELL SIZE

INSERT ARRANGEMENTS

CONTACT STYLE

ALTERNATE POLARIZING POSITION

CONTACT STYLE

Pin and socket

ALTERNATE POLARIZING POSITION

No designation required for normal. Standard MS alternate positions available.

Notes: 1) Shell available in conductive (nickel finish) only.
2) Contacts are nonremovable.
3) Designed to MS3119 configuration and meets the performance requirements of MIL-C-26482 Series 2.

PV-TBF 10 -6 PS W

Tooling



Crimp Tool
M22520/1-01 Crimp Tool with M22520/1-02 Turret



Insertion/Extraction Tools



CBT 520/530

Contact Size	Wire Contact Tools					Unwired Contact Tools Cannon Pt. No.
	Cannon Part Number	M81969 Part Number	Insertion Color Tip	Extraction Color Tip	Superseded Mil. Pt. No.	
20	CIET-20-11 (274-7001-006)	M81969/14-11	Red	White	MS27534-20, MS3447-20, NAS1664-20	274-7007-000
16	CIET-16-03 (274-7002-000)	M81969/14-03	Blue	White	MS27534-16, MS3447-16, NAS1664-16	274-7008-000
12	CIET-12-04 (274-7003-000)	M81969/14-04	Yellow	White	MS27534-12, MS3447-12, NAS1664-12	274-7009-000

Panel Cutouts

Jam Nut Receptacle

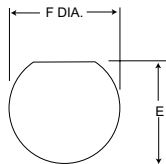

Narrow Flange and Thru-Bulkhead/Wide Flange

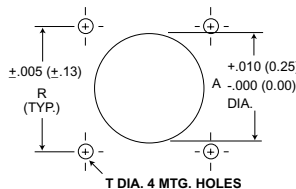

Shell Size	E ±.005 (0.13)	F Dia. ±.005 (0.13)
10	.661 (16.79)	.697 (17.70)
12	.824 (20.93)	.895 (22.73)
14	.948 (24.08)	1.010 (25.65)
16	1.072 (27.23)	1.135 (28.33)
18	1.197 (30.40)	1.260 (32.00)
20	1.322 (33.58)	1.385 (35.18)
22	1.447 (36.75)	1.510 (38.35)
24	1.572 (39.93)	1.635 (41.53)

Shell Size	Flange Front and Rear Mounting		Mounting Hole	
	A Dia.	R	T Dia.	Screw Size
8	.620 (15.75)	.594 (18.26)	.125 (3.14)	#4
10	.740 (18.80)	.719 (18.26)	.125 (3.17)	#4
12	.864 (21.95)	.812 (20.62)	.125 (3.17)	#4
14	.990 (25.15)	.906 (23.01)	.125 (3.17)	#4
16	1.118 (28.40)	.969 (24.61)	.125 (3.17)	#4
18	1.240 (31.50)	1.062 (26.97)	.125 (3.17)	#4
20	1.366 (34.70)	1.156 (29.36)	.125 (3.17)	#4
22	1.490 (37.85)	1.250 (31.75)	.125 (3.17)	#4
24	1.616 (41.05)	1.375 (34.92)	.155 (3.97)	#6

Shell Size	Flange Front and Rear Mounting		Mounting Hole	
	A Dia.	R	T Dia.	Screw Size
10	.740 (18.80)	.812 (20.62)	.155 (3.97)	#6
12	.864 (21.95)	.938 (23.93)	.155 (3.97)	#6
14	.990 (25.15)	1.031 (26.19)	.155 (3.97)	#6
16	1.118 (28.40)	1.125 (28.58)	.155 (3.97)	#6
18	1.240 (31.50)	1.203 (30.56)	.155 (3.97)	#6
20	1.366 (34.70)	1.297 (32.94)	.155 (3.97)	#6
22	1.490 (37.85)	1.375 (34.92)	.155 (3.97)	#6
24	1.616 (41.05)	1.500 (38.10)	.155 (3.97)	#6

Panel Thickness

Shown here are the maximum panel thickness including screw head height allowable to ensure complete connector operation.

Narrow Flange Receptacle

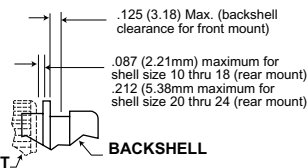

Wide Flange Receptacle

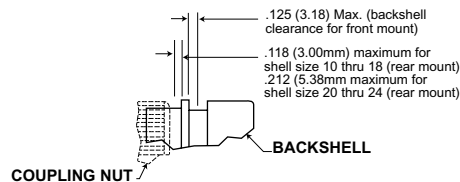

Dummy Stowage Receptacles

How to Order

PV DESCRIPTION

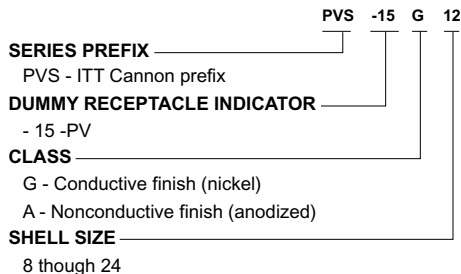

MS DESCRIPTION

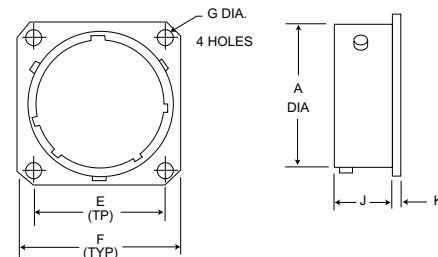
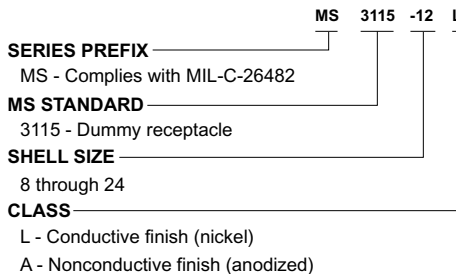

NOTE: Usable on KPT/KPSE series also.

Shell Size	A Dia. Max.	E (TYP)	F Max.	G Max.	J Max.	K Max.
8	.474 (12.04)	.594 (15.09)	.828 (21.03)	.125 (3.18)	.493 (12.52)	.078 (1.98)
10	.591 (15.01)	.719 (18.26)	.954 (24.23)	.125 (3.18)	.493 (12.52)	.078 (1.98)
12	.751 (19.08)	.812 (20.62)	1.047 (26.59)	.125 (3.18)	.493 (12.52)	.078 (1.98)
14	.876 (22.25)	.906 (23.01)	1.141 (28.98)	.125 (3.18)	.493 (12.52)	.078 (1.98)
16	1.001 (25.43)	.969 (24.61)	1.234 (31.34)	.125 (3.18)	.493 (12.52)	.078 (1.98)
18	1.126 (28.60)	1.062 (26.97)	1.328 (33.73)	.125 (3.18)	.493 (12.52)	.078 (1.98)
20	1.251 (31.78)	1.156 (29.36)	1.453 (36.91)	.125 (3.16)	.587 (14.91)	.110 (2.79)
22	1.376 (34.95)	1.250 (31.75)	1.578 (40.08)	.125 (3.18)	.587 (14.91)	.110 (2.79)
24	1.501 (38.13)	1.375 (34.92)	1.703 (43.26)	.152 (3.86)	.620 (15.75)	.110 (2.79)

Protective Metal Caps

Plugs

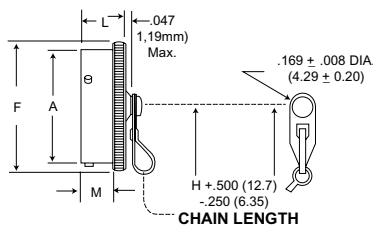

Receptacles

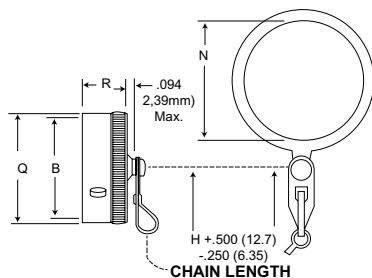

SERIES PREFIX

PVS - ITT Cannon Prefix
MS - Complies with MIL-C-26482 (Series 2)

TYPE

80 or 3180 - Plug Cap
81 or 3181 - Receptacle Cap

SHELL SIZE

8 thru 24

TERMINATION STYLE

C - Sash chain (MS approved)
N - Sash chain with ring (81 or 3181 type only) MS approved

FINISH

A - Hard anodic, non-conductive (MS approved)
G - Nickel, conductive (not MS) (PVS only)

NOTE: Usable on KPT/KPSE series also.
N style used primarily on Jam Nut Receptacle.

PVS 80 -12 C A
MS 3180 -12 C A

Shell Size	A Max. Dia.	B Max.	F Max. Dia.	H	L Max.	M Max.	N Min. Dia.	Q Max.	R Max.
8	.474 (12.04)	.486 (12.34)	.719 (18.26)	3.000 (76.20)	.562 (14.27)	.399 (10.13)	.578 (14.68)	.734 (18.64)	.562 (14.27)
10	.591 (15.01)	.607 (15.42)	.844 (21.44)	3.000 (76.20)	.562 (14.27)	.399 (10.13)	.703 (17.86)	.859 (21.82)	.562 (14.27)
12	.751 (19.08)	.766 (19.46)	1.000 (25.40)	3.500 (76.20)	.562 (14.27)	.399 (10.13)	.891 (22.63)	1.000 (25.40)	.562 (14.27)
14	.876 (22.25)	.890 (22.60)	1.125 (28.58)	3.500 (88.90)	.562 (14.27)	.399 (10.13)	1.016 (25.81)	1.125 (28.58)	.562 (14.27)
16	1.001 (25.43)	1.015 (25.78)	1.250 (31.75)	3.500 (88.90)	.562 (14.27)	.399 (10.13)	1.141 (28.98)	1.250 (31.75)	.562 (14.27)
18	1.126 (28.60)	1.141 (28.98)	1.375 (34.93)	3.500 (88.90)	.562 (14.27)	.399 (10.13)	1.266 (32.16)	1.375 (34.93)	.562 (14.27)
20	1.251 (31.78)	1.265 (32.13)	1.500 (38.10)	4.000 (101.60)	.625 (15.88)	.461 (11.71)	1.391 (35.33)	1.500 (38.10)	.562 (14.27)
22	1.376 (34.96)	1.390 (35.31)	1.625 (41.26)	4.000 (101.60)	.625 (15.88)	.461 (11.71)	1.516 (38.51)	1.625 (41.26)	.562 (14.27)
24	1.501 (38.13)	1.515 (38.48)	1.750 (44.45)	4.000 (101.60)	.658 (16.71)	.494 (12.55)	1.641 (41.68)	1.750 (44.45)	.602 (15.29)

Contacts

Contact Size	Type	M39029 Number	Color Brands			ITT Cannon
			1st	2nd	3rd	
20	Socket	M39029/5-115	Brown	Brown	Green	031-9174-004
20	Pin	M39029/4-110	Brown	Brown	Black	030-9173-006
16	Socket	M39029/5-116	Brown	Brown	Blue	031-9206-006
16	Pin	M39029/4-111	Brown	Brown	Brown	030-9205-007
12	Socket	M39029/5-118	Brown	Brown	Grey	031-9186-003
12	Pin	M39029/4-113	Brown	Brown	Orange	030-9185-003

Thermocouple Contacts

Contact Size	Alumel	Chromal
20 Pin	030-1831-000	030-1832-000
20 Socket	031-1013-000	031-1014-000

Contacts for printed circuit applications are also available. Consult factory.

Wire Hole Fillers



Contact Size	Part Number		Superseded Mil. Pt. No.	Color Code
	Cannon	Military		
20	225-0070-000	MS27488-20	MS3187-20 M83723/28-20	Red
16	225-0071-000	MS27488-16	MS3187-16 M83723/28-16	Blue
12	225-0072-000	MS27488-12	MS3187-12 M83723/28-12	Yellow

Assembly Procedures

STRIPPING AND CRIMPING

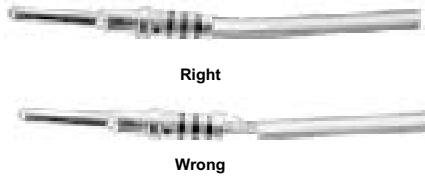

1. Strip wires according to contact size: 3/16" for #20 and 9/32" for #16 and #12. #20 contacts accommodate AWG wire sizes 20, 22, or 24; #16 accommodates 16, 18 or 20; and #12 accommodates 12 or 14.

2. Insert wire into rear of contact. Wire insulation must butt against rear of contact. Wire must be visible thru inspection hole.

3. Use M22520/1-01 crimp tool with proper crimp locator M22520/1-02. The color code hand on the contact (red for #20, blue for #16 and yellow for #12) must match the color code of the locator and the insertion tool throughout the crimping and assembly operations.



CONTACT INSERTION



OPENING

COLORED END FOR INSERTION

4. Insert contact and wire into tool jaws. To crimp, squeeze handles together fully until ratchet release and allows handles to expand; otherwise, contact cannot be extracted from tool jaws. Maintain slight insertion pressure on wire while crimping contact to wire.

1. Remove backshell and put wired contacts thru cable clamp opening.

2. Used colored end of CIET tool for insertion. Place wire into tool at large opening. To facilitate contact insertion, a 6-in. min. free length of wire is recommended.

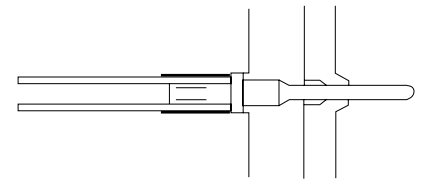

3. Slide back tool on wire while holding thumb against wire at opening. Wire will slip into tool.

NOTE: Socket contacts should be inserted partially into grommet by hand before using insertion tool.

4. With tool pressed against shoulder of contact, starting at the center cavity, insert wired contact and tool into properly identified cavity at rear of plug with firm, even pressure. Do not use excessive pressure.

5. When contact bottoms, a slight click can be heard as tines of metal retaining clip snaps into place behind contact shoulder.



6. Withdraw tool from rear of plug. To be sure that contact is locked, pull back lightly on wire. Then remove tool from wire and proceed with other contacts.

7. After all contacts are inserted, fill unwired cavities with sealing plugs (insert head last and leave end protruding for ease of removal), assemble backshell on rear of connector.

CONTACT EXTRACTION



1. Remove backshell and slide back along wires to allow access. To extract a contact, use white end of CIET tool. Place wire into tool at large opening. Slide back tool on wire while holding thumb against wire at opening. Wire will slip into tool.

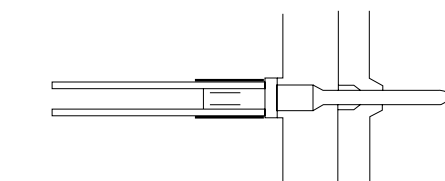

2. Push tool into rear of plug until it bottoms. At this point, tool releases tines on retaining clip so that contact can be extracted.

3. While maintaining slight insertion force on tool, firmly hold wire against serrated shoulder at center of tool and extract both wired contact and tool from plug.

COMPLETION

BROKEN CIRCLE

BREAK

4. Check face of plug or receptacle for proper contact installation. In socket inserts with a large number of contact, cavities are identified in a spiral pattern. A projecting line from the spiral indicates omission of a letter; a broken circle around a cavity indicates transition between capitals and lower case and double letters.

ITT Cannon is the foremost manufacturer of MS and MS type connectors with the widest range of connector styles, sizes and variations in the industry. These connectors utilize the finest materials, which, along with precision manufacturing and rigid quality control, assure ITT Cannon customers of the finest quality connectors.

These circular connectors were originally designed for aircraft, but are now widely used in many other fields. They are particularly suitable for commercial applications requiring low cost and high reliability.



ENVIRONMENTAL RESISTANT MS-E, MS-F, MS-R AND F80 (Solder/Crimp Termination)

MS-E, MS-F and MS-R are similar to MS-A and MS-B connectors but have resilient insulators and wire sealing grommets for extreme environmental conditions and high altitude sealing. MS-E's and MS-F's have a mechanical cable clamp; the MS-R has a shorter, lighter weight endbell without the cable clamp. Both the MS-F and MS-R have 0 rings to supplement the interfacial seal. Shells are aluminum alloy. Contacts are silver plated copper alloy. The F80 modification (crimp contact termination) is available in E, R, F and BFR styles with resilient insulators.

POTTING ER CONNECTORS (Solder Contact Termination)

These lightweight potting connectors provide resistance to salt water, fuels, etc., and will withstand the effects of high vibration. 3100 and 3106 connectors with plastic potting cups and resilient inserts meet the requirements of MS3103 and MS25183. Contacts are silver plated copper or brass. ER insulators are resilient; shells are aluminum alloy. A 90° plug (3108ER) is also available.



ACCESSORIES

Accessories to fit MS connectors include junction shells, protective caps, dummy or stowage receptacles, cable clamps, telescoping bushings.

How to Order

In the latest revision of MIL-C-5015, a new class of environment-resistant connectors was added. This new class F connector supersedes the previous class E connector. The MS3106F is identical to the MS3106E except that the MS3106F has an "0" ring under the coupling nut. The class E will still be available upon request for existing programs, and upon ordering will also bear the E nomenclature on the shell.

MS-F and MS-R connectors are designed to operate in the extreme environmental conditions of high altitude flight and must be completely sealed to withstand moisture, condensation, vibration, corona and flashover caused by high altitude environments. They have resilient grommet with internal restrictions in the wire cavities which act as 0 rings around the wires. This allows the wires to slide thru the grommet with a minimum of friction, yet when the ferrule is seated and the endbell tightened it provides a perfect wire seal thru a wide variety of wire diameters. This seal at the rear, plus the interfacial seal at the front, effects a completely environment-resistant assembly when the plug is mated to an F or R receptacle. Sockets are of the closed-entry type.

The temperature range for this connector is -55°C (-67°F) to +125°C (+257°F) and meets the requirements of MIL-C-5015.

The F80 modification (crimp contact termination) is available in resilient insulators in the E, R, F, and BFR styles, creating a large selection of insert assemblies and hardware. Components are identical to the MS-5015 except that the contacts are modified for crimp termination providing an inexpensive crimp contact connector with the proven reliability of and complete interchangeability with the MS-5015 series. See page 187 for assembly instructions. Cable clamps have been integrally designed with the endbell on MS-E and MS-F connectors. Class R is without the cable clamp.

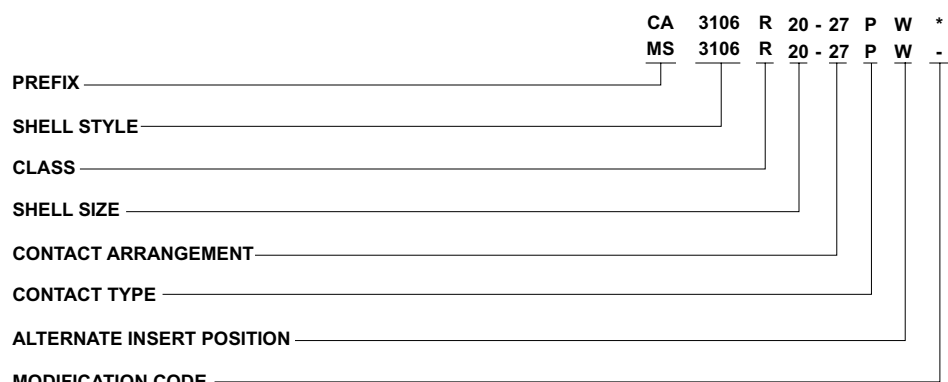

- PREFIX**
- SHELL STYLE**
- CLASS**
- SHELL SIZE**
- CONTACT ARRANGEMENT**
- CONTACT TYPE**
- ALTERNATE INSERT POSITION**
- MODIFICATION CODE**
- PREFIX**
 - MS - Conforms to latest MIL-C-5015 revision
 - CA - Cannon designation (for any modification)
- SHELL STYLE**
 - 3100 - Wall mounting receptacle
 - 3101 - Cable connecting plug
 - 3102 - Box mounting receptacle
 - * 3106 - Straight plug
 - 3108 - 90° angle plug
- CLASS**
 - E/F - Environmental with resilient insulators and integral cable clamp.
 - R - Environmental with resilient insulators and shortened light weight endbell; also additional sealing with 0 ring seal under coupling nut in styles 3106 and 3108

- SHELL SIZE**
 - Coupling thread diameter in sixteenths of an inch
- CONTACT ARRANGEMENTS**
 - See pages 171-174
- CONTACT TYPE**
 - P for Pin; S for Socket
- ALTERNATE INSERT POSITION**
 - W, X, Y and Z (omit for "Normal")
- MODIFICATION CODE**
 - (applies to CA numbers only, not MS)
 - F80 - Crimp type contacts. See page 187 for assembly instructions.

* When ordering MS3106F to the Cannon part number, designate CA06R. See pages 177 and 181.

Performance and Material Specifications

MATERIALS AND FINISHES

Shell	Material	Aluminum alloy
	Finish	O.D. Chromate coating over cadmium plating
Insulator	Material	Polychloroprene (resilient)
Contacts	Material	Brass or copper alloy
	Finish	Silver plate
	Termination	Tinned solder pot

WIRING

For class E, R and F connectors, satisfactory moisture sealing will be obtained if AWG and MS wire sizes and insulation outside diameters are governed by this table.

Contact Size	Wire Size (MIL-W-5086)	Insulation OD Limit (inches)
16	16 thru 20	.064 (1.63) min. to .130 (3.30) max.
12	12 thru 14	.114 (2.90) min. to .170 (4.32) max.
8	8 thru 10	.164 (4.17) min. to .255 (6.48) max.
4	4 thru 6	.275 (6.98) min. to .370 (9.40) max.
0	0 thru 2	.415 (10.54) min. to .550 (13.97) max.

ELECTRICAL SERVICE DATA

Test current ratings of contacts and allowable voltage drop under test conditions when assembled as in service are shown below. Maximum total current to be carried per connector is the same as the allowable in wire bundles as specified in MIL-W-5088.

Contact Size	Test Current (amps)	Potential Drop (millivolts)
16	13	49
12	23	42
8	46	26
4	80	23
0	150	21

CONTACTS

Pin and socket contacts are designed to resist severe vibration and repeated connection and disconnection. The average force to either engage or separate pin and socket contacts will not exceed the average values given in the latest revision of MIL-C-5015.

FORCE In lbs.	Contact Sizes				
	16	12	8	4	0
Maximum	3.00	5.00	10.00	15.00	20.00
Average	2.10	3.50	7.00	10.50	14.00
Minimum	.25	.50	.75	1.00	2.00

THERMOCOUPLE CONTACTS

Sizes 12 and 16 contacts, machined from matching thermocouple lead wire alloys, can be supplied in ITT Cannon connectors. These thermocouple contacts maintain continuity from thermal-sensor leads thru a bulkhead of other closures in temperature measuring applications.

These contacts for matching lead wires are detailed by the standards of the Instrument Society of America (I.S.A.);

I.S.A Standards	Material
J and Y	Iron and constantan
K	Chromel and alumel
T	Copper and constantan

Since the thermocouple connector applications determines the soldering methods and materials to be used, thermocouple contacts, identified by permanent markings, are normally supplied with untinned solder pots. Thermocouple contacts are supplied only in connectors having resilient insulators.

HIGH POTENTIAL TEST VOLTAGE

MS connectors show no evidence of breakdown when the test voltage given below is applied between the two closest contacts and between the shell and the contacts closest to the shell for a period of one minute.

MS Service Rating	Test Voltage (RMS) 60 cps	Suggested * Operating Voltages		Air Spacing Nom. (inches)	Creepage Distance Nom. (inches)
		DC	AC (rms)		
Inst.	1000	250	200		1/16
A	2000	700	500	1/16	1/8
D	2800	1250	900	1/8	3/16
E	3500	1750	1250	3/16	1/4
B	4500	2450	1750	1/4	5/16
C	7000	4200	3000	5/16	1

* As indicated in previous MS Specification and to be used by designer only as a guide.

High Voltage Cartridges for MS-E and MS-R (HV310*E/R Series)



- Standard contact arrangements are adaptable to high voltage applications.
- Eliminates need for a separate high voltage connector.
- Assembly time is reduced.

High voltage conductors as well as power and/or control signal conductors can now be connected simultaneously in standard MS connectors. Previously, MS connectors involved in high voltage circuitry required individual design considerations and could only be ordered as a "special." The new high voltage cartridge allows conversion of a standard connectors to one capable of handling up to 15,000 volts DC (Test Voltage - mated), operating voltage - See level 5,000 VDC or 3,500 VAC. These cartridges are molded of nylon and provide as high degree of arc-over protection between adjacent contacts or between a contact and the connector shell. Unmated, each cartridge provides a nylon isolating barrier capable of withstanding up to 10,000 volts DC (or peak).

The contact within the cartridge is a 7.5 amp. size 20, crimp snap-in type with dielectric rear release clip retention. This contact is removable with the plastic CIET20 insertion/extraction tool provided the insulation is .084 (22.45) or less. The contact may be crimped with the standard MS-3191 tool and MS-3191-20A locator and hand inserted into the nylon cartridge. The cartridge body is installed in the connector at the factory.

High voltage cartridges now available fit the space normally occupied by a #4 or #8 size contact in an MS-E, MS-R or MS-F type connector.

Over forty-nine contact arrangements are currently available in which these high voltage cartridges may be used. Consult factory for ordering information.

MS Alternate Insert Positions

All views are looking into front of pin insert of rear of socket insert.



Normal Position

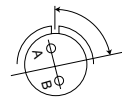

Position W

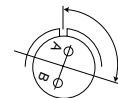

Position X

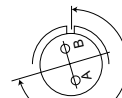

Position Y

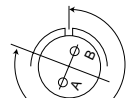

Position Z

Contact								Contact								Contact																																
Shell Size	Arrangement	Wire Size	Service Rating	Alternate Positions-Degrees				Shell Size	Arrangement	Wire Size	Service Rating	Alternate Positions-Degrees				Shell Size	Arrangement	Wire Size	Service Rating	Alternate Positions-Degrees																												
				W	X	Y	Z					W	X	Y	Z					W	X	Y	Z																									
8S	8S-1	1 #16	A	-	-	-	-	20	20-22	3 #16	A	80	110	250	280	28	28-10	3 #12	D(G)	80	110	250	280																									
10S	10S-2	1 #16	A	-	-	-	-	20-23	2 #8	A	35	110	250	325	28-11	18 #16	A	80	110	250	280	28-12	26 #16	A	90	180	270	-																				
	10SL-4	2 #16	A	-	-	-	-																						20-24	2 #16	A	35	110	250	325	4 #12	A	80	110	250	280	28-15	35 #16	A	80	110	250	280
	10SL-3	3 #16	A	-	-	-	-																																									
12	12-5	1 #12	D	-	-	-	-	22	22-2	3 #8	D	70	145	215	290	* 28-17	15 #16	A(A-L),B(R)	80	110	250	280	28-21	37 #16	A	80	110	250	280																			
12S	12S-4	1 #16	D	-	-	-	-	* 22-4	2 #12	A	35	110	250	325	* 28-19															6 #16	A(C,E,G,J,K,L)	80	110	250	280	28-22	3 #4	D(M-P)	70	145	215	290						
	12S-3	2 #16	A	70	145	215	290	22-5	4 #16	D	35	110	250	325		28-20	4 #16	A	80	110	250	280	* 32-1	3 #12	E(A)	80	110	250	280																			
14	14-3	1 #8	A	-	-	-	-	22-6	1 #16	D	80	110	250	280	* 32-6															16 #16	A	80	110	250	280	32-7	28 #16	Inst. (A,B,h,j)	80	125	235	280						
14S	14S-1	3 #16	A	-	-	-	-	* 22-6	2 #8	D	80	110	250	280		32-8	24 #16	A	80	125	235	280	* 32-9	12 #16	D	80	110	250	280																			
	14S-2	4 #16	Inst.	-	120	240	-	22-7	1 #0	E	-	-	-	-	32-15															2 #0	D	35	110	250	280	32-17	4 #4	D	45	110	250	-						
	14S-5	5 #16	Inst.	-	110	-	-	22-9	3 #12	E	70	145	215	290		* 36-4	3 #0	A(B,C)	70	145	215	290	36-5	4 #0	A	-	120	240	-																			
	14S-6	6 #16	Inst.	-	-	-	-	22-10	4 #16	E	35	110	250	325	36-6															4 #4	A	35	110	250	325	36-7	40 #16	A	80	110	250	280						
	14S-7	3 #16	A	90	180	270	-	22-11	2 #16	B	35	110	250	325		36-8	46 #16	A	80	110	250	280	36-9	14 #16	A	80	125	235	280																			
	14S-9	2 #16	A	70	145	215	290	22-12	3 #16	D	80	110	250	280	36-10															48 #16	A	80	125	235	280	* 36-15	35 #16	D (m)	60	125	245	305						
16	16-9	2 #16	A	35	110	250	325	22-13	1 #16	A(A-D)	35	110	250	280		40-10	16 #16	A	65	125	225	310	* 40-56	85 #16	A	72	144	216	288																			
	16-10	3 #12	A	90	180	270	-	22-14	19 #16	A	80	-	-	280	44-1															36 #16	6 #12	D	65	125	225	310	48-5	90 #16	A	65	125	225	310					
	16-12	1 #4	A	-	-	-	-	* 22-15	1 #16	A(A-C,E,F)	80	110	250	280		48-5	1 #8	9 #12	D	80	110	250	280	48-5	1 #8	9 #12	A	65	125															225	310			
	16-11	2 #12	A	35	110	250	325	22-17	8 #16	E(D)	80	110	250	280	48-5															1 #8	9 #12	D	80	110	250	280	48-5	1 #8	9 #12	A	65	125	225			310		
	16-13	2 #12	A	35	110	250	325	22-18	8 #16	D(A)	80	110	250	280		48-5	1 #8	9 #12	D	80	110	250	280	48-5	1 #8	9 #12	A	65	125															225	310			
	16S	16S-1	7 #16	A	80	-	-	280	22-19	14 #16	A	80	110	250	280															48-5	1 #8	9 #12	D	80	110	250	280	48-5	1 #8	9 #12	A	65	125			225	310	
* 16S-4		2 #16	D	35	110	250	325	22-20	9 #16	A	35	110	250	325	48-5	1 #8	9 #12	D	80	110	250	280	48-5	1 #8	9 #12	A	65	125	225															310				
16S-5		3 #16	A	70	145	215	290	22-22	4 #8	A	-	110	250	-																48-5	1 #8	9 #12	D	80	110	250	280	48-5	1 #8	9 #12	A	65	125		225	310		
16S-6		3 #16	A	90	180	270	-	22-23	8 #12	D(H)	35	-	250	-	48-5	1 #8	9 #12	D	80	110	250	280	48-5	1 #8	9 #12	A	65	125	225															310				
16S-8		5 #16	A	-	170	265	-	* 22-27	8 #16	A(all others)	80	-	250	280																48-5	1 #8	9 #12	D	80	110	250	280	48-5	1 #8	9 #12	A	65	125		225	310		
18		18-1	10 #16	A(B,C,F,G)	70	145	215	290	22-28	7 #12	A	80	-	-	280	48-5	1 #8	9 #12	D	80	110	250	280	48-5	1 #8	9 #12	A	65	125															225			310	
	18-3	2 #12	D	35	110	250	325	24-2	7 #12	D	80	-	-	280	48-5															1 #8	9 #12	D	80	110	250	280	48-5	1 #8	9 #12	A	65	125	225		310			
	18-4	4 #16	D	35	110	250	325	* 24-5	16 #16	A	80	110	250	280		48-5	1 #8	9 #12	D	80	110	250	280	48-5	1 #8	9 #12	A	65	125															225		310		
	18-5	1 #16	D	80	110	250	280	* 24-6	8 #12	D(A,G,H)	80	110	250	280	48-5															1 #8	9 #12	D	80	110	250	280	48-5	1 #8	9 #12	A	65	125	225		310			
	18-7	1 #8	B	-	-	-	-	24-7	14 #16	A	80	110	250	280		48-5	1 #8	9 #12	D	80	110	250	280	48-5	1 #8	9 #12	A	65	125															225		310		
	18-8	7 #16	A	70	-	-	290	* 24-9	2 #4	A	35	110	250	325	48-5															1 #8	9 #12	D	80	110	250	280	48-5	1 #8	9 #12	A	65	125	225		310			
18-9	5 #16	Inst.	80	110	250	280	24-10	7 #8	A	80	-	-	280	48-5		1 #8	9 #12	D	80	110	250	280	48-5	1 #8	9 #12	A	65	125	225															310				
18-10	4 #12	A	-	120	240	-	* 24-11	6 #12	A	35	110	250	325		48-5															1 #8	9 #12	D	80	110	250	280	48-5	1 #8	9 #12	A	65	125	225		310			
18-11	5 #12	A	-	170	265	-	24-12	3 #12	A	80	110	250	280	48-5		1 #8	9 #12	D	80	110	250	280	48-5	1 #8	9 #12	A	65	125	225															310				
18-12	6 #16	A	80	-	-	280	24-20	9 #16	D	80	110	250	280		48-5															1 #8	9 #12	D	80	110	250	280	48-5	1 #8	9 #12	A	65	125	225		310			
* 18-13	3 #12	A	80	110	250	280	24-22	2 #12	D	45	110	250	-	48-5		1 #8	9 #12	D	80	110	250	280	48-5	1 #8	9 #12	A	65	125	225															310				
* 18-15	4 #12	A	-	120	240	-	24-24	24 #16	Inst.	80	110	250	280		48-5															1 #8	9 #12	D	80	110	250	280	48-5	1 #8	9 #12	A	65	125	225		310			
18-19	10 #16	A	-	120	240	-	28	28-1	6 #12	D(A,E,J)	80	110	250	280		48-5	1 #8	9 #12	D	80	110	250	280	48-5	1 #8	9 #12	A	65																				

ITT Cannon Designated Alternate Insert Positions

Not MS approved

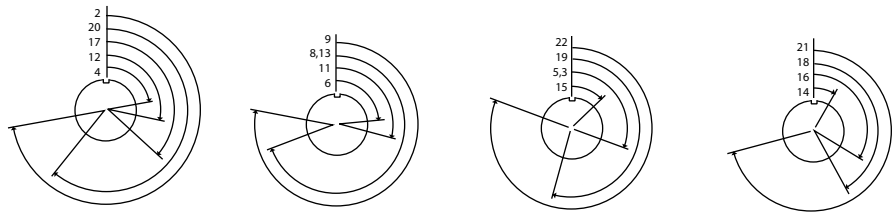

NOTE: Front view of pin insulator rotates as shown.

Shell Size	Contact Arrangement	Wire Size	Service Rating	Available Position						
				2	3	5	8	12	13	
10SL	10SLA4	5 #20	A	2	3	5	8	12	13	
12S	12SA10	4 #16	Inst.	3	5	8	13			
20	20A37	4 #8	D							
24	24A24	12 #12	A	2	4	9	12			
28	28A16	5 #16	A	2	3	5	8	9	13	
	28A51	4 #4								
32	32A10	43 #16	A	3	4	5	8	9	12	13
	32A47	54 #16	A	2	3	4	5	8	9	12
36	36A16	47 #16	A	2	3	4	5	8	9	12
	36A34	18 #12	A	2	3	4	5	8	9	12
	36A46	52 #16	A	2	3	4	5	8	9	12
	36A66	27 #12	A	2	3	4	5	8	9	12
40	40A27	52 #16	A	2	3	5	8	9	13	17
	40A33	4 #12								
		60 #16	A	4	14	17	20	22		
		7 #8	A	2	3	5	8	13		
		6 #4								

Note: For ITT Cannon contact arrangements not listed, consult factory.

Position	Angle (degrees)
Normal	0
2	260
3	110
4	80
5	use pos. 3
6	85
8	250
9	280
11	105
12	100
13	use pos. 8
14	30
15	45
16	120
17	130
18	150
19	195
20	220
21	255
22	290
23	165
24	330
25	235
26	125

Contact Arrangements (Face View Pin Insert)

LEGEND

- Resilient only
- ▲ Resilient & Plastic

⌀ High Volume Layouts - readily available from Cannon Distributors

Shell Size	8S-1	10S-2	10SL-4	10SL-3	10SLA4	12S-4	12-5	12S-3	12SA10	14-3	14S-9
No. of Contacts	1 #16	1 #16	2 #16	3 #16	5 #20	1 #16	1 #12	2 #16	4 #16	1 #8	2 #16
Service Rating	A	A	A	A	A	D	D	A	Inst.	A	A
Shell Size	14S-1	14S-7	14S-2	14S-5	14S-6	16-12	16-11	16S-4	16-13		
No. of Contacts	3 #16	3 #16	4 #16	5 #16	6 #16	1 #4	2 #12	2 #16	2 #12		
Service Rating	A	A	Inst.	Inst.	Inst.	A	A	D	(A-Iron B-Constantan)	A	
Shell Size	16S-5	16S-6	16-10	16-9	16S-8	16S-1	18-7	18-3			
No. of Contacts	3 #16	3 #16	3 #12	2 #16 (B,D) 2 #12 (A,C)	5 #16	7 #16	1 #8	2 #12			
Service Rating	A	A	A	A	A	A	B	D			
Shell Size	18-5	18-22	18-4	18-10	18-13	18-15	18-11	18-12			
No. of Contacts	1 #16(A) 2 #12(B,C)	3 #16	4 #16	4 #12	3 #12 (B,C,C) 1 #8(A)	4 #12	5 #12	6 #16			
Service Rating	D	D	D	A	A	(A, C-Iron; B, D-Constantan)	A	A	A		
Shell Size	18-9	18-8	18-1	18-19	20-2	20-23	20-3	20-19			
No. of Contacts	5 #16(B,C,E-G) 2 #12(A,D)	7 #16(A-G) 1 #12(H)	10 #16	10 #16	1 #0	2 #8	3 #12	3 #8			
Service Rating	Inst.	A	A(B,C,F,G) Inst. (all others)	A	D	A	D	A			
Shell Size	20-4	20-24	20A37	20-14	20-8	20-17	20-22	20-15			
No. of Contacts	4 #12	2 #16 (A,C) 2 #8 (B,D)	ITT Cannon pos. #8 of 20-4	3 #12(C,D,E) 2 #8(A,B)	4 #16(B,C,E,F) 2 #8(A,D)	1 #16(F) 5 #12(A-E)	3 #16(B,D,F) 3 #8(A,C,E)	7 #12			
Service Rating	D	A	D	A	Inst.	A	A	A			

Contact Arrangements (Continued)

LEGEND

- Resilient only
- ▲ Resilient & Plastic
- ⌀ High Volume Layouts - readily available from Cannon Distributors

Shell Size	20-7	20-16	20-18	20-33	20-11	20-27	20-29	22-7
No. of Contacts	8 #16	7 #16(A-G) 2 #12(H,I)	6 #16(A,C-E,G,H) 3 #12(B,F,I)	11 #16	13 #16	14 #16	17 #16	1 #0
Service Rating	A(C-F) D(A,B,G,H)	A	A	A	Inst.	A	A	E
Shell Size	22-11	22-2	22-6	22-9	22-4	22-10	22-22	22-12
No. of Contacts	2 #16	3 #8	1 #16(B) 2 #8(A,C)	3 #12	2 #12(A,C) 2 #8(B,D)	4 #16	4 #8	3 #16(A,C,D) 2 #8(B,E)
Service Rating	B	D	D	E	A	E	A	D
Shell Size	22-13	22-5	22-15	22-28	22-18	22-23	22-17	22-20
No. of Contacts	1 #16(E) 4 #12(A-D)	4 #16(A,C,D,F) 2 #12(B,E)	1 #16(D) 5 #12(A-C,E,F)	7 #12	8 #16	8 #12	8 #16(A-D,F-J) 1 #12(E)	9 #16
Service Rating	A(A-D), D(E)	D	A(A-C,E,F),E(D)	A	A(C-E) D(all others)	D(H) A(all others)	D(A), A(all others)	A
Shell Size	22-27	22-19	22-14	24-9	24-22	24-12	24-2	24-10
No. of Contacts	8 #16(A-H) 1 #8(J)	14 #16	19 #16	2 #4	4 #8	3 #12(B,D,E) 2 #4(A,C)	7 #12	7 #8
Service Rating	D(J), A (all others)	A	A	A	D	A	D	A
Shell Size	24-27	24-6	24-11	24-20	24-19	24A24	24-5	24-7
No. of Contacts	7 #16	8 #12	6 #12(A-C,G-I) 3 #8(D-F)	9 #16(A-D,G-L) 2 #12(E,F)	12 #16	12 #12	16 #16	14 #16(A-M,O) 2 #12(P,N)
Service Rating	E	D(A,G,H) A(all others)	A	D	A	A	A	A

Contact Arrangements (Continued)

LEGEND

- Resilient only
- ▲ Resilient & Plastic

∅ High Volume Layouts - readily available from Cannon Distributors

Shell Size	24-28	28-7	28-22	28-10	28-1	28A16	28-19
No. of Contacts	24 #16	2 #4	3 #16(D-F) 3 #4(A-C)	3 #12(A,F,G) 2 #8(B,E) 2 #4(C,D)	6 #12(A,B,D-F,H) 3 #8(C,J,G)	5 #16(A,D-F,J) 4 #4(B,C,G,H)	6 #16(A-C,H,L,M) 4 #12(E,G,J,K)
Service Rating	Inst.	D	D	D(G), A(all others)	D(A,E,J) A(all others)	A	A(C,E,G,J,K,L) B(H,M),D(A,B)

Shell Size	28-9	28-2	28-20	28-17	28-16	28-11	28-12
No. of Contacts	6 #16(A,H-M) 6 #12(B-G)	12 #16(A,L,N) 2 #12(M,P)	4 #16(K-N) 10 #12(A-J,P)	15 #16	20 #16	18 #16(A-I, N-X) 4 #12(J-M)	26 #16
Service Rating	D	D	A	A(A-L), B(R) D(M-P)	A	A	A

Shell Size	28-15	28-21	28A51	32-17	32-1	32-15	32-9
No. of Contacts	35 #16	37 #16	43 #16	4 #4	3 #12(A,C,D) 2 #0(B,E)	2 #0(A,G) 6 #12(B,C,D,E,F,H)	12 #16(C-N) 2 #4(A,B)
Service Rating	A For MIL equip design, use 28-21	A	A	D	E(A),D(all others)	D	D

Shell Size	32-6	32-8	32-7	32A47	32A10	36-4
No. of Contacts	16 #16(A-O,S) 2 #12(U,V) 3 #8(P,R,T) 2 #4(W,X)	24 #16(A-L,T-Z,a-e) 6 #12(M-S) 2 #8(O,R)	28 #16(A-N,W-Z,a-k) 7 #12(O-V)	47 #16	54 #16	3 #0
Service Rating	A	A For new MIL equip. design, use 32-7	Inst. (A,B,h,j) A(all others)	A	A	A(B,C),C(A)

*NOTE: Additional layouts are the same as shown but in unique alternate positions. Please consult the factory.

Contact Arrangements (Continued)

LEGEND

- Resilient only
- ▲ Resilient & Plastic

ϕ High Volume Layouts - readily available from Cannon Distributors

† Grommet not available. Consult factory for ordering connectors with this arrangement.

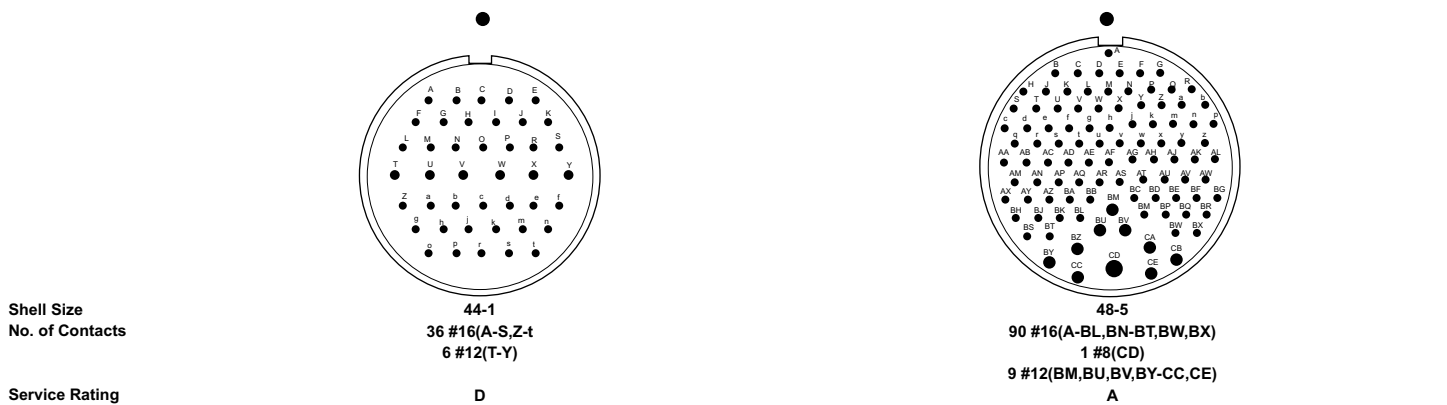
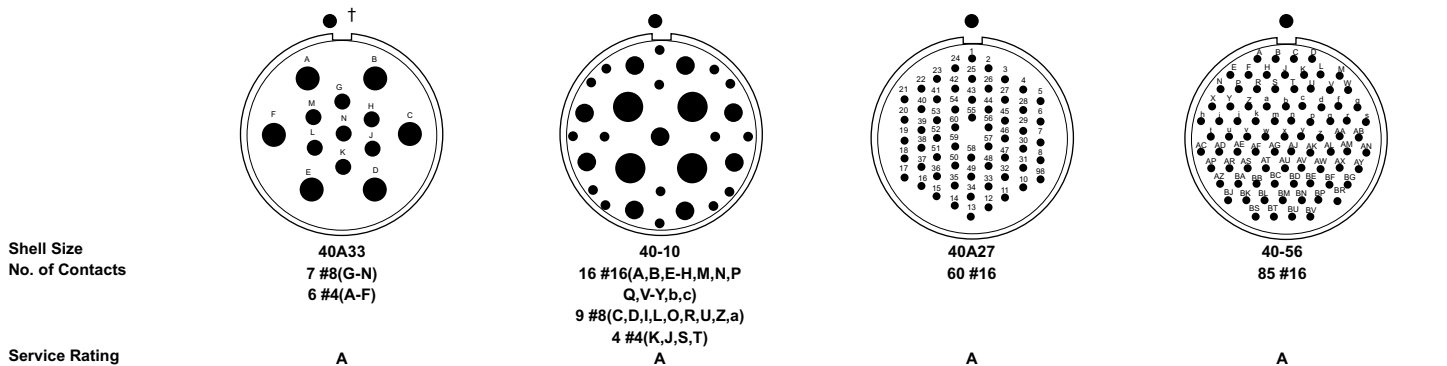
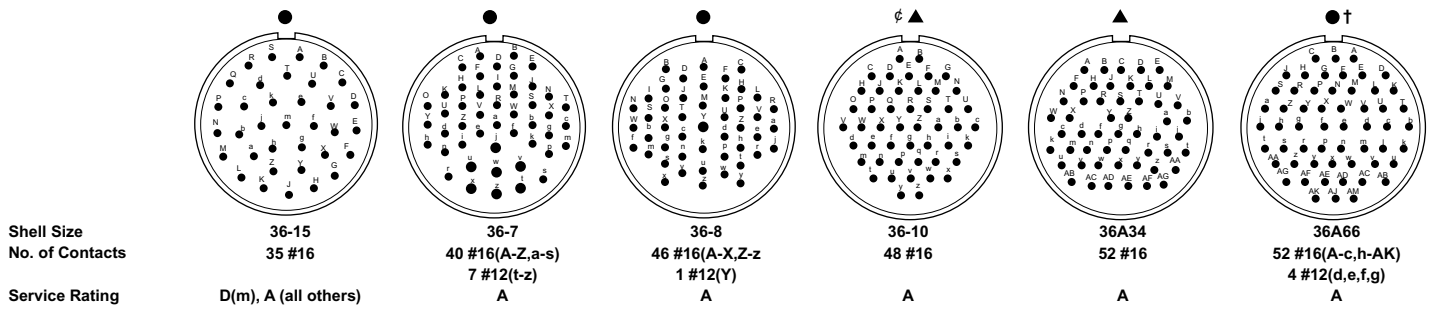
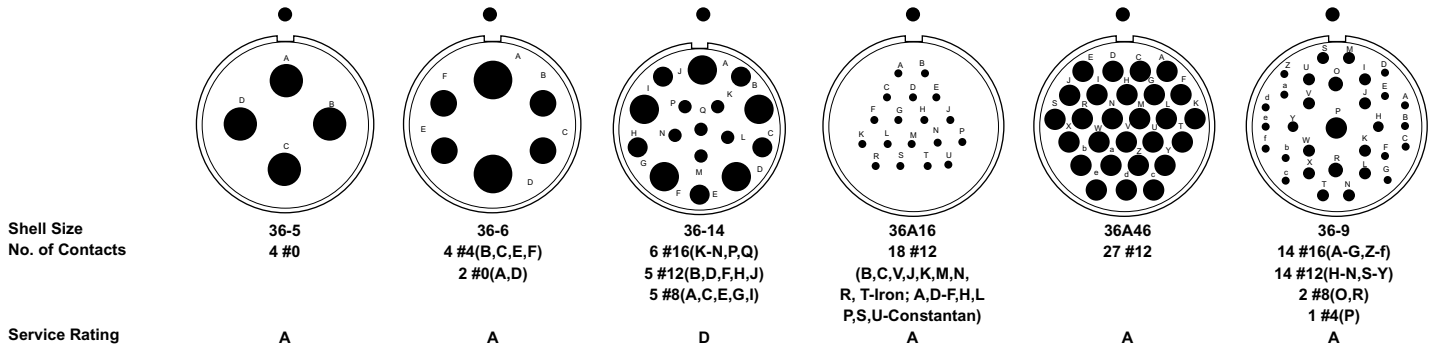

Cable Connecting Plug (Receptacle with no mounting flange)

MS3101E/MS3101F
Integral Cable Clamp



CA3101E/CA3101E

MS3101E cable connecting plugs are used for cable extension requirements, where mounting provisions are unnecessary.

MS3101E plugs mate with 3106, 3107 and 3108 plugs. Note: the D revision of MIL-C-5015 has changed the nomenclature of the 3101 from receptacle to plug.

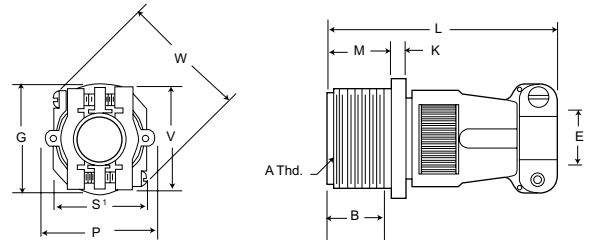

MS3101R



CA3101R

MS3101R cable connecting plug is identical in purpose to the MS3101E. The MS3101R features a shorter lightweight endbell and mates with 3106, 3107 and 3108 plugs. Note: The D revision of the MIL-C-5015 specification has changed the nomenclature of the 3101 from receptacle to plug.

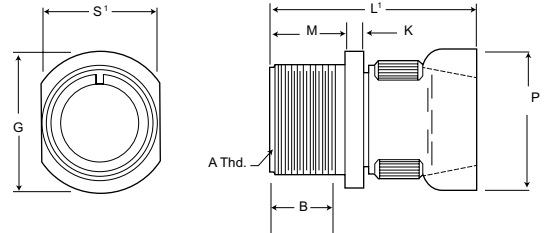

Shell Size	B Min.	E Max.	E Min.	G Max.	K Max.	L Max.	L' Max.	M +0.031(0.79) -0.000(0.00)	P Max.	S' Max.	V Max.	W Max.
8S	.375 (9.53)	.235 (5.97)	.102 (2.59)	.844 (21.44)	.125 (3.18)	2.250 (57.15)	1.838 (46.69)	.562 (14.27)	.890 (22.61)	.515 (13.08)	.840 (21.34)	1.046 (26.57)
10S	.375 (9.53)	.235 (5.97)	.102 (2.59)	.969 (24.61)	.125 (3.18)	2.250 (57.15)	1.838 (46.69)	.562 (14.27)	.890 (22.61)	.640 (16.26)	.840 (21.34)	1.046 (26.57)
10SL	.375 (9.53)	.297 (7.54)	.140 (3.56)	1.062 (26.97)	.125 (3.18)	2.250 (57.15)	1.838 (46.69)	.562 (14.27)	.970 (24.64)	.640 (16.26)	.900 (22.86)	1.125 (28.58)
12S	.375 (9.53)	.297 (7.54)	.140 (3.56)	1.062 (26.97)	.140 (3.56)	2.250 (57.15)	1.838 (46.69)	.562 (14.27)	.970 (24.64)	.765 (19.43)	.900 (22.86)	1.125 (28.58)
14S	.375 (9.53)	.422 (10.72)	.195 (4.95)	1.156 (29.36)	.140 (3.56)	2.250 (57.15)	1.838 (46.69)	.562 (14.27)	1.150 (29.21)	.890 (22.61)	1.00 (27.94)	1.343 (34.11)
16S	.375 (9.53)	.547 (13.89)	.255 (6.48)	1.281 (32.54)	.140 (3.56)	2.250 (57.15)	1.838 (46.69)	.562 (14.27)	1.250 (31.75)	1.015 (25.78)	1.200 (30.48)	1.484 (37.69)
12	.625 (15.88)	.297 (7.54)	.140 (3.56)	1.062 (26.97)	.146 (3.71)	2.625 (66.68)	2.181 (55.40)	.750 (19.05)	.970 (24.64)	.765 (19.43)	.900 (22.86)	1.125 (28.58)
14	.625 (15.88)	.422 (10.72)	.195 (4.95)	1.156 (29.36)	.146 (3.71)	2.625 (66.58)	2.181 (55.40)	.750 (19.05)	1.150 (29.21)	.890 (22.61)	1.100 (27.94)	1.343 (34.11)
16	.625 (15.88)	.547 (13.89)	.255 (6.48)	1.281 (32.54)	.146 (3.71)	2.625 (66.58)	2.181 (55.40)	.750 (19.05)	1.250 (31.75)	1.015 (25.78)	1.200 (30.48)	1.484 (37.69)
18	.625 (15.88)	.610 (15.49)	.285 (7.24)	1.344 (34.14)	.180 (4.57)	2.688 (68.28)	2.281 (55.40)	.750 (19.05)	1.450 (36.83)	1.140 (28.96)	1.300 (33.02)	1.609 (40.87)
20	.625 (15.88)	.735 (18.67)	.350 (8.89)	1.500 (38.10)	.180 (4.57)	2.750 (69.85)	2.281 (55.40)	.750 (19.05)	1.570 (39.88)	1.265 (32.13)	1.500 (38.10)	1.890 (48.01)
22	.625 (15.88)	.740 (18.80)	.350 (8.89)	1.625 (41.28)	.180 (4.57)	2.750 (69.85)	2.281 (55.40)	.750 (19.05)	1.570 (39.88)	1.390 (35.31)	1.500 (38.10)	1.890 (48.01)
24	.625 (15.88)	.922 (23.42)	.468 (11.89)	1.750 (44.45)	.203 (5.16)	2.969 (75.44)	2.281 (55.40)	.812 (20.62)	1.880 (47.75)	1.515 (38.48)	1.740 (44.20)	2.170 (55.12)
28	.625 (15.88)	.922 (23.42)	.468 (11.89)	2.000 (50.80)	.203 (5.16)	3.031 (76.99)	2.281 (55.40)	.812 (20.62)	1.880 (47.75)	1.765 (44.83)	1.740 (44.20)	2.170 (55.12)
32	.625 (15.88)	1.235 (31.37)	.664 (15.87)	2.250 (57.15)	.203 (5.16)	3.031 (76.99)	2.322 (58.98)	.875 (22.23)	2.205 (56.01)	2.015 (51.18)	2.075 (52.71)	2.656 (67.46)
36	.625 (15.88)	1.360 (34.54)	.694 (17.63)	2.500 (63.50)	.203 (5.16)	3.281 (83.34)	2.322 (58.98)	.875 (22.23)	2.400 (60.96)	2.270 (57.66)	2.300 (58.42)	2.922 (74.22)
*40	.625 (15.88)	1.628 (41.35)	.911 (23.14)	2.750 (69.85)	.203 (5.16)	3.560 (89.66)†	2.427 (61.65)†	.875 (22.23)	2.840 (72.14)	2.427 (61.65)	2.688 (68.28)	-

†Not to MS specification

*Not Available in MS3101E and MS3101R.

Shell Size	A Thread
8S	1/2-28UNEF-2A
10S	5/8-24UNEF-2A
10SL	5/8-24UNEF-2A
12S	3/4-20UNEF-2A
14S	7/8-20UNEF-2A
16S	1-20UNEF-2A
12	3/4-20UNEF-2A
14	7/8-20UNEF-2A

Shell Size	A Thread
16	1-20UNEF-2A
18	1-1/8-18UNEF-2A
20	1-1/4-18UNEF-2A
22	1-3/8-18UNEF-2A
24	1-1/2-18UNEF-2A
28	1-3/4-18UNS-2A
32	2-18UNS-2A
36	2-1/4-16UN-2A
40	2-1/2-16UN-2A

Performance Specifications - Page 168

Contact, Sealing Plugs, Assembly Tools - Page

187

Contact Arrangements - Page 171-174

Wall Mounting Receptacle

MS3100E/MS3100F
Integral Cable Clamp



CA3100E/CA3100E MS3100F wall mounting receptacles are used to carry wires thru walls or bulkheads, or to provide a means of disconnection at a bulkhead. MS3100F receptacles mate with 3106 and 3108 plugs. MS3100E is identical to MS3100F and is available upon request. For new equipment, customer should specify MS3100F.

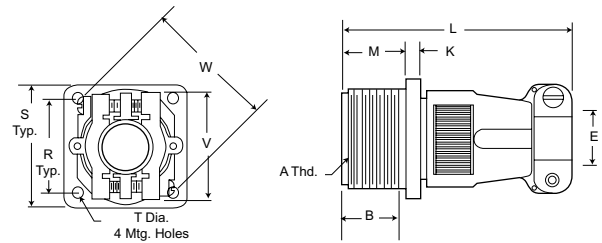

MS3100R



CA3100R The MS3100R receptacle is identical in purpose to the MS3100F. The MS3100R features a shorter light weight endbell and mates with 3106 and 3108 plugs.

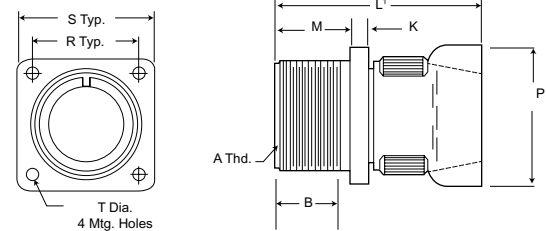

Shell Size	B Min.	E Max.	E Min.	K Max.	L Max.	L' Max.	M +.031 -0.000	P Max.	R ±.005	S ±.031	T +.010 -0.005	V Max.	W Max.
8S	.375 (9.53)	.235 (5.97)	.102 (2.59)	.125 (3.18)	2.250 (57.15)	1.838 (46.69)	.562 (14.27)	.890 (22.61)	.594 (15.09)	.875 (22.23)	.120 (3.05)	.840 (21.34)	1.046 (26.57)
10S	.375 (9.53)	.235 (5.97)	.102 (2.59)	.125 (3.18)	2.250 (57.15)	1.838 (46.69)	.562 (14.27)	.890 (22.61)	.719 (18.26)	1.000 (25.40)	.120 (3.05)	.840 (21.34)	1.046 (26.57)
10SL	.375 (9.53)	.297 (7.54)	.140 (3.56)	.125 (3.18)	2.250 (57.15)	1.838 (46.69)	.562 (14.27)	.970 (24.64)	.719 (18.26)	1.000 (25.40)	.120 (3.05)	.900 (22.86)	1.125 (28.58)
12S	.375 (9.53)	.297 (7.54)	.140 (3.56)	.140 (3.56)	2.250 (57.15)	1.838 (46.69)	.562 (14.27)	.970 (24.64)	.812 (20.62)	1.094 (27.79)	.120 (3.05)	.900 (22.86)	1.125 (28.58)
14S	.375 (9.53)	.422 (10.72)	.195 (4.95)	.140 (3.56)	2.250 (57.15)	1.838 (46.69)	.562 (14.27)	1.150 (29.21)	.906 (23.01)	1.188 (30.18)	.120 (3.05)	1.100 (27.94)	1.343 (34.11)
16S	.375 (9.53)	.547 (13.89)	.255 (6.48)	.140 (3.56)	2.250 (57.15)	1.838 (46.69)	.562 (14.27)	1.250 (31.75)	.969 (24.61)	1.281 (32.54)	.120 (3.05)	1.200 (30.48)	1.484 (37.69)
12	.625 (15.88)	.297 (7.54)	.140 (3.56)	.146 (3.71)	2.625 (66.68)	2.181 (55.40)	.750 (19.05)	.970 (24.64)	.812 (20.62)	1.094 (27.79)	.120 (3.05)	.900 (22.86)	1.125 (28.58)
14	.625 (15.88)	.422 (10.72)	.195 (4.95)	.146 (3.71)	2.625 (66.58)	2.181 (55.40)	.750 (19.05)	1.150 (29.21)	.906 (23.01)	1.188 (30.18)	.120 (3.05)	1.100 (27.94)	1.343 (34.11)
16	.625 (15.88)	.547 (13.89)	.255 (6.48)	.146 (3.71)	2.625 (66.58)	2.181 (55.40)	.750 (19.05)	1.250 (31.75)	.969 (24.61)	1.281 (32.54)	.120 (3.05)	1.200 (30.48)	1.484 (37.69)
18	.625 (15.88)	.610 (15.49)	.285 (7.24)	.180 (4.57)	2.688 (68.28)	2.281 (55.40)	.750 (19.05)	1.450 (36.83)	1.062 (26.97)	1.375 (34.93)	.120 (3.05)	1.300 (33.02)	1.609 (40.87)
20	.625 (15.88)	.735 (18.67)	.350 (8.89)	.180 (4.57)	2.750 (69.85)	2.281 (55.40)	.750 (19.05)	1.570 (39.88)	1.156 (29.36)	1.500 (38.10)	.120 (3.05)	1.500 (38.10)	1.890 (48.01)
22	.625 (15.88)	.740 (18.80)	.350 (8.89)	.180 (4.57)	2.750 (69.85)	2.281 (55.40)	.750 (19.05)	1.570 (39.88)	1.250 (31.75)	1.625 (41.28)	.120 (3.05)	1.500 (38.10)	1.890 (48.01)
24	.625 (15.88)	.922 (23.42)	.468 (11.89)	.203 (5.16)	2.969 (75.44)	2.281 (55.40)	.812 (20.62)	1.880 (47.75)	1.375 (34.93)	1.750 (44.45)	.147 (3.73)	1.740 (44.20)	2.170 (55.12)
28	.625 (15.88)	.922 (23.42)	.468 (11.89)	.203 (5.16)	3.031 (76.99)	2.281 (55.40)	.812 (20.62)	1.880 (47.75)	1.562 (39.67)	2.000 (50.80)	.147 (3.73)	1.740 (44.20)	2.170 (55.12)
32	.625 (15.88)	1.235 (31.37)	.664 (15.87)	.203 (5.16)	3.031 (76.99)	2.322 (58.98)	.875 (22.23)	2.205 (56.01)	1.750 (44.45)	2.250 (57.15)	.173 (4.39)	2.075 (52.71)	2.656 (67.46)
36	.625 (15.88)	1.360 (34.54)	.694 (17.63)	.203 (5.16)	3.281 (83.34)	2.322 (58.98)	.875 (22.23)	2.400 (60.96)	1.938 (49.23)	2.500 (63.50)	.173 (4.39)	2.300 (58.42)	2.922 (74.22)
*40	.625 (15.88)	1.628 (41.35)	.911 (23.14)	.203 (5.16)	3.560 (89.66)†	2.427 (61.65)†	.875 (22.23)	2.840 (72.14)	2.188 (55.58)	2.750 (69.85)	.173 (4.39)	2.688 (68.28)	-

†Not to MS specification

*Not Available in MS3101E and MS3101R.

Shell Size	A Thread
8S	1/2-28UNEF-2A
10S	5/8-24UNEF-2A
10SL	5/8-24UNEF-2A
12S	3/4-20UNEF-2A
14S	7/8-20UNEF-2A
16S	1-20UNEF-2A
12	3/4-20UNEF-2A
14	7/8-20UNEF-2A

Shell Size	A Thread
16	1-20UNEF-2A
18	1-1/8-18UNEF-2A
20	1-1/4-18UNEF-2A
22	1-3/8-18UNEF-2A
24	1-1/2-18UNEF-2A
28	1-3/4-18UNEF-2A
32	2-18UNEF-2A
36	2-1/4-16UNEF-2A
40	2-1/2-16UNEF-2A

Performance Specifications - Page 168

Contact, Sealing Plugs, Assembly Tools - Page

187

Contact Arrangements - Page 171-174

Straight Plug

MS3106E/MS3106F
Integral Cable Clamp



CA3106E/CA06R

MS3106F straight plugs mate with 3100 and 3102 receptacles and 3101 plugs.

The MS3106E is available upon request. For new equipment, customer should specify MS3106F. MS3106E is identical to MS3106F except to O ring under the coupling nut.

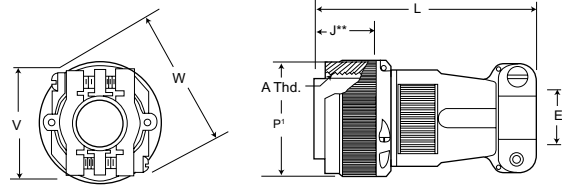

MS3106R



CA3106R

The MS3106R straight plug is identical in purpose to the MS3106F. The MS3106R has the shorter endbell. This plug will mate with 3100 and 3102 receptacles and 3101 plugs.

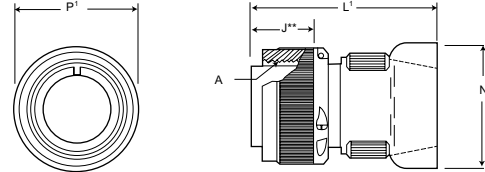

Shell Size	E Max.	E Min.	J** Max.	L Max.	L' Max.	N Max.	P1 Max.	V Max.	W Max.
8S	.235 (5.97)	.102 (2.59)	.536 (13.61)	2.250 (57.15)	1.838 (46.69)	.890 (22.61)	.844 (21.44)	.840 (21.34)	1.046 (26.57)
10S	.235 (5.97)	.102 (2.59)	.536 (13.61)	2.250 (57.15)	1.838 (46.69)	.890 (22.61)	.969 (24.61)	.840 (21.34)	1.046 (26.57)
10SL	.297 (7.54)	.140 (3.56)	.536 (13.61)	2.250 (57.15)	1.838 (46.69)	.970 (24.64)	.969 (24.61)	.900 (22.86)	1.125 (28.58)
12S	.297 (7.54)	.140 (3.56)	.536 (13.61)	2.250 (57.15)	1.838 (46.69)	.970 (24.64)	1.062 (26.97)	.900 (22.86)	1.125 (28.58)
14S	.422 (10.72)	.195 (4.95)	.536 (13.61)	2.250 (57.15)	1.838 (46.69)	1.150 (29.21)	1.156 (29.36)	1.00 (27.94)	1.343 (34.11)
16S	.547 (13.89)	.255 (6.48)	.536 (13.61)	2.250 (57.15)	1.838 (46.69)	1.250 (31.75)	1.250 (31.75)	1.200 (30.48)	1.484 (37.69)
12	.297 (7.54)	.140 (3.56)	.724 (18.39)	2.625 (66.68)	2.181 (55.40)	.970 (24.64)	1.062 (26.97)	.900 (22.86)	1.125 (28.58)
14	.422 (10.72)	.195 (4.95)	.724 (18.39)	2.625 (66.68)	2.181 (55.40)	1.150 (29.21)	1.156 (29.36)	1.100 (27.94)	1.343 (34.11)
16	.547 (13.89)	.255 (6.48)	.724 (18.39)	2.625 (66.68)	2.181 (55.40)	1.250 (31.75)	1.250 (31.75)	1.200 (30.48)	1.484 (37.69)
18	.610 (15.49)	.285 (7.24)	.724 (18.39)	2.688 (68.28)	2.281 (55.40)	1.450 (36.83)	1.344 (34.14)	1.300 (33.02)	1.609 (40.87)
20	.735 (18.67)	.350 (8.89)	.724 (18.39)	2.750 (69.85)	2.281 (55.40)	1.570 (39.88)	1.469 (37.31)	1.500 (38.10)	1.890 (48.01)
22	.740 (18.80)	.350 (8.89)	.724 (18.39)	2.750 (69.85)	2.281 (55.40)	1.570 (39.88)	1.594 (40.49)	1.500 (38.10)	1.890 (48.01)
24	.922 (23.42)	.468 (11.89)	.724 (18.39)	2.969 (75.41)	2.281 (55.40)	1.880 (47.75)	1.719 (43.66)	1.740 (44.20)	2.170 (55.12)
28	.922 (23.42)	.468 (11.89)	.724 (18.39)	3.031 (76.99)	2.281 (55.40)	1.880 (47.75)	1.969 (50.01)	1.740 (44.20)	2.170 (55.12)
32	1.235 (31.37)	.664 (15.87)	.724 (18.39)	3.031 (76.99)	2.322 (58.98)	2.205 (56.01)	2.219 (56.36)	2.075 (52.71)	2.656 (67.46)
36	1.360 (34.54)	.694 (17.63)	.724 (18.39)	3.281 (83.34)	2.322 (58.98)	2.400 (60.96)	2.469 (62.71)	2.300 (58.42)	2.922 (74.22)
* 40	1.628 (41.35)	.911 (23.14)	.724 (18.39)	3.560 (89.66)†	2.427 (61.65)†	2.840 (72.14)	2.723 (69.16)†	2.688 (68.28)	-

†Not to MS specification

** Barrel engaging face to shoulder.

Shell Size	A Thread
8S	1/2-28UNEF-2B
10S	5/8-24UNEF-2B
10SL	5/8-24UNEF-2B
12S	3/4-20UNEF-2B
14S	7/8-20UNEF-2B
16S	1-20UNEF-2B
12	3/4-20UNEF-2B
14	7/8-20UNEF-2B

Shell Size	A Thread
16	1-20UNEF-2B
18	1-1/8-18UNEF-2B
20	1-1/4-18UNEF-2B
22	1-3/8-18UNEF-2B
24	1-1/2-18UNEF-2B
28	1-3/4-18UNS-2B
32	2-18UNS-2B
36	2-1/4-16UN-2B
40	2-1/2-16UN-2B

Performance Specifications - Page 168

Contact, Sealing Plugs, Assembly Tools - Page

187

Contact Arrangements - Page 171-174

Box Mounting Receptacle

MS3102E/MS3102R

CA3102E/CA3102R



MS3102E and MS3102R box mounting receptacles are used in junction boxes or as an integral part of equipment. These connectors are identical in construction and will mate with 3106, 3107 and 3108 plugs. For new equipment, customer should specify MS3102R.

Shell Size	X DIMENSION				
	Max. Solder Pot Ext. - Pin or Socket				
	Contact Size				
	16	12	8	4	0
8S, 10S, 10SL	.534	-	-	-	-
12S, 14S, 16S	.518	-	-	-	-
12	.705	.705	-	-	-
14	.705	.705	.767	-	-
16	.705	.705	.767	.767	-
18	.674	.674	.736	.736	-
20,22	.674	.674	.736	.736	.971
24,28	.612	.612	.674	.674	.909
32,36	.549	.549	.611	.611	.846

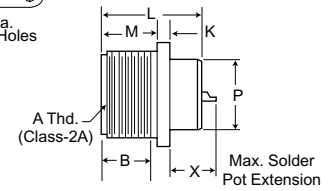
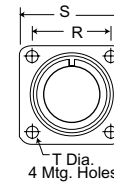

90° Angle Plug

MS3108E/MS3108R

CA3108E/CA3108R



MS3108R 90° angle plugs with O ring seal less cable clamp) and the MS3108E 90° angle plugs (less O ring seal with cable clamp) are used where there is limited space and where wires must be brought at abrupt angles. This plugs will mate with 3100 and 3102 receptacles and 3101 plugs.

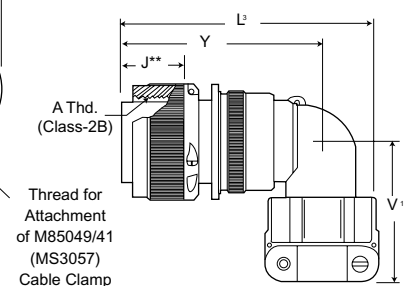
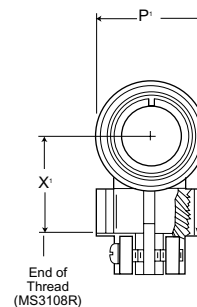

See page 185 for cable clamp dimensions.

Shell Size	B Min.	J** Max.	K Max.	L Max.	L' Max.	M +.031 (0.79) -.000 (0.00)	P Max.	P' Max.	R ±.005	S ±.031	T +.010 -.005	V' Max.	X' Max.	Y Max.
8S	.375 (9.53)	.536 (13.61)	.125 (3.18)	1.040 (26.42)	2.156 (54.76)	.562 (14.27)	.426 (10.82)	.844 (21.44)	.594 (15.09)	.875 (22.23)	.120 (3.05)	1.281 (30.94)	.811 (20.60)	1.640 (41.66)
10S	.375 (9.53)	.536 (13.61)	.125 (3.18)	1.040 (26.42)	2.156 (54.76)	.562 (14.27)	.520 (13.21)	.969 (24.61)	.719 (18.26)	1.000 (25.40)	.120 (3.05)	1.250 (31.75)	.842 (21.39)	1.640 (41.66)
10SL	.375 (9.53)	.536 (13.61)	.125 (3.18)	1.040 (26.42)	2.188 (55.58)	.562 (14.27)	.614 (15.60)	.969 (24.61)	.719 (18.26)	1.000 (25.40)	.120 (3.05)	1.281 (32.54)	.873 (22.17)	1.703 (43.26)
12S	.375 (9.53)	.536 (13.61)	.140 (3.56)	1.040 (26.42)	2.188 (55.58)	.562 (14.27)	.614 (15.60)	1.062 (26.97)	.812 (20.62)	1.094 (27.79)	.120 (3.05)	1.281 (32.54)	.873 (22.17)	1.703 (43.26)
14S	.375 (9.53)	.536 (13.61)	.140 (3.56)	1.040 (26.42)	2.312 (58.72)	.562 (14.27)	.739 (18.77)	1.156 (29.36)	.906 (23.01)	1.188 (30.18)	.120 (3.05)	1.406 (35.71)	.936 (23.77)	1.765 (44.83)
16S	.375 (9.53)	.536 (13.61)	.140 (3.56)	1.040 (26.42)	2.406 (61.11)	.562 (14.27)	.864 (21.95)	1.250 (31.75)	.969 (24.61)	1.281 (32.54)	.120 (3.05)	1.531 (38.89)	.998 (25.35)	1.796 (45.62)
12	.625 (15.88)	.724 (18.39)	.146 (3.71)	1.400 (35.56)	2.531 (64.29)	.750 (19.05)	.614 (15.60)	1.062 (26.97)	.812 (20.62)	1.094 (27.79)	.120 (3.05)	1.281 (32.54)	.873 (22.17)	2.062 (52.37)
14	.625 (15.88)	.724 (18.39)	.146 (3.71)	1.400 (35.56)	2.688 (68.28)	.750 (19.05)	.739 (18.77)	1.156 (29.36)	.906 (23.01)	1.188 (30.18)	.120 (3.05)	1.406 (35.71)	.936 (23.77)	2.125 (53.98)
16	.625 (15.88)	.724 (18.39)	.146 (3.71)	1.400 (35.56)	2.781 (70.64)	.750 (19.05)	.864 (21.95)	1.250 (31.75)	.969 (24.61)	1.281 (32.54)	.120 (3.05)	1.531 (38.89)	.998 (25.35)	2.156 (54.76)
18	.625 (15.88)	.724 (18.39)	.180 (4.57)	1.400 (35.56)	2.844 (72.24)	.750 (19.05)	.989 (25.12)	1.344 (34.14)	1.062 (26.97)	1.375 (34.93)	.120 (3.05)	1.593 (40.46)	1.061 (26.95)	2.250 (57.15)
20	.625 (15.88)	.724 (18.39)	.180 (4.57)	1.400 (35.56)	3.250 (82.55)	.750 (19.05)	1.145 (29.08)	1.469 (37.31)	1.156 (29.36)	1.500 (38.10)	.120 (3.05)	1.656 (42.06)	1.123 (28.52)	2.312 (58.72)
22	.625 (15.88)	.724 (18.39)	.180 (4.57)	1.400 (35.56)	3.250 (82.55)	.750 (19.05)	1.270 (32.26)	1.594 (40.49)	1.250 (31.75)	1.625 (41.28)	.120 (3.05)	1.718 (43.64)	1.186 (30.12)	2.312 (58.72)
24	.625 (15.88)	.724 (18.39)	.203 (5.16)	1.400 (35.56)	3.719 (94.46)	.812 (20.62)	1.395 (35.43)	1.719 (43.66)	1.375 (34.93)	1.750 (44.45)	.147 (3.73)	1.890 (48.01)	1.263 (32.08)	2.531 (64.29)
28	.625 (15.88)	.724 (18.39)	.203 (5.16)	1.400 (35.56)	3.719 (94.46)	.812 (20.62)	1.614 (41.00)	1.969 (50.01)	1.562 (39.67)	2.000 (50.80)	.147 (3.73)	1.968 (49.99)	1.342 (34.09)	2.531 (64.29)
32	.625 (15.88)	.724 (18.39)	.203 (5.16)	1.400 (35.56)	4.188 (106.38)	.875 (22.23)	1.864 (47.35)	2.219 (56.36)	1.750 (44.45)	2.250 (57.15)	.173 (4.39)	2.187 (55.55)	1.561 (39.65)	2.750 (69.85)
36	.625 (15.88)	.724 (18.39)	.203 (5.16)	1.400 (35.56)	4.297 (109.14)	.875 (22.23)	2.051 (52.10)	2.469 (62.71)	1.938 (49.23)	2.500 (63.50)	.173 (4.39)	2.406 (61.11)	1.780 (45.21)	2.875 (73.02)
40	.625 (15.88)	.724 (18.39)	.203 (5.16)	1.400 (35.56)	7.211 (183.16)†	.875 (22.23)	2.390 (60.71)	2.723 (69.16)†	2.188 (55.58)	2.750 (69.85)	.173 (4.39)	5.875 (149.22)	-	5.690 (144.53)

†Not to MS specification

** Barrel engaging face to shoulder.

Shell Size	A Thread	
	Box Mounting Receptacle	90° Angle Plug
8S	1/2-28UNEF-2A	1/2-28UNEF-2B
10S	5/8-24UNEF-2A	5/8-24UNEF-2B
10SL	5/8-24UNEF-2A	5/8-24UNEF-2B
12S	3/4-20UNEF-2A	3/4-20UNEF-2B
14S	7/8-20UNEF-2A	7/8-20UNEF-2B
16S	1-20UNEF-2A	1-20UNEF-2B
12	3/4-20UNEF-2A	3/4-20UNEF-2B
14	7/8-20UNEF-2A	7/8-20UNEF-2B

Shell Size	A Thread	
	Box Mounting Receptacle	90° Angle Plug
16	1-20UNEF-2A	1-20UNEF-2B
18	1-1/8-18UNEF-2A	1-1/8-18UNEF-2B
20	1-1/4-18UNEF-2A	1-1/4-18UNEF-2B
22	1-3/8-18UNEF-2A	1-3/8-18UNEF-2B
24	1-1/2-18UNEF-2A	1-1/2-18UNEF-2B
28	1-3/4-18UNS-2A	1-3/4-18UNS-2B
32	2-18UNS-2A	2-18UNS-2B
36	2-1/4-16UN-2A	2-1/4-16UN-2B
40	2-1/2-16UN-2A	2-1/2-16UN-2B

Performance Specifications - Page 168

Contact, Sealing Plugs, Assembly Tools - Page 187

187

Contact Arrangements - Page 171-174

How to Order

MS type potting connectors are available with nylon cups, 00 and 06 shell styles with plastic cups and resilient insulators meet the requirements of MS3103 and MS25183. Also available is the 08 plug with resilient insulator and 90° angle nylon potting cup.

ITT Cannon provides for a 1/4" clearance for potting on all contact sizes.

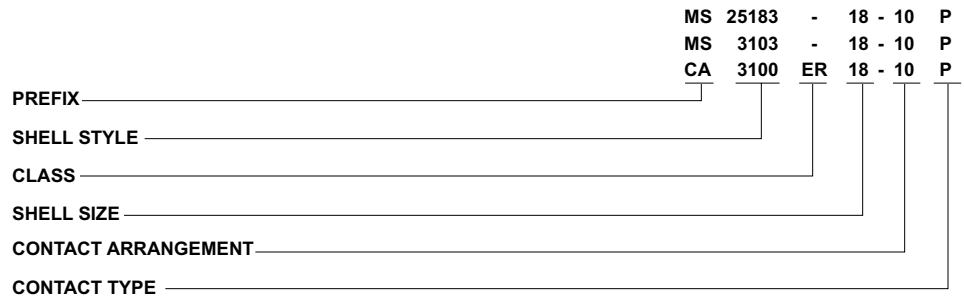

PREFIX
 CA - ITT Cannon prefix indicating special application or variation of MS

SHELL STYLE
 3100 - Wall mounting receptacle (MS3103)
 3106 - Straight plug (MS25183)
 3108 - 90° angle plug

CLASS
 ER - Resilient insulator, nylon potting cup and thread attachment ring
 No class designator for MS types.

SHELL STYLE
 Coupling thread diameter figured in sixteenths of an inch

COTNACT ARRANGEMENTS
 See pages 171-174

COTNACT TYPE
 P for Pin; S for Socket

Wall Mounting Receptacle

MS3103
 Nylon Potting Cup
 Threaded Attachment Ring



CA3100ER

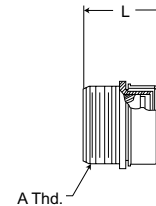
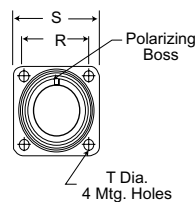

The CA3100ER receptacle (MS3103) is supplied with a resilient insulator and nylon potting cup with a threaded attachment ring. This receptacle mates with 3106, 3107, and 3108 plugs.

Shell Size	L Max.	R ±.005 (+0.13)	S Max.	R +.010 (+0.25) - .005 (+0.13)	A Thread
8S	1.531 (38.89)	.594 (15.09)	.906 (23.01)	.120 (3.05)	1/2-28UNEF-2A
10S	1.531 (38.89)	.719 (18.26)	1.031 (26.19)	.120 (3.05)	5/8-24NEF-2A
10SL	1.531 (38.89)	.719 (18.26)	1.031 (26.19)	.120 (3.05)	5/8-24NEF-2A
12S	1.531 (38.89)	.812 (20.62)	1.125 (28.58)	.120 (3.05)	3/4-20UNEF-2A
14S	1.531 (38.89)	.906 (23.01)	1.219 (30.96)	.120 (3.05)	7/8-20UNEF-2A
16S	1.531 (38.89)	.969 (24.61)	1.312 (33.32)	.120 (3.05)	1-20UNEF-2A
12	1.968 (49.99)	.812 (20.62)	1.125 (28.58)	.120 (3.05)	3/4-20UNEF-2A
14	1.968 (49.99)	.906 (23.01)	1.219 (30.96)	.120 (3.05)	3/4-20UNEF-2A
16	1.968 (49.99)	.968 (24.59)	1.312 (33.32)	.120 (3.05)	1-20UNEF-2A
18	1.968 (49.99)	1.062 (26.97)	1.406 (35.71)	.120 (3.05)	1-1/8-18NEF-2A
20	2.188 (55.58)	1.156 (29.36)	1.531 (38.89)	.120 (3.05)	1-1/4-18NEF-2A
22	2.188 (55.58)	1.250 (31.75)	1.656 (42.06)	.120 (3.05)	1-3/8-18NEF-2A
24	2.188 (55.58)	1.375 (34.92)	1.781 (45.24)	.147 (3.73)	1-1/2-18NEF-2A
28	2.188 (55.58)	1.562 (39.67)	2.031 (51.59)	.173 (4.39)	1-3/4-18NS-2A
32	2.188 (55.58)	1.750 (44.45)	2.281 (57.94)	.173 (4.39)	2-18NS-2A
36	2.188 (55.58)	1.938 (49.23)	2.531 (64.29)	.173 (4.39)	2-1/4-16UN-2A

Performance Specifications - Page 168

Contact, Sealing Plugs, Assembly Tools - Page 187

187

Contact Arrangements - Page 171-174

Straight Plug

MS25183
Nylon Potting Cup
Rubber Gasket

CA3106ER

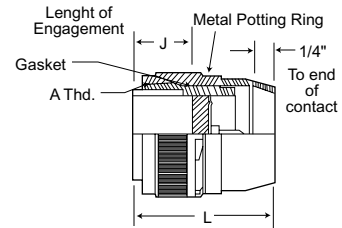
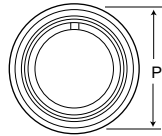

The CA3106ER plug is supplied with resilient insulators, nylon potting cups with threaded attachment rings, and a rubber gasket under the coupling nut. This plug mates with 3100 and 3102 receptacles and 3101 plugs.

90° Angle Plug

Nylon Potting Cup
Rubber Gasket

CA3108ER

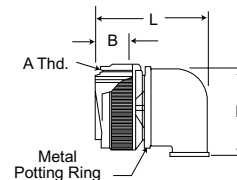
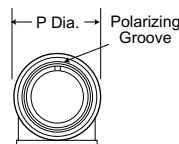

The CA3108ER is supplied with resilient insulator, 90° nylon potting cup and threaded attachment ring with a rubber gasket under the coupling nut. This plug mates with 3100 and 3102 receptacles and 3101 plugs.

CA3106ER

CA3108ER

Shell Size	J Max.	L Max.	P Max.	A Thread	L Max.					
					B Max.	D Max.	For Arr. w/#16 & #12 Contacts	For Arr. w/#8 & #4 Contacts	P Max.	A Thread
8S	.536 (13.61)	1.562 (39.67)	.844 (21.44)	1/2-28UNEF-2B	-	-	-	-	-	-
10S	.536 (13.61)	1.562 (39.67)	.969 (24.61)	5/8-24UNEF-2B	-	-	-	-	-	-
10SL	.536 (13.61)	1.562 (39.67)	.969 (24.61)	5/8-24UNEF-2B	.563 (13.61)	1.040 (26.42)	1.463 (37.16)	-	.969 (24.61)	5/8-24UNEF-2B
12S	.536 (13.61)	1.562 (39.67)	1.062 (26.97)	3/4-20UNEF-2B	.563 (13.61)	1.040 (26.42)	1.600 (40.64)	-	1.062 (26.97)	3/4-24UNEF-2B
14S	.536 (13.61)	1.562 (39.67)	1.156 (29.36)	7/8-20UNEF-2B	.563 (13.61)	1.040 (26.42)	1.600 (40.64)	2.300 (58.42)	1.156 (29.36)	7/8-20UNEF-2B
16S	.536 (13.61)	1.562 (39.67)	1.250 (31.75)	1-20UNEF-2B	.563 (13.61)	1.290 (32.77)	1.600 (40.64)	2.550 (64.77)	1.250 (31.75)	1-20UNEF-2B
12	.724 (18.39)	2.000 (50.80)	1.062 (26.97)	3/4-20UNEF-2B	.724 (18.39)	1.040 (26.42)	1.910 (48.51)	-	1.062 (26.97)	3/4-20UNEF-2B
14	.724 (18.39)	2.000 (50.80)	1.156 (29.36)	7/8-20UNEF-2B	.724 (18.39)	1.040 (26.42)	1.910 (48.51)	2.610 (66.29)	1.156 (29.36)	7/8-20UNEF-2B
16	.724 (18.39)	2.000 (50.80)	1.250 (31.75)	1-20UNEF-2B	.724 (18.39)	1.290 (32.77)	1.910 (48.51)	2.850 (72.39)	1.250 (31.75)	1-20UNEF-2B
18	.724 (18.39)	2.000 (50.80)	1.344 (34.14)	1-1/8-18UNEF-2B	.724 (18.39)	1.290 (32.77)	2.100 (53.34)	2.850 (72.39)	1.344 (34.14)	1-1/8-18UNEF-2B
20	.724 (18.39)	2.125 (53.98)	1.469 (37.31)	1-1/4-18UNEF-2B	.724 (18.39)	1.540 (39.12)	2.100 (53.34)	2.850 (72.39)	1.469 (37.31)	1-1/4-18UNEF-2B
22	.724 (18.39)	2.125 (53.98)	1.594 (40.49)	1-3/8-18UNEF-2B	.724 (18.39)	1.540 (39.12)	2.100 (53.34)	2.850 (72.39)	1.594 (40.49)	1-3/8-18UNEF-2B
24	.724 (18.39)	2.125 (53.98)	1.719 (43.66)	1-1/2-18UNEF-2B	.724 (18.39)	1.790 (45.47)	2.281 (57.94)	2.985 (75.82)	1.719 (43.66)	1-1/2-18UNEF-2B
28	.724 (18.39)	2.125 (53.98)	1.969 (50.01)	1-3/4-18UNEF-2B	.724 (18.39)	2.040 (51.82)	2.485 (63.12)	2.985 (75.82)	1.969 (50.01)	1-3/4-18UNEF-2B
32	.724 (18.39)	2.180 (55.37)	1.219 (30.96)	2-18UNS-2B	.724 (18.39)	2.290 (58.17)	2.485 (63.12)	2.985 (75.82)	1.219 (30.96)	2-18UNS-2B
36	.724 (18.39)	2.180 (55.37)	2.469 (62.71)	2-1/4-16UN-2B	.724 (18.39)	2.540 (64.52)	2.485 (63.12)	2.985 (75.82)	2.469 (62.71)	2-1/4-16UN-2B
40	.724 (18.39)	2.180 (55.37)	2.723 (69.16)	2-1/2-16UN-2B						

Performance Specifications - Page 168

Contact, Sealing Plugs, Assembly Tools - Page

187

Contact Arrangements - Page 171-174

Components

	MS3106R CA3106R Straight Plug	MS3106F CA06R Straight Plug	MS3106E* CA3106E Straight Plug	MS3108E CA3108E 90° Angle Plug	MS3108R CA3108R 90° Angle Plug
Endbell					
Ferrule					
Grommet					
Pin Contacts					
Insulator					
Coupling Nut					
Barrel					
O Ring					

Note: Class F is not applicable to MS3108 shell style.

* Class E inactive for new design. Use Class F or R.

How to Order

TBF and BFR pressurized bulkhead receptacles mate with standard MS type plugs (3106,3107 and 3108) if contact arrangements correspond. Both the BFR and TBF have resilient insulators. The TBF (thru-bulkhead fitting) version has a double-faced construction allowing mating from both ends. An O ring is supplied as standard on both the BFR and the TBF. Contacts are silver plated copper or brass alloy. Shells are aluminum alloy.

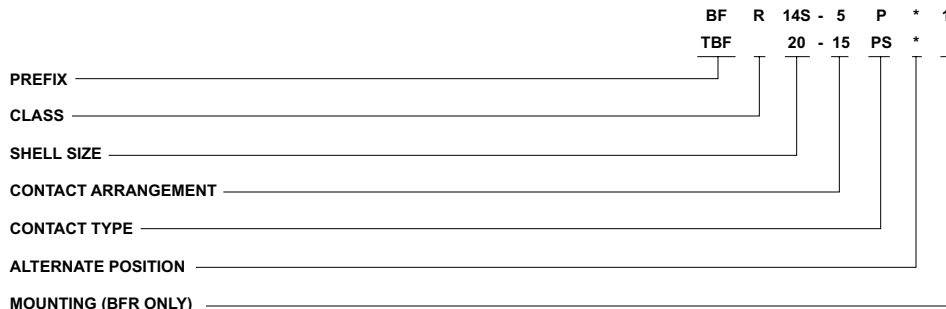

- PREFIX**
BF - Bulkhead Fittings
TBF - Thru bulkhead fittings
- CLASS**
* R - Resilient insulators
H - Hermetic; see page 327
*Letter designator "R" not required for TBF.
- SHELL SIZE**
Coupling thread diameter figured in sixteenths of an inch
- CONTACT ARRANGEMENTS**
See pages 171 - 174.
- CONTACT TYPE**
P for Pin; S for Socket; PS for Pin and Socket (TBF only)
- ALTERNATE POSITION**
(Consult factory for available alternate positions.)
- MOUNTING**
BFR only; see chart on page 183

Thru-Bulkhead Receptacle

TBF - Resilient Insulator

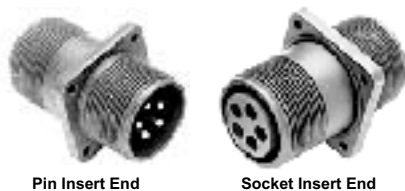

TBF thru-bulkhead fittings have pressurized resilient insulators. Special double-face pin and socket contact construction permits cable components to be wired and tested in the shop and then to be plugged into the mounted TBF plug to complete the installation. The TBF mates with 3106, 3107 and 3108 plugs.

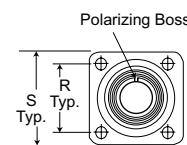
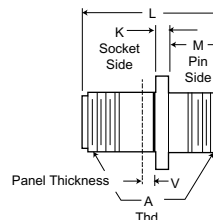
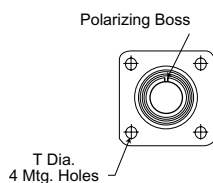

Shell Size	K Max.	L Max.	M		S	T		V Max.	A Thread
			+0.031 (0.79) -0.000 (0.00)	R ±.005 (0.13)		+0.010 (0.25) -0.005 (0.13)			
8S	.125 (3.18)	1.482 (37.64)	.562 (14.27)	.594 (15.09)	.875 (22.22)	.120 (3.05)	.325 (8.26)	1/2-28UNEF-2A	
10S	.125 (3.18)	1.482 (37.64)	.562 (14.27)	.179 (18.26)	1.000 (25.40)	.120 (3.05)	.325 (8.26)	5/8-24UNEF-2A	
10SL	.125 (3.18)	1.482 (37.64)	.562 (14.27)	.179 (18.26)	1.000 (25.40)	.120 (3.05)	.325 (8.26)	5/8-24UNEF-2A	
12S	.140 (3.56)	1.482 (37.64)	.562 (14.27)	.812 (20.62)	1.094 (27.79)	.120 (3.05)	.325 (8.26)	3/4-20UNEF-2A	
14S	.140 (3.56)	1.482 (37.64)	.562 (14.27)	.906 (23.01)	1.188 (30.18)	.120 (3.05)	.325 (8.26)	7/8-20UNEF-2A	
16S	.140 (3.56)	1.482 (37.64)	.562 (14.27)	.968 (24.59)	1.281 (32.54)	.120 (3.05)	.325 (8.26)	1-20UNEF-2A	
12	.146 (3.71)	2.030 (51.56)	.750 (19.05)	.812 (20.62)	1.094 (27.79)	.120 (3.05)	.445 (11.30)	3/4-20UNEF-2A	
14	.146 (3.71)	2.030 (51.56)	.750 (19.05)	.906 (23.01)	1.188 (30.18)	.120 (3.05)	.445 (11.30)	7/8-20UNEF-2A	
16	.146 (3.71)	2.030 (51.56)	.750 (19.05)	.968 (24.59)	1.281 (32.54)	.120 (3.05)	.445 (11.30)	1-20UNEF-2A	
18	.180 (4.57)	2.030 (51.56)	.750 (19.05)	1.062 (26.97)	1.375 (34.92)	.120 (3.05)	.445 (11.30)	1/18-18UNEF-2A	
20	.180 (4.57)	2.030 (51.56)	.750 (19.05)	1.156 (29.36)	1.500 (38.10)	.120 (3.05)	.445 (11.30)	1-1/4-18UNEF-2A	
22	.180 (4.57)	2.030 (51.56)	.750 (19.05)	1.250 (31.75)	1.625 (41.28)	.120 (3.05)	.445 (11.30)	1-3/8-18UNEF-2A	
24	.203 (5.16)	2.030 (51.56)	.812 (20.62)	1.375 (34.92)	1.750 (44.45)	.147 (3.73)	.383 (9.73)	1-1/2-18UNEF-2A	
28	.203 (5.16)	2.030 (51.56)	.812 (20.62)	1.562 (39.67)	2.000 (50.80)	.147 (3.73)	.383 (9.73)	1-3/4-18UNEF-2A	
32	.203 (5.16)	2.030 (51.56)	.875 (22.22)	1.750 (44.45)	2.250 (57.15)	.173 (4.39)	.320 (8.13)	2-18UNEF-2A	
36	.203 (5.16)	2.030 (51.56)	.812 (20.62)	1.938 (49.23)	2.500 (63.50)	.173 (4.39)	.383 (9.73)	2-1/4-16UNEF-2A	
40	.203 (5.16)	2.030 (51.56)	.875 (22.22)	2.188 (55.58)	2.750 (69.85)	.173 (4.39)	.383 (9.73)		

Pressurized Bulkhead Receptacle

BFR

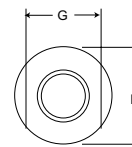
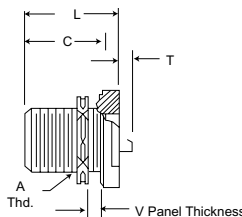
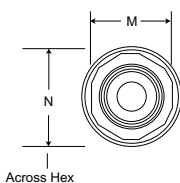

Standard Position
Pin is 3/32" Dia.

BFR pressurized bulkhead receptacles withstand the air leakage requirement of MIL-C-5015 not to exceed 1 cu. in. of air per hour when subjected to a pressure differential of 30 psi at - 55°C. Insulators are resilient material bonded to aluminum shell. Both pin and socket assemblies are available. The BFR will mate with standard MS type 3106, 3107, 3108 plugs.

TYPE 1

- Shell** Standard
- Insulator** Polychloroprene
- Lock Nut** Hex with 6 wire holes
- O Ring** Neoprene
- Position Pin** Standard
- Mounting** Figure 1 or 2
- Part No. Example:** BFR14S-5P-1

Shell Size	C Max.	G Max.	H Max.	L Max.	M Max.	N Max.	T Max. Solder Pot Ext.					V Max.
							#16	#12	#8	#4	#0	
8S	.853 (21.67)	.895 (22.73)	1.077 (27.36)	1.087 (27.61)	.702 (17.83)	.820 (20.83)	.140 (3.56)	-	-	-	-	.250 (6.35)
10S	.853 (21.67)	1.015 (25.78)	1.203 (30.56)	1.087 (27.61)	.822 (20.88)	.960 (24.38)	.140 (3.56)	-	-	-	-	.250 (6.35)
10SL	.853 (21.67)	1.015 (25.78)	1.203 (30.56)	1.087 (27.61)	.822 (20.88)	.960 (24.38)	.140 (3.56)	-	-	-	-	.250 (6.35)
12S	.853 (21.67)	1.077 (27.36)	1.327 (33.71)	1.087 (27.61)	.955 (24.26)	1.110 (28.19)	.140 (3.56)	-	-	-	-	.250 (6.35)
14S	.853 (21.67)	1.203 (30.56)	1.453 (36.91)	1.087 (27.61)	1.072 (27.23)	1.250 (31.75)	.140 (3.56)	-	-	-	-	.375 (9.52)
16S	.853 (21.67)	1.327 (33.71)	1.577 (40.06)	1.087 (27.61)	1.265 (32.13)	1.460 (37.08)	.140 (3.56)	-	-	-	-	.375 (9.52)
12	1.244 (31.60)	1.077 (27.36)	1.327 (33.71)	1.525 (38.74)	.955 (24.26)	1.110 (28.19)	.062 (1.57)	.062 (1.57)	-	-	-	.375 (9.52)
14	1.244 (31.60)	1.203 (30.56)	1.453 (36.91)	1.525 (38.74)	1.072 (27.23)	1.250 (31.75)	.062 (1.57)	.062 (1.57)	.125 (3.18)	-	-	.375 (9.52)
16	1.244 (31.60)	1.327 (33.71)	1.577 (40.06)	1.525 (38.74)	1.265 (32.13)	1.460 (37.08)	.062 (1.57)	.062 (1.57)	.125 (3.18)	.125 (3.18)	-	.375 (9.52)
18	1.244 (31.60)	1.453 (36.91)	1.703 (43.26)	1.525 (38.74)	1.395 (35.43)	1.610 (40.89)	.062 (1.57)	.062 (1.57)	.125 (3.18)	.125 (3.18)	-	.375 (9.52)
20	1.244 (31.60)	1.577 (40.06)	1.827 (46.41)	1.525 (38.74)	1.515 (38.48)	1.750 (44.45)	.062 (1.57)	.062 (1.57)	.125 (3.18)	.125 (3.18)	.359 (9.12)	.375 (9.52)
22	1.244 (31.60)	1.577 (40.06)	1.953 (49.61)	1.525 (38.74)	1.635 (41.53)	1.900 (48.26)	.062 (1.57)	.062 (1.57)	.125 (3.18)	.125 (3.18)	.359 (9.12)	.375 (9.52)
24	1.244 (31.60)	1.827 (46.41)	2.077 (52.76)	1.525 (38.74)	1.765 (44.83)	2.030 (51.56)	.062 (1.57)	.062 (1.57)	.125 (3.18)	.125 (3.18)	.359 (9.12)	.375 (9.52)
28	1.244 (31.60)	1.953 (49.61)	2.327 (59.11)	1.525 (38.74)	2.015 (51.18)	2.330 (59.18)	.062 (1.57)	.062 (1.57)	.125 (3.18)	.125 (3.18)	.359 (9.12)	.375 (9.52)
32	1.244 (31.60)	2.203 (55.96)	2.577 (65.46)	1.525 (38.74)	2.205 (56.01)	2.550 (64.77)	.062 (1.57)	.062 (1.57)	.125 (3.18)	.125 (3.18)	.359 (9.12)	.375 (9.52)
36	1.244 (31.60)	2.577 (65.46)	2.827 (71.81)	1.525 (38.74)	2.455 (62.36)	2.840 (72.14)	.062 (1.57)	.062 (1.57)	.125 (3.18)	.125 (3.18)	.359 (9.12)	.312 (7.92)

Shell Size	A Thread
8S	1/2-28UNEF-2A
10S	5/8-24UNEF-2A
10SL	5/8-24UNEF-2A
12S	3/4-20UNEF-2A
14S	7/8-20UNEF-2A
16S	1-20UNEF-2A
12	3/4-20UNEF-2A
14	7/8-20UNEF-2A

Shell Size	A Thread
16	1-20UNEF-2A
18	1-1/8-18UNEF-2A
20	1-1/4-18UNEF-2A
22	1-3/8-18UNEF-2A
24	1-1/2-18UNEF-2A
28	1-3/4-18UNEF-2A
32	2-18UNEF-2A
36	2-1/4-16UNEF-2A

Performance Specifications - Page 168

Contacts, Sealing Plugs, Assembly Tool - Page 187

Contact Arrangements - Page 171-174

Mounting Dimensions

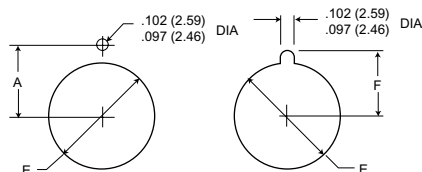

Shell Size	A	E	F
	±.005 (0.13)	+0.015 (0.38) -0.000 (0.00)	±.005 (0.13)
8S	.323 (8.20)	.500 (12.70)	.373 (9.47)
10S, 10SL	.385 (9.78)	.625 (15.88)	.435 (11.05)
12S, 12	.448 (11.38)	.750 (19.05)	.498 (12.65)
14S, 14	.510 (12.95)	.875 (22.22)	.560 (14.22)
16S, 16	.573 (14.55)	1.000 (25.40)	.623 (15.82)
18	.635 (16.13)	1.125 (28.58)	.685 (17.40)

Shell Size	A	E	F
	±.005 (0.13)	+0.015 (0.38) -0.000 (0.00)	±.005 (0.13)
20	.698 (17.73)	1.250 (31.75)	.748 (19.00)
22	.760 (19.30)	1.375 (34.92)	.810 (20.57)
24	.823 (20.90)	1.500 (38.10)	.873 (22.17)
28	.948 (24.08)	1.750 (44.45)	.998 (25.35)
32	1.073 (27.25)	2.000 (50.80)	1.123 (28.52)
36	1.198 (30.43)	2.250 (57.15)	1.248 (31.70)

Pressurized Bulkhead Receptacle

MS25042



CA17530
CA19741

For 06 and 08 Style Plugs

These externally threaded metal dust caps are used to protect the MS3106 and MS3108 plugs. Material is aluminum alloy. They are furnished with sash chain or less sash chain.

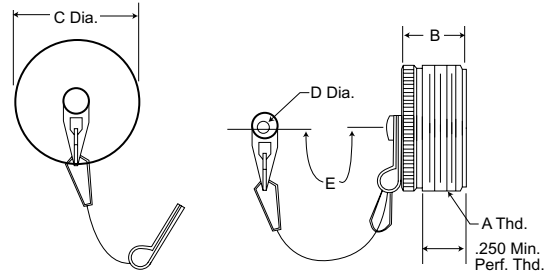

Part Number

Black Anodized Finish With Sash Chain		Olive Drab Chromate Over Cadmium Finish With Sash Chain		Olive Drab Chromate Over Cadmium Finish, Without Sash Chain		Fits Shell Size	B Max.	C Dia. Max.	E Max.	D Dia. Max.	A Thread
MS	ITT Cannon	Superseded MS Number (Ref)	May Still be Purchased by ITTC Part Number	Superseded MS Number (Ref)	May Still be Purchased by ITTC Part Number						
MS25042-8DA	CA17530-8000	MS25042-8D	CA17530-5100	MS25042-8D	CA19741-8	8S	.656 (16.66)	.562 (14.27)	4.500 (114.30)	.166 (4.22)	1/2-28UNEF-2A
MS25042-10DA	CA17530-8001	MS25042-10D	CA17530-5101	MS25042-10D	CA19741-10	10S, 10SL	.656 (16.66)	.687 (17.45)	4.500 (114.30)	.166 (4.22)	5/8-24UNEF-2A
MS25042-12DA	CA17530-8002	MS25042-12D	CA17530-5102	MS25042-12D	CA19741-12	12, 12S	.844 (21.44)	.812 (20.62)	5.000 (127.00)	.166 (4.22)	3/4-20UNEF-2A
MS25042-14DA	CA17530-8003	MS25042-14D	CA17530-5103	MS25042-14D	CA19741-14	14, 14S	.844 (21.44)	.937 (23.80)	5.000 (127.00)	.166 (4.22)	7/8-20UNEF-2A
MS25042-16DA	CA17530-8004	MS25042-16D	CA17530-5104	MS25042-16D	CA19741-16	16, 16S	.844 (21.44)	1.062 (26.97)	5.000 (127.00)	.166 (4.22)	1-20UNEF-2A
MS25042-18DA	CA17530-8005	MS25042-18D	CA17530-5105	MS25042-18D	CA19741-18	18	.844 (21.44)	1.187 (30.15)	5.000 (127.00)	.166 (4.22)	1-1/8-18UNEF-2A
MS25042-20DA	CA17530-8006	MS25042-20D	CA17530-5106	MS25042-20D	CA19741-20	20	.844 (21.44)	1.312 (33.32)	5.500 (139.70)	.197 (5.00)	1-1/4-18UNEF-2A
MS25042-22DA	CA17530-8007	MS25042-22D	CA17530-5107	MS25042-22D	CA19741-22	22	.844 (21.44)	1.437 (36.50)	5.500 (139.70)	.197 (5.00)	1-3/8-18UNEF-2A
MS25042-24DA	CA17530-8008	MS25042-24D	CA17530-5108	MS25042-24D	CA19741-24	24	.844 (21.44)	1.562 (39.67)	6.000 (152.40)	.197 (5.00)	1-1/2-18UNEF-2A
MS25042-28DA	CA17530-8009	MS25042-28D	CA17530-5109	MS25042-28D	CA19741-28	28	.844 (21.44)	1.812 (46.02)	8.250 (209.55)	.197 (5.00)	1-3/4-18UNEF-2A
MS25042-32DA	CA17530-8010	MS25042-32D	CA17530-5110	MS25042-32D	CA19741-32	32	.844 (21.44)	2.062 (52.37)	8.250 (209.55)	.228 (5.79)	2-18UNEF-2A
MS25042-36DA	CA17530-8011	MS25042-36D	CA17530-5111	MS25042-36D	CA19741-36	36	.844 (21.44)	2.312 (58.72)	8.250 (209.55)	.228 (5.79)	2-1/4-16UN-2A
MS25042-40DA	CA17530-8012	MS25042-40D	CA17530-5112	MS25042-40D	CA19741-40	40	.844 (21.44)	2.562 (65.07)	8.250 (209.55)	.228 (5.79)	2-1/2-16UN-2A
MS25042-44DA	CA17530-8013	MS25042-44D	CA17530-5113	MS25042-44D	CA19741-44	44	.844 (21.44)	2.812 (71.42)	8.250 (209.55)	.228 (5.79)	2-3/4-16UN-2A
MS25042-48DA	CA17530-8014	MS25042-48D	CA17530-5114	MS25042-48D	CA19741-48	48	.844 (21.44)	3.062 (77.77)	8.250 (209.55)	.228 (5.79)	3-16UN-2A

MS25043



CA2209
CA2322

For 00, 01 and 02 Style Receptacles

These internally threaded metal dust caps are used to protect MS3100, MS3101 and MS3102 receptacles. Material is aluminum alloy. They are furnished with sash chain or less sash chain.

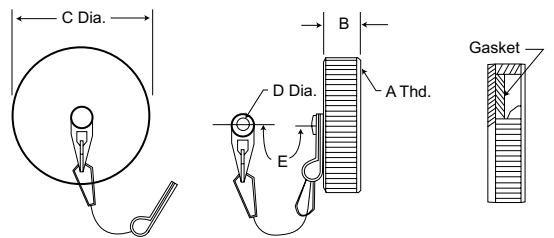

Part Number

Black Anodized Finish With Sash Chain		Olive Drab Chromate Over Cadmium Finish With Sash Chain		Olive Drab Chromate Over Cadmium Finish, Without Sash Chain		Fits Shell Size	B Max.	C Dia. Max.	E Max.	D Dia. Max.	A Thread
MS	ITT Cannon	Superseded MS Number (Ref)	May Still be Purchased by ITTC Part Number	Superseded MS Number (Ref)	May Still be Purchased by ITTC Part Number						
MS25043-8DA	CA2209-8000	MS25043-8D	CA2209-5100	MS25043-8D	CA2322-1	8S	4.69 (11.91)	.688 (17.48)	4.500 (114.30)	.150 (3.81)	1/2-28UNEF-2B
MS25043-10DA	CA2209-8001	MS25043-10D	CA2209-5101	MS25043-10D	CA2322-2	10S, 10SL	4.69 (11.91)	.815 (20.70)	4.500 (114.30)	.150 (3.81)	5/8-24UNEF-2B
MS25043-12DA	CA2209-8002	MS25043-12D	CA2209-5102	MS25043-12D	CA2322-3	12, 12S	4.69 (11.91)	1.000 (25.40)	5.000 (127.00)	.150 (3.81)	3/4-20UNEF-2B
MS25043-14DA	CA2209-8003	MS25043-14D	CA2209-5103	MS25043-14D	CA2322-4	14, 14S	4.69 (11.91)	1.125 (28.58)	5.000 (127.00)	.150 (3.81)	7/8-20UNEF-2B
MS25043-16DA	CA2209-8004	MS25043-16D	CA2209-5104	MS25043-16D	CA2322-5	16, 16S	4.69 (11.91)	1.188 (30.18)	5.000 (127.00)	.150 (3.81)	1-20UNEF-2B
MS25043-18DA	CA2209-8005	MS25043-18D	CA2209-5105	MS25043-18D	CA2322-6	18	4.69 (11.91)	1.344 (34.14)	5.000 (127.00)	.150 (3.81)	1-1/8-18UNEF-2B
MS25043-20DA	CA2209-8006	MS25043-20D	CA2209-5106	MS25043-20D	CA2322-7	20	4.69 (11.91)	1.469 (37.31)	5.500 (139.70)	.150 (3.81)	1-1/4-18UNEF-2B
MS25043-22DA	CA2209-8007	MS25043-22D	CA2209-5107	MS25043-22D	CA2322-8	22	4.69 (11.91)	1.594 (40.49)	5.500 (139.70)	.150 (3.81)	1-3/8-18UNEF-2B
MS25043-24DA	CA2209-8008	MS25043-24D	CA2209-5108	MS25043-24D	CA2322-9	24	4.69 (11.91)	1.719 (43.66)	6.000 (152.40)	.181 (4.60)	1-1/2-18UNEF-2B
MS25043-28DA	CA2209-8009	MS25043-28D	CA2209-5109	MS25043-28D	CA2322-10	28	.531 (13.49)	1.969 (50.01)	8.250 (209.55)	.181 (4.60)	1-3/4-18UNS-2B
MS25043-32DA	CA2209-8010	MS25043-32D	CA2209-5110	MS25043-32D	CA2322-11	32	.531 (13.49)	2.219 (56.36)	8.250 (209.55)	.197 (5.00)	2-18UNS-2B
MS25043-36DA	CA2209-8011	MS25043-36D	CA2209-5111	MS25043-36D	CA2322-12	36	.531 (13.49)	2.469 (62.71)	8.250 (209.55)	.197 (5.00)	2-1/4-16UN-2B
MS25043-40DA	CA2209-8012	MS25043-40D	CA2209-5112	MS25043-40D	CA2322-13	40	.531 (13.49)	2.719 (69.06)	8.250 (209.55)	.197 (5.00)	2-1/2-16UN-2B
MS25043-44DA	CA2209-8013	MS25043-44D	CA2209-5113	MS25043-44D	CA2322-14	44	.531 (13.49)	2.969 (75.41)	8.250 (209.55)	.197 (5.00)	2-3/4-16UN-2B
MS25043-48DA	CA2209-8014	MS25043-48D	CA2209-5114	MS25043-48D	CA2322-15	48	.531 (13.49)	3.188 (80.98)	8.250 (209.55)	.197 (5.00)	3-16UN-2B

Cable Clamp

M85049/41
With or Without Bushing



The M85049/41 cable clamp is made for plugs and receptacles that have an endbell with external conduit threads. The double clamping action provides a balanced, positive hold on the wires and greatly reduces moisture transmission. Provision is made for safety wiring. This clamp is supplied without bushing; to order bushing; add "with bushing" after part number.

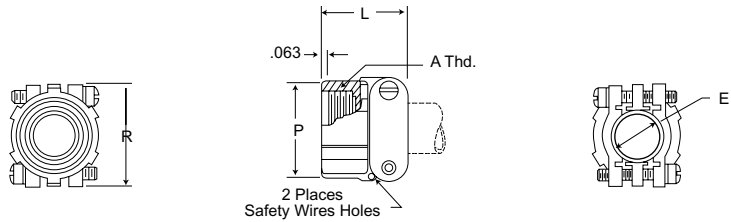

Part Number*	Superseded Part Number*	Fits Shell Size	Accommodates MS Bushings	E Min.	E Max.	L ± 0.31 (0.79)	P ± 0.31 (0.79)	R ± 0.31 (0.79)	A Thread
M85049/41-3A	MS3057-3A	8S-10S	MS3420-3	.102 (2.59)	.250 (6.35)	.812 (20.62)	.688 (17.48)	.812 (20.62)	1/2-28UNEF-2B
M85049/41-4A	MS3057-4A	10SL, 12S, 12	MS3420-4	.140 (3.56)	.312 (7.92)	.812 (20.62)	.812 (20.62)	.875 (22.22)	5/8-24UNEF-2B
M85049/41-6A	MS3057-6A	14S, 14	MS3420-6	.195 (4.95)	.438 (11.13)	.875 (22.22)	.969 (24.61)	1.062 (26.97)	3/4-20UNEF-2B
M85049/41-8A	MS3057-8A	16S, 16	MS3420-8	.255 (6.48)	.562 (14.27)	.938 (23.83)	1.094 (27.79)	1.156 (29.36)	7/8-20UNEF-2B
M85049/41-10A	MS3057-10A	18	MS3420-10	.285 (7.24)	.625 (15.88)	.938 (23.83)	1.188 (30.18)	1.250 (31.75)	1-20UNEF-2B
M85049/41-12A	MS3057-12A	20, 22	MS3420-12	.350 (8.89)	.750 (19.05)	.938 (23.83)	1.375 (34.92)	1.469 (37.31)	1-3/16-18UNEF-2B
M85049/41-16A	MS3057-16A	24, 28	MS3420-16, 12	.468 (11.89)	.938 (23.83)	1.031 (26.19)	1.656 (42.06)	1.688 (42.88)	1-7/16-18UNEF-2B
M85049/41-20A	MS3057-20A	32	MS3420-20, 16	.664 (16.87)	1.250 (31.75)	1.094 (27.79)	2.031 (51.59)	2.031 (51.59)	1-3/4-18UNS-2B
M85049/41-24A	MS3057-24A	36	MS3420-24, 20	.694 (17.63)	1.375 (34.92)	1.156 (29.36)	2.219 (56.36)	2.281 (57.94)	2-18UNS-2B
M85049/41-28A	MS3057-28A	40	MS3420-24, 20	.911 (23.14)	1.625 (41.28)	1.688 (42.88)	2.500 (63.50)	2.688 (68.28)	2-1/4-16UN-2B
M85049/41-32A	MS3057-32A	44	MS3420-32, 28, 24	-	1.875 (47.62)	1.750 (44.45)	2.781 (70.64)	2.938 (74.63)	2-1/2-16UN-2B
M85049/41-40A	MS3057-40A	48	MS3420-40, 32, 28	-	2.375 (60.32)	1.750 (44.45)	3.281 (83.34)	3.500 (88.90)	3-16UN-2B

*To order cable clamp with bushing, add "with bushing" after part number.

Telescoping Bushing

**MS3420/
MS39056(REF.)**

CA18220

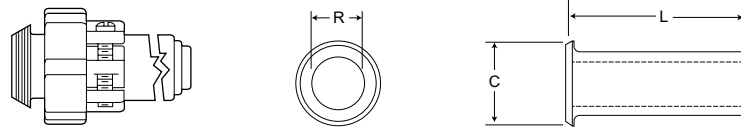

Telescoping bushing with M85049/41 cable clamp

Telescoping gland bushing (used with M85049/41 cable clamp) keep dirt, oil and moisture out of endbell. Taping or wrapping wires is eliminated since bushing protects wires going thru clamp. Combinations of bushings may be used to decrease cable entry diameter to improve sealing.

MS Part Number	Superseded MS Part Number	ITT Cannon Part Number	Fits Shell Size	C ± 0.16 (0.41)	L ± 0.31 (0.79)	R ± 0.16 (0.41)
MS3420-3	MS39056-1	CA18220-3	8S-10S	.379 (9.63)	2.875 (73.02)	1.30 (3.30)
MS3420-4	MS39056-2	CA18220-4	10SL, 12S, 12	.505 (12.83)	2.750 (69.85)	.200 (5.09)
MS3420-6	MS39056-3	CA18220-6	14S, 14	.619 (15.72)	2.625 (66.68)	.312 (7.92)
MS3420-8	MS39056-4	CA18220-8	16S, 16	.744 (18.90)	2.500 (63.50)	.437 (11.10)
MS3420-10	MS39056-5	CA18220-10	18	.869 (22.07)	2.375 (60.32)	.562 (14.27)
MS3420-12	MS39056-6	CA18220-12	20, 22	1.064 (27.03)	2.250 (57.15)	.625 (15.88)
MS3420-16	MS39056-7	CA18220-16	24, 28	1.314 (33.38)	2.125 (53.98)	.750 (19.05)
MS3420-20	MS39056-8	CA18220-20	32	1.596 (40.54)	2.000 (50.80)	.937 (23.80)
MS3420-24	MS39056-9	CA18220-24	36	1.847 (46.91)	1.875 (47.62)	1.250 (31.75)
MS3420-28	MS39056-10	CA18220-28	40	2.085 (52.96)	1.750 (44.45)	1.375 (34.92)
MS3420-32	MS39056-11	CA18220-32	44	2.335 (59.31)	1.625 (41.28)	1.624 (41.25)
MS3420-40	MS39056-12	CA18220-40	48	2.835 (72.01)	1.500 (38.10)	1.874 (47.60)

Plastic Protective Caps



025-XXXX-000

Protective dust caps are designed to cover the coupling and conduit ends of MS connectors where there is a possibility of foreign matter accumulating on the interior of the connector or of damage to the threaded parts. Material is red polyethylene. Plastic dust caps can be reused, but are not intended to replace the standard aluminum dust caps shown on preceding pages.

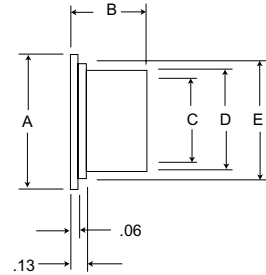

Part Number*	MS3100F,R		MS3102F,R		MS-F (only) Solder Pot End	MS3106/MS3108 F,R		Dimensions					
	Coupling End	Solder Pot End	Coupling End	Solder Pot End		Coupling End	Solder Pot End	A Max.	B Max.	C Max.	D Max.	E Max.	Wt. Lb.
025-0458-000				8S		8S		.673	.440	.430	.486	.583	.0012
025-0459-000	8S	8S, 10S	8S	8S, 10S	10S		8S, 10S	.734	.440	.490	.546	.644	.0014
025-0460-000	10S, 10SL	10SL, 12S, 12	10S, 10SL	10SL, 12S, 12		10SL, 12S, 12	10SL, 12S, 12	.848	.700	.600	.656	.758	.0022
025-0462-000	12S, 12	14S, 14	12S, 12	14S, 14			14S, 14	.973	.700	.730	.786	.883	.0028
025-0463-000	14S, 14	16S, 16	14S, 14	16S, 16			16S, 16	1.098	.700	.850	.908	1.008	.0033
025-0466-000				18	18			1.209	.700	.950	1.016	1.119	.0042
025-0467-000				20		20		1.396	.700	1.150	1.216	1.308	.0054
025-0468-000	20		20	22	22			1.500	.700	1.240	1.306	1.405	.0060
025-0469-000	22		22	24	24			1.625	.700	1.360	1.426	1.530	.0067
025-0470-000				28				1.870	.700	1.610	1.676	1.775	.0087
025-0471-000				32				2.120	.700	1.860	1.926	2.025	.0103
025-0472-000				36				2.370	.700	2.110	2.176	2.275	.0141
025-0473-000				40				2.501	.700	2.310	2.380	2.491	.0164
025-0474-000				44				2.872	.700	2.590	2.660	2.772	.0186
025-0475-000				48				3.122	.700	2.840	2.910	3.022	.0222
025-0477-000						10S, 10SL		.802	.491	.550	.616	.712	.0017
025-0478-000						12S, 12		.911	.571	.669	.725	.821	.0022
025-0479-000						14S, 14		1.036	.571	.794	.850	.946	.0027
025-0480-000						16S, 16		1.161	.571	.919	.975	1.071	.0033
025-0484-000						18		1.290	.576	1.028	1.094	1.195	.0044
025-0486-000						22		1.540	.576	1.278	1.344	1.445	.0058
025-0487-000						24		1.665	.576	1.403	1.469	1.570	.0066
025-0488-000						28		1.907	.576	1.645	1.711	1.812	.0084
025-0489-000						32		2.157	.576	1.895	1.961	2.062	.0102
025-0490-000						36		2.412	.576	2.140	2.216	2.317	.0132
025-0491-000						40		2.672	.576	2.390	2.466	2.572	.0163
025-0492-000						44		2.922	.576	2.640	2.716	2.822	.0186
025-0493-000						48		3.172	.576	2.890	2.966	3.072	.0213
025-0498-000	16S, 16	18	16S, 16	48			18	1.240	.700	.990	1.056	1.150	.0044
025-0499-000		20, 22		36		22	20, 22	1.427	.700	1.117	1.183	1.337	.0055
025-0500-000		24, 28		40			24, 28	1.677	.700	1.420	1.486	1.587	.0072
025-0501-000	28	32	28	44			32	1.985	.700	1.730	1.796	1.895	.0095
025-0502-000	32	36	32	32			36	2.245	.700	1.980	2.046	2.155	.0114
025-0503-000	36	40	36	24, 28		40	40	2.495	.700	2.230	2.296	2.400	.0134
025-0504-000	40	44	40	20, 22		44	44	2.742	.700	2.480	2.546	2.652	.0186
025-0505-000	48		48	18		48	48	3.257	.700	2.980	3.046	3.157	.0233
025-0507-000	18		18		20			1.365	.700	1.110	1.176	1.275	.0050
025-0510-000	24		24					1.740	.700	1.490	1.556	1.650	.0077
025-0511-000	44	48	44					3.007	.700	2.730	2.796	2.907	.0220
025-0608-000					8S			.643	.440	.400	.456	.553	.0011
025-0609-000					10SL, 12S, 12			.829	.700	.580	.636	.739	.0021
025-0610-000					14S, 14			.954	.700	.710	.766	.864	.0028
025-0611-000					16S, 16			1.079	.700	.830	.886	.989	.0032
025-0612-000					28			1.839	.700	1.570	1.626	1.744	.0088
025-0613-000					32			2.089	.700	1.820	1.876	1.994	.0100
025-0614-000					36			2.376	.700	2.010	2.066	2.231	.0132

F80 Assembly Instructions

ITT Cannon provides a complete line of crimp insertion and extraction tooling to be used with CA-F80 contacts as follows.

Contact Size	Hand Crimp Tool*	Locator	Power Crimp Tool**	Crimp Head	Locator	Gauge
16	M-22520/1-01	TH-70-1	CBT-530			
12	M-22520/1-01	TP567	CBT-600/600B	CCH-12-7	CCHP-12-2	-
8	-	-	CBT-600/600B	CCH-8-1	CCHP-8-1	CCH-8-1
4	-	-	CBT-600/600B	CCH-4-1	CCHP-4-1	CCH-4-1
0	-	-	CBT-600B	CCH-0-1	CCHP-0-9	CCH-0

*The M-22520/1-01 is the MIL standard crimp tool for #12 thru #20 contacts and when used with crimp #12, 16 and 20 contacts for the CA-F80.

**The CBT-600 is recommended for crimping of #4 thru #12 contacts. The CBT-600B for #0 thru #8. The appropriate locators and crimp heads are available as shown above



CBT-600



CBT-520/530

Crimp Tool



Crimping Contacts

1. Check the crimp tool to be sure that the proper crimp head locator is used
2. Cycle the tool to be sure the indentors are open.
3. Place the contact, mating end first, into the tool.
4. Insert the stripped wire into the hollow end of the contact. Be sure the wire is inserted as far as it will go.
5. Close the tool completely to crimp. Unless the tool is closed completely, the tool will not release the contact.
6. Remove the crimped contact from the tool. Check the inspection hole to verify that the wire is fully inserted.

Insetion/Extraction Tools



Insetion and extraction tools used for these connectors are available for contact sizes 16 thru 0 as shown.

Contact Size	Insertion Tools	Extraction Tools	Handle Color
16	CIT-16 (038895-0000)	CET-16-4 (038888-0004)	Blue
12	CIT-12 (038896-0000)	CET12-2 (038890-0002)	Yellow
8	CIT-8	CET-8	Red
4	CIT-4	CET-4	Blue
0	CIT-0	CET-0	Yellow

Insertion of Contacts

1. Before inserting the contacts, remove the endbell, grommets, and ferrule from the receptacle. Remove the endbell, grommet, ferrule, and coupling nut from the plug. Slide the hardware over the wire bundle in the proper order for reassembly after all the contacts are inserted.
2. To assist insertion of contacts, lubricate insert cavities with isopropyl alcohol. Alcohol will evaporate and will not leave a conductive film. **Caution: Never use any lubricant other than isopropyl alcohol.** Hold the plug or receptacle body firmly and insert the wired contacts as far as possible by hand. Starting at one side of the insulator, work progressively from contact to contact across the layout. When inserting socket contacts, be sure to provide fixture space below the front face to permit length of guide pins for #16 and #12 contacts to clear insulator face.
3. Place the correct insertion tool on the contact so that the wire runs along the groove in the tool. (Tool tip will butt against the shoulder.)
4. Beginning with a cavity on the outer edge of the plug, apply a slow, even pressure perpendicular to the insulator face until the contact snaps into position. If contacts are not inserted all the way prior to removing insertion tool, do not try to reinsert the insertion tool. Instead, using the extraction tool, push the contact back to position it was in when the insertion tool was originally placed over the contact for push-in; other wise the inside of contact cavity may be damaged by reinserting the insertion tool.
5. Inspect the front end of the insulator to assure that the contacts are inserted to the proper depth.

Completion

After all the cavities have been filled, slide the hardware back into position on the barrel. Tighten the endbell until the ferrule and endbell are flush. Compression of the grommet in this manner results in maximum sealing characteristics of the plug.

Extraction of Contacts

1. Select the appropriate tool. (Tool tips are reversible for either pin or socket.) Place the extraction tool over the pin or into the socket.
2. Apply a slow, even pressure to push the contact out of the rear of the insulator.

Recommended Wire Stripping

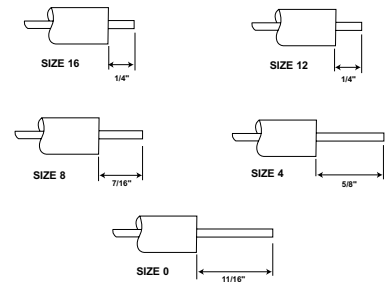

Contacts

Contact Part Numbers		
F80		
Contact Size	Pin	Socket
16S	330-0345-016	031-0554-161
16	330-0351-016	031-0560-161
12	330-0351-012	031-0560-121
8	330-0351-008	031-0560-081
4	330-0351-004	031-0560-041
0	330-0351-000	031-0560-001

Guide Pins

Guide pins are used to assist insertion of socket contact Sizes #16 and #12. Larger sizes do not require guide pins.

Contact	Guide Pin
#16	226-1017-000
#12	226-1018-000

Wire Hole Fillers

Size	ITT Cannon Part Numbe	MS Number
16	225-0017-000	MS25251-16
12	225-0018-000	MS25251-12
8	225-0019-000	MS25251-8

Standard Circular High Environmental Connectors - These connectors are available for many applications, from commercial/industrial and mass transportation systems to the most stringent high reliability military and space requirements.

The MS/CV345* connector manufactured by ITT Cannon to MIL-C-5015 (Navy) is a threaded coupling, removable rear release crimp contact type. Fully intermateable with existing MIL-C-5015 and threaded MIL-C-83723 Series II (USAF) type connectors, they provide for minimum effort and high economy upgrades for existing applications. In addition, they offer simplified design for new and interphase equipment.

MS/CV connectors covered under MIL-C-5015 (Navy) utilize fluid resistant elastomers to provide maximum protection against degrading fuels, oils, coolants and cleansers.

Temperature withstanding capabilities range from -55°C to +200°C depending upon the class. The use of electroless nickel and cadmium plating for hardware finishes gives the connectors maximum protection from the above factors. High quality manufacturing processes and materials combine to insure the optimum performance and reliability under and extreme range of environmental conditions

The MS/CV connector manufactured by ITT Cannon is available in five shell styles and 72 contact arrangements accommodating from 1 to 52 contact (sizes 0, 4, 8, 12 and 16.)

This connectors series is manufactured to accommodate the followings backshells: M85049/43 (MS3415), M85049/31 or /60 (MS3416), M85049/52 (MS3417). M85049/51 (MS3418) and M85049/26 (MS3419).

Shell polarization is effected by a single keyway and key, and stanared MS polarization positions are available to prevent mismatching.

* For information regarding MIL-C-83723, Series II (CVA), connectors, please call ITT Canon, 714-557-4700.

Features

Universal Insertion/Extraction Tool Style - A Single, expendable plastic tool is used for insertion and extraction of both pins and sockets. Tool never touches engaging ends of contacts, cannot damage insert.

Simple, Strong Contact Design - One basic configuration eliminates undercuts, maximizes bend resistance for positive contact mating.

Interfacial Pin Insert Seal - Universal interconnect permits design of raised moisture barriers around each pin which mate into lead-in chamfers of hard face socket insert for individual contact sealing. Interfacial seal is never touched by service tools.

Superior Contact Stability - "Closed-down" design of each contact cavity in the insulator support each contact, minimizes contact splaying.

Closed Entry Socket Insert - Hard dielectric socket face of mating connector has lead-in chamfers for positive alignment of pins and sockets.

Simplified Assembly Operations - One standard procedure for assembling connectors and contacts.. standard MS crimp tools...all servicing of contacts accomplished from the rear of the connector.

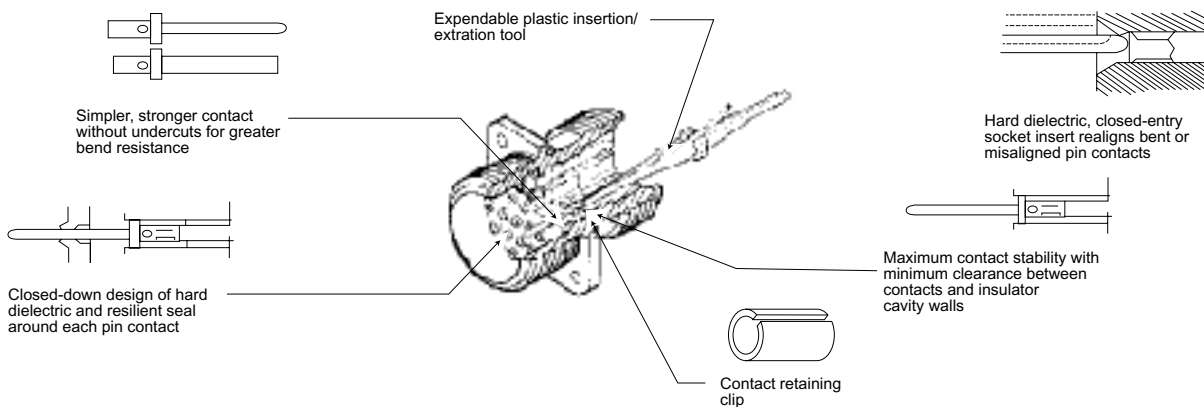

How to Order

PREFIX

- MS - Complies with MIL-C-5015
- CV - ITT Cannon Prefix

SHELL STYLES

- MS3450 - Wall Mounting Receptacle
- MS3451 - Cable Connecting Receptacle
- MS3452 - Box Mounting Receptacle
- MS3456 - Cable Connecting Plug
- MS3459 - Cable Connecting Plug with Self-Locking Coupling Nut
- CV3450 - Wall Mounting Receptacle
- CV3451 - Cable Connecting Receptacle
- CV3452 - Box Mounting Receptacle
- CV3456 - Cable Connecting Plug
- CV3459 - Cable Connecting Plug with Self-Locking Coupling Nut

CONNECTOR CLASSES

- Class KT, KS - Firewall
- Class L, LS - High Temperature, Fluid Resistant
- Class W - General Purpose

SHELL SIZE

See pages 190-192.

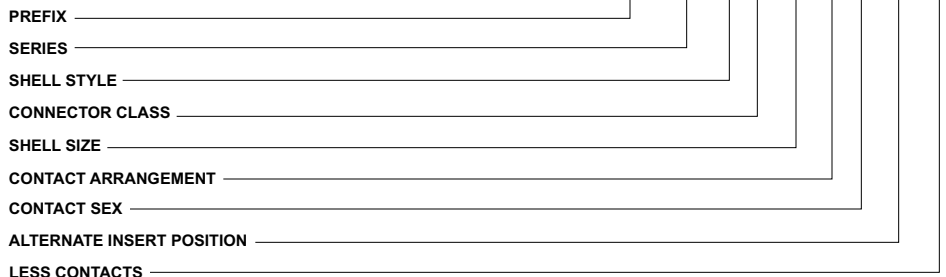

CONTACT ARRANGEMENT
See page 193 and 194.

CONTACT SEX

- P - Pin
- S - Socket
- *A - Less Pin Contact
- *B - Less Socket Contact

* Used only when other than power contacts are to be installed (i.e., Shielded, thermocouple, etc.)

ALTERNATE INSERT POSITION
W, X, Y and Z (Omit for "Normal")

LESS CONTACTS

Use "FO" when connectors are ordered less contacts, sealing plug and insertion/extraction tool ("FO" is not stamped on connector).

Performance Specifications

Class	Temp. °C	Moisture, Fluid and Fuel Resistant	Shell Material	Finish
W	+175 -55	Yes	Aluminum per QQ-A-225 or QQ-A-591	Olive drab over cad plate
L & M83723/**	+200 -55	Yes		Electroless nickel
KT	+175 -55	Yes	Steel per QQ-S-637	Olive drab over cad plate
KS LS	+200 -55	Yes	Stainless Steel	Passivate

NOTE: Resistant to hydraulic fluid per MIL-H-5606 or Skydrol (LD), lubricating oils per MIL-L-7808 and MIL-L-23699, cleaners CeeBee A694 or Aerosafe 2300, jet engine fuel per MIL-J-5624 Grade JP-5, Ethylene Glycol, and Collanol 25.

Contacts (Crimp Removable Rear Release)

Material - Copper Alloy
 Finish - Size 16 - Gold over Nickel
 Size 12, 8, 4, 0 and 0-silver plated

Wire Range Accommodations

Contact Size	Wire Size	O.D of Finished Wire (Inch) ¹	
		Minimum	Maximum
16-16	20, 18, 16	.053 (1.35)	.103 (2.62)
12-12	14, 12	.085 (2.16)	.158 (4.01)
8-8	10, 8	.132 (3.35)	.255 (6.48)
4-4	6, 4	.237 (6.02)	.370 (9.40)
0-0	2, 0	.360 (9.14)	.550 (13.97)

¹Wire Reference - MIL-W-16878, MIL-W-22759, MIL-W-81381, MIL-C-915, MIL-C-24145 and MIL-C-2194.

²MS3348 Bushing required in crimp barrel to accommodate 10, 6 and 2 wire sizes - they are ordered separately, consult factory.

Test Data

High Potential Test Voltage

MS/CV connectors show no evidence of breakdown when the test voltage given below is applied between the two closest contacts and between, the shell and the contacts closest to the shell for a period of one minute.

Service Rating	Test Voltage (rms) 60cps	Suggested Operating Voltage*	
		DC	AC (rms)
Inst.	1000	250	200
A	2000	700	500
D	2800	1250	900
E	3500	1750	1250
B	4500	2450	1750
C	7000	4200	3000

* As indicated in previous MS Specification and to be used by the designer only as a guide.

Test Current

Test current ratings of contacts and allowable voltage drop under test conditions when assembled as in service are shown below. Maximum total current to be carried per connector is the same as that allowable in wire bundles as specified in MIL-W-5088.

Current Rating with Silver Plated Wire (MIL-C-5015 test method)

Contact Size	Test Current (amps)	Potential Drop (millivolts)
16	13	49
12	23	42
8	46	26
4	80	23
0	150	21

MS Alternate Positions

All views are looking into front of pin insert or rear of socket insert.

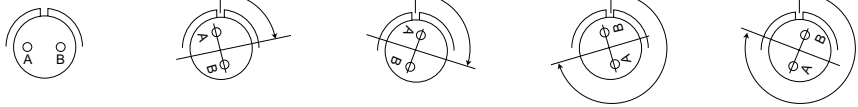

Shell Size	No. of Contacts	Contact Arr.	Degrees			
			W	X	Y	Z
8S	1 #16	8S-1	-	-	-	-
10S	1 #16	10S-2	-	-	-	-
10SL	2 #16	10SL-4	-	-	-	-
12	1 #12	12-5	-	-	-	-
12S	2 #16	12S3	70	145	215	290
14S	2 #16	14S-9	70	145	215	290
	3 #16	14S-7	90	180	270	-
	4 #16	14S-2	-	120	240	-
	5 #16	14S-5	-	110	-	-
16S	6 #16	14S-6	-	-	-	-
	2 #16	16S-4	35	110	250	325
	5 #16	16S-8	-	170	265	-
	7 #16	16S-1	80	-	-	280
16	2 #12	16-11	35	110	250	325
	3 #12	16-10	90	180	270	-
	2 #16,2 #12	16-9	35	110	250	325
	2 #16,1 #8	16-7	80	110	250	280
	4 #16	16-4	35	110	250	325
18	4 #12	18-10	-	120	240	-
	3 #16	18-22	70	145	215	290
	5 #12	18-11	-	170	265	-
	6 #12	18-12	80	-	-	280
	5 #16,2 #12	18-9	80	110	250	280
	7 #16,1 #12	18-8	70	-	-	290
	10 #16	18-1	70	145	215	290

Shell Size	No. of Contacts	Contact Arr.	Degrees			
			W	X	Y	Z
20	1 #0	20-2	-	-	-	-
	4 #12	20-4	45	110	250	-
	8 #16	20-7	80	110	250	280
	7 #16,2 #12	20-16	80	110	250	280
	14 #16	20-27	35	110	250	325
	17 #16	20-29	80	-	-	280
	3 #12,2 #8	20-14	80	110	250	280
	6 #16,3 #12	20-18	35	110	250	325
	7 #12	20-15	80	-	-	280
	22	3 #8	22-2	70	145	215
4 #8		22-22	-	110	250	-
1 #16,4 #12		22-13	35	110	250	325
4 #16,2 #12		22-5	35	110	250	325
24	8 #16	22-18	80	110	250	280
	6 #16,3 #12	22-16	80	110	250	280
	14 #16	22-19	80	110	250	280
	19 #16	22-14	80	-	-	280
	9 #16,2 #12	24-20	80	110	250	280
	3 #16,1 #0	24-4	80	110	250	280
	4 #8	24-22	45	110	250	-
	7 #8	24-10	80	-	-	280
	6 #12,3 #8	24-11	35	110	250	325
	14 #16,2 #12	24-7	80	110	250	280
24 #16	24-28	80	110	250	280	

Shell Size	No. of Contacts	Contact Arr.	Degrees				
			W	X	Y	Z	
28	6 #16,6 #12	28-9	80	110	250	280	
	12 #16	28-18	70	145	215	290	
	12 #16,2 #12	28-2	35	110	250	325	
	15 #16	28-17	80	110	250	280	
	18 #16,4 #12	28-11	80	110	250	280	
	26 #16	28-12	90	180	270	-	
	35 #16	28-15	80	110	250	280	
	37 #16	28-21	80	110	250	280	
	32	4 #4	32-71	45	110	250	-
		12 #16,2 #4	32-9	80	110	250	280
10 #16,5 #12		32-12	80	110	250	280	
16 #16,3 #8		32-6	80	110	250	280	
36	2 #12,2 #4	-	-	-	-		
	18 #16,5 #12	32-13	80	110	250	280	
	28 #16,7 #12	32-7	80	125	235	280	
	40 #16,7 #12	36-7	80	110	250	280	
	46 #16	36-10	80	125	235	280	
	4 #0	36-5	-	120	240	-	
	4 #4,2 #0	36-6	35	110	250	325	
	3 #12,3 #0	36-3	70	145	215	290	
	46 #16,1 #12	36-8	80	110	250	280	
	52 #16	36-52	72	144	216	288	
40	24 #16,6 #12	40-1	65	130	235	300	

*20-29 is an auth. position but it is possible to cross mate to normal position.

Wall Mounting Receptacle

MS3450

CV3450

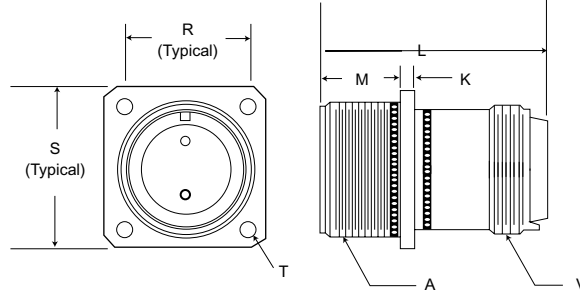

Cable Connecting Receptacle

MS3451
(Class L and W only)

CV3451

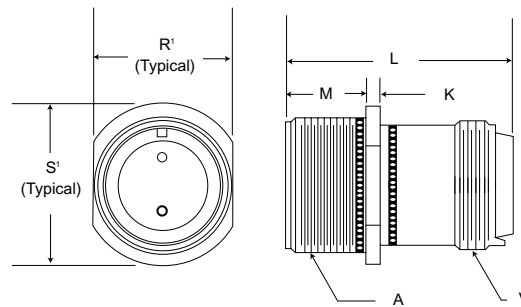

Shell Size	Contact #16,#12,#8,#4	Contact #0	K ±.015 (.38)	M +.031 (.79) -.000 (.00)	R ±.005 (.13)	R' Max.	S ±.031 (.87)	S' ±.031 (7.87)	T Dia. +.015/-.000 (+.038/-0.00)	
									Class L, W, LS	Class KT, KS
8S	1.750 (44.45)	--	.053 (2.11)	.562 (14.27)	.594 (15.09)	.504 (12.80)	.875 (22.22)	.729 (18.52)	.115 (2.92)	.145 (3.68)
10S	1.750 (44.45)	--	.053 (2.11)	.562 (14.27)	.562 (14.27)	.629 (15.98)	1.000 (25.40)	.854 (21.69)	.115 (2.92)	.145 (3.68)
10SL	1.750 (44.45)	--	.053 (2.11)	.562 (14.27)	.719 (18.26)	.629 (15.98)	1.00 (25.40)	.854 (21.69)	.115 (2.92)	.145 (3.68)
12S	1.750 (44.45)	--	.053 (2.11)	.562 (14.27)	.812 (20.62)	.754 (19.15)	1.094 (27.79)	.974 (24.74)	.115 (2.92)	.145 (3.68)
12	2.100 (53.34)	--	.053 (2.11)	.750 (19.05)	.812 (20.62)	.754 (19.15)	1.094 (27.79)	.974 (24.74)	.115 (2.92)	.145 (3.68)
14S	1.750 (44.45)	--	.053 (2.11)	.562 (14.27)	.906 (23.01)	.879 (22.33)	1.188 (30.18)	1.099 (27.91)	.115 (2.92)	.145 (3.68)
14	2.100 (53.34)	--	.053 (2.11)	.750 (19.05)	.906 (23.01)	.879 (22.33)	1.188 (20.18)	1.099 (27.91)	.115 (2.92)	.145 (3.68)
16S	1.750 (44.45)	--	.053 (2.11)	.562 (14.27)	.969 (24.61)	1.005 (25.53)	1.281 (32.54)	1.224 (31.09)	.115 (2.92)	.145 (3.68)
16	2.100 (53.34)	--	.053 (2.11)	.750 (19.05)	.969 (24.61)	1.005 (25.53)	1.281 (32.54)	1.224 (31.09)	.115 (2.92)	.145 (3.68)
18	2.100 (53.34)	--	.125 (3.18)	.750 (19.05)	1.062 (26.97)	1.131 (28.73)	1.375 (34.92)	1.349 (34.26)	.115 (2.92)	.172 (4.37)
20	2.100 (53.34)	2.250 (57.15)	.125 (3.18)	.750 (19.05)	1.156 (29.36)	1.256 (31.90)	1.500 (38.10)	1.474 (37.44)	.115 (2.92)	.172 (4.37)
22	2.100 (53.34)	2.250 (57.15)	.125 (3.18)	.750 (19.05)	1.250 (31.75)	1.381 (35.08)	1.625 (41.28)	1.599 (40.61)	.115 (2.92)	.172 (4.37)
24	2.100 (53.34)	2.250 (57.15)	.125 (3.18)	.812 (20.62)	1.375 (34.92)	1.506 (38.25)	1.750 (44.45)	1.715 (43.56)	.142 (3.61)	.172 (4.37)
28	2.100 (53.34)	2.250 (57.15)	.125 (3.18)	.812 (20.62)	1.562 (39.67)	1.756 (44.60)	2.000 (50.80)	1.974 (50.14)	.142 (3.61)	.172 (4.37)
32	2.100 (53.34)	2.250 (57.15)	.125 (3.18)	.875 (22.22)	1.750 (44.45)	2.007 (50.98)	2.250 (57.18)	2.224 (56.49)	.168 (4.27)	.204 (5.18)
36	2.100 (53.34)	2.250 (57.15)	.125 (3.18)	.875 (22.22)	1.938 (49.23)	2.257 (57.33)	2.500 (63.50)	2.474 (62.84)	.168 (4.27)	.204 (5.18)
40	2.100 (53.34)	2.250 (57.15)	.125 (3.18)	.875 (22.22)	2.188 (55.58)	2.511 (63.78)	2.750 (69.85)	2.724 (69.19)	.168 (4.27)	.204 (5.18)
44	2.100 (53.34)	2.250 (57.15)	.125 (3.18)	.875 (22.22)	2.375 (60.32)	2.761 (70.13)	3.000 (76.20)	2.974 (75.54)	.168 (4.27)	.204 (5.18)
48	2.100 (53.34)	2.250 (57.15)	.125 (3.18)	.875 (22.22)	2.625 (66.68)	3.011 (76.48)	3.250 (82.55)	3.224 (81.89)	.168 (4.27)	.204 (5.18)

Size Shell	A Thread Class 2A	V Thread Class 2A
8S	1/2-28UNEF	1/2-20UNEF
10S	5/8-24UNEF	5/8-24UNEF
10SL	5/8-24UNEF	5/8-24UNEF
12S	3/4-20UNEF	3/4-20UNEF
12	3/4-20UNEF	3/4-20UNEF
14S	7/8-20UNEF	7/8-20UNEF
14	7/8-20UNEF	7/8-20UNEF
16S	1-20UNEF	1-20UNEF
16	1-20UNEF	1-20UNEF

Size Shell	A Thread Class 2A	V Thread Class 2A
18	1-1/8-18UNEF	1-1/16-18UNEF
20	1-1/4-18UNEF	1-3/16-18UNEF
22	1-3/8-18UNEF	1-5/16-18UNEF
24	1-1/2-18UNEF	1-7/16-18UNEF
28	1-3/4-18UNS	1-3/4-18UNS
32	2-18UNS	2-18UNS
36	2-1/4-16UN	2-1/4-16UN
40	2-1/2-16UN	2-1/2-16UN
44	2-3/4-16UN	2-3/4-16UN
48	3-16UN	3-16UN

Performance Specifications - Page 189

Contacts, Sealing Plugs, Assembly Tools - Page 195

Contact Arrangements - Page 193-194



Cannon

Dimensions are shown in inches (millimeters).
Dimensions subject to change.

www.ittcannon.com

Box Mounting Receptacle

MS3452
Class L and W only

CV3452

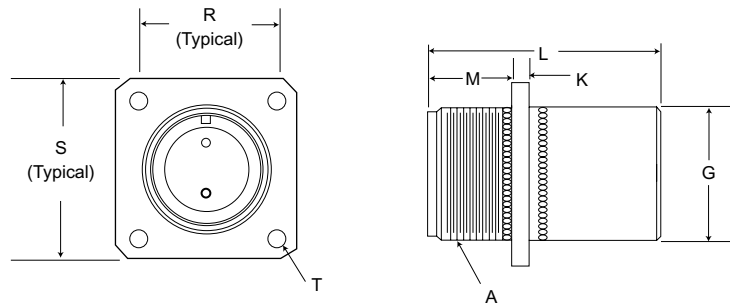

Shell Size	G Dia. ±.016 (0.41)	K ±.015 (0.38)	L Max.		M +.031/ (.79/ -.000 -.00)	R ±.005 (.13)	S ±.031 (0.79)	T Dia. +.015/-.000 (+0.38/-0.00)	A Thread Class 2A
			Contact #16 & #12	Contact #8, #4, & #0				Class L, W	
8S	.500 (12.70)	.083 (2.11)	.1662 (42.21)	--	.562 (14.27)	.594 (15.09)	.875 (22.22)	.115 (2.92)	1/2-28UNEF
10S	.625 (15.88)	.083 (2.11)	.1662 (42.21)	--	.562 (14.27)	.719 (18.26)	1.000 (25.40)	.115 (2.92)	5/8-24UNEF
10SL	.625 (15.88)	.083 (2.11)	.1662 (42.21)	--	.562 (14.27)	.719 (18.26)	1.00 (25.40)	.115 (2.92)	5/8-24UNEF
12S	.750 (19.05)	.083 (2.11)	.1662 (42.21)	--	.562 (14.27)	.812 (20.62)	1.094 (27.79)	.115 (2.92)	3/4-20UNEF
12	.750 (19.05)	.083 (2.11)	.1662 (42.21)	--	.750 (19.05)	.812 (20.62)	1.094 (27.79)	.115 (2.92)	3/4-20UNEF
14S	.875 (22.22)	.083 (2.11)	.1662 (42.21)	--	.562 (14.27)	.906 (23.01)	1.188 (30.18)	.115 (2.92)	7/8-20UNEF
14	.875 (22.22)	.083 (2.11)	.1662 (42.21)	--	.750 (19.05)	.906 (23.01)	1.188 (20.18)	.115 (2.92)	7/8-20UNEF
16S	1.000 (25.40)	.083 (2.11)	.1662 (42.21)	--	.562 (14.27)	.969 (24.61)	1.281 (32.54)	.115 (2.92)	1-20UNEF
16	1.000 (25.40)	.083 (2.11)	.1662 (42.21)	1.937 (49.20)	.750 (19.05)	.969 (24.61)	1.281 (32.54)	.115 (2.92)	1-20UNEF
18	1.062 (26.67)	.125 (3.18)	.1662 (42.21)	1.937 (49.20)	.750 (19.05)	1.062 (26.97)	1.375 (34.92)	.115 (2.92)	1-1/8-18UNEF
20	1.187 (30.15)	.125 (3.18)	.1662 (42.21)	1.937 (49.20)	.750 (19.05)	1.156 (29.36)	1.500 (38.10)	.115 (2.92)	1-1/4-18UNEF
22	1.312 (33.32)	.125 (3.18)	.1662 (42.21)	1.937 (49.20)	.750 (19.05)	1.250 (31.75)	1.625 (41.28)	.115 (2.92)	1-3/8-18UNEF
24	1.437 (36.50)	.125 (3.18)	.1662 (42.21)	1.937 (49.20)	.812 (20.62)	1.375 (34.92)	1.750 (44.45)	.142 (3.61)	1-1/2-18UNEF
28	1.750 (44.45)	.125 (3.18)	.1662 (42.21)	1.937 (49.20)	.812 (20.62)	1.562 (39.67)	2.000 (50.80)	.142 (3.61)	1-3/4-18UNS
32	2.000 (50.80)	.125 (3.18)	.1662 (42.21)	1.937 (49.20)	.875 (22.22)	1.750 (44.45)	2.250 (57.18)	.168 (4.27)	2-18UNS
36	2.250 (57.15)	.125 (3.18)	.1662 (42.21)	1.937 (49.20)	.875 (22.22)	1.938 (49.23)	2.500 (63.50)	.168 (4.27)	2-1/4-16UN
40	2.500 (63.50)	.125 (3.18)	.1662 (42.21)	1.937 (49.20)	.875 (22.22)	2.188 (55.58)	2.750 (69.85)	.168 (4.27)	2-1/2-16UN
44	2.750 (69.85)	.125 (3.18)	.1662 (42.21)	1.937 (49.20)	.875 (22.22)	2.375 (60.32)	3.000 (76.20)	.168 (4.27)	2-3/4-16UN
48	3.000 (76.20)	.125 (3.18)	.1662 (42.21)	1.937 (49.20)	.875 (22.22)	2.625 (66.68)	3.250 (82.55)	.168 (4.27)	3-16UN

Performance Specifications - Page 189

Contacts, Sealing Plugs, Assembly Tools - Page 195

Contact Arrangements - Page 193-194

Cable Connecting Plug

MS3456

CV3456

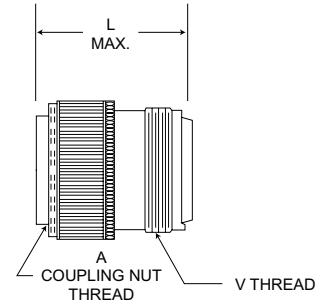
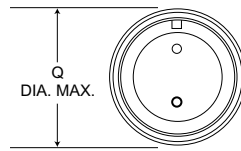

L Max.						L Max.					
Shell Size	Contact #16, #12, #8, #4	Contact #0	Q Dia. Max.	A Thread Class 2B	V Thread Class 2A	Shell Size	Contact #16, #12, #8, #4	Contact #0	Q Dia. Max.	A Thread Class 2B	V Thread Class 2A
8S	1.750 (44.45)	--	.844 (21.44)	1/2-28UNEF	1/2-20UNEF	18	2.100 (53.34)	--	1.344 (34.14)	1-1/8-18UNEF	1-1/16-18UNEF
10S	1.750 (44.45)	--	.969 (24.61)	5/8-24UNEF	5/8-24UNEF	20	2.100 (53.34)	2.250 (57.15)	1.469 (37.31)	1-1/4-18UNEF	1-3/16-18UNEF
10SL	1.750 (44.45)	--	.969 (24.61)	5/8-24UNEF	5/8-24UNEF	22	2.100 (53.34)	2.250 (57.15)	1.594 (40.49)	1-3/8-18UNEF	1-5/16-18UNEF
12S	1.750 (44.45)	--	1.062 (26.97)	3/4-20UNEF	3/4-20UNEF	24	2.100 (53.34)	2.250 (57.15)	1.719 (43.66)	1-1/2-18UNEF	1-7/16-18UNEF
12	2.100 (53.34)	--	1.062 (26.97)	3/4-20UNEF	3/4-20UNEF	28	2.100 (53.34)	2.250 (57.15)	1.969 (50.01)	1-3/4-18UNS	1-3/4-18UNS
14S	1.750 (44.45)	--	1.156 (29.36)	7/8-20UNEF	7/8-20UNEF	32	2.100 (53.34)	2.250 (57.15)	2.219 (56.36)	2-18UNS	2-18UNS
14	2.100 (53.34)	--	1.156 (29.36)	7/8-20UNEF	7/8-20UNEF	36	2.100 (53.34)	2.250 (57.15)	2.469 (62.71)	2-1/4-16UN	2-1/4-16UN
16S	1.750 (44.45)	--	1.250 (31.75)	1-20UNEF	1-20UNEF	40	2.100 (53.34)	2.250 (57.15)	2.719 (69.06)	2-1/2-16UN	2-1/2-16UN
16	2.100 (53.34)	--	1.250 (31.75)	1-20UNEF	1-20UNEF	44	2.100 (53.34)	2.250 (57.15)	2.969 (75.41)	2-3/4-16UN	2-3/4-16UN
						48	2.100 (53.34)	2.250 (57.15)	3.219 (81.76)	3-16UN	3-16UN

Cable Connecting Plug

MS3459

CV3459

Self-Locking Coupling Nut

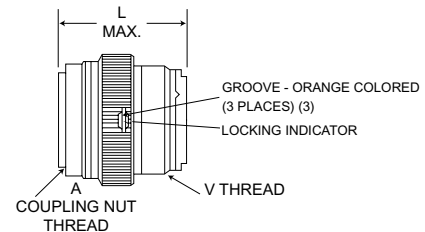
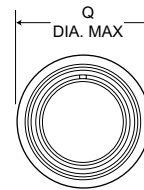

L Max.						L Max.					
Shell Size	Contact #16, #12, #8, #4	Contact #0	Q Dia. Max.	A Thread Class 2B	V Thread Class 2A	Shell Size	Contact #16, #12, #8, #4	Contact #0	Q Dia. Max.	A Thread Class 2B	V Thread Class 2A
8S	1.750 (44.45)	--	.963 (24.46)	1/2-28UNEF	1/2-20UNEF	16	2.100 (53.34)	--	1.463 (37.16)	1-20UNEF	1-20UNEF
10S	1.750 (44.45)	--	1.088 (27.64)	5/8-24UNEF	5/8-24UNEF	18	2.100 (53.34)	--	1.588 (40.34)	1-1/8-18UNEF	1-1/16-18UNEF
10SL	1.750 (44.45)	--	1.088 (27.64)	5/8-24UNEF	5/8-24UNEF	20	2.100 (53.34)	2.250 (57.15)	1.713 (43.51)	1-1/4-18UNEF	1-3/16-18UNEF
12S	1.750 (44.45)	--	1.213 (30.8)	3/4-20UNEF	3/4-20UNEF	22	2.100 (53.34)	2.250 (57.15)	1.788 (45.42)	1-3/8-18UNEF	1-5/16-18UNEF
12	2.100 (53.34)	--	1.213 (30.8)	3/4-20UNEF	3/4-20UNEF	24	2.100 (53.34)	2.250 (57.15)	1.963 (49.86)	1-1/2-18UNEF	1-7/16-18UNEF
14S	1.750 (44.45)	--	1.358 (34.49)	7/8-20UNEF	7/8-20UNEF	28	2.100 (53.34)	2.250 (57.15)	2.213 (56.21)	1-3/4-18UNS	1-3/4-18UNS
14	2.100 (53.34)	--	1.358 (34.49)	7/8-20UNEF	7/8-20UNEF	32	2.100 (53.34)	2.250 (57.15)	2.463 (62.56)	2-18UNS	2-18UNS
16S	1.750 (44.45)	--	1.463 (37.16)	1-20UNEF	1-20UNEF	36	2.100 (53.34)	2.250 (57.15)	2.713 (68.91)	2-1/4-16UN	2-1/4-16UN
						40	2.100 (53.34)	2.250 (57.15)	2.963 (75.26)	2-1/2-16UN	2-1/2-16UN

Performance Specifications - Page 189

Contacts, Sealing Plugs, Assembly Tools - Page 195

Contact Arrangements - Page 193-194

Contact Arrangements

Face view, Pin insert

Shell Size	8S-1	10S-2	10SL-4	10SL-3	12-5	12S-3	14S-9	14S-7
No. of Contacts	1 #16	1 #16	2 #16	3 #16	1 #12	2 #16	2 #16	3 #16
Service Rating	A	A	A	A	D	A	A	A

Shell Size	14S-2	14S-5	14S-6	16S-4	16-11	16-7	16-10	16-9
No. of Contacts	4 #16	5 #16	6 #16	2 #16	2 #12	2 #16 (A,B) 1 #8 (C)	3 #12 (A-C)	2 #16 (B,D) 2 #12 (A,C)
Service Rating	Inst.	Inst.	Inst.	D	A	A	A	A

Socket Only

Shell Size	16S-8	16S-1	18-22	18-4	18-10	18-11	18-12	18-9
No. of Contacts	5 #16	7 #16	3 #16	4 #16	4 #12	5 #12	6 #16	5 #16 (B,C,E-G) 2 #12 (A,D)
Service Rating	A	A	D	D	A	A	A	Inst.
					For new MIL equip. design, use 18-11		For new MIL equip. design, use 16S-1	

Shell Size	18-8	18-1	20-2	20-4	20-14	20-15	20-7	20-16
No. of Contacts	7 #16(A-G) 1 #12(H)	10 #16	1 #0	4 #12	3 #12(C,D,E) 2 #8(A,B)	7 #12	8 #16	7 #16(A-G) 2 #12(H,I)
Service Rating	A	A(B,C,F,G) Inst. (all others)	D	D	A	A	A(C-F) D(A,B,G,H)	A

Shell Size	20-18	20-27	20-29	22-2	22-22	22-13	22-5	22-18
No. of Contacts	6 #16 (A,C-E,G,H) 3 #12(B,F,I)	14 #16	17 #16	3 #8	4 #8	1 #16(E) 4 #12(A-D)	4 #16 (A,C,D,F) 2 #12(B,E)	8 #16
Service Rating	A	A	A	D	A	A(A-D), D(E)	D	A(C-E) D(all others)

Pin Only

Shell Size	22-16	22-19	22-14	24-4	24-22	24-10	24-11	24-20
No. of Contacts	6 #16 (A,B,F-J) 3 #12 (C-E)	14 #16	19 #16	3 #16 (B,C,D) 1 #0 (A)	4 #8	7 #8	6 #12(A-C,G-I) 3 #8(D-F)	9 #16(A-D,G-L) 2 #12(E,F)
Service Rating	A	A	A	D	D	A	A	D

Contact Arrangements (Continued)

Face view, pin insert

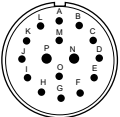
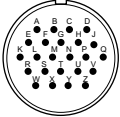
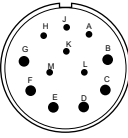
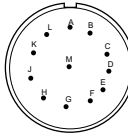
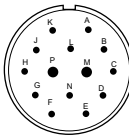
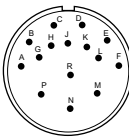
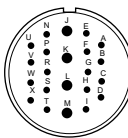
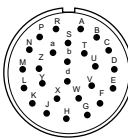
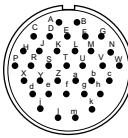
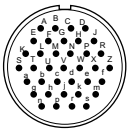
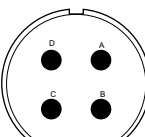
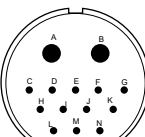
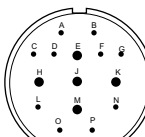
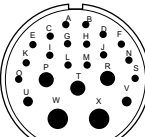
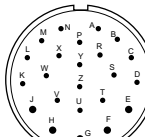
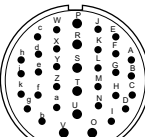
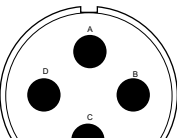
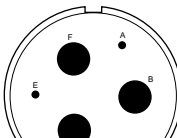
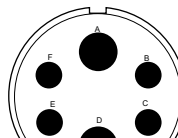
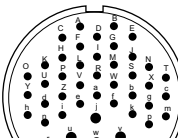
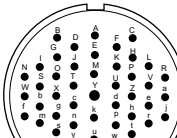
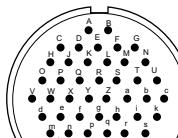
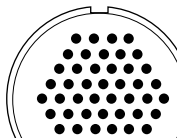
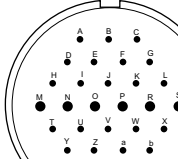
						
Shell Size	24-7	24-28	28-9	28-18		
No. of Contacts	14 #16(A-M,O) 2 #12(P,N)	24 #16	6 #16(A,H-M) 6 #12(B-G)	12 #		
Service Rating	A	Inst.	D	A (A,B) C(M) D (G-L) inst. (C-F)		
						
Shell Size	28-2	28-17	28-11	28-12	28-15	28-21
No. of Contacts	12 #16(A,L,N) 2 #12(M,P)	15 #16	18 #16(A-I, N-X) 4 #12(J-M)	26 #16	35 #16	37 #16
Service Rating	D	A(A-L), B(R) D(M-P)	A	A	A For MIL equip design, use 28-21	A
						
Shell Size	32-17	32-9	32-12	32-6	32-13	32-7
No. of Contacts	4 #4	12 #16(C-N) 2 #4(A,B)	10 #16 (A-D,F,G,L,N-P) 5 #12 (E,H,J,K,M)	16 #16(A-O,S) 2 #12(U,V) 3 #8(P,R,T) 2 #4(W,X)	18 #16 (A-D,K-Z) 5 #12 (E-J)	28 #16(A-N,W-Z,a-k) 7 #12(O-V)
Service Rating	D	D	A (C-G), D (all others)	A	D	Inst. (A,B,h,j) A(all others)
						
Shell Size	36-5	36-3	36-6	36-7	36-8	
No. of Contacts	4 #0	3 #12 (A,C,E) 3 #0 (B,D,F)	4 #4 (B,C,E,F) 2 #0(A,D)	40 #16(A-Z,a-s) 7 #12(t-z)	46 #16(A-X,Z-z) 1 #12(Y)	
Service Rating	A	D	A	A	A	
						
Shell Size	36-10	36-52	40-1			
No. of Contacts	48 #16	52 #16	24 #16 (A-L,T-e) 6 #12 (M-S)			
Service Rating	A	A	D			

Contacts

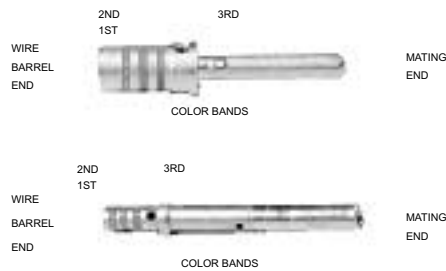

Pin, MIL-C-39029/29

BIN Code	Military Part Number	Color Bands			Mating End Size	Wire Barrel Size	ITT Cannon Part Number
		1st	2nd	3rd			
212	M39029/29-212	Red	Brown	Red	16	16	030-3196-008
213	M39029/29-213	Red	Brown	Orange	12	12	030-3197-007
214	M39029/29-214	Red	Brown	Yellow	8	8	030-3198-003
215	M39029/29-215	Red	Brown	Green	4	4	030-3199-004
216	M39029/29-216	Red	Brown	Blue	0	0	030-3200-003

Wire Hole Fillers

Contact Size	ITT Cannon Part Number	MS27488 Part Number	Color Code
16	225-0071-000	MS27488-16	Blue
12	225-0072-000	MS27488-12	Yellow
*8	225-1009-000	MS27488-8	Red
*4	225-1008-000	MS27488-4	Blue
*0	225-1007-000	MS27488-0	Yellow

* Consult factory for availability.

Socket, MIL-C-39029/30

BIN Code	Military Part Number	Color Bands			Mating End Size	Wire Barrel Size	ITT Cannon Part Number
		1st	2nd	3rd			
217	M39029/30-217	Red	Brown	Violet	16S	16	031-3113-005
218	M39029/30-218	Red	Brown	Gray	16	16	031-3114-008
219	M39029/30-219	Red	Brown	White	12	12	031-3115-006
220	M39029/30-220	Red	Red	Black	8	8	031-3116-003
212	M39029/30-221	Red	Red	Brown	4	4	031-3117-003
222	M39029/30-222	Red	Red	Red	0	0	031-3118-003

Thermocouple

Contact Size	Alumel		Chromel	
	Pin	Socket	Pin	Socket
16S*	030-3196-015	031-3113-011	030-3196-016	031-3113-012
16	030-3196-015	031-3114-014	030-3196-016	031-3114-015
12	030-3197-011	031-3115-009	030-3197-012	031-3115-010

*16S type socket contacts are for use in 8S, 10S, 10SL, 12S, 14S, and 16S shell size connectors.

Tooling

A complete line of crimp, insertion and extraction tools is provided for MIL-C-5015 connectors. Crimp tools are made from high quality metal and are designed for long life and trouble-free service. Insertion and extraction tools are made of a durable plastic and are inexpensive and expendable.



M22520/1-01



CIET-16

Contact Size	Insertion/Extraction Tools						Crimp Tool	Unwired Contact
	Plastic			Metal				
	MS No.	Part Number	ITT Cannon No.	MS No.	ITT Cannon No.			
16	M81969/14-03	274-7002-000	CIET-16-03	-	-	M22520/1-01 with M22520/1-02 Turret	274-7008-000	
12	M81969/14-04	274-7003-000	CIET-12-04	-	-	CBT 520/530	274-7009-000	
8	MS3165-8 M83723/32-8		CET 8-2	MS3483-1	CET-CVR-8	CBT 600B Power Unit CCH-8-1 Crimp Head CCHP-8-6 Locator	- - -	
4	MS3165-4 M83723/32-4		CET 4-8	MS3483-2	CET-CVR-4	CBT 600B Power Unit CCH-4-1 Crimp Head CCHP-4-8 Locator	- - -	
0	MS3165-0 M83723/32-0		CET 0-1	MS3483-3	CET-00-CV	CBT 600B Power Unit CCH-0-1 Crimp Head CCHP-0-8 Locator	- - -	



CBT-520/530



CBT-600

Cannon's MR waterproof connectors, designed to meet the requirements of MIL-C-5015, withstand conditions involving mud, ice, and water. They are particularly suited for missile ground support equipment, radar installations, heavy construction installations, and outdoor applications involving rapid transit, radio/tv stations, and marine equipment. Maximum resistance to severe environmental conditions is assured by an O-ring seal around the mated insert faces, and a gland seal at the cable

entry which provides a cable strain relief as well. When properly terminated to a jacketed cable, a mated pair of MR connectors can be immersed in depths of 150 feet in fresh water. For other immersion media consult factory.

The MR connector series is supplied with MIL-C-5015 resilient insulators and solder pot contacts. For crimp type contacts refer to the ordering information below. MS contact arrangements, coupling threads, and sizes are standard to

MIL-C-5015. Simple maintenance under severe conditions is possible with a convenient, long, knurled coupling nut and endbell that can be easily removed by standard open end wrenches. Dust caps have attached head chains to prevent kinking.

Operating temperature range of connectors - 55°C (-67°F) to 125°C (257°F). The upper temperature is the maximum internal hot spot temperature resulting from any combination of electrical load and ambient temperature.

Performance and Material Specifications

MATERIALS

- Shell - Aluminum alloy
- Insulator - Synthetic elastomer
- Contacts - Copper alloy

FINISHES

- Shell - Clear anodized
- Contacts - Silver plate

MECHANICAL FEATURES

- Shell Styles
- 00 - Wall Mounting Receptacle
 - 01 - Cable Connecting Receptacle
 - 02 - Chassis Mounting Receptacle
 - 06 - Cable Connecting Straight Plug

- Shell Size - 14S thru 36
- Coupling - Threaded

Cable Entry - 00, 01, and 06 accommodate cables from - 3 (3/16") to -28 (1-3/4") in sixteenths of an inch. Shell style 02 requires no jacketed cable seal.

- Polarization - Single keyway

ELECTRICAL DATA

Number of Contacts - 1 thru 66

TEST CURRENT

Maximum current ratings of contacts and maximum allowable voltage drop under test conditions when assembled as in service are shown below. Maximum total current to be carried per connector is the same as the allowable in wire bundles as specified in MIL-W-5088.

Contact Size	Test Current (Amps)	Potential Drop (millivolts)
16	20	21
12	35	20
8	60	12
4	110	10
0	200	10

HIGH POTENTIAL TEST VOLTAGE

MS connectors show no evidence of breakdown when the test voltage given below is applied between the two closest contacts and between the shell and the contact closest to the shell for a period of one minute.

MS Service Rating	Test Voltage (rms) 60 cps	Suggested Operating Voltage* DC	Suggested Operating Voltage* AC (rms)	Air Spacing nom. in.
Inst.	1000	250	200	-
A	2000	700	500	1/16
D	2800	1250	900	1/8
E	3500	1750	1250	3/16
B	4500	2450	1750	1/4
C	7000	4200	3000	5/16

* As indicated in MS Specifications and to be used by the designer only as a guide

How to Order

SERIES PREFIX

- MR - Resilient Insulator

SHELL STYLE

- 00 - Wall Mounting Receptacle
- 01 - Cable Connecting Receptacle
- 02 - Chassis Mounting Receptacle
- 06 - Cable Connecting Straight Plug

SHELL SIZE

- 14S, 16S, 18, 20, 22, 24, 28, 32, and 36

CONTACT ARRANGEMENTS

- 1 to 56 contacts
(See pages 171-174 for MSE/R)

SERIES PREFIX

SHELL STYLE

SHELL SIZE

CONTACT ARRANGEMENTS

CONTACT TYPE

ALTERNATE INSERT POSITION

CABLE ENTRY

MODIFICATIONS

CONTACT TYPE

- P for Pin; S for socket

ALTERNATE INSERT POSITION

- W, X, Y, and Z per MIL-C-5015

CABLE ENTRY

- 00, 01, and 06 shell styles accommodate cables from - 3 (3/16") to - 28 (1-3/4") graduated in sixteenths of an inch. The 02 shell style requires no jacketed cable seal.

MODIFICATIONS

- FO - Less contacts
- A66 - Olive drab cadmim
- A105 - Clear Cadmium
- F80 - Crimp contacts
- F111 - Stainless steel 303 hardware & link chain (F135)
- F135 - Stainless steel link chain
- F150 - Less dust cap and chain
- For other modifications, such as cable grips and peripheral ground adapters, consult the factory.

MR 06 28 12 P X 18 *

Wall Mounting Receptacle

MR00

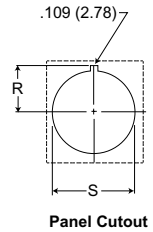
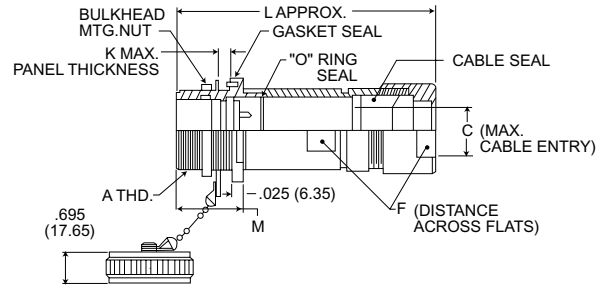
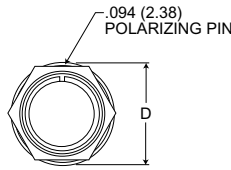

Shell Size	A Thread	C	D	F	K	L	M	R	S
14S	7/8-20NEF-2A	.187 to .480 (4.76 to 12.20)	1.375 (34.92)	.745 (18.92)	.156 (3.97)	4.125 (104.78)	1.063 (26.99)	.546 (13.89)	.906 (23.02)
16S	1-20NEF-2A	.250 to .563 (6.35 to 14.29)	1.500 (38.10)	.870 (22.10)	.156 (3.97)	4.250 (107.95)	1.063 (26.99)	.609 (15.47)	1.031 (26.19)
18	1-1/8-18NEF-2A	.250 to .750 (6.35 to 19.05)	1.625 (41.28)	.995 (25.27)	.250 (6.35)	5.063 (128.59)	1.406 (35.72)	.671 (17.06)	1.156 (29.37)
20	1-1/4-18NEF-2A	.250 to .750 (6.35 to 19.05)	1.750 (44.45)	.995 (25.27)	.250 (6.35)	5.188 (131.76)	1.406 (35.72)	.734 (18.64)	1.281 (32.54)
22	1-3/8-18NEF-2A	.250 to 1.000 (6.35 to 25.40)	1.875 (47.62)	1.245 (31.62)	.250 (6.35)	5.313 (134.94)	1.406 (35.72)	.796 (20.22)	1.406 (35.72)
24	1-1/2-18NEF-2A	.250 to 1.00 (6.35 to 25.40)	2.000 (50.80)	1.245 (31.62)	.219 (5.56)	5.438 (138.11)	1.406 (35.72)	.857 (21.82)	1.531 (38.89)
28	1-3/4-18NS-2A	.312 to 1.250 (7.94 to 31.75)	2.250 (57.15)	1.495 (37.97)	.219 (5.56)	5.563 (141.29)	1.406 (35.72)	.989 (24.99)	1.781 (45.24)
32	2-18NS-2A	.750 to 1.500 (19.05 to 38.10)	2.500 (63.50)	1.807 (45.90)	.219 (5.56)	5.688 (144.46)	1.406 (35.72)	1.109 (26.17)	2.031 (51.59)
36	2-1/4-16UN-2A	.750 to 1.750 (19.05 to 44.45)	2.750 (69.85)	2.058 (52.27)	.156 (3.97)	5.750 (146.05)	1.406 (35.72)	1.234 (31.34)	2.281 (57.94)

Cable Connecting Plug

MR01

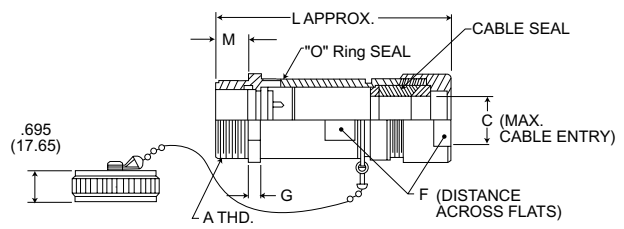
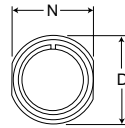

Shell Size	A Thread	C	D	F	G	L	M	N
14S	7/8-20NEF-2A	.187 to .480 (4.76 to 12.20)	1.094 (27.78)	.745 (18.92)	.180 (4.57)	3.656 (92.87)	.496 (11.91)	.875 (23.22)
16S	1-20NEF-2A	.250 to .563 (6.35 to 14.29)	1.219 (30.96)	.870 (22.10)	.250 (6.35)	4.000 (101.60)	.531 (13.49)	1.000 (25.40)
18	1-1/8-18NEF-2A	.250 to .750 (6.35 to 19.05)	1.344 (34.13)	.995 (25.27)	.250 (6.35)	4.625 (117.48)	.719 (18.26)	1.125 (28.58)
20	1-1/4-18NEF-2A	.250 to .750 (6.35 to 19.05)	1.469 (37.31)	.995 (25.27)	.250 (6.35)	4.750 (120.65)	.719 (18.26)	1.250 (31.75)
22	1-3/8-18NEF-2A	.250 to 1.000 (6.35 to 25.40)	1.594 (40.48)	1.245 (31.62)	.250 (6.35)	4.875 (123.83)	.719 (18.26)	1.375 (34.92)
24	1-1/2-18NEF-2A	.250 to 1.00 (6.35 to 25.40)	1.719 (43.66)	1.245 (31.62)	.250 (6.35)	5.000 (127.00)	.719 (18.26)	1.500 (38.10)
28	1-3/4-18NS-2A	.312 to 1.250 (7.94 to 31.75)	1.969 (50.01)	1.495 (37.97)	.250 (6.35)	5.125 (130.18)	.719 (18.26)	1.750 (44.45)
32	2-18NS-2A	.750 to 1.500 (19.05 to 38.10)	2.219 (56.36)	1.807 (45.90)	.250 (6.35)	5.250 (133.35)	.719 (18.26)	2.000 (50.80)
36	2-1/4-16UN-2A	.750 to 1.750 (19.05 to 44.45)	2.469 (62.71)	2.058 (52.27)	.250 (6.35)	5.375 (136.52)	.719 (18.26)	2.250 (57.15)

Chassis Mounting Receptacle

MR02

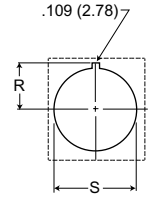
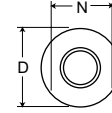
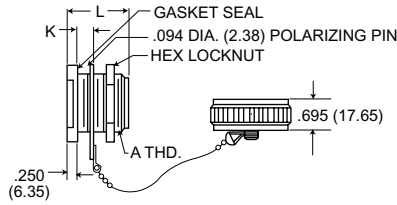

Panel Cutout

Shell Size	A Thread	D	K	L	N	R	S
14S	7/8-20NEF-2A	1.375 (34.92)	.156 (3.97)	1.063 (26.99)	1.125 (28.56)	.546 (13.89)	.906 (23.02)
16S	1-20NEF-2A	1.500 (38.10)	.156 (3.97)	1.063 (26.99)	1.250 (31.75)	.609 (15.47)	1.031 (26.19)
18	1-1/8-18NEF-2A	1.625 (41.28)	.250 (6.35)	1.406 (35.72)	1.375 (34.92)	.671 (17.06)	1.156 (29.37)
20	1-1/4-18NEF-2A	1.750 (44.45)	.250 (6.35)	1.406 (35.72)	1.438 (36.51)	.734 (18.64)	1.281 (32.54)
22	1-3/8-18NEF-2A	1.875 (47.62)	.250 (6.35)	1.406 (35.72)	1.500 (38.10)	.796 (20.22)	1.406 (35.72)
24	1-1/2-18NEF-2A	2.000 (50.80)	.219 (5.56)	1.406 (35.72)	1.625 (41.28)	.857 (21.82)	1.531 (38.89)
28	1-3/4-18NS-2A	2.250 (57.15)	.219 (5.56)	1.406 (35.72)	1.750 (44.45)	.989 (24.99)	1.781 (45.24)
32	2-18NS-2A	2.500 (63.50)	.219 (5.56)	1.406 (35.72)	2.000 (50.80)	1.109 (26.17)	2.031 (51.59)
36	2-1/4-16UN-2A	2.750 (69.85)	.156 (3.97)	1.406 (35.72)	2.375 (60.32)	1.234 (31.34)	2.281 (57.94)

Cord Connecting Straight Plug

MR06

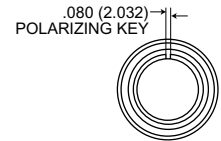
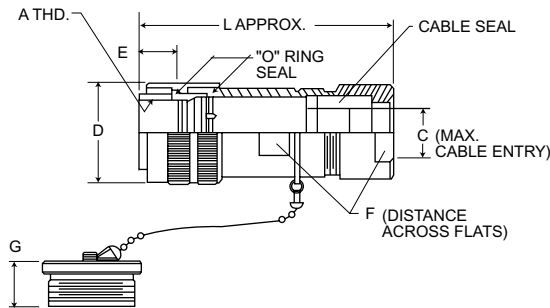

Shell Size	A Thread	C	D	E	F	G	L
14S	7/8-20NEF-2B	.187 to .480 (4.76 to 12.20)	1.125 (28.58)	.531 (13.49)	.745 (18.92)	.712 (18.09)	3.750 (95.25)
16S	1-20NEF-2B	.250 to .563 (6.35 to 14.29)	1.250 (31.75)	.531 (13.49)	.870 (22.10)	.712 (18.09)	3.875 (98.42)
18	1-1/8-18NEF-2B	.250 to .750 (6.35 to 19.05)	1.375 (34.92)	.718 (18.24)	.995 (25.27)	.900 (22.86)	4.563 (115.59)
20	1-1/4-18NEF-2B	.250 to .750 (6.35 to 19.05)	1.500 (38.10)	.718 (18.24)	.995 (25.27)	.900 (22.86)	4.688 (119.06)
22	1-3/8-18NEF-2B	.250 to 1.000 (6.35 to 25.40)	1.625 (41.28)	.718 (18.24)	1.245 (31.62)	.900 (22.86)	4.813 (122.24)
24	1-1/2-18NEF-2B	.250 to 1.00 (6.35 to 25.40)	1.750 (44.45)	.718 (18.24)	1.245 (31.62)	.900 (22.86)	4.938 (125.41)
28	1-3/4-18NS-2B	.312 to 1.250 (7.94 to 31.75)	2.000 (50.80)	.718 (18.24)	1.495 (37.97)	.900 (22.86)	5.063 (128.59)
32	2-18NS-2B	.750 to 1.500 (19.05 to 38.10)	2.250 (57.15)	.718 (18.24)	1.807 (45.90)	.900 (22.86)	5.188 (131.76)
36	2-1/4-16UN-2B	.750 to 1.750 (19.05 to 44.45)	2.500 (63.50)	.718 (18.24)	2.058 (52.27)	.900 (22.86)	5.313 (134.94)

CA-A connectors were originally designed and approved under Military Specifications for use in military aircraft. Since then, commercial and industrial demand for these connectors has grown because of their uniform quality, dependability, and interchangeability as prescribed in MIL-C-5015.

CA-A connectors are available as plugs or receptacles. The term plug applies to any assembly fixed to

the end of a cable. The term receptacle applies to any assembly mounted to a wall or box. CA shells will accept either pin or socket insert assemblies. Socket contacts are the closed-entry type.

Each contact arrangement is available with pin or socket contacts and will mate with all MS type connectors having the same size and contact arrangements.

Performance and Material Specifications

ELECTRICAL

Maximum current ratings of contacts and maximum allowable voltage drop under test conditions when assembled as in service are shown below.

Contact Size	Test Current (amps)	Potential Drop (millivolts)
16	13	49
12	23	42
8	46	26
4	80	23
0	150	21

MATERIALS AND FINISHES

Shell	Material	Aluminum alloy
	Finish	Olive drab chromate coating over cadmium plating
Insulator	Material	Thermoset Plastic (resilient insulators are available)
	Termination	Tinned solder pot
Contacts	Material	Brass or copper alloy
	Finish	Silver plate

How to Order

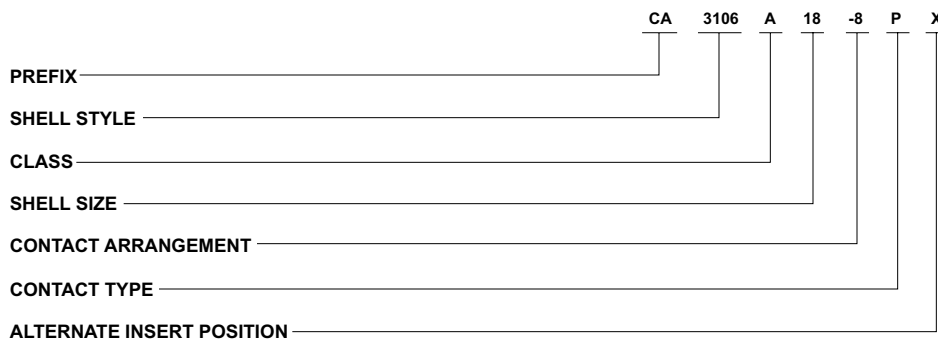

PREFIX

CA - ITT Cannon prefix.

SHELL STYLE

3102 - Box mounting receptacle
3106 - Straight plug
Consult factory for additional shell styles.

CLASS

A - Solid or one-piece endbell

SHELL SIZE

Coupling thread diameter in sixteenths of an inch

CONTACT ARRANGEMENTS

See page 201.
Consult factory for additional layouts.

CONTACT ARRANGEMENTS

P for Pin; S for Socket

ALTERNATE INSERT POSITIONS

Consult factory

Box Mounting Receptacle

CA3102A (Available with plastic or resilient insulators)

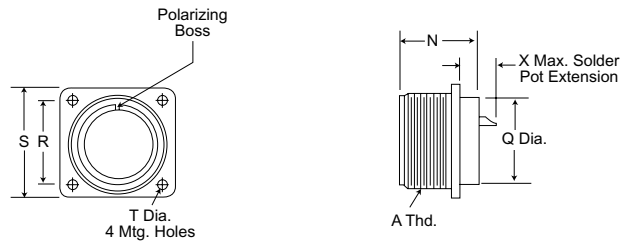

The CA3102A box mounting receptacles are used on boxes and equipment cases where no cable support is required.

Straight Plug

CA3102A Solid Endbell

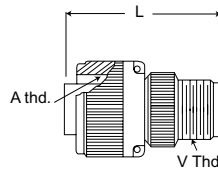
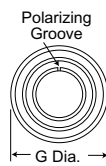

Sizes 10SL thru 16S

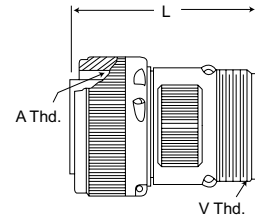



















Sizes 18 thru 24

CA3106A straight plugs are used with 3100 and 3102 receptacles and 3101 plugs.

Shell Size	G Max.	L Max.	N Max.	Q Max.	R ±.005	S Max.	T +.010 - .005	A Thread	V Thread
10SL	.969 (24.62)	1.531 (38.89)	1.000 (25.40)	.630 (16.00)	.719 (18.26)	1.031 (26.19)	.120 (3.05)	5/8-24NEF-2B	5/8-24NEF-2A
12S	1.062 (26.97)	1.688 (42.88)	1.000 (25.40)	.630 (16.00)	.812 (20.62)	1.125 (28.58)	.120 (3.05)	3/4-20UNEF-2B	5/8-24NEF-2A
14S	1.156 (29.36)	1.688 (42.88)	1.000 (25.40)	.755 (19.18)	.906 (23.01)	1.219 (30.96)	.120 (3.05)	7/8-20UNEF-2B	3/4-20UNEF-2A
16S	1.250 (31.75)	1.688 (42.88)	1.000 (25.40)	.880 (22.35)	.969 (24.62)	1.312 (33.32)	.120 (3.05)	1-20UNEF-2B	7/8-20UNEF-2A
18	1.344 (34.14)	2.062 (52.37)	1.205 (30.61)	.989 (25.13)	1.062 (26.97)	1.406 (35.71)	.120 (3.05)	1-1/8-18NEF-2B	1-20UNEF-2A
20	1.469 (37.31)	2.188 (55.58)	1.205 (30.61)	1.176 (29.87)	1.156 (29.36)	1.531 (38.89)	.120 (3.05)	1-1/4-18NEF-2B	1-3/16-18NEF-2A
22	1.594 (40.49)	2.188 (55.58)	1.205 (30.61)	1.270 (32.26)	1.250 (31.75)	1.656 (42.06)	.120 (3.05)	1-3/8-18NEF-2B	1-3/16-18NEF-2A
24	1.719 (43.66)	2.312 (58.72)	1.375 (34.92)	1.395 (35.43)	1.375 (34.92)	1.781 (45.24)	.147 (3.73)	1-1/2-18NEF-2B	1-7/16-18NEF-2A

Shell Size	X DIMENSION Max. Solder Pot Ext. - Pin or Socket				
	16	12	8	4	0
10SL-16S	.50 (12.70)	-	-	-	-
18-22	.50 (12.70)	.59 (14.99)	.72 (18.29)	.86 (21.84)	.86 (21.84)
24	.59 (14.99)	.65 (16.51)	.76 (19.30)	.90 (22.86)	.90 (22.86)

Contact Arrangements (Face View, Pin Insert)

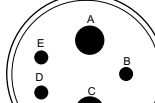
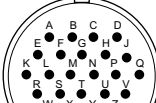
Shell Size							
No. of Contacts	10SL-4 2 #16	10SL-3 3 #16	12S-3 2 #16	14S-9 2 #16	14S-1 3 #16	14S-7 3 #16	14S-2 4 #16
Service Rating	A	A	A	A	A	A	Inst.
Shell Size							
No. of Contacts	14S-5 5 #16	14-6 6 #16	16S-4 2 #16	16S-1 7 #16	18-4 4 #16	18-12 6 #16	18-8 7 #16(A-G) 1 #12(H)
Service Rating	Inst.	Inst.	D	A	D	A	A
Shell Size							
No. of Contacts	18-1 10 #16	20-27 14 #16	20-29 17 #16	22-14 19 #16	24-12 3 #12(B,D,E) 2 #4(A,C)	24-28 24 #16	
Service Rating	A(B,C,F,G) Inst. (all others)	A	A	A	A	Inst.	

Junction Shell

CA2120

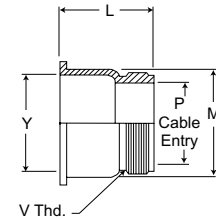
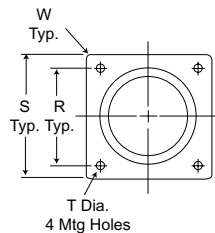

The CA2120 straight junction shell is used with CA3102 box mounting receptacle to protect and enclose the wires behind a panel or bulkhead and to connect flexible or rigid conduit. Material in aluminum alloy; finish is olive drab chromate over cadmium plate.

Part Number	Fits Shell Size	L Max.	M Max.	P Max.	R ±.005	S Max.	T +.010 -.005	Y Max.	V thread	W Rad. Max.
CA2120-2A	10SL	.749 (19.02)	.782 (19.86)	.430 (10.92)	.718 (18.24)	1.031 (26.19)	.120 (3.05)	.655 (16.64)	5/8-24UNEF-2A	.155 (3.68)
CA2120-3	12S	.811 (20.60)	.782 (19.86)	.430 (10.92)	.813 (20.62)	1.125 (28.58)	.120 (3.05)	.655 (16.64)	5/8-24UNEF-2A	.155 (3.68)
CA2120-4	14S	.812 (20.62)	.906 (23.01)	.550 (13.97)	.906 (23.01)	1.219 (30.96)	.120 (3.05)	.772 (19.61)	3/4-20UNEF-2A	.155 (3.68)
CA2120-5	16S	.890 (22.61)	1.032 (26.21)	.679 (17.25)	.968 (24.59)	1.312 (33.32)	.120 (3.05)	.896 (22.76)	7/8-20UNEF-2A	.155 (3.68)
CA2120-9	18	1.119 (28.42)	1.156 (29.36)	.780 (19.81)	1.062 (26.97)	1.406 (35.71)	.120 (3.05)	1.004 (25.50)	1-20UNEF-2A	.175 (4.44)
CA2120-10	20	1.276 (32.41)	1.282 (32.56)	.890 (22.61)	1.156 (29.36)	1.531 (38.89)	.120 (3.05)	1.192 (30.28)	1-3/16-18UNEF-2A	.185 (4.70)
CA2120-11	22	1.244 (31.60)	1.406 (35.71)	.900 (22.86)	1.250 (31.75)	1.656 (42.06)	.120 (3.05)	1.285 (32.64)	1-3/16-18UNEF-2A	2.05 (5.21)
CA2120-12	24	1.354 (34.39)	1.532 (38.92)	1.150 (29.21)	1.375 (34.92)	1.781 (45.24)	.147 (3.73)	1.411 (35.84)	1-7/16-18UNEF-2A	.205 (5.21)

MS-K firewall connectors have met and are qualified to the fireproof test of MIL-C-5015. This test requires that a connector mounted to a firewall will continue to operate for 5 minutes in case of fire and

prevent the passage of flame for 20 minutes. These connectors are not environmentally sealed but operate continuously at temperature up to +177°C (+350°F). MS-K connectors have crimp type con-

tacts; thermocouple contacts must be ordered separately and are solder type unless otherwise requested on order. Cavities that will contain the thermocouple contacts and contact material must be specified when ordering.

Performance and Material Specifications

MATERIALS

Shell - Steel
 Insulator - Glass-filled epoxy or glass-filled melamine or melamine glass cloth laminate
 Contacts - Copper alloy

FINISHES

Shell - Olive drab over cadmium plate
 Contacts - Silver plate

MECHANICAL FEATURES

Shell Size - In sixteenths of an inch
 Coupling - Threaded
 Contact Arrangements - See pages 216-217

ELECTRICAL DATA

Number of Contacts - 1 thru 37

How to Order

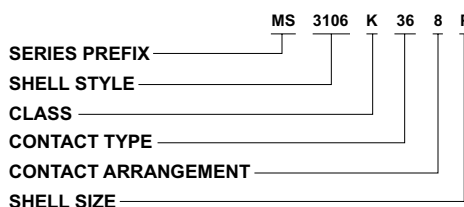

SERIES PREFIX
MS
SHELL STYLE
See pages 202-204
CLASS
K per MIL-C-5015

SHELL SIZE
8S to 36
CONTACT ARRANGEMENT
See pages 216-217
CONTACT TYPE
P for pin; S for socket

Wall Mounting Receptacle

MS3100K

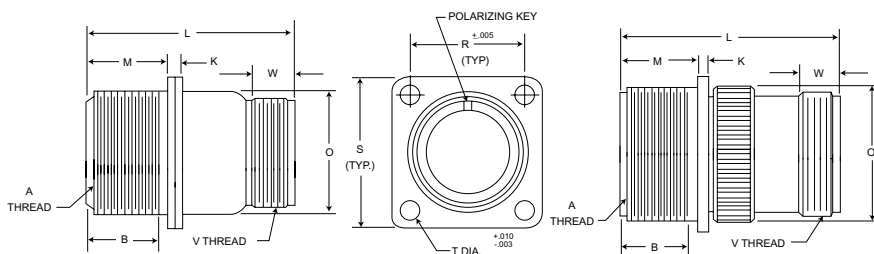

Sizes 8S to 18 have junction shell

Sizes 20 to 36 have endbell

Part Number	B	K	L	M	O	R	S	T	W
MS3100K8S-†	.375 (9.52)	.125 (3.18)	1.453 (36.91)	.563 (14.30)	17/32	19/32	7/8	.150 (3.81)	.375 (9.52)
•MS3100K10SL-†	.375 (9.52)	.125 (3.18)	1.109 (28.17)	.563 (14.30)	25/32	23/32	1	.150 (3.81)	.375 (9.52)
MS3100K12S-†	.375 (9.52)	.125 (3.18)	1.515 (38.48)	.563 (14.30)	25/32	13/16	1-3/32	.150 (3.81)	.375 (9.52)
MS3100K14S-†	.375 (9.52)	.125 (3.18)	1.515 (38.48)	.563 (14.30)	29/32	29/32	1-3/16	.150 (3.81)	.375 (9.52)
MS3100K16S-†	.375 (9.52)	.125 (3.18)	1.703 (43.26)	.563 (14.30)	1-1/32	31/32	1-9/32	.150 (3.81)	.375 (9.52)
MS3100K16-†	.625 (15.88)	.125 (3.18)	1.703 (43.26)	.750 (19.05)	1-1/32	31/32	1-9/32	.150 (3.81)	.375 (9.52)
MS3100K18-†	.625 (15.88)	.125 (3.18)	1.921 (48.79)	.750 (19.05)	1-5/32	1-1/16	1-3/8	.177 (4.50)	.375 (9.52)
MS3100K20-†	.625 (15.88)	.078 (1.98)	2.109 (53.57)	.750 (19.05)	1-21/64	1-5/32	1-1/2	.177 (4.50)	.375 (9.52)
MS3100K22-†	.625 (15.88)	.078 (1.98)	2.031 (51.59)	.750 (19.05)	1-25/64	1-1/4	1-5/8	.177 (4.50)	.375 (9.52)
MS3100K24-†	.625 (15.88)	.078 (1.98)	2.328 (59.13)	.813 (20.65)	1-37/64	1-3/8	1-3/4	.177 (4.50)	.375 (9.52)
MS3100K28-†	.625 (15.88)	.078 (1.98)	2.025 (51.44)	.813 (20.65)	1-49/64	1-9/16	2	.177 (4.50)	.375 (9.52)
MS3100K32-†	.625 (15.88)	.078 (1.98)	2.453 (62.31)	.875 (22.22)	2-1/64	1-3/4	2-1/4	.209 (5.31)	.438 (11.13)
MS3100K36-†	.625 (15.88)	.125 (3.18)	2.594 (65.89)	.875 (22.22)	2-17/64	1-15/16	2-1/2	.209 (5.31)	.500 (12.70)

* Receptacles in size 10SL are available with pin inserts only.

* Add contact arrangement. See pages 216-217.

† Add contact type: P - pin; S - socket.

Part Number	A Thread	V Thread
MS3100K8S-†	1/2-28UNEF-2A	1/2-28UNEF-2A
MS3100K10SL-†	5/8-24UNEF-2A	5/8-24UNEF-2A
MS3100K12S-†	3/4-20UNEF-2A	5/8-24UNEF-2A
MS3100K14S-†	7/8-20UNEF-2A	3/4-20UNEF-2A
MS3100K16S-†	1-20UNEF-2A	7/8-20UNEF-2A
MS3100K16-†	1-20UNEF-2A	7/8-20UNEF-2A
MS3100K18-†	1-1/8-18UNEF-2A	1-20UNEF-2A
MS3100K20-†	1-1/4-18UNEF-2A	1-3/16-18UNEF-2A
MS3100K22-†	1-3/8-18UNEF-2A	1-3/16-18UNEF-2A
MS3100K24-†	1-1/2-18UNEF-2A	1-7/16-18UNEF-2A
MS3100K28-†	1-3/4-18UNS-2A	1-7/16-18UNEF-2A
MS3100K32-†	2-18UNS-2A	13/4-18UNS-2A
MS3100K36-†	2-1/4-16UN-2A	2-18UNS-2A

Dimensions are shown in inches (millimeters).
 Dimensions subject to change.

www.ittcannon.com

Box Mounting Receptacle

MS3102K

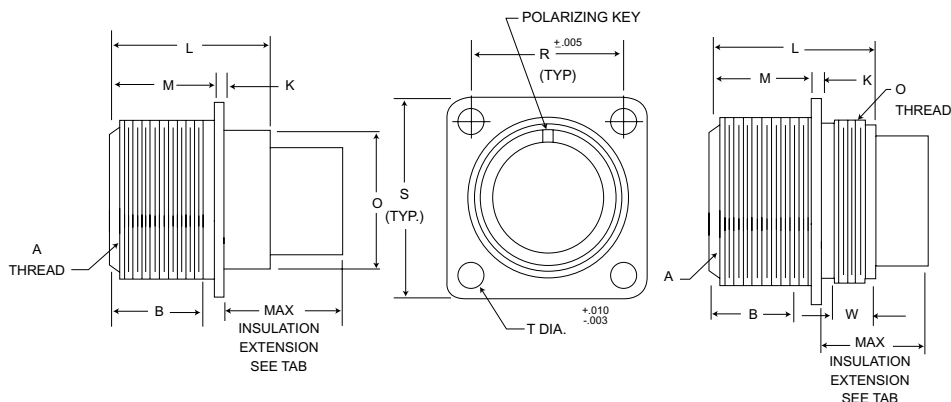

Sizes 8S to 18 have plain rear skirt

Sizes 20 to 36 have threaded rear skirt

Maximum Insulation Extensions

Shell Size	Contact Size			
	16	12	8	4 0
8S	11/16	-	-	-
10SL-16S	51/64	7/8	-	-
16-18	13/16	7/8	7/8	1-3/32 -
20-22	13/16	7/8	7/8	1-3/32 1-9/64
24	47/64	13/16	13/16	1-3/32 1-3/32
28	47/64	13/16	13/16	1-3/32 1-3/32
32	47/64	47/64	47/64	61/64 1-1/32
36	39/64	43/64	43/64	57/64 61/64

Part Number	A Thread	B	K	L	M	O Thread	R	S	T	W
MS3102K8S-†	1/2-28UNEF-2A	.375 (9.52)	.063 (1.90)	59/64	.563 (14.30)	7/16	19/32	7/8	.150 (3.81)	-
•MS3102K10SL-†	5/8-24UNEF-2A	.375 (9.52)	.063 (1.90)	61/64	.563 (14.30)	39/64	23/32	1	.150 (3.81)	-
MS3102K12S-†	3/4-20UNEF-2A	.375 (9.52)	.063 (1.90)	61/64	.563 (14.30)	21/32	13/16	1-3/32	.150 (3.81)	-
MS3102K14S-†	7/8-20UNEF-2A	.375 (9.52)	.063 (1.90)	61/64	.563 (14.30)	23/32	29/32	1-3/16	.150 (3.81)	-
MS3102K16S-†	1-20UNEF-2A	.375 (9.52)	.063 (1.90)	61/64	.563 (14.30)	27/32	31/32	1-9/32	.150 (3.81)	-
MS3102K16-†	1-20UNEF-2A	.625 (15.88)	.063 (1.90)	1-9/64	.750 (19.05)	27/32	31/32	1-9/32	.150 (3.81)	-
MS3102K18-†	1-1/8-18UNEF-2A	.625 (15.88)	.063 (1.90)	1-9/64	.750 (19.05)	31/32	1-1/16	1-3/8	.177 (4.50)	-
MS3102K20-†	1-1/4-18UNEF-2A	.625 (15.88)	.078 (1.98)	1-15/64	.750 (19.05)	1-3/16-18UNEF-2A	1-5/32	1-1/2	.177 (4.50)	.141 (3.58)
MS3102K22-†	1-3/8-18UNEF-2A	.625 (15.88)	.078 (1.98)	1-18/64	.750 (19.05)	1-1/4-18UNEF-2A	1-1/4	1-5/8	.177 (4.50)	.141 (3.58)
MS3102K24-†	1-1/2-18UNEF-2A	.625 (15.88)	.078 (1.98)	1-18/64	.813 (20.65)	1-7/16 18UNEF-2A	1-3/8	1-3/4	.177 (4.50)	.141 (3.58)
MS3102K28-†	1-3/4-18UNS-2A	.625 (15.88)	.078 (1.98)	1-18/64	.813 (20.65)	1-5/8-18UNEF-2A	1-9/16	2	.177 (4.50)	.141 (3.58)
MS3102K32-†	2-18UNS-2A	.625 (15.88)	.078 (1.98)	1-3/8	.875 (22.22)	1-7/8-16UN-2A	1-3/4	2-1/4	.209 (5.31)	.313 (7.95)
MS3102K36-†	2-1/4-16UN-2A	.625 (15.88)	.125 (3.18)	1-29/64	.875 (22.22)	2-1/8-16UN-2A	1-15/16	2-1/2	.209 (5.31)	.344 (8.74)

* Receptacles in size 10SL are available with pin inserts only.

† Add contact type: P - pin; S - socket.

* Add contact arrangements. See pages 216-217.

Straight Plug

MS3106K
Pin Insert



Socket Insert

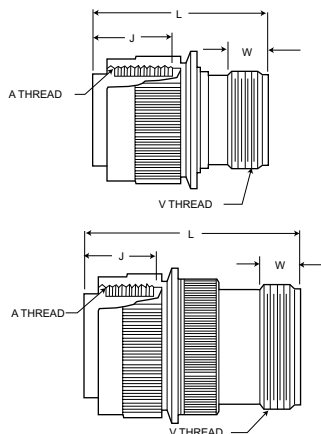

Sizes 8S to 16 - one piece construction

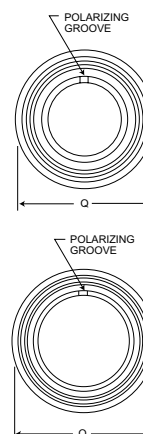

Sizes 18 to 36 - two piece construction

Part Number	A Thread	J	L	Q	V Thread	W
MS3106K8S-†	1/2-28UNEF-2B	.531 (13.49)	1-1/4	3/4	1/2-28UNEF-2A	.375 (9.52)
MS3106K10SL-†	5/8-24UNEF-2B	.531 (13.49)	1-7/16	31/32	5/8-24UNEF-2A	.375 (9.52)
MS3106K12S-†	3/4-20UNEF-2B	.531 (13.49)	1-7/16	1	5/8-24UNEF-2A	.375 (9.52)
MS3106K14S-†	7/8-20UNEF-2B	.531 (13.49)	1-7/16	1-1/8	3/4-20UNEF-2A	.375 (9.52)
MS3106K16S-†	1-20UNEF-2B	.531 (13.49)	1-7/16	1-1/4	7/8-20UNEF-2A	.375 (9.52)
MS3106K16-†	1-20UNEF-2B	.719 (18.26)	1-5/8	1-1/4	7/8-20UNEF-2A	.375 (9.52)
MS3106K18-†	1-1/8-18UNEF-2B	.719 (18.26)	2-1/16	1-11/32	1-20UNEF-2A	.375 (9.52)
MS3106K20-†	1-1/4-18UNEF-2B	.719 (18.26)	2-11/64	1-15/32	1-3/16-18UNEF-2A	.375 (9.52)
MS3106K22-†	1-3/8-18UNEF-2B	.719 (18.26)	2-5/32	1-19/32	1-3/16-18UNEF-2A	.375 (9.52)
MS3106K24-†	1-1/2-18UNEF-2B	.719 (18.26)	2-21/64	1-23/32	1-7/16-18UNEF-2A	.375 (9.52)
MS3106K28-†	1-3/4-18UNS-2B	.719 (18.26)	2-5/16	1-31/32	1-7/16-18UNEF-2A	.375 (9.52)
MS3106K32-†	2-18UNS-2B	.719 (18.26)	2-25/64	2-7/32	1-3/4-18UNS-2A	.438 (11.13)
MS3106K36-†	2-1/4-16UN-2B	.719 (18.26)	2-17/32	2-15/32	2-18UNS-2A	.500 (12.70)

• Plugs in size 10SL are available with socket inserts only.
* Add contact arrangements. See pages 216-217.

† Add contact type: P - pin; S - socket.

90° Angle Plug

MS3108K

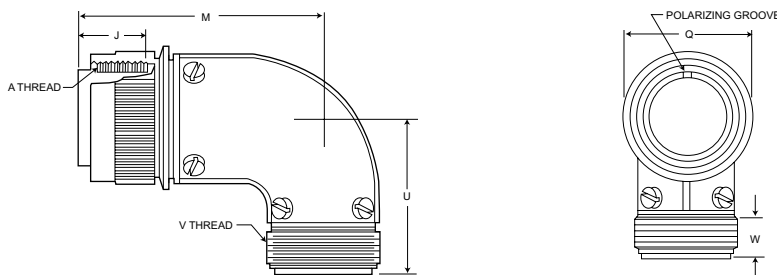

Part Number	A Thread	J	M	Q	U	V Thread	W
MS3108K10SL-†	5/8-24UNEF-2B	.531 (13.49)	1-41/64	31/32	1-21/64	5/8-24UNEF-2A	.375 (9.52)
MS3108K12S-†	3/4-20UNEF-2B	.531 (13.49)	1-41/64	1	1-21/64	5/8-24UNEF-2A	.375 (9.52)
MS3108K14S-†	7/8-20UNEF-2B	.531 (13.49)	1-29/32	1-1/8	1-27/64	3/4-20UNEF-2A	.375 (9.52)
MS3108K16S-†	1-20UNEF-2B	.531 (13.49)	1-29/32	1-1/4	1-27/64	7/8-20UNEF-2A	.375 (9.52)
MS3108K16-†	1-20UNEF-2B	.719 (18.26)	2-3/32	1-1/4	1-27/64	7/8-20UNEF-2A	.375 (9.52)
MS3108K18-†	1-1/8-18UNEF-2B	.719 (18.26)	2-15/64	1-11/32	1-31/64	1-20UNEF-2A	.375 (9.52)
MS3108K20-†	1-1/4-18UNEF-2B	.719 (18.26)	2-19/32	1-15/32	1-21/32	1-3/16-18UNEF-2A	.375 (9.52)
MS3108K22-†	1-3/8-18UNEF-2B	.719 (18.26)	2-19/32	1-19/32	1-21/32	1-3/16-18UNEF-2A	.375 (9.52)
MS3108K24-†	1-1/2-18UNEF-2B	.719 (18.26)	2-49/64	1-23/32	1-63/64	1-7/16-18UNEF-2A	.375 (9.52)
MS3108K28-†	1-3/4-18UNS-2B	.719 (18.26)	2-49/64	1-31/32	1-63/64	1-7/16-18UNEF-2A	.375 (9.52)
MS3108K32-†	2-18UNS-2B	.719 (18.26)	3-1/4	2-7/32	2-7/32	1-3/4-18UNS-2A	.438 (11.13)
MS3108K36-†	2-1/4-16UN-2B	.719 (18.26)	3-1/4	2-15/32	2-9/32	2-18UNS-2A	.500 (12.70)

• Plugs in size 10SL are available with socket inserts only.
* Add contact arrangement. See pages 216-217.

† Add contact type: P - pin; S - socket.

Assembly Instructions

Recommended Procedures

- * 1. Remove Formica retaining ring (or the ceramic retaining ring) from contact (Figure 1).
2. Crimp contact to wire.
3. Slip endbell (or junction shell), retaining ring, and washer over wire bundle.
4. Push contact thru rear insulator. (Contact should extend sufficiently to accomplish Step 5.)
5. Attach Formica retaining ring onto the contact (see Figure 1).
6. Seat each contact securely in rear insulator.
7. Assemble front insulator on engaging end of contact.
8. Slide insulator assembly into hardware.
9. Slide washer and insulator retaining in place, making sure that insulator retaining is fully seated in groove.
10. Slide endbell or junction shell down wire bundle and attach to shell (or barrel).

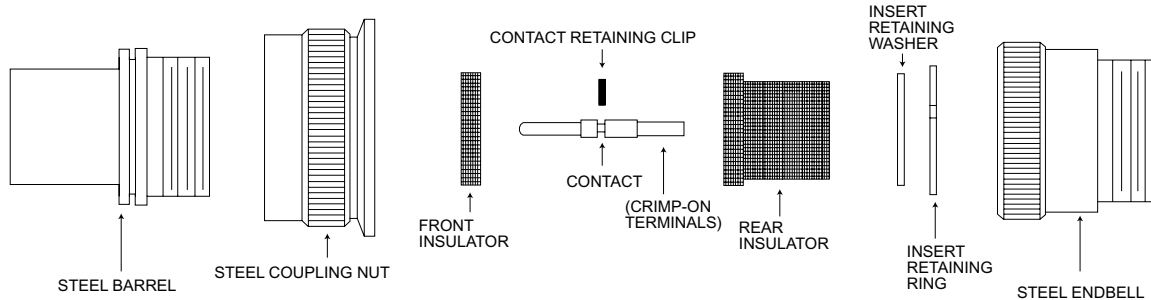

FIGURE 1

*NOTE: For MS-K Assembly it is not necessary to remove the ceramic retaining ring used on sizes 16 and 12 contacts for MS-K **providing** that the crimp tool M22520/1-01 is used with the TH119 turret. However, the formica ring must be removed if using the crimp tools listed below.

When using the MS3191-1 (or CCT-1612) crimp tool with property locator, both the ceramic or formica retaining ring for sizes 16 and 12 contacts must be removed. For sizes 8, 4, and 0 contacts, the ceramic or formica retaining rings must be removed before crimping.

Contacts, Crimp Tools, Contact Kit Part Numbers

MS-K Contacts and Crimp Tools can be ordered separately

Contact Size	Part Number	Wire Accom.	Crimp Tool	Locator	Crimp Head†
16-Pin	330-0187-000	16-18-20	MS22520/1-01	TH119 Turret	-
8S-36			MS3191-1	L16-3191-8	
16 Pin*	030-1154-000	16-18-20	MS22520/1-01	TH119 Turret	-
8S-36			MS3191-1	L16-3191-8	
16 Socket	031-0497-000	16-18-20	MS22520/1-01	TH119 Turret	-
8S-16S			MS3191-1	L16-3191-8	
16 Socket	031-0498-000	16-18-20	MS22520/1-01	TH119 Turret	-
12-36			MS3191-1	L16-3191-7	
16 Socket*	031-0728-000	16-18-20	MS22520/1-01	TH119 Turret	-
12-36			MS3191-1	L16-3191-7	
12 Pin	330-0188-000	12-14	MS22520/1-01	TH119 Turret	-
			MS3191-1	L12-3191-4	
12 Socket	031-0499-000	12-14	MS22520/1-01	TH119 Turret	-
			MS3191-1	L12-3191-4	
8 Pin	330-0189-000	8	CBT600B or CBT600	CCHP8	CCH8-1
8 Socket	031-0500-000	8	CBT600B or CBT600	CCHP8	CCH8-1
4 Pin	330-0190-000	4	CBT600B or CBT600	CCHP4	CCH4-1
4 Socket	031-0501-000	4	CBT600B or CBT600	CCHP4	CCH4-1
0 Pin	330-0191-000	0	CBT600B	CCHP0-6	CCH0-1
0 Socket	031-0502-000	0	CBT600B	CCHP0-6	CCH0-1

MS-K Contacts Assembly Kit With Contact and Retaining Ring

Contact Size	Kit Part Number
16-Pin	320-0002-000
8S-36	
16 Pin*	320-0001-000
8S-36	
16 Socket	320-0013-000
8S-16S	
16 Socket	320-0005-000
12-36	
16 Socket*	320-0008-000
12-36	
12 Pin	320-0009-000
12 Socket	320-0007-000
8 Pin	320-0010-000
8 Socket	320-0014-000
4 Pin	320-0011-000
4 Socket	320-0006-000
0 Pin	320-0012-000
0 Socket	320-0015-000

*These contacts must be used when ordering contact arrangements 24-28 pin or socket, 28-21 pin or socket, and 20-27 socket only.

†Crimp heads are only applicable for contact sizes 8, 4, and 0.

Washing, fuel spillage, and atmospheric variations are responsible for the development of firewall connectors that combine moisture resistance with fireproof characteristics. The CA-KE series provide environmental resistance to meet the moisture problems as well as emergency fire conditions defined by MIL-C-5015. CA-KE connectors are fully interchangeable and intermateable with other 5015 type of connectors. In order to maintain the moisture seal and fire resistance, however, they must mate with corresponding CA-KE connectors.

Continuous operating temperature of +177°C (+350°F) - crimp contacts. Moisture resistant connector for use with sealable wires. Modifications of MS31**K configuration.

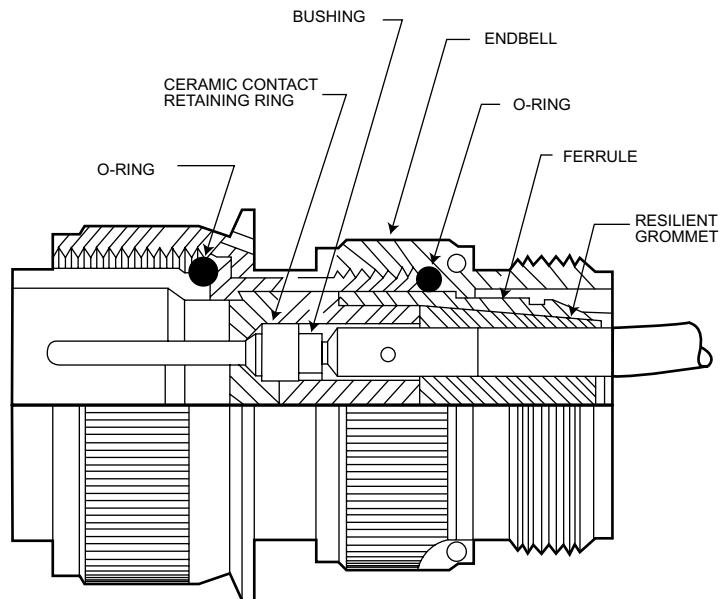

Performance and Material Specifications

MATERIALS

Shell	- Steel
Insulator	- Glass-filled epoxy or glass-filled melamine
Contacts	- Copper alloy
Grommet and O Ring	- Fuel-resistant silicone rubber
Accessory Hardware	- Steel

FINISHES

Shell	- Olive drab over cadmium plate
Contacts	- Silver Plate
Accessory Hardware	- Olive drab over cadmium plate

MECHANICAL FEATURES

Shell Size	- In sixteenths of an inch
Coupling	- Threaded
Contact Arrangements	- See pages 216-217

ELECTRICAL DATA

Number of Contacts	- 1 thru 47
--------------------	-------------

How to Order

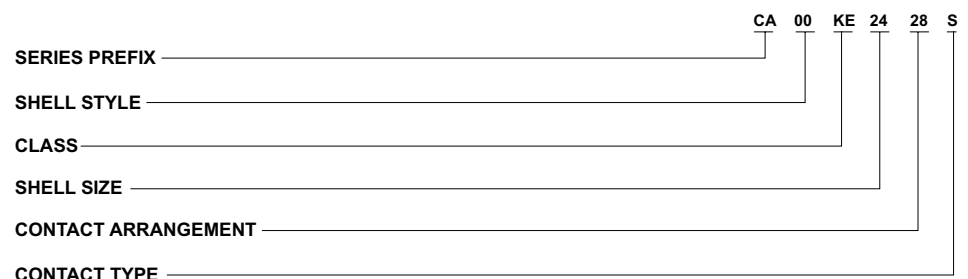

SERIES PREFIX

CA

CLASS

KE - Environment-resistant firewall connector

SHELL STYLE

- 00 - Wall mounting receptacle (without conduit threads)
- 06 - Straight plug (without conduit threads)
- 3100 - Wall mounting receptacle
- 3106 - Straight plug

SHELL SIZE

8S to 36

CONTACT ARRANGEMENT

See pages 216-217.

CONTACT TYPE

P for pin; S for socket

Wall Mounting Receptacle

CA00KE

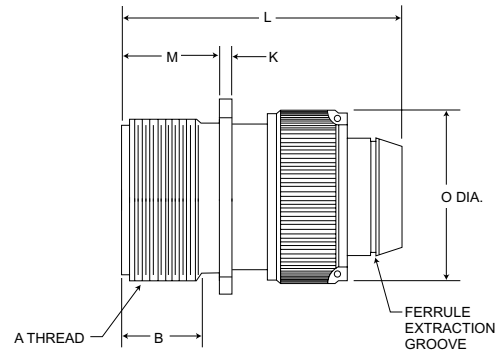
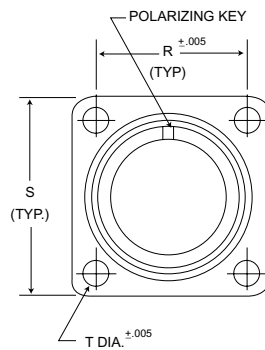

Part Number	A Thread	B	K	L	M	O	R	S	T
CA00KE8S-†	1/2-28UNEF-2A	.375 (9.52)	.063 (1.60)	1.687 (42.85)	.578 (14.68)	.531 (13.49)	5.94 (15.09)	.875 (22.22)	.150 (3.81)
CA00KE10S-†	5/8-24UNEF-2A	.375 (9.52)	.063 (1.60)	1.687 (42.85)	.578 (14.68)	.687 (17.45)	.719 (18.26)	1.000 (25.40)	.150 (3.81)
*CA00KE10S-†	5/8-24UNEF-2A	.375 (9.52)	.063 (1.60)	1.781 (45.24)	.578 (14.68)	.687 (17.45)	.719 (18.26)	1.000 (25.40)	.150 (3.81)
CA00KE12S-†	3/4-20UNEF-2A	.375 (9.52)	.063 (1.60)	1.687 (42.85)	.578 (14.68)	.781 (19.84)	.812 (20.62)	1.094 (27.79)	.150 (3.81)
CA00KE14S-†	7/8-20UNEF-2A	.375 (9.52)	.063 (1.60)	1.687 (42.85)	.578 (14.68)	.906 (23.01)	.906 (23.01)	1.188 (30.18)	.150 (3.81)
CA00KE16S-†	1-20UNEF-2A	.375 (9.52)	.063 (1.60)	1.687 (42.85)	.578 (14.68)	1.031 (26.19)	.969 (24.62)	1.281 (32.54)	.150 (3.81)
CA00KE16-†	1-20UNEF-2A	.625 (15.88)	.078 (1.98)	2.094 (53.19)	.766 (19.46)	1.031 (26.19)	.969 (24.62)	1.281 (32.54)	.150 (3.81)
CA00KE18-†	1-1/8-18UNEF-2A	.625 (15.88)	.078 (1.98)	2.250 (57.15)	.766 (19.46)	1.156 (29.36)	1.062 (26.97)	1.375 (34.92)	.177 (4.50)
CA00KE20-†	1-1/4-18UNEF-2A	.625 (15.88)	.078 (1.98)	2.250 (57.15)	.766 (19.46)	1.344 (34.14)	1.156 (29.36)	1.500 (38.10)	.177 (4.50)
CA00KE22-†	1-3/8-18UNEF-2A	.625 (15.88)	.078 (1.98)	2.250 (57.15)	.828 (21.03)	1.406 (35.71)	1.250 (31.75)	1.625 (41.28)	.177 (4.50)
CA00KE24-†	1-1/2-18UNEF-2A	.625 (15.88)	.078 (1.98)	2.250 (57.15)	.828 (21.03)	1.625 (41.28)	1.375 (34.92)	1.750 (44.45)	.177 (4.50)
CA00KE28-†	1-3/4-18UNS-2A	.625 (15.88)	.078 (1.98)	2.250 (57.15)	.891 (22.63)	1.781 (45.24)	1.562 (39.67)	2.000 (50.80)	.177 (4.50)
CA00KE32-†	2-18UNS-2A	.625 (15.88)	.078 (1.98)	2.250 (57.15)	.891 (22.63)	2.031 (51.59)	1.750 (44.45)	2.250 (57.15)	.209 (5.31)
CA00KE36-†	2-1/4-16UNS-2A	.625 (15.88)	.094 (2.39)	2.250 (57.15)	.891 (22.63)	2.281 (57.94)	1.938 (49.23)	2.500 (63.50)	.209 (5.31)

* Receptacles in size 10SL are available with pin inserts only.

† Add contact type: P - pin; S - socket.

* Add contact arrangement. See pages 216-217.

Straight Plug (Without Conduit Threads)

CA06KE

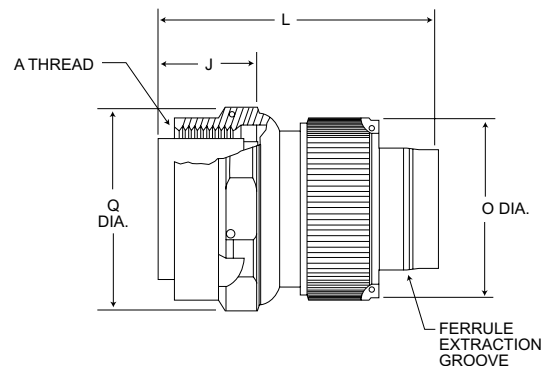
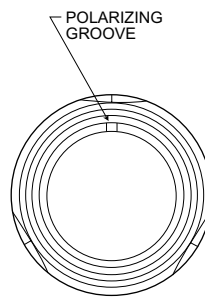

Part Number	A Thread	J	L	O	Q
CA06KE8S-†	1/2-28UNEF-2B	.531 (13.49)	1.687 (42.85)	.531 (13.49)	.828 (21.03)
CA06KE10S-†	5/8-24UNEF-2B	.531 (13.49)	1.687 (42.85)	.687 (17.45)	.969 (24.62)
*CA06KE10S-†	5/8-24UNEF-2B	.531 (13.49)	1.687 (42.85)	.781 (19.84)	.969 (24.62)
CA06KE12S-†	3/4-20UNEF-2B	.531 (13.49)	1.687 (42.85)	.781 (19.84)	1.047 (26.59)
CA06KE14S-†	7/8-20UNEF-2B	.531 (13.49)	1.687 (42.85)	.906 (23.01)	1.125 (28.58)
CA06KE16S-†	1-20UNEF-2B	.531 (13.49)	1.687 (42.85)	1.031 (26.19)	1.250 (31.75)
CA06KE16-†	1-20UNEF-2B	.719 (18.26)	2.094 (53.19)	1.031 (26.19)	1.250 (31.75)
CA06KE18-†	1-1/8-18UNEF-2B	.719 (18.26)	2.250 (57.15)	1.156 (29.36)	1.344 (34.14)
CA06KE20-†	1-1/4-18UNEF-2B	.719 (18.26)	2.250 (57.15)	1.344 (34.14)	1.484 (37.69)
CA06KE22-†	1-3/8-18UNEF-2B	.719 (18.26)	2.250 (57.15)	1.406 (35.71)	1.609 (40.87)
CA06KE24-†	1-1/2-18UNEF-2B	.719 (18.26)	2.250 (57.15)	1.625 (41.28)	1.734 (44.04)
CA06KE28-†	1-3/4-18UNS-2B	.719 (18.26)	2.250 (57.15)	1.781 (45.24)	1.984 (50.39)
CA06KE32-†	2-18UNS-2B	.719 (18.26)	2.250 (57.15)	2.031 (51.59)	2.234 (56.74)
CA06KE36-†	2-1/4-16UNS-2B	.719 (18.26)	2.250 (57.15)	2.281 (57.94)	2.484 (63.09)

* Plugs in size 10SL are available with socket inserts only.

† Add contact type: P - pin; S - socket.

* Add contact arrangement. See pages 216-217.

NOTE: Coupling nut has hex configuration on sizes 8S, 10S, 10SL, 12 and 24; knurled configuration on all others.

Wall Mounting Receptacle

CA3100KE

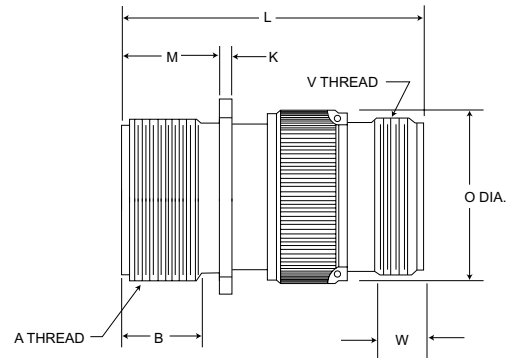
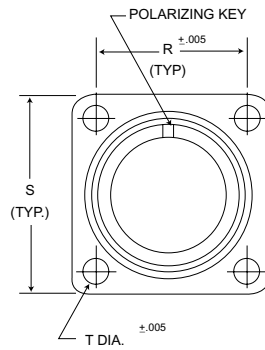

Part Number	A Thread	B	K	L	M	O	R	S	T	V Thread	W
CA3100KE8S-††	1/2-28UNEF-2A	.375 (9.52)	.063 (1.60)	2.000 (50.80)	.578 (14.68)	.531 (13.49)	.594 (15.09)	.875 (22.22)	.150 (3.81)	1/2-28UNEF-2A	.375 (9.52)
CA3100KE10S-††	5/8-24UNEF-2A	.375 (9.52)	.063 (1.60)	2.000 (50.80)	.578 (14.68)	.687 (17.45)	.719 (18.26)	1.000 (25.40)	.150 (3.81)	1/2-24UNEF-2A	.375 (9.52)
• CA3100KE10SI-††	5/8-24UNEF-2A	.375 (9.52)	.063 (1.60)	2.000 (50.80)	.578 (14.68)	.781 (19.84)	.719 (18.26)	1.000 (25.40)	.150 (3.81)	5/8-24UNEF-2A	.375 (9.52)
CA3100KE12S-††	3/4-20UNEF-2A	.375 (9.52)	.063 (1.60)	2.000 (50.80)	.578 (14.68)	.781 (19.84)	.812 (20.62)	1.094 (27.79)	.150 (3.81)	5/8-20UNEF-2A	.375 (9.52)
CA3100KE14S-††	7/8-20UNEF-2A	.375 (9.52)	.063 (1.60)	2.000 (50.80)	.578 (14.68)	.906 (23.01)	.906 (23.01)	1.188 (30.18)	.150 (3.81)	3/4-20UNEF-2A	.375 (9.52)
CA3100KE16S-††	1-20UNEF-2A	.375 (9.52)	.063 (1.60)	2.000 (50.80)	.578 (14.68)	1.031 (26.19)	.969 (24.62)	1.281 (32.54)	.150 (3.81)	7/8-20UNEF-2A	.375 (9.52)
CA3100KE16-††	1-20UNEF-2A	.625 (15.88)	.078 (1.98)	2.188 (55.58)	.766 (19.46)	1.031 (26.19)	.969 (24.62)	1.281 (32.54)	.150 (3.81)	7/8-20UNEF-2A	.375 (9.52)
CA3100KE18-††	1-1/8-18UNEF-2A	.625 (15.88)	.078 (1.98)	2.250 (57.15)	.766 (19.46)	1.156 (29.36)	1.062 (26.97)	1.375 (34.92)	.177 (4.50)	1-20UNEF-2A	.375 (9.52)
CA3100KE20-††	1-1/4-18UNEF-2A	.625 (15.88)	.078 (1.98)	2.313 (58.75)	.766 (19.46)	1.344 (34.14)	1.156 (29.36)	1.500 (38.10)	.177 (4.50)	1-3/16-18UNEF-2A	.375 (9.52)
CA3100KE22-††	1-3/8-18UNEF-2A	.625 (15.88)	.078 (1.98)	2.313 (58.75)	.828 (21.03)	1.406 (35.71)	1.250 (31.75)	1.625 (41.28)	.177 (4.50)	1-3/16-18UNEF-2A	.375 (9.52)
CA3100KE24-††	1-1/2-18UNEF-2A	.625 (15.88)	.078 (1.98)	2.313 (58.75)	.828 (21.03)	1.625 (41.28)	1.375 (34.92)	1.750 (44.45)	.177 (4.50)	1-7/16-18UNEF-2A	.375 (9.52)
CA3100KE28-††	1-3/4-18UNS-2A	.625 (15.88)	.078 (1.98)	2.688 (68.28)	.891 (22.63)	1.781 (45.24)	1.562 (39.67)	2.000 (50.80)	.177 (4.50)	1-7/16-18UNS-2A	.375 (9.52)
CA3100KE32-††	2-18UNS-2A	.625 (15.88)	.078 (1.98)	2.375 (60.32)	.891 (22.63)	2.031 (51.59)	1.750 (44.45)	2.250 (57.15)	.209 (5.31)	1-3/4-18UNS-2A	.437 (11.10)
CA3100KE36-††	2-1/4-16UN-2A	.625 (15.88)	.094 (2.39)	2.438 (61.93)	.891 (22.63)	2.281 (57.94)	1.938 (49.23)	2.500 (63.50)	.209 (5.31)	2-18UNS-2A	.500 (12.70)

• Receptacles in size 10SL are available with pin inserts only.

† Add contact type: P - pin; S - socket.

* Add contact arrangements. See pages 216-217.

Straight Plug

CA3106KE

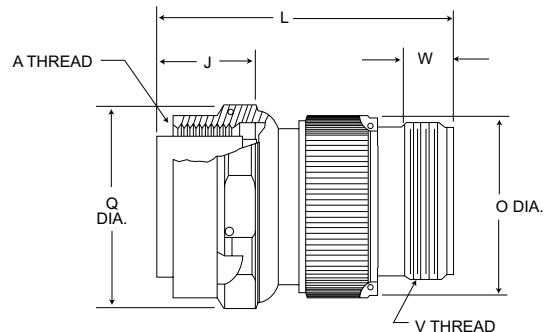
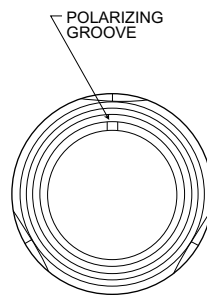

Part Number	A Thread	J	L	O	Q	V Thread	W
CA3106KE8S-††	1/2-28UNEF-2B	.531 (13.49)	2.000 (50.80)	.531 (13.49)	.828 (21.03)	1/2-28UNEF-2A	.375 (9.52)
CA3106KE10S-††	5/8-24UNEF-2B	.531 (13.49)	2.000 (50.80)	.687 (17.45)	.969 (24.62)	1/2-24UNEF-2A	.375 (9.52)
• CA3106KE10SI-††	5/8-24UNEF-2B	.531 (13.49)	2.000 (50.80)	.781 (19.84)	.969 (24.62)	5/8-24UNEF-2A	.375 (9.52)
CA3106KE12S-††	3/4-20UNEF-2B	.531 (13.49)	2.000 (50.80)	.781 (19.84)	1.047 (26.59)	5/8-20UNEF-2A	.375 (9.52)
CA3106KE14S-††	7/8-20UNEF-2B	.531 (13.49)	2.000 (50.80)	.906 (23.01)	1.125 (28.58)	3/4-20UNEF-2A	.375 (9.52)
CA3106KE16S-††	1-20UNEF-2B	.531 (13.49)	2.000 (50.80)	1.031 (26.19)	1.250 (31.75)	7/8-20UNEF-2A	.375 (9.52)
CA3106KE16-††	1-20UNEF-2B	.719 (18.26)	2.188 (55.58)	1.031 (26.19)	1.250 (31.75)	7/8-20UNEF-2A	.375 (9.52)
CA3106KE18-††	1-1/8-18UNEF-2B	.719 (18.26)	2.250 (57.15)	1.156 (29.36)	1.344 (34.14)	1-20UNEF-2A	.375 (9.52)
CA3106KE20-††	1-1/4-18UNEF-2B	.719 (18.26)	2.313 (58.75)	1.344 (34.14)	1.484 (37.69)	1-3/16-18UNEF-2A	.375 (9.52)
CA3106KE22-††	1-3/8-18UNEF-2B	.719 (18.26)	2.313 (58.75)	1.406 (35.71)	1.609 (40.87)	1-3/16-18UNEF-2A	.375 (9.52)
CA3106KE24-††	1-1/2-18UNEF-2B	.719 (18.26)	2.313 (58.75)	1.625 (41.28)	1.734 (44.04)	1-7/16-18UNEF-2A	.375 (9.52)
CA3106KE28-††	1-3/4-18UNS-2B	.719 (18.26)	2.688 (68.28)	1.781 (45.24)	1.984 (50.39)	1-7/16-18UNS-2A	.375 (9.52)
CA3106KE32-††	2-18UNS-2B	.719 (18.26)	2.375 (60.32)	2.031 (51.59)	2.234 (56.74)	1-3/4-18UNS-2A	.437 (11.10)
CA3106KE36-††	2-1/4-16UNS-2B	.719 (18.26)	2.438 (61.93)	2.81 (57.94)	2.484 (63.09)	2-18UNS-2A	.500 (12.70)

• Plugs in size 10SL are available with socket inserts only.

† Add contact type: P - pin; S - socket.

* Add contact arrangement. See pages 216-217.

NOTE: Coupling nut has hex configuration on sizes 8S, 10S, 10SL, 12 and 24; knurled configuration on all others.

Assembly Instructions

- Disassemble the connector. See Figure 1 for component parts relationship for reassembly after wiring.
- Remove ceramic retaining ring from contact by sliding the retaining ring back, compressing the bushing until the ring can be slipped away from the contact (see Figure 2).
- Crimp pin or socket contact to wire.
- Slip endbell or ferrule retaining nut (whichever is used) over wire bundle (see Figure 3).
- Slip ferrule over wire bundle (see Figure 3).
- Push contact (pin or socket) thru rear of grommet and rear insulator. (Note that the contact is inserted into the end of the grommet that shows the layout identification.) Contact should extend sufficiently to accomplish Step 7.
- After the wired contacts have been inserted thru the rear insulator and grommet, install the ceramic contact retaining ring (Figure 2). Slip on the small diameter of the contact (diameter B). Push the ceramic ring up and onto the larger diameter of the contact (diameter A). The ceramic ring should then be in place. The rubber bushing (which is already on the contact) compresses to allow this assembly, and also keeps the ceramic ring in place after assembly.
- Seat each contact individually in rear insulator (see Figure 4), Pulling rear insulator so it is tight against the grommet.
- Assemble front insulator onto engaging end of contacts.
- Slide ferrule down wire bundle over grommet, making sure that grommet is lubricated per assembly drawing (see Figure 4).
- Insert this assembly into shell or barrel (whichever is applicable) being careful to polarize correctly.
- Slide endbell or ferrule retaining nut down wire bundle and screw onto shell/barrel. When properly assembled the layout identification will be visible.

Fig. 1

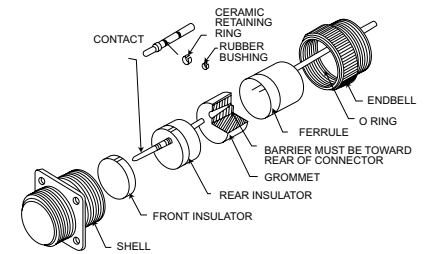

Fig. 2

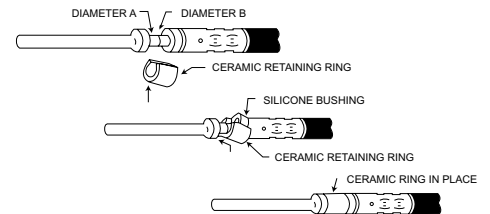

Fig. 3

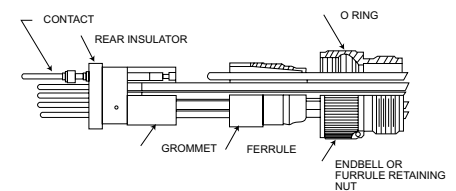
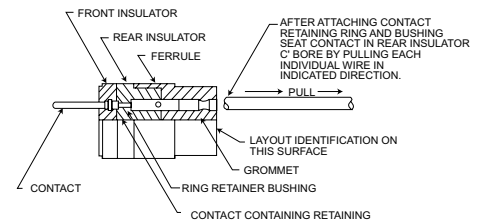

Fig. 4



***NOTE: For CA-KE Assembly** it is not necessary to remove the ceramic retaining ring used on size 16 and 12 contacts for CA-KE providing that the crimp tool M22520/1-01 is used with the TH118 turret. However, the formica ring must be removed if using the crimp tools.

When using the MS3191-1 (or CCT-1612) crimp tool with property locator, both the ceramic or formica retaining ring for sizes 16 and 12 contacts must be removed. For sizes 8, 4, and 0 contacts, the ceramic or formica retaining rings must be removed before crimping.

Contacts, Crimp Tools, Contact Part Numbers

Contacts and Crimp Tools						Contact Assembly Kit With Retaining Ring and Bushing	
Contact Size	Part Number	Wire Accom.	Crimp Tool	Locator	Crimp Head*	Contact Size	Kit Part Number
16 Pin/8S-16S	030-1133-000	16-18-20	M22520/1-01 or MS3191-1	TH118 Turret/L16-3191-2	-	16 Pin/8S-16S	038586-0000
16 Pin/12-36	030-1082-000	16-18-20	M22520/1-01 or MS3191-1	TH118 Turret/L16-3191-9	-	16 Pin/12-36	038588-0000
16 Socket/8S-16S	031-0731-000	16-18-20	M22520/1-01 or MS3191-1	TH118 Turret/L16-3191-2	-	16 Socket/8S-16S	038587-0000
16 Socket/12-36	031-0706-000	16-18-20	M22520/1-01 or MS3191-1	TH118 Turret/L16-3191-11	-	16 Socket/12-36	038589-0000
12 Pin	030-1134-000	12-14	M22520/1-01 or MS3191-1	TH118 Turret/L12-3191-5	-	12 Pin	038590-0000
12 Socket	031-0732-000	12-14	M22520/1-01 or MS3191-1	TH118 Turret/L12-3191-1	-	12 Socket	038591-0000
8 Pin	030-1135-000	8	CBT600B or CBT600	CCHP8-7	CCH8-1	8 Pin	038592-0000
8 Socket	031-0733-000	8	CBT600B or CBT600	CCHP8-7	CCH8-1	8 Socket	038593-0000
4 Pin	030-1212-000	4	CBT600B or CBT600	CCHP4-7	CCH4-1	4 Pin	038594-0000
4 Socket	031-0770-000	4	CBT600B or CBT600	CCHP4-7	CCH4-1	4 Socket	038595-0000
0 Pin	030-1734-000	0	6BT600B	CCHP0-7	CCH0-1	0 Pin	031-1176-000
0 Socket	031-0975-000	0	6BT600B	CCHP0-7	CCH0-1	0 Socket	031-1177-000

* Crimp heads are applicable for contact sizes 8, 4, and 0.



FRF/FVF Fire wall connectors are designed to meet the requirements of MIL-C-5015 and prevent the passage of +1093°C (+2000°F) flames for 20 minutes. They incorporate the latest sophisticated design improvements necessary to meet the exacting demands of supersonic flight applications. Some of these features are temperature capabilities to +204°C (+392°F) for more than 1000 hours, lighter weight, small than other MIL-C-5015 firewall connectors, and crimp front release contacts.

Firewall connectors fulfill the very important application of providing a means to penetrate the engine firewall of military and commercial aircraft with

electrical circuits, and still maintain the integrity of the flame barrier requirements of the aircraft firewall. These connectors provide protection against high temperatures, emergency fire-retardant conditions, moisture, atmospheric changes, and are resistant to fuels, cleaning agents, coolants, and hydraulic fluids. Materials of connector arrangements are designed to meet the requirements of MIL-C-5015 Class K connectors.

The maximum operating temperature noted for these connectors is the maximum internal hot spot resulting from any combination of electrical load and ambient conditions.

How to Order

FRF 6 E 12S 3 P X -01
 FVF 0 A 12S 3 S X
 FRA 0 - 12S 3 P
 FVA 6 - 12S 3 S FO



SERIES PREFIX

- FRF - Fluorosilicone elastomers, steel hardware with clear chromate (A105) finish
- FVF - Silicone elastomers, steel hardware with clear chromate (A105) finish
- FRA - Same as FRF except aluminum hardware
- FVA - Same as FVF except aluminum hardware

SHELL STYLE

- 6 - Plug
- 0 - Receptacle, flange mounting

ACCESSORY HARDWARE (ALUMINUM)

- E (FRF/FRA) - Endbell with cable clamp
- E (FVF/FVA) - Endbell with cable clamp with ferrules
- A (FRF/FRA) - Endbell adapter threaded for conduit
- A (FVF/FVA) - Endbell adapter threaded for conduit with ferrules
- Use dash (-) for connectors less accessories (Dash must be included in description)

SHELL SIZE

- 10SL, 12S, 14S, 16S, 16, 18, 20, 22, 24, 28, 32 and 36

CONTACT ARRANGEMENT

See pages 216-217

CONTACT ARRANGEMENT

P for pin; S for socket

INSERT POLARIZATION

W, X, Y or Z in accordance with MIL-C-5015. No designator required for normal

LESS CONTACT

FO - (Will not be stamped on connectors)

MODIFIERS

- 01 - Ball, self-locking knurled coupling nut (see note 1 below)
- 02 - Size 16 contacts to accommodate size 20 wire
- 03 - Clinch nut mounting receptacles (F28)
- 04 - Obsolete
- 05 - Knurled coupling nut
- 06 - Combination 01 and 02 codes
- 07 - Ferrules only (see note 4 below)
- 08 - Combination 01 and 07 codes (see note 4 below)
- 09 - Combination 05 and 07 codes (see note 4 below)
- 10 - Anchor nut plates on receptacle shells
- 11 - MS3057 type "A" endbell clamp, less bushing

MODIFIERS (continued)

- 12 - Combination 07 and 10 codes
- 13 - 01 code, with safety wire holes on coupling nut
- 14 - 90° endbell (with saddle clamp and ferrule)
- 15 - Combination 01 and 14 codes
- 16 - 03 code plus ferrules (code 07)
- 17 - Obsolete
- 18 - 01 code and steel conduit adapter
- 19 - FRFO/FVFO receptacle with steel conduit adapter
- A72 - Black chromate finish (by customer request)

NOTES

1. Modifier 01: Used for high vibration/shock applications
2. Less Contacts: Use the Modifier "-FO" or "L". The modifier will not be stamped on the connector. Modifier "-FO" is preferred.
3. Numerical FRA/FRF modifiers are assigned consecutively as needed and there is no significance to numerical order.
4. The basic FRA and FRF connectors were designed for use without ferrules. Ferrules are suggested when undersized wire is used so that the grommet seals will not spread apart (i.e. opened) when the wires are flexed as the wire maybe too stiff for its bend to be completely damped out by the endbell cable clamp.

Design Features

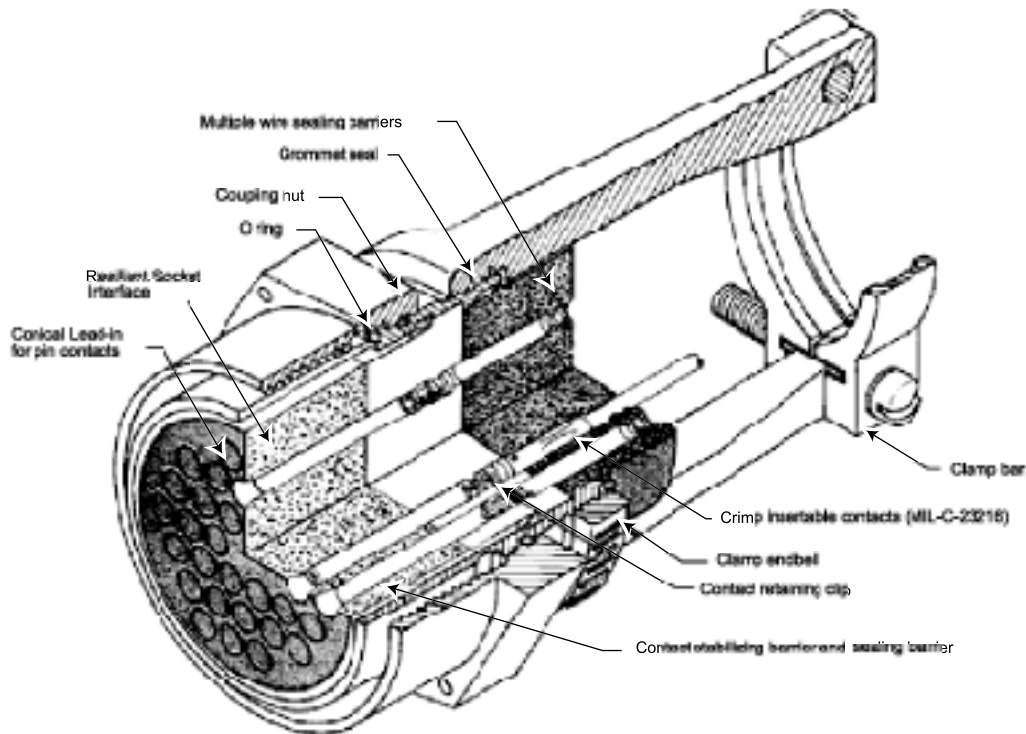

Complete Moisture Sealing

An improved shell-to-barrel O ring seals against pressure differential to 15 psi before and after exposure to +204°C (+392°F).

Positive interfacial sealing is accomplished with a pin and socket interlocking barrier design.

A highly reliable grommet sealing system incorporates multiple wire sealing barriers and a grommet-to-shell seal.

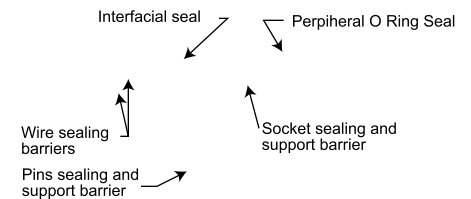

Rugged Metal Clip Retention System

These clips are one-piece metal parts with slotted, inwardly deflected tines assuring positive contact retention. They are retained and positively located in the hard insulator contact cavities by a molded-in shoulder providing strength where the greatest load from mating and unmating occurs.

Contacts are seated on the clip shoulder, and the contact retaining clip locks on the taper retention undercut of the contact.

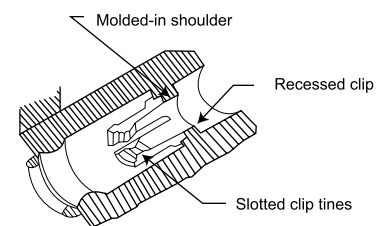

Improved Contact Alignment and Stability

The large lead-in chamfer on the semi-resilient insert provides positive contact alignment by "guiding" the tip of the pin contact into the mating socket. This chamfer provides maximum contact centering without restricting contact float or tool insertion.

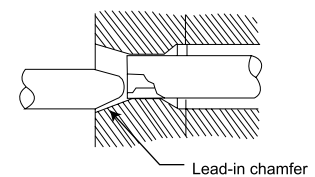

Optional Self-Locking Coupling Nut

The mechanism employs a spring-loaded detent system that is free running until near full engagement. At this point torque valves increase causing the mechanism to produce an audible clicking until full engagement. The mechanism is effective even when coupling stops at a position between detents.

When full mating is achieved, a color appears in the indicator window on the periphery of the coupling nut. The indicator is serrated so that full mating can be determined in a blind installation by feel, with a probe approximately .0312 (0.79) diameter.

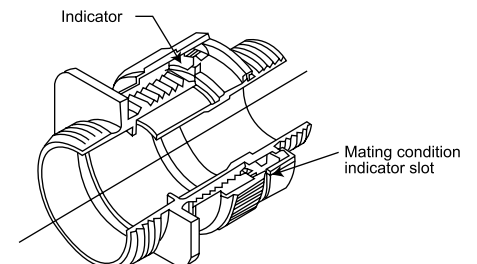

Performance and Material Specifications

ELECTRICAL DATA

Contact Size	Wire Size	Insulation OD Limit	
	(MIL-W-5086)	min.	max.
16	16 thru 20	.068 (1.73)	.135 (3.43)
12	12 thru 14	.092 (2.34)	.200 (5.08)
8	8 thru 10	.132 (3.35)	.300 (7.62)
4	4 thru 6	.227 (5.77)	.425 (10.80)
0	0 thru 2	.390 (9.91)	.590 (14.99)

MATERIALS AND FINISHES

Shell - Machined cadmium plated steel (FRF/FVF)
 - Aluminum (FRA/FVA)

Insulator - Glass filled epoxy

Grommets and Interfacial Seals-FRF-Flourosilicone/FVF-Silicone

Contacts† - Copper alloy, gold plating per MIL-C-39029

Clip - Copper alloy

MECHANICAL FEATURES

Coupling - Threaded

Polarization - Single keyway per MIL-C-5015

Contact Retention - Metal Clip

Test Data (FRF and FVF Only)

Moisture Resistance - Exceed MIL-STD-202E, Method 106D

Fire Test - Exceeds MIL-C-5051G, Para. 4.6.16

Fluid Emersion - Per MIL-C-5015G, Para. 4.6.15.3

Fluid	Use	Fluid	Use
JP-4	Aviation fuel	Navee 427	Alkaline cleaner
Kerosene	Aviation fuel	MIL-L-23699	Turbine lube oil
MIL-H-5606	Hydraulic fluid	Skydrol 500A	Hydraulic fluid
Ethylene Glycol	Synthetic coolant	MIL-L-7808D	Turbine lube oil
Cee-Bee A-693	Alkaline cleaner	Texaco 6256	Turbine lube oil

Contacts

Pin and Socket

Pin and socket contacts are machined from bar stock to assure precision operation. They are designed to resist severe vibration and repeated connection and disconnection. The average force to either engage or separate pin and socket contacts will not exceed the average values given in the latest revision of MIL-C-39029.

Force in oz.	Contact Sizes				
	16	12	8	4	0
Maximum	30	30	160	240	320
Average	24	24	7	10.5	15
Minimum	2	3	5	10	14

Thermocouple Contacts

Size 12 and 16 contacts, machined from matching thermocouple lead wire alloys, can be supplied in ITT Cannon connectors. These thermocouple contacts maintain continuity from thermal-sensor leads through a bulkhead or other closures in temperature measuring applications.

These contacts for matching lead wires are detailed by the standards of the Instrument Society of America (I.S.A.).

I.S.A. Standards	Material
J	Iron and constantan
K	Chromel and alumel
T	Copper and constantan

Service Data

Maximum current ratings of contacts and maximum allowable voltage drop under test conditions when assembled as in service are shown. Maximum total current to be carried per connector is the same as that allowable in wire bundles as specified in MIL-W-5088.

Current Rating with Silver Plated Wire

Contact Size	Test Current (amps)	Potential Drop (millivolts)
16	13	49
12	23	42
8	46	26
4	80	23
0	150	21

High Potential Test Data

These connectors show no evidence of breakdown when the test voltage indicated is applied between the two closest contacts and between the shell and the contacts closest to the shell for a period of one minute.

MS Service Rating	TEST Voltage (RMS) 60 cps	Operating Voltages Suggested		Air Spacing nom. inches	Creepage Distance nom. inches
		DC	AC (rms)		
Inst.	1000	250	200	-	1/16
A	2000	700	500	1/16	1/8
D	2800	1250	900	1/8	3/16
E	3500	1750	1250	3/16	1/4
B	4500	2450	1750	1/4	5/16
C	7000	4200	3000	5/16	1

Wall Mounting Receptacle

FRF0/FVF0

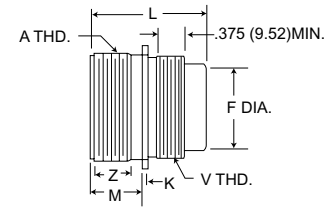
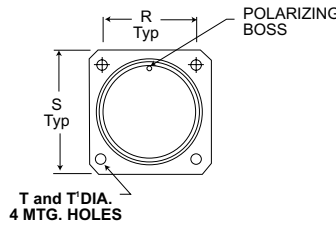

(T' is FRA/FVA dim. only)

Shell Size	A Thread	L Max.			F Max.	K Max.	M +.031 - .000	R ±.005	S Max.	T +.010 - .005	T' +.010 - .005	V Thread	Z Min.
		#16 #12	#8 #4	#0									
10SL	5/8-24UNEF-2A	1.685 (42.80)*	-	-	.455 (11.30)	.098 (2.49)	.562 (14.27)	.719 (18.26)	1.031 (26.19)	.150 (3.81)	.120 (3.04)	5/8-24UNEF-2A	.375 (9.52)
12S	3/4-20UNEF-2A	1.875 (47.62)	-	-	.445 (11.30)	.098 (2.49)	.562 (14.27)	.812 (20.62)	1.125 (28.58)	.150 (3.81)	.120 (3.04)	5/8-24UNEF-2A	.375 (9.52)
14S	7/8-20UNEF-2A	1.875 (47.62)	-	-	.522 (13.26)	.098 (2.49)	.562 (14.27)	.906 (23.01)	1.219 (30.96)	.150 (3.81)	.120 (3.04)	3/4-20UNEF-2A	.375 (9.52)
16S	1-20UNEF-2A	1.875 (47.62)	-	-	.647 (16.43)	.098 (2.49)	.562 (14.27)	.969 (24.61)	1.312 (33.32)	.150 (3.81)	.120 (3.04)	7/8-20UNEF-2A	.375 (9.52)
16	1-20UNEF-2A	1.922 (48.82)	2.141 (54.38)	-	.647 (16.43)	.098 (2.49)	.750 (19.05)	.969 (24.61)	1.312 (33.32)	.150 (3.81)	.120 (3.04)	7/8-20UNEF-2A	.625 (15.86)
20	1-1/4-18UNEF-2A	1.922 (48.82)	2.141 (54.38)	2.422 (61.52)	.921 (23.39)	.140 (3.56)	.750 (19.05)	1.156 (29.36)	1.531 (38.89)	.177 (4.50)	.120 (3.04)	1-1/4-18UNEF-2A	.625 (15.86)
22	1-3/8-UNEF-2A	1.922 (48.82)	2.141 (54.38)	2.422 (61.52)	1.016 (25.81)	.140 (3.56)	.750 (19.05)	1.250 (31.75)	1.656 (42.06)	.177 (4.50)	.120 (3.04)	1-1/4-18UNEF-2A	.625 (15.86)
24	1-1/2-18UNEF-2A	1.922 (48.82)	2.141 (54.38)	2.422 (61.52)	1.141 (28.98)	.140 (3.56)	.812 (20.62)	1.375 (34.92)	1.781 (45.24)	.177 (4.50)	.147 (3.73)	1-3/8-18UNEF-2A	.625 (15.86)
28	1-3/4-18UNS-2A	1.922 (48.82)	2.141 (54.38)	2.422 (61.52)	1.361 (34.57)	.140 (3.56)	.812 (20.62)	1.562 (39.67)	2.031 (51.59)	.177 (4.50)	.147 (3.73)	1-5/8-18UNEF-2A	.625 (15.86)
32	2-18UNS-2A	1.922 (48.82)	2.141 (54.38)	2.422 (61.52)	1.611 (40.92)	.140 (3.56)	.875 (22.22)	1.750 (44.45)	2.281 (57.94)	.290 (5.31)	.173 (4.39)	1-7/8-16UN-2A	.625 (15.86)
36	2-1/4-16UN-2A	1.922 (48.82)	2.141 (54.38)	2.422 (61.52)	1.826 (46.38)	.140 (3.56)	.875 (22.22)	1.938 (49.23)	2.531 (64.29)	.209 (5.31)	.173 (4.39)	2-1/8-16UN-2A	.625 (15.86)

*Available with pin inserts only.

Straight Plug

FRF6/FVF6

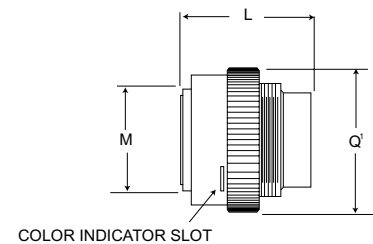
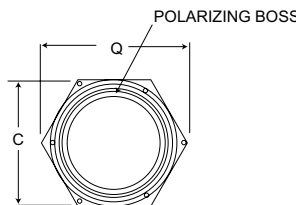
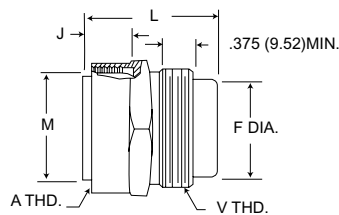

Shell Size	A Thread	L Max.			C Hex.	F Max.	J Max.	M Max.	Q Max.	Q' Max.	V Thread
		#16 #12	#8 #4	#0							
10SL	5/8-24UNEF-2B	1.819 (46.20)	-	-	.812 (20.62)	.455 (11.30)	.564 (14.33)	.446 (11.33)	.950 (24.13)	.970 (24.64)	5/8-24UNEF-2A
12S	3/4-20UNEF-2B	1.875 (47.62)	-	-	.937 (23.80)	.445 (11.30)	.564 (14.33)	.555 (14.10)	1.094 (27.79)	1.092 (27.74)	5/8-24UNEF-2A
14S	7/8-20UNEF-2B	1.875 (47.62)	-	-	1.000 (25.40)	.522 (13.26)	.264 (14.33)	.675 (17.14)	1.167 (29.64)	1.240 (31.50)	3/4-20UNEF-2A
16S	1-20UNEF-2B	1.875 (47.62)	-	-	1.125 (28.58)	.647 (16.43)	.564 (14.33)	.805 (20.45)	1.311 (33.30)	1.386 (35.20)	7/8-20UNEF-2A
16	1-20UNEF-2B	1.922 (48.82)	2.141 (54.38)	-	1.125 (28.58)	.647 (16.43)	.754 (19.15)	.805 (20.45)	1.311 (33.30)	1.386 (35.20)	7/8-20UNEF-2A
20	1-1/4-18UNEF-2B	1.922 (48.82)	2.141 (54.38)	2.422 (61.52)	1.375 (34.92)	.921 (23.39)	.754 (19.15)	1.050 (26.67)	1.600 (40.64)	1.650 (41.91)	1-1/4-18UNEF-2A
22	1-3/8-UNEF-2B	1.922 (48.82)	2.141 (54.38)	2.422 (61.52)	1.500 (38.10)	1.016 (25.81)	.754 (19.15)	1.175 (29.84)	1.744 (44.30)	1.745 (44.32)	1-1/4-18UNEF-2A
24	1-1/2-18UNEF-2B	1.922 (48.82)	2.141 (54.38)	2.422 (61.52)	1.625 (41.28)	1.141 (28.98)	.754 (19.15)	1.300 (33.02)	1.833 (46.56)	1.962 (49.83)	1-3/8-18UNEF-2A
28	1-3/4-18UNS-2B	1.922 (48.82)	2.141 (54.38)	2.422 (61.52)	1.875 (47.62)	1.361 (34.57)	.754 (19.15)	1.520 (38.61)	2.177 (55.30)	2.125 (53.98)	1-5/8-18UNEF-2A
32	2-18UNS-2B	1.922 (48.82)	2.141 (54.38)	2.422 (61.52)	2.125 (43.96)	1.611 (40.92)	.754 (19.15)	1.770 (44.96)	2.466 (62.64)	2.385 (60.58)	1-7/8-16UN-2A
36	2-1/4-16UN-2B	1.922 (48.82)	2.141 (54.38)	2.422 (61.52)	2.375 (60.33)	1.826 (46.38)	.754 (19.15)	1.980 (50.29)	2.754 (69.95)	2.585 (65.66)	2-1/8-16UN-2A

*Available with socket inserts only.

Accessory Hardware

FRF0/FVF0

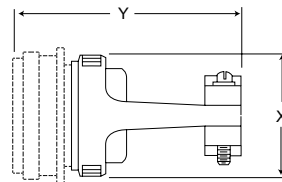
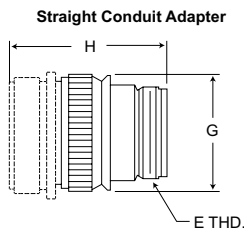

Straight Cable Clamp

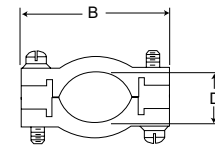

FRF6/FVF6

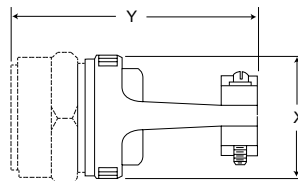
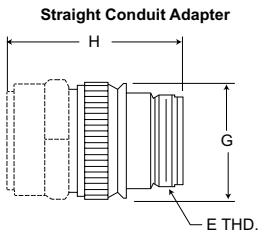

Straight Cable Clamp

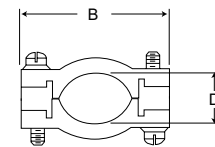

Shell Size	E Thread	B Max.	D Min.	H G Max.	Max. #16,#0	X Max.	Y Max.
10SL	5/8-24UNEF-2A	1.00 (25.40)	.312 (7.92)	.883 (22.43)	2.350 (59.69)	.953 (24.21)	2.940 (74.68)
12S	5/8-24UNEF-2A	1.00 (25.40)	.312 (7.92)	.883 (22.43)	2.350 (59.69)	.953 (24.21)	2.940 (74.68)
14S	3/4-20UNEF-2A	1.190 (30.23)	.438 (11.12)	1.003 (25.48)	2.350 (59.69)	1.078 (27.38)	3.090 (78.49)
16S	7/8-20UNEF-2A	1.280 (35.51)	.561 (14.25)	1.133 (28.78)	2.350 (59.69)	1.203 (30.56)	3.410 (86.61)
16	7/8-20UNEF-2A	1.280 (32.51)	.561 (14.25)	1.133 (28.78)	2.500 (63.50)	1.203 (30.56)	3.560 (90.42)
20	1-3/16-18UNEF-2A	1.530 (38.86)	.750 (19.05)	1.430 (36.32)	3.000 (76.20)	1.453 (36.91)	3.560 (90.42)
22	1-3/16-18UNEF-2A	1.630 (41.40)	.750 (19.05)	1.497 (38.02)	3.260 (82.80)	1.578 (40.08)	3.560 (90.42)
24	1-7/16-18UNEF-2A	1.775 (45.08)	.937 (23.80)	1.573 (39.95)	3.260 (82.80)	1.703 (43.26)	3.900 (99.06)
28	1-7/16-18UNEF-2A	2.025 (51.44)	1.187 (30.15)	1.792 (45.52)	3.260 (82.80)	1.953 (49.61)	3.900 (99.06)
32	1-3/4-18UNS-2A	2.265 (57.53)	1.250 (31.75)	2.121 (53.87)	3.260 (82.80)	2.203 (55.96)	4.400 (111.76)
36	2-18UNS-2A	2.525 (64.14)	1.375 (34.92)	2.308 (58.62)	3.300 (83.82)	2.453 (62.31)	4.650 (118.11)

Tooling



Contact Size	Crimp Tool	Crimp Head	Locator Number	Insertion Tool	Extraction Tool
16	M22520/1-01	M22520/1-02		MS90455-16 or MIL-I-81969/17-01	CET-FRF-16-22A
12				MS90455-12 or MIL-I-81960/17-02	CET-FRF-12
8	CBT-600B	CCH-8-1	CCHP-8-6	Not Req'd	CET-FRF-8
4	CBT-600B	CCH-4-1	CCHP-4-8	Not Req'd	CEF-FRF-4
0	CBT-600B	CCH-0-1	CCHP-0-8	Not Req'd	CET-FRF-0

Contact/Wire Seal Plugs

Contact Size*	Part Number		Wire Seal Plugs	Colors
	Pin	Socket		
16	030-1878-001	031-1040-001	225-0071-000	Blue
12	030-1879-003	031-1041-003	225-0072-000	Yellow
8	030-1880-001	031-1042-001	225-1009-000	Red
4	030-1881-001	031-1043-001	225-1008-000	Blue
0	030-8011-747	031-8012-747	225-1007-000	Yellow

*Consult factory for variations in contact finish, wire accommodation, and thermocouple materials.

Wire Stripping

Using proper assembly tools (see page 214), strip insulation from end of wire to be crimped. (See table for proper stripping dimensions.) Do not cut or damage wire strands.

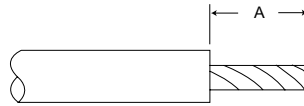

Contact Size	A	
	Max.	Min.
16	.250 (6.35)	.220 (5.59)
12	.250 (6.35)	.220 (5.59)
8	.250 (6.35)	.220 (5.59)
4	.480 (12.18)	.450 (11.43)
0	.630 (16.00)	.600 (15.24)

Assembly Instructions

Contact Crimping

Insert wire into rear of contact. Wire insulation must butt against rear of contact. Wire must be visible thru inspection hole. Using M22520/1-01 crimp tool with proper locator, insert wire and contact into locator jaws. Squeeze tool handle together until ratchet releases. When using CBT 600B crimp tool, follow instructions supplied with tool. Inspect crimped contact to be sure proper crimp has been made.



Contact Insertion



1. Slide conduit adapter or clamp bars over wire bundle in proper order for re-assembly.



2. Slide wired contact into proper insertion tool so that tip of tool butts against contact shoulder.



3. Inset wired contacts into cavities from rear of insulator until contact "clicks" into retaining clip. A slight pull on wire will assure that contact is securely seated.

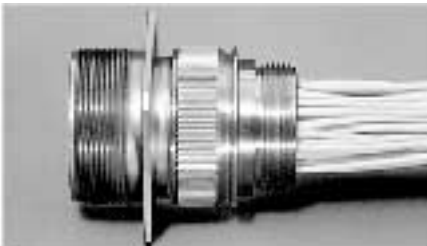

4. After all contacts are inserted, assemble conduit adapter or clamp bars.

Contact Extraction

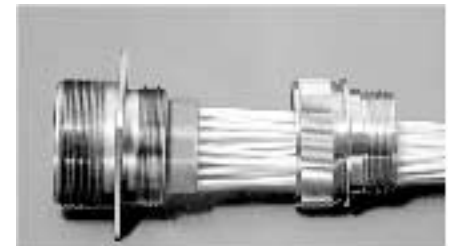

1. Remove conduit adapter or clamp bars from connector assembly.



2. Using proper extraction tool, insert tool around contact from front of insulator until tool tip butts against contact shoulder. Push plunger to release contact.



3. Pull wired contact out from rear of insulator.



4. After replacing contact, re-assemble conduit adapter or cable clamp.

Contact Arrangements

LEGEND

- Available in MS-K (page 202)
- Available in FRF (page 210)
- Available in CA-KE (page 206)
- † Available with MS polarization

Shell Size	8S-1	10S-2	10SL-3	10SL-4	12S-3†	12S-4	14S-1	14S-2†
No. of Contacts	1 #16	1 #16	3 #16	2 #16	2 #16	1 #16	3 #16	4 #16
Service Rating	A	A		A	A	D		
Shell Size	14S-5†	14S-6	14S-9†	16S-1†	16S-8†	16-9†	16-11†	
No. of Contacts	5 #16	6 #16	2- #16	7 #16	5 #16	2 #16 (B,D) 2 #12 (A,C)	2 #12	
Service Rating	Inst.	Inst.	A	A	A		A	
Shell Size	16-12†	16-13†	18-1†	18-12†	20-17†	20-18†	20-27†	
No. of Contacts	1 #4	2 #12 (A-Iron; B- B-Constantan)	10 #16	6 #16	1 #16(F) 5 #12(A-E)	6 #16(A,C-E,G,H) 3 #12(B,F,I)	14 #16	
Service Rating	A	A	A(B,C,F,G) Inst. (all others)	A	A	A	A	
Shell Size	22-14†	22-19†	22-22†	24-5†	24-10†	24-28†		
No. of Contacts	19 #16	14 #16	4 #8	16 #16	7 #8	24 #16 24 #16		
Service Rating	A	A		A	A	Inst.		
Shell Size	28-2†	28-11†	28-12†	28-15†	28-21†	28-22†		
No. of Contacts	12 #16(A,L,N) 2 #12(M,P)	18 #16(A-I, N-X) 4 #12(J-M)	26 #16	35 #16	37 #16	3 #16(D-F) 3 #4(A-C)		
Service Rating	D	A	A	A	A	D		

Contact Arrangements

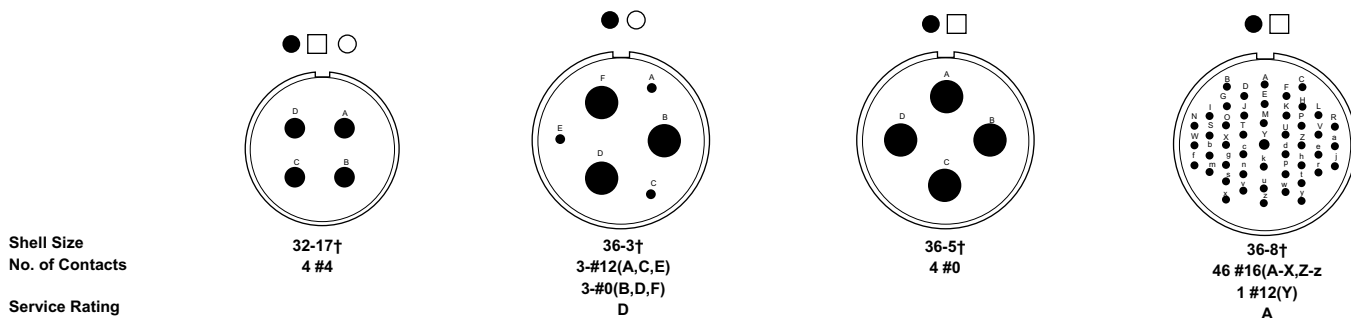
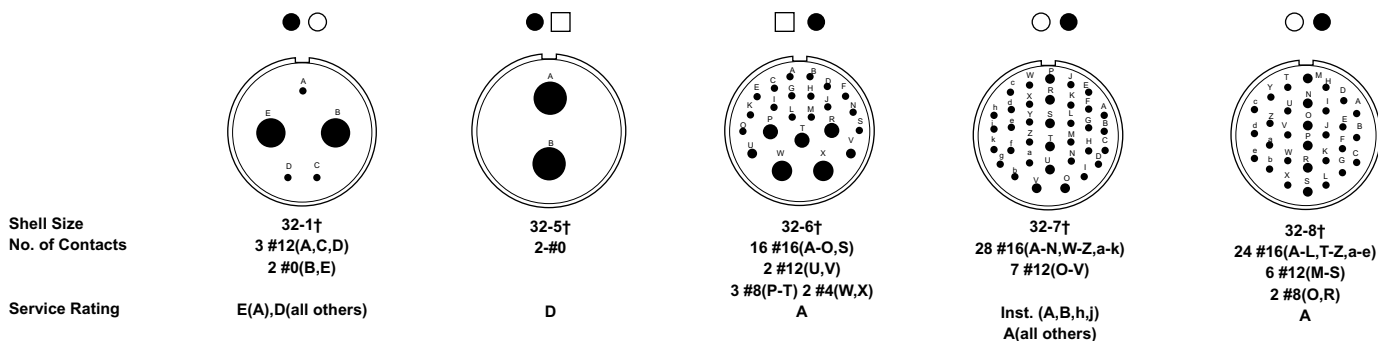

Alternate Positions

Pin front view;
Shell rotation

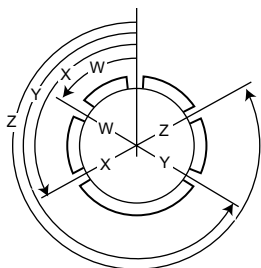

No. of Contacts	Contact Arrangement	Degrees				No. of Contacts	Contact Arrangement	Degrees						
		W	X	Y	Z			W	X	Y	Z			
2	12S-3	70	145	215	290	9	20-18	35	110	250	325			
	14S-9	70	145	215	290		10	18-1	70	145	215	290		
	16-11	35	110	250	325			14	20-27	35	110	250	325	
	16-13	35	110	250	325				22-19	80	110	250	280	
	32-5	35	110	250	325				28-2	35	110	250	325	
4	14S-2	-	120	240	-	16	24-5	80	110	250	280			
	16-9	35	110	250	325		19	22-14	80	-	-	280		
	22-22	-	110	250	-			22	28-11	80	110	250	280	
	32-17	45	110	250	-				23	32-6	80	110	250	280
	36-5	-	120	240	-					24	24-28	80	110	250
5	14S-5	-	110	-	-	26	28-12	90	180	270	-			
	16S-8	-	170	265	-		30	32-8	80	125	235	280		
	32-1	80	110	250	280			35	28-15	80	110	250	280	
	18-12	80	-	-	280				32-7	80	125	235	280	
6	20-17	90	180	270	-	37	28-21	80	110	250	280			
	28-22	70	145	215	290		47	36-8	80	110	250	280		
	36-3	70	145	215	290			7	16S-1	80	-	-	280	
	16S-1	80	-	-	280				24-10	80	-	-	280	



Design Features

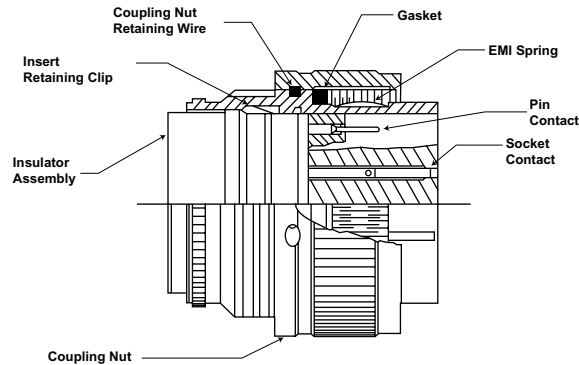

Front Release System using standard MS tooling

Cannon's M28840/KFS connectors are designed to meet the rigid specifications of MIL-C-28840. These circular, threaded coupling connectors feature high contact density, front release crimp contacts, high impact shock resistance, and are designed for use with navy shipboard cable MIL-C-915, MIL-C-24640, MIL-C-24643 and MIL-W-16878 wire.

M28840/KFS connectors utilize fluid resistant, fluorosilicone elastomers to provide maximum protection against fuels, oils, coolants and cleansers.

High quality manufacturing processes and materials combine to ensure the optimum in performance and reliability under an extreme range of environmental conditions, which include high impact shock, corrosion, vibration, moisture-resistance and water pressure. Temperature withstanding capabilities range from -55°C to +200°C (-67°F to +392°F)

M28840/KFS connectors are available in nine shell sizes, accommodating from seven contacts in shell size 11 up to 155 contacts in shell size 33, and have a multiple keying arrangement to prevent mismatching.

Also available as KFS connectors are printed circuit contacts for a variety of P.C. board/flex circuit applications, 16 AWG contact sizes,* EMP adapters/EMI RFI filters, connector savers, press fit solder pins and fiber optic contacts, high performance EMI version and thru-bulkhead fittings.

EMI Shielding

EMI suppression is obtained by means of spring fingers located on the plug. During mating, multiple spring fingers make contact with the receptacle at least .040 (1.02) before pin and socket electrical engagement occurs. In addition, a metal to metal shield is obtained when accessories are attached to the rear of the connector through a unique spline and ramp system. This total system provides the most effective EMI protection in the industry.

Scoop Proof

100% scoop-proof protection on all connectors eliminates bent pins as well as inadvertent electrical contact whether pins are mounted in the plug or receptacle.

Multiple Keying

Locksmith keying allows alternate polarizations eliminating the possibility of mismatching.

Quick Engagement

Double start-rapid advance thread provides rapid engagement and disengagement of connector in 1-1/2 turns.

High Density

Maximum density of contacts is obtained without sacrificing ruggedness required for high shock and vibration while holding size to a minimum.

Corrosion Resistant**

Standard finish - olive drab chromate over cadmium over nickel finish provides in excess of 500 hours of protection from salt spray without degradation of connector performance. Stainless steel with black chromate over cadmium over nickel finish provides protection in areas of direct salt exposure.

* Consult factory

**KFS connectors are available using alternate materials which will exceed a ten thousand hour (10,000 hrs.) salt spray. These connectors are intermateable & intermountable with both aluminum and stainless steel connectors from ITT Cannon.

Contact Arrangements

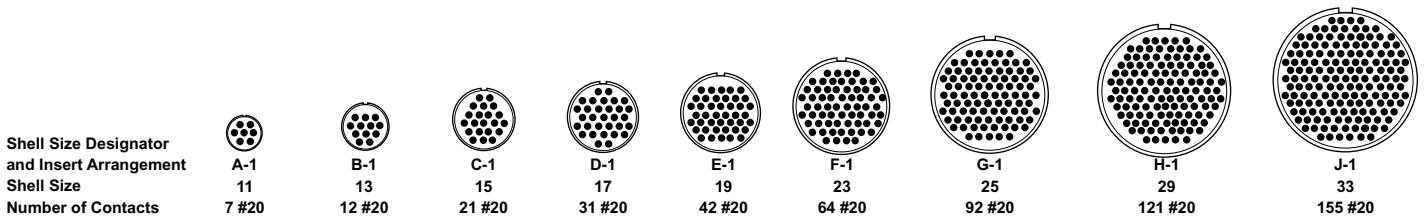

Components - Standard

Standard Contact Part Numbers

Mating End Size	Wire Barrel Size	MS Contact Part Number		Cannon Contact Part Number	
		Pin	Socket	Pin	Socket
		20	20	M39029/83-508	M39029/84-509
20	22	M39029/83-450	M39029/84-452	030-8008-800	031-8004-300
20	28	M39029/83-451	M39029/84-453	030-8009-100	031-8004-400

Seal Plug Part Numbers

MS Seal Plug Part Number	Cannon Seal Plug Part Number
MS27186	980-8003-000
MS27186	980-8003-000
MS27186	980-8003-000

How to Order

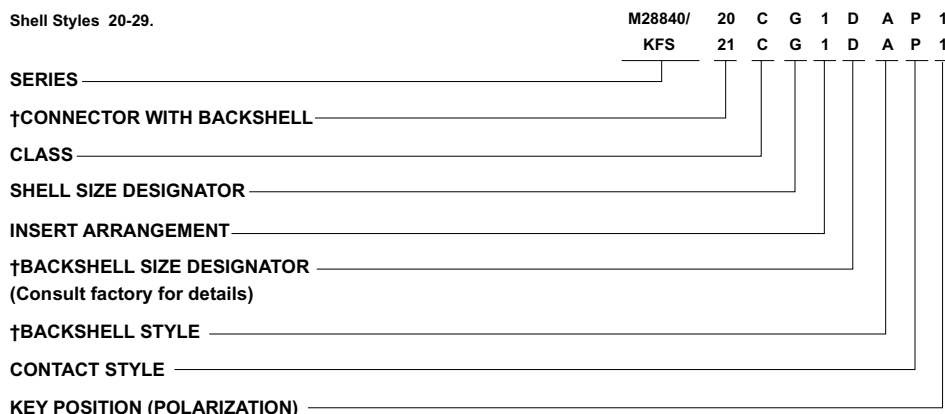
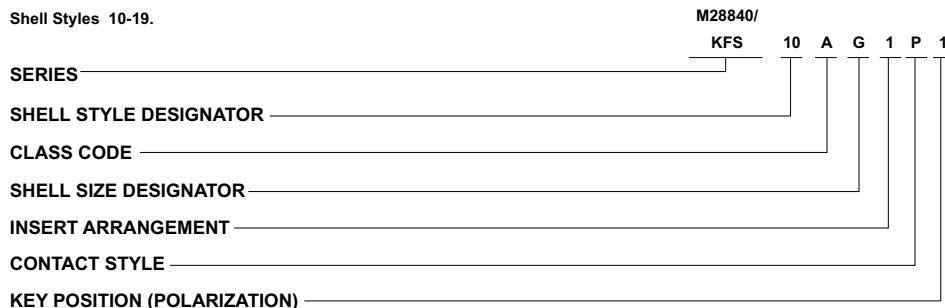

†Add for connector with backshells.

SERIES

M28840 - MIL-C-28840 Prefix
 **KFS - ITT Cannon Prefix for non-specification connectors

SHELL STYLE DESIGNATOR

Use shell styles 10-16 when ordering connectors without backshells.

- 10 - Receptacle, Wall Mounting
- 11 - Receptacle, Cable Connecting
- 12 - Receptacle, Box Mounting, Non-Environmental
- 14 - Receptacle, Jam Nut Mounting
- 16 - Plug, Cable Connecting

Use shell styles 17-19 when ordering connectors with strain reliefs.

- 17 - Plug, Cable with Connection Strain Relief, Open Wire straight
- 18 - Plug, Cable with Strain Relief, Open Wire 90°
- 19 - Plug, Cable with Strain Relief, Open Wire 45°

Use shell styles 20-29 when ordering connectors with backshells.

- 20 - Receptacle, Wall Mounting with Backshell, Jacket Cable Straight
- 21 - Receptacle, Cable Connecting with Backshell, Jacket Cable Straight
- 26 - Plug, Cable Connecting with Backshell, Jacket Cable Straight
- 28 - Plug, Cable Connecting with Backshell, Jacket Cable 90°
- 29 - Plug, Cable Connecting with Backshell, Jacket Cable 45°

CLASS

Code Letter	Class	Description
A	D	Aluminum Alloy connector with Cadmium (olive drab) over electroless nickel finish-fluorosilicone elastomer seals.
B	DS	Stainless Steel Connector with Cadmium (black) finish-fluorosilicone elastomer seals.
C	DJ	Aluminum Alloy Backshell-Connector Assembly with Cadmium (olive drab) over electroless nickel finish-fluorosilicone elastomer seals.
E	DJS	Stainless Steel Backshell-Connector Assembly with Cadmium (black) finish-fluorosilicone elastomer seals.

BACKSHELL SIZE

(Applies to Shell Style 20, 21, 26, 28, 29 only)
 A, B, C, or D
 The backshell sizes are identified by the appropriate letter: A, B, C or D depending upon cable diameter as shown in the plug assembly section of this catalog

BACKSHELL STYLE

(Applies to Shell Style 20, 21, 26, 28, 29 only)
 A - EMI Jacketed Cable
 B - Non-EMI Jacketed Cable

CONTACT STYLE

- P - Contact, No. 20 Pin with Crimp for 22-26 Gauge
- S - Contact, No. 20 Socket with Crimp for 22-26 Gauge
- D - Contact, No. 20 Pin with Crimp for 28 Gauge
- E - Contact, No. 20 Socket with Crimp for 28 Gauge
- F - Contact, No. 20 Pin with Crimp for 20 Gauge
- G - Contact, No. 20 Socket with Crimp for 20 Gauge
- A - Pin Insert-Less Contacts*
- B - Socket Insert-Less Contacts*

SHELL SIZE AND INSERT ARRANGEMENT

Shell Size Designator	Shell Size	Insert Arrangement	No. of Contacts
A	11	1	7
B	13	1	12
C	15	1	21
D	17	1	31
E	19	1	42
F	23	1	64
G	25	1	92
H	29	1	121
J	33	1	155

KEY POSITION (POLARIZATION)

1,2,3,4,5,6

*A and B signify a mixed complement of contact crimp barrel sizes. Contacts must be ordered separately, consult factory. Used only with KFS designation.

**Consult factory for connector savers, EMI versions and corrosion resistant connectors & adapters.

Wall Mounting Receptacle

M28840/10
(Class D and DS)

KFS10

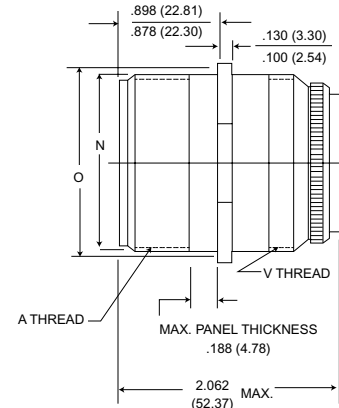
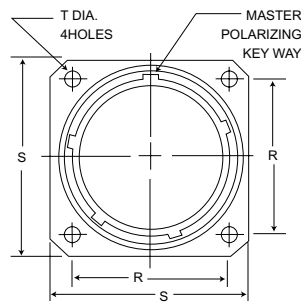
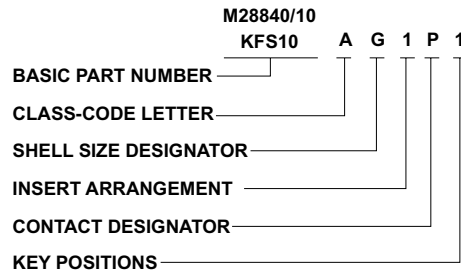

Shell Size Designator	Shell Size	A Thread Class 2A	V Thread Class 2A	N Dia. Max.	O Dia. (Ref. Mtg. Hole)	R T.P.	S ±.020 (0.51)	T Dia. +.015 (0.38) - .000 (0.00)
A	-11	.750 -1P-.2L-D.S.	3/4-20 UNEF	.750 (19.05)	.812 (20.62)	.750 (19.05)	1.023 (25.98)	.115 (2.92)
B	-13	.875 -1P-.2L-D.S.	7/8-20 UNEF	.875 (22.22)	.937 (23.80)	.843 (21.41)	1.138 (28.91)	.115 (2.92)
C	-15	1.062 -1P-.2L-D.S.	1-20 UNEF	1.062 (26.97)	1.124 (28.55)	.968 (24.59)	1.258 (31.95)	.115 (2.92)
D	-17	1.125 -1P-.2L-D.S.	1-1/8-18 UNEF	1.125 (28.58)	1.187 (30.15)	1.015 (25.78)	1.383 (35.13)	.115 (2.92)
E	-19	1.312 -1P-.2L-D.S.	1-1/4-18 UNEF	1.312 (33.32)	1.374 (34.90)	1.140 (28.96)	1.508 (38.30)	.115 (2.92)
F	-23	1.500 -1P-.2L-D.S.	1-7/16-18 UNEF	1.500 (38.10)	1.562 (39.67)	1.281 (32.54)	1.718 (43.64)	.115 (2.92)
G	-25	1.625 -1P-.2L-D.S.	1-9/16-18 UNEF	1.625 (41.28)	1.687 (42.85)	1.392 (35.36)	1.818 (46.18)	.142 (3.61)
H	-29	1.812 -1P-.2L-D.S.	1-7/8-16 UN	1.812 (46.02)	1.937 (49.20)	1.568 (39.83)	2.138 (54.31)	.142 (3.61)
J	-33	2.000 -1P-.2L-D.S.	2-1/16-16 UNS	2.000 (50.80)	2.124 (53.95)	1.734 (44.04)	2.328 (59.13)	.168 (4.27)

Cable Connecting Receptacle

M28840/11
(Class D and DS)

KFS11

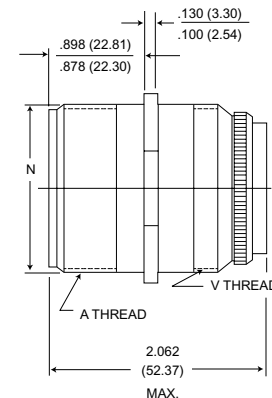
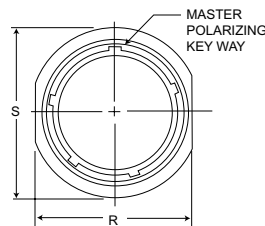
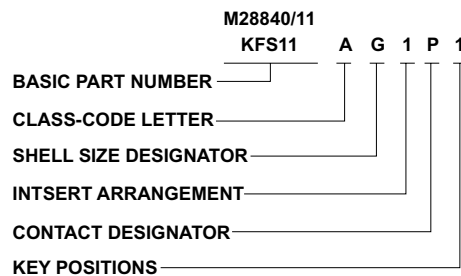

Shell Size Designator	Shell Size	A Thread Class 2A	V Thread Class 2A	N Dia. Max.	R ±.005 (0.13)	S ±.010 (0.25)
A	-11	.750 -1P-.2L-D.S.	3/4-20 UNEF	.750 (19.05)	.763 (19.38)	.953 (24.21)
B	-13	.875 -1P-.2L-D.S.	7/8-20 UNEF	.875 (22.22)	.888 (25.56)	1.078 (27.38)
C	-15	1.062 -1P-.2L-D.S.	1-20 UNEF	1.062 (26.97)	1.075 (27.30)	1.265 (32.13)
D	-17	1.125 -1P-.2L-D.S.	1-1/8-18 UNEF	1.125 (28.58)	1.138 (28.91)	1.328 (33.73)
E	-19	1.312 -1P-.2L-D.S.	1-1/4-18 UNEF	1.312 (33.32)	1.325 (33.66)	1.515 (38.48)
F	-23	1.500 -1P-.2L-D.S.	1-7/16-18 UNEF	1.500 (38.10)	1.513 (38.43)	1.703 (43.26)
G	-25	1.625 -1P-.2L-D.S.	1-9/16-18 UNEF	1.625 (41.28)	1.638 (41.61)	1.828 (46.43)
H	-29	1.812 -1P-.2L-D.S.	1-7/8-16 UN	1.812 (46.02)	1.888 (47.96)	2.078 (52.78)
J	-33	2.000 -1P-.2L-D.S.	2-1/16-16 UNS	2.000 (50.80)	2.075 (52.70)	2.265 (57.53)

Box Mounting Receptacle

M28840/12
(Class D and DS)

KFS12

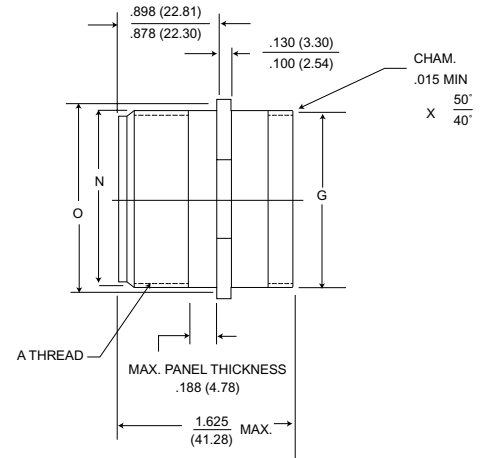
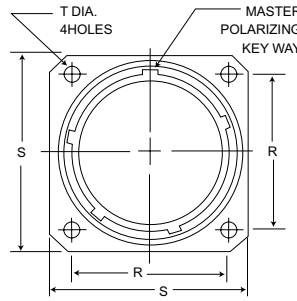
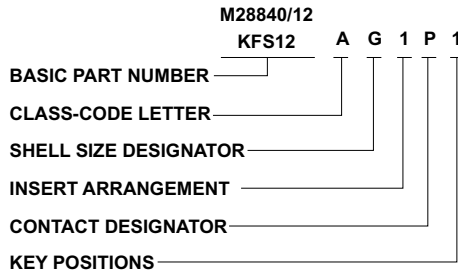

Shell Size Designator	Shell Size	A Thread Class 2A	N Dia. Max.	O Dia. (Ref. Mtg. Hole)	R T.P.	S ±.020 (0.51)	T Dia. +.015 (0.38) - .000 (0.00)	G Max.
A	-11	.750 -1P-.2L-D.S.	.750 (19.05)	.812 (20.62)	.750 (19.05)	1.023 (25.98)	.115 (2.92)	.755 (19.18)
B	-13	.875 -1P-.2L-D.S.	.875 (22.22)	.937 (23.80)	.843 (21.41)	1.138 (28.91)	.115 (2.92)	.880 (22.35)
C	-15	1.062 -1P-.2L-D.S.	1.062 (26.97)	1.124 (28.55)	.968 (24.59)	1.258 (31.95)	.115 (2.92)	1.005 (25.53)
D	-17	1.125 -1P-.2L-D.S.	1.125 (28.58)	1.187 (30.15)	1.015 (25.78)	1.383 (35.13)	.115 (2.92)	1.130 (28.70)
E	-19	1.312 -1P-.2L-D.S.	1.312 (33.32)	1.374 (34.90)	1.140 (28.96)	1.508 (38.30)	.115 (2.92)	1.255 (31.88)
F	-23	1.500 -1P-.2L-D.S.	1.500 (38.10)	1.562 (39.67)	1.281 (32.54)	1.718 (43.64)	.115 (2.92)	1.443 (36.65)
G	-25	1.625 -1P-.2L-D.S.	1.625 (41.28)	1.687 (42.85)	1.392 (35.36)	1.818 (46.18)	.142 (3.61)	1.567 (39.80)
H	-29	1.812 -1P-.2L-D.S.	1.812 (46.02)	1.937 (49.20)	1.568 (39.83)	2.138 (54.31)	.142 (3.61)	1.880 (47.75)
J	-33	2.000 -1P-.2L-D.S.	2.000 (50.80)	2.124 (53.95)	1.734 (44.04)	2.328 (59.13)	.168 (4.27)	2.067 (52.50)

Jam Nut Receptacle

M28840/14
(Class D and DS)

KFS14

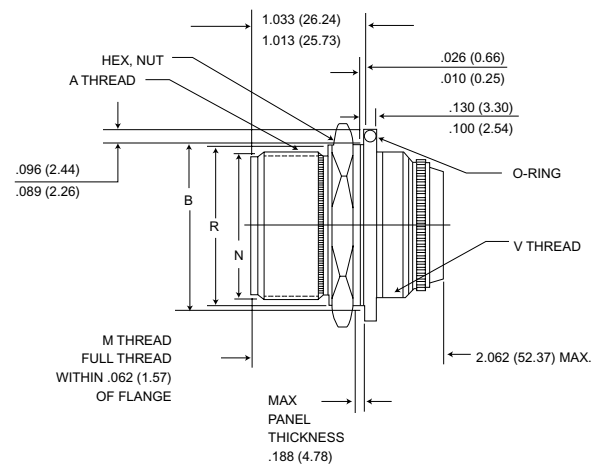
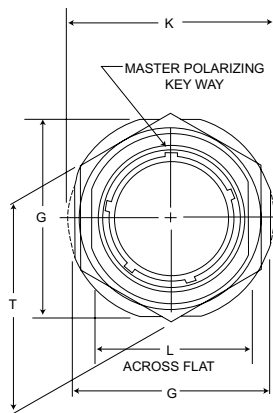
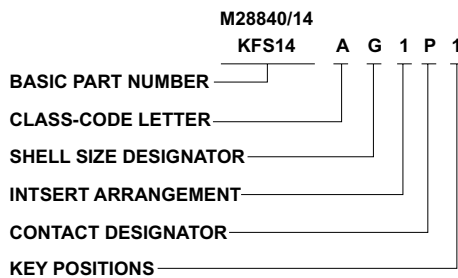

Shell Size Designator	Shell Size	A Thread Class 2A	M Thread Class 2A	V Thread Class 2A	G ±.010 (0.25)	K ±.010 (0.25)	L ±.009 (0.23) - .000 (0.00)	N Max.	R Max.	B ±.005 (0.13)	T ±.017 (0.43)
A	-11	.750 -1P-.2L-D.S.	7/8-20 UNEF	3/4-20 UNEF	1.264 (32.11)	1.358 (34.49)	.832 (21.13)	.750 (19.05)	.875 (22.22)	.974 (24.74)	1.062 (26.97)
B	-13	.875 -1P-.2L-D.S.	1-20 UNEF	7/8-20 UNEF	1.389 (35.28)	1.498 (38.05)	.957 (24.31)	.875 (22.22)	1.000 (25.40)	1.099 (27.91)	1.188 (30.18)
C	-15	1.062 -1P-.2L-D.S.	1-3/16-18 UNEF	1-20 UNEF	1.577 (40.06)	1.671 (42.44)	1.144 (29.06)	1.062 (26.97)	1.188 (30.18)	1.287 (32.69)	1.375 (34.92)
D	-17	1.125 -1P-.2L-D.S.	1-1/4-18 UNEF	1-1/8-18 UNEF	1.639 (41.63)	1.733 (44.02)	1.207 (30.66)	1.125 (28.58)	1.250 (31.75)	1.349 (34.26)	1.438 (36.53)
E	-19	1.312 -1P-.2L-D.S.	1-7/16-18 UNEF	1-1/4-18 UNEF	1.827 (46.41)	1.921 (48.79)	1.394 (35.41)	1.312 (33.32)	1.438 (36.53)	1.537 (39.04)	1.625 (41.28)
F	-23	1.500 -1P-.2L-D.S.	1-5/8-18 UNEF	1-7/16-18 UNEF	2.014 (51.16)	2.108 (53.54)	1.582 (40.18)	1.500 (38.10)	1.625 (41.28)	1.724 (43.79)	1.812 (46.02)
G	-25	1.625 -1P-.2L-D.S.	1-3/4-18 UNS	1-9/16-18 UNEF	2.139 (54.33)	2.233 (56.72)	1.707 (43.36)	1.625 (41.28)	1.750 (44.45)	1.849 (46.96)	2.000 (50.80)
H	-29	1.812 -1P-.2L-D.S.	1-15/16-16 UN	1-7/8-16 UN	2.327 (59.11)	2.425 (61.60)	1.894 (48.11)	1.812 (46.02)	1.938 (49.23)	2.037 (51.74)	2.188 (55.58)
J	-33	2.000 -1P-.2L-D.S.	2-1/8-16 UN	2-1/16-16 UNS	2.514 (63.86)	2.608 (66.24)	2.082 (52.88)	2.000 (50.80)	2.125 (54.98)	2.224 (56.49)	2.375 (60.32)

Cable Connecting Plug

M28840/16
(Class D and DS)

KFS16

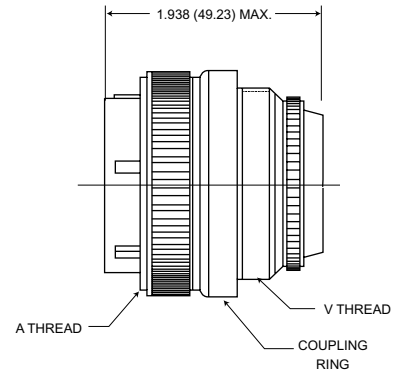
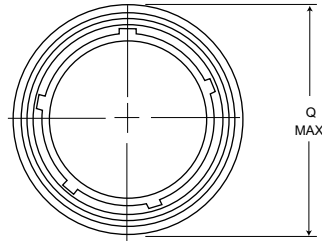
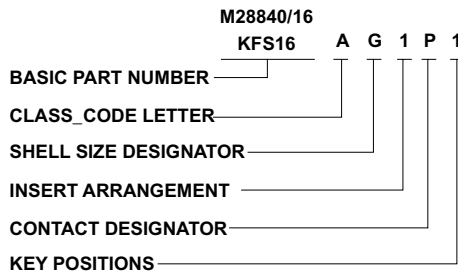

Shell Size Designator	Shell Size	A Thread Class 2B	V Thread Class 2A	Q Dia. Max.
A	-11	.750 -.1P-.2L-D.S.	3/4-20 UNEF	1.028 (26.11)
B	-13	.875 -.1P-.2L-D.S.	7/8-20 UNEF	1.141 (28.98)
C	-15	1.062 -.1P-.2L-D.S.	1-20 UNEF	1.263 (32.08)
D	-17	1.125 -.1P-.2L-D.S.	1-1/8-18 UNEF	1.387 (35.23)
E	-19	1.312 -.1P-.2L-D.S.	1-1/4-18 UNEF	1.513 (38.43)
F	-23	1.500 -.1P-.2L-D.S.	1-7/16-18 UNEF	1.703 (43.26)
G	-25	1.625 -.1P-.2L-D.S.	1-9/16-18 UNEF	1.825 (46.36)
H	-29	1.812 -.1P-.2L-D.S.	1-7/8-16 UN	2.143 (54.43)
J	-33	2.000 -.1P-.2L-D.S.	2-1/16-16 UNS	2.329 (59.16)

Backshell Styles

M28840

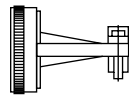

M28840/1

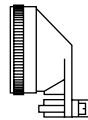

M28840/2

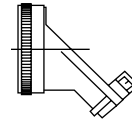

M28840/3

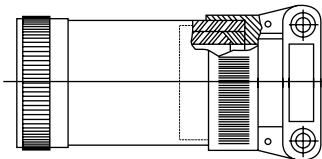

M28840/6

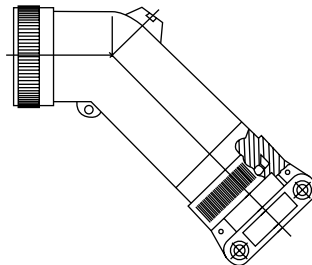

M28840/9

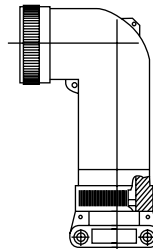

M28840/8

KFS-UBK/KFS-RBK/KFS-TBK

Spin coupling adapter and heat shrinkable boots.

(For UBK - Unshielded Boot, RBK - Shielded Boot, TBK - *Tinel-Lock-Shielded Boot.)

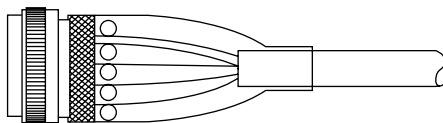

Straight (-00°)

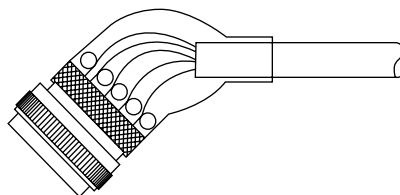

45° (-45°)

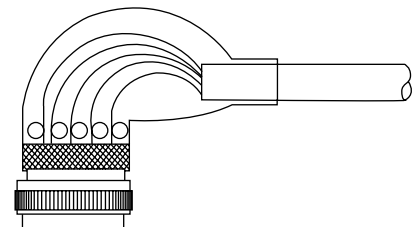

Right Angle (-90°)

Consult ITT Cannon Canada for ordering information.

*Trademark of Raychem



Cannon

Dimensions are shown in inches (millimeters).
Dimensions subject to change.

www.ittcannon.com

KFS Aluminum Bronze (AB)Series, Corrosion Resistant

The KFS/AB/series of connecting devices has been developed specifically for long term corrosion resistance without sacrificing mechanical strength or electrical requirements. The AB series is capable of withstanding at least 10,000 hours of salt spray without noticeable change in performance and is completely intermountable/intermountable with their aluminum and stainless steel counterparts. All MIL-C-28840 parameters have been maintained. Applications include - Navy shipboard, both above and below decks, submersibles including ROV's, towed bodies and submarines for military/defence and R&D/leisure applications.

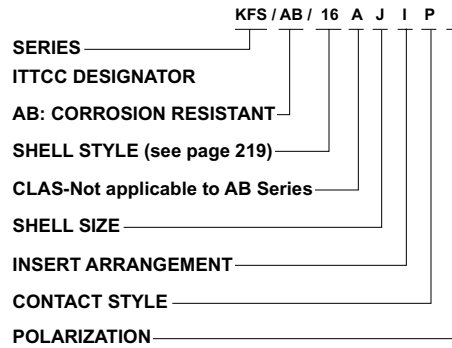

KFS/SB Series

This series features a solder zone for braided cable and a lip to accommodate a shrink boot. The standard M28840 is threaded to accept a large metal backshell for the very heavy MIL-C-915 type cables. Recently, low smoke, halogen free cable has been introduced which is quite flexible and does not need a heavy backshell. EMI shielding effectiveness has been greatly enhanced by soldering the braid directly to the connector.

Note: All M28840 parameters (including tooling) have been maintained.

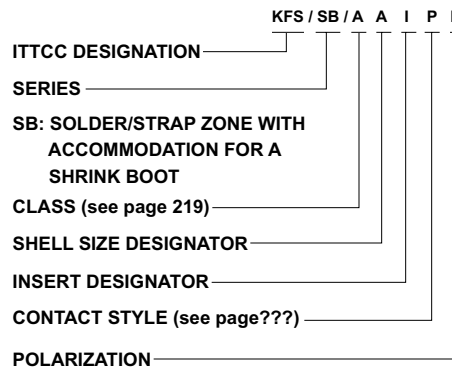

KFS/CB Connector Saver Series

KFS/CSF Connector Saver with flange

KFS/TBR Connector Saver thru-bulkhead receptacle

This series of connecting devices is used to protect the M28840/KFS receptacle interface (either pin or socket) from damage. The TBR series is a thru-bulkhead receptacle which allows cable plugs to be wired and tested prior to final assembly. Plugs are then mated to the mounted TBR connector to complete the installation.

The connector saver, connector saver with flange and thru-bulkhead receptacle all feature a hard dielectric insert assembly with lead-in chamfers for positive alignment of pins and sockets. Environmental sealing is maintained per MIL-C-28840 by way of a gasket seal under the coupling nut mechanism. The series conforms to all parameters outlined in MIL-C-28840 and is intended to be used in areas of extreme abuse. A clear cadmium over nickel plate identifies the CS series from standard product.

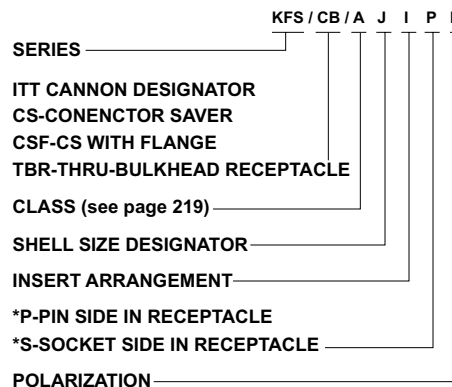

ITT Cannon's circular bayonet coupling connectors are basically MIL-C-5015 type connectors that provide superior performance.

Cannon's CA Bayonet is designed for the most difficult environmental conditions.

The insulators, grommets and o-rings are all made of high quality polychloroprene or high performance fuel resistant fluoroelastomers that can withstand temperature extremes from -55°C to +200°C.

Cannon designed the CA Bayonet with a gradual slope of the coupling ramp and unique roller bolt (not a fixed stud) bayonet pins. A quick 120 degrees turn of the coupling nut and the roller bolt audibly locks into place. The locked position is marked with colored arrows. The roller bolt feature eliminates the need for a strap wrench by reducing coupling forces. Reduced friction means reduced wear.

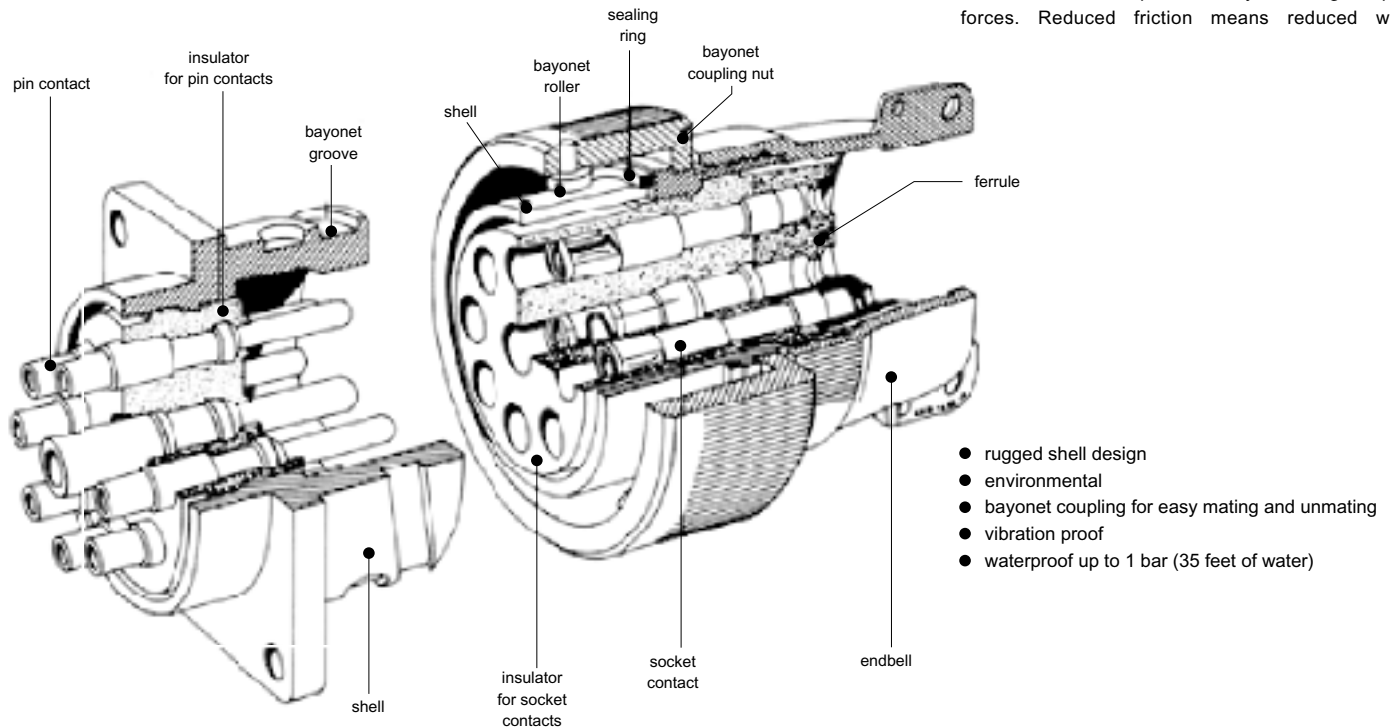

Performance and Material Specifications - CA Bayonet

MATERIALS AND FINISHES

Item	Material	Finish
Shell	Aluminum Alloy	Olive drap chromate coating over cadmium plating. Special Finish: A 105 clear chromate coating over cadmium plating.
Insulator	Polychloroprene	-
Grommets	Polychloroprene	-
Contacts	Copper Alloy	Hard Silver Special Finish: A 176 nickel and hard gold plating.

MECHANICAL FEATURES

Ambient temperature:	-55/125°C (-67/257°F)
Safety provisions:	IP 67 according to DIN 40050 (1 bar pressure after 12 hrs.)
Vibration test:	200 m/s ² at 10 to 2000 Hz
Mating cycles:	Min. 500

ELECTRICAL DATA

Contact rating at 68°F (+20°C)

Contact Size Awg/Metric	Max Current A
10	8
16S/15S	22
16/15	22
12/25	41
8/60/100	74
4/160	135
0/500	245

Test Voltage

According to VG95319 Part 2, Test Nr. 5.13 and VG 95210 Part 31. Test voltage for service rating:

Service rating	Test voltage Vrms
Instruments	1050
A	1600
B	4000
D	2500
E	3000

Contact Resistance

Contact resistance tested according to VG95319 Part 2, Test Nr.5.10.1









Contact Size (Metric)	Max. Contact Resistance AWG	M½
10	-	12
15S/15	16S/16	6
25	12	3
60/100	8	1
160	4	0,3
500	0	0.2

How to Order - CA Bayonet

		CA	3106	E	18-1	S	*	B	-	***
SERIES	_____	_____	_____	_____	_____	_____	_____	_____	_____	_____
SHELL STYLE	_____	_____	_____	_____	_____	_____	_____	_____	_____	_____
CLASS	_____	_____	_____	_____	_____	_____	_____	_____	_____	_____
SHELL SIZE	_____	_____	_____	_____	_____	_____	_____	_____	_____	_____
CONTACT ARRANGEMENT	_____	_____	_____	_____	_____	_____	_____	_____	_____	_____
TYPE OF CONTACT	_____	_____	_____	_____	_____	_____	_____	_____	_____	_____
POLARIZATION	_____	_____	_____	_____	_____	_____	_____	_____	_____	_____
CONNECTORS WITH BAYONET COUPLING	_____	_____	_____	_____	_____	_____	_____	_____	_____	_____
DASH	_____	_____	_____	_____	_____	_____	_____	_____	_____	_____
MODIFICATION	_____	_____	_____	_____	_____	_____	_____	_____	_____	_____

<p>SERIES CA - Circular Connectors</p> <p>SHELL STYLE 3100 Wall mounting receptacle 3101 Cable connecting plug 3102 Box mounting receptacle 3106 Plug, straight 3107 Jam nut receptacle (upon request) 3108 Plug 90</p> <p>CLASS E - Environmental with resilient insulators and endbell with clamp and bushing F - Environmental with resilient insulator and endbell for flex tube R - Environmental with resilient insulator and shortened light-weight endbell</p> <p>SHELL SIZE Size 10 SL to 36 are available.</p> <p>CONTACT ARRANGEMENT See page 227.</p> <p>CONTACT TYPE P - Pin contact S - Socket</p>	<p>POLARIZATION * Insert letter W, X, Y or Z On all CA connectors, MIL-C-5015 polarization is available. Polarization will be used to prevent mismatching. Polarization is achieved by turning the insulators clockwise (pin) and counterclockwise (socket) against the normal position of the shells. (See page 228)</p> <p>BAYONET COUPLING B - Bayonet coupling</p> <p>DASH</p> <p>MODIFICATION All CA Bayonet connectors come with installed solder contacts unless a modification code is added to the part number. 01 - Metric crimp contacts 02 - Adapter for shrink boots, AWG crimp contacts 03 - Adapter for shrink boots, metric crimp contacts</p>	<p>04 - Rear mounting, threaded holes, metric crimp contacts 05 - Rear mounting, through holes in flange 06 - Adapter for shrink boots 08 - 90° angle shell, threaded holes in flange* 09 - 90° end bell, 4 through holes* 13 - Endbell for shielded cables and heat shrink boots, solder contacts 14 - Endbell for shielded cables and heat shrink boots, metric crimp contacts 15 - Endbell for shielded cables and heat shrink boots, AWG crimp contacts 109 - F 80 rear mount with four threaded holes** 111 - Rear mount with four threaded holes*** F 80 - AWG crimp contacts F 42 - Less ferrule, grommet and backshell</p> <p>* for CA 3100 only ** For receptacles only *** For receptacles only</p>
--	--	---

Shell Styles

				
Front Mounting Receptacle CA 3102 E-B/-01/-F80	Rear Mounting Receptacle CA 3102 E-B/-04/-109/-111	Straight Plug With Cable Clamp CA 3106 E-B/-01/-F80	90° Plug With Cable Clamp CA 3108 E-B/-01/-F80	Cable Extension With Cable Clamp CA 3101 E-B/-01/-F80
				
Rear Mounting Wall Receptacle w Flange (Threaded Holes) and Cable Clamp CA 3100 E-B/-01/-F80	Flex Tube CA 3106 F-B/-01/-F80	Flanged Wall Mount Receptacle With Shrink Boot Adapter CA 3100 E-B/-02/-03/-06	Flanged Wall Mount Receptacle With Endbell, Shielded Cables and Heat Shrinkable CA 3108 F-B/-13/-14/-15	
Wall Mounting Receptacle with Cable Clamp (Through Holes) CA 3100 E-B/-05/01-05/05-F80				

CA-COM and CA-COM-B connectors meet the requirements of MIL-C-5015. They were developed especially for industrial usage. CA-COM series connectors offer the same mounting dimensions and contact arrangements as MIL-C-5015 and VG 95234 connectors.

CA-COM and CA-COM-B connectors are available as:

- Wall mounting receptacle
- Cable connecting plug
- Box mounting receptacle
- Plug straight
- Plug 90°

Wall mounting receptacles and cable connecting plugs (straight and 90°) are available with:

- Endbell with cable clamp
- Endbell for flex tubes
- Adapter combined for PG termination e.cc. to DIN46320 and
- Adapter for heat shrink boots

ITT Cannon also provides you with appropriate accessories like:

- Protective metal caps with sash chain
- Cable clamps
- Cable bushings
- Sealings gaskets



Advantages

- threaded coupling - CA-COM/bayonet coupling - CA-COM-B
- mateable with MIL-C-5015 connectors
- solder or crimp contacts
- contact arrangements with 1 to 61 contacts available
- wire size: 1.5mm² up to 50 mm²
- aluminum alloy shells withstand great mechanical strain
- surface protected by a nickel plating
- resilient insulator (Polychloroprene) for extreme temperatures (from - 55° to + 125°C)
- resistant against aggressive fluids like fuel, oil etc.
- environmental - with adapter for PG termination or heat shrink boots
- at least 500 mating cycles
- spray-water proof - CA-COM/waterproof (1 bar, 12 hours) - CA-COM-B (with modification - 44 which includes seal ring and grommet).

Performance and Material Specifications-CA-COM

MATERIALS

Shell	Aluminum alloy, nickel plated
Contacts	Copper alloy, tin plated
Insulator and grommets	Polychloroprene

ELECTRICAL

Rated Current	
20°C ambient temperature	
Contact Size	Max. Rated Current^⓪
16S/15S	22A
16/15	22A
12/25	41A

Other sizes, see Page 224

^⓪ This applies only to the max. rated current for one contact. If several contacts in one arrangement are loaded with higher current the specific heat and the ambient temperature may not exceed +125°C.

MECHANICAL

Max. operating temperature	- 55/125°C
Mating cycles	min. 500

How to Order-CA-COM

SERIES

CA - ITT Cannon designation

SHELL STYLE

- 00 - wall mounting receptacle
- 01 - cable connecting plug
- 02 - box mounting receptacle
- 20 - box mounting receptacle for rear mounting (only bayonet version)
- 06 - straight plug
- 08 - 90° plug

CLASS

- COM-E - endbell with cable clamp
- COM-F - endbell for flex tube
- COM-PG - adapter for heat shrink boots and PG termination, environmental
- COM-L - solder termination for printed circuits

SHELL SIZE

- 10SL, 12S, 14S, 16S, 16, 18,
- 20, 22, 24, 28, 32, 36

SERIES

SHELL STYLE

CLASS

SHELL SIZE

CONTACT ARRANGEMENT

CONTACT TYPE

ALTERNATE INSERT POSITION

BAYONET COUPLING*

MODIFICATION

* Do not use for CA-COM with thread coupling

CONTACT ARRANGEMENT

See page 227

CONTACT TYPE

- P - pin contact
- S - socket contact

ALTERNATE INSERT POSITION

Insert positions of insulator, see page 228

COUPLING B

- with bayonet coupling
- without designation: with threaded coupling

CA 06 COM-E 18 - 1 P * ***
CA 06 COM-E 18 - 1 P * B* ***

MODIFICATION*

- 01 - metric crimp contacts
- 03 - adapter for heat shrink and metric crimp contacts (Mod. for bayonet coupling)
- 06 - adapter for heat shrink and solder contacts (Mod. for bayonet coupling)
- DN - adapter for heat shrink boots solder contacts (Mod. for bayonet coupling)
- F80 - AWG crimp contacts

* All CA Bayonet connectors come with intalled solder contacts unless a modification code is added to the part number.

Contact Arrangements-CA Bayonet/CA-COM

Shell Size	Contact Arrangement	No. of contacts	Contact Size AWG	Shell Size	Contact Arrangement	No. of contacts	Contact Size AWG	Shell Size	Contact Arrangement	No. of contacts	Contact Size AWG	
10SL	10SL-3▲	3	16	18	18-22	3	16	24	24-22	4	8	
	10SL-4▲	2	16		18-23*	10	16		24-28	24	16	
12S	12S-1*	2	16	20	18-24*	10	16	28	24A24	12	12	
	12S-2*	2	16		18-25*	2	12		24A35	2	12	
	12S-3	2	16		18-27*	2	12			14	16	
	12S-4	1	16			1	16		28-11▲	4	12	
	12SA10	4	16		18A31*	10	16			18	16	
14S	14S-1	3	16	22	20-2▲	1	0	32	28-12	26	16	
	14S-2	4	16		24-4	4	12		28-13*	26	16	
	14S-4	1	16		20-6	3	16		28-15	35	16	
	14S-5	5	16		20-7	8	16		28-16	20	16	
	14S-6▲	6	16		20-8▲	2	8		28-20▲	10	12	
	14S-7	3	16			4	16			4	16	
	14S-9	2	16		20-11	13	16		28-21▲	37	16	
	14S-10	4	16		20-15▲	7	12		28-22	3	4	
	14S-11*	4	16		20-16	2	12			3	16	
	14S-12*	3	16			7	16		28A16	4	4	
	14S-13*	3	16		20-19	3	8			5	16	
	14S-14*	4	16		20-24	2	8		28A63▲	9	12	
	16S	16S-1▲	7		16		2		16		19	16
		16S-4	2		16	20-25	13		16	32-1▲	2	0
16S-5		3	16	20-27	14	16		3	12			
16S-8		5	16	20-29	17	16	32-5	2	0			
16S-15*		2	16	20-30*	13	16	32-6▲	2	4			
16S-16*		2	16	20-32*	8	16		3	8			
16SA18*		7	16	20-33	11	16		2	12			
16SA19*		7	16	20A9▲	9	12	32-7▲	7	12			
16SA20*		7	16	20A16	13	16		28	16			
16SA21*		7	16	20A48▲	19	16	32-8	6	12			
16		16-7	2	16	24	21-1	2	8		24	16	
			1	8		22-2▲	3	8	32-13	5	12	
		16-9	2	12			18	16		18	16	
			2	16		22-7	1	0	32-15	2	0	
	16-10▲	3	12	22-9		3	12		6	12		
	16-11	2	12	22-12▲		2	8	32-16*	2	4		
	16-12▲	1	4			3	16		3	8		
	18	18-1▲	10	16		22-14▲	19	16		2	12	
		18-3	2	12			5	12	32-17	4	4	
		18-4	4	16		22-15	1	16		4	4	
18-5		2	12		1	16	32-19*	2	0			
		1	16	22-19	14	16		3	12			
18-6		1	4	22-20	9	16	32-20*	2	4			
18-8		1	12	22-22▲	4	8		3	8			
		7	16	22-23	8	12		2	12			
18-9		2	12	22-27▲	1	8		16	16			
		5	16		8	16	32A10	54	16			
18-10		4	12	22-30*	19	16	32A30*	2	0			
18-11▲	5	12	24	24-2	7	12		3	12			
18-12	6	16		24-7	2	12	32A69▲	20	-			
18-13	1	8			14	16		41	-			
	3	12		24-9	2	4	36-3	3	0			
18-17*	2	12		24-10▲	7	8		3	12			
	5	16		24-11▲	3	8	36-5▲	4	0			
18-19	10	16			6	12	36-10▲	48	16			
18-20	5	16		24-12▲	2	4		48	16			
18-21	3	12			3	12	36-11*	48	16			
				24-19	12	16	36-12*	48	16			
				24-20	2	12	36-14	5	8			
				9	16		5	12				
							6	16				
							36-15	35	16			
							36A98	8	8			
								31	16			

▲ VG 95234 contact arrangement

* Standard contact arrangement with special alternation of contact insert

Alternate Insert Positions-CA Bayonet/CA-COM

Standard Inserts

X and Y are insert positions in accordance with VG 95234*

All views are looking into front of pin insert or rear of socket insert.



Normal Position

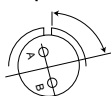

Position W

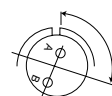

Position X

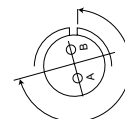

Position Y

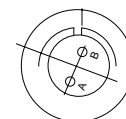

Position Z

Contact arrangement	W'	X'	Y'	Z'
10SL-3				
10SL-4				
12S-3	70	145	215	290
12SA-10				
14S-1				
14S-2		120	240	
14S-4				
14S-5		110		
14S-6				
14S-7	90	180	270	
14S-9	70	145	215	290
16S-1	80			280
16S-4	35	110	250	325
16S-5	70	145	215	290
16S-8		170	265	
16-7	80	110	250	280
16-9	35	110	250	325
16-10	90	180	270	
16-11	35	110	250	325
16-12				
18-1	70	145	215	290
18-3	35	110	250	325
18-4	35	110	250	325
18-5	80	110	250	280
18-6				
18-8	70			290
18-9	80	110	250	280
18-10		120	240	
18-11		170	265	
18-12	80			280
18-13	80	110	250	280
18-19				
18-20	90	180	270	
18-21				
18-22	70	145	215	290
20-2				
20-4	45	110	250	
20-6				
20-7	80	110	250	280
20-8	80	110	250	280
20-11				
20-16				
20-19	90	180	270	
20-24	35	110	250	325
20-27	35	110	250	325
20-29	80			280
20-33				
20A9		110	250	
20A48		80	280	

Contact arrangement	W'	X'	Y'	Z'
22-1	35	110	250	325
22-2	70	145	215	290
22-7				
22-9	70	145	215	290
22-12	80	110	250	280
22-14	80			280
22-15	80	110	250	280
22-19	80	110	250	280
22-20	35	110	250	325
22-22		110	250	
22-23	35		250	
22-27	80		250	280
22B22		110	250	
24-2	80			280
24-7	80	110	250	280
24-9	35	110	250	325
24-10	80			280
24-11	35	110	250	325
24-19				
24-20	80	110	250	280
24-22	45	110	250	
24-28	80	110	250	280
24A24				
28-11	80	110	250	280
28-12	90	180	270	
28-15	80	110	250	280
28-16	80	110	250	280
28-20	80	110	250	280
28-21	80	110	250	280
28-22	70	145	215	290
28A16				
28A63		100	260	
32-1	80	110	250	280
32-5	35	110	250	325
32-6	80	110	250	280
32-7	80	125	235	280
32-8	80	125	235	280
32-13	80	110	250	280
32-15	35	110	250	325
32-17	45	110	250	
32A69		110	250	
36-3	70	145	215	290
36-5		120	240	
36-10	80	125	235	280
36-14				
36-15	60	125	245	305
36A98				

* The degree figures indicate the angular position of the layout towards the polarizing key clockwise in view of the mating side of the pin or the termination side of socket contact insulators.

Tolerances of insert positions:
 shell size 10 SL to 22 ± 2°
 shell size 24 to 26 ± 1,5°
 Exception: Contact arrangement 32 A 69 ± 1°

These connectors are used to transmit very high current at low voltage, as for example in the electrical equipment of military land and sea-borne vehicles and in industrial facilities. The connectors meet the mating dimensions, mechanical features and rear panel installation requirements of VG 95234. Ultraflexible, shielded weld cables are terminated to the connectors.

These high power connectors feature one contact in a two-piece rigid insulator. The aluminum shell has a chromate finish over cadmium. The operating temperature ranges from -55°C to +125°C (-67°F to +257°F). The contacts of copper or copper alloy with hard silver finish are designed for crimping or termination to solid copper conductors with threaded bolts. The mechanical durability is a minimum of 500 mating cycles. The crimp contacts accept wires per DIN 46438 (25-240 sq. mm).

Contact retention is achieved by the two-piece insulator which is fixed to the shell with a snap-in ring. This allows unlimited exchange of the crimp contacts. The bayonet coupling assures fast coupling and uncoupling. Color-coded snap-in points indicate positive mating. Plugs and receptacles are waterproof in mated conditions up to 1 bar (35 feet of water).

Conector Design - CGE

Receptacle CGE2...B-04

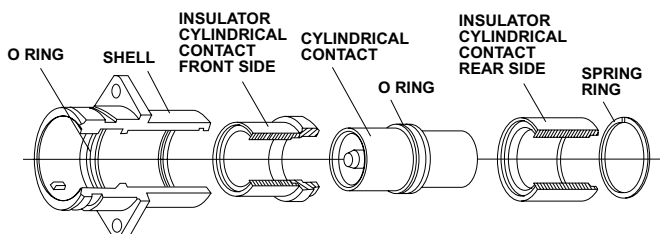

Plug CGE6...B-03

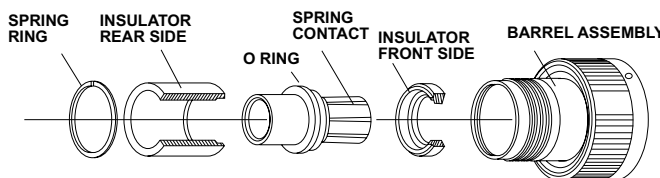

How To Order - CGE

SERIES

CGE - ITT Cannon Prefix

SHELL STYLE

- 0 - Wall mounting receptacle with mounting flange
- 1 - Cable connecting plug
- 2 - Box mounting receptacle with mounting flange
- 6 - Straight plug
- 8 - 90° angle plug

CLASS

E - Environmental, class JP 07, according to DIN 40050

SHELL SIZE

16 - 18 - 22 - 28 - 32

CONTACT ARRANGEMENT

- 16H2 - Shell size 16, 1 contact H2
- 18H5 - Shell size 18, 1 contact H5
- 22H9 - Shell size 22, 1 contact H9
- 28H15 - Shell size 28, 1 contact H15
- 32H24 - Shell size 32, 1 contact H24

SERIES

SHELL STYLE

CLASS

SHELL SIZE

CONTACT ARRANGEMENT

CONTACT SIZE

CONTACT TYPE

ALTERNATE KEYWAY POLARIZATION

BAYONET COUPLING

MODIFICATION

CONTACT SIZE

- H2 - 3 AWG
- H5 - 0 AWG
- H9 - 000 AWG
- H15 - 250 MCM
- H24 - 400 MCM

CONTACT TYPE

- F - Spring contact
- Z - Cylindrical contact

ALTERNATE KEYWAY POLARIZATION

- Standard - 180°
- W - 120°

CGE 6 E 32 H 24 F W B ***

BAYONET COUPLING

- B - Bayonet coupling

MODIFICATIONS

- 05 - Through holes in flange
- 03 - Adapter for heat shrink boots, metric size crimp contact
- 04 - Rear panel mounting, four threaded holes, metric size crimp contact
- 04-05 - Same as 04, however with four through holes
- 14 - shielded version, metric size crimp contact
- 16 - Thread bolt termination, front panel mounting, 0-ring for sealing between wall and receptacle (only for style CGE2EB)

Performance and Material Specifications -CGE

MECHANICAL

Admissible ambient temperature	- 55°C to +125°C
Class	IP 67 according to DIN 40050 Test pressure: 1 bar overpressure Test duration 12 hours
Vibration	200 m/s ² for 10 to 2000 Hz
Mechanical durability	500 mating cycles

COUPLING TORQUE

(IN WIRED CONDITION ACC. TO VG 95319 Part 2, Test No. 5.8.2.)

Shell Size	max. closing/opening torque		min. opening torque	
	Nm	ozm	Nm	ozm
16	5.5	19.78	0,5	1.80
18	8.0	28.78	0,6	2.16
22	11.0	39.57	0,8	2.88
28	17.0	61.15	0,9	3.24
32	19.0	68.34	1,0	3.60

3,597 = (Oz & Ozm)

CONTACT RETENTION

(ACC. TO VG 95319, PART 2. TEST NO. 5.4)

Contact Size	Metric Wire Size (mm ²)	American Wire Size (AWG) or (MCM)	Test Force	
			(N min.)	(Oz. min.)
H2	25	3 AWG	100	359.70
H5	50	0 AWG	120	431.64
H9	95	000 AWG	140	503.58
H15	150	250 AWG	160	575.52
H24	240	400 AWG	200	719.4

ELECTRICAL DATA

CONTACT RATING

(amps) at 125°C ambient temperature:

Shell size	16	18	22	28	32
Contact size	H2	H5	H9	H15	H24
Max. current rating (amps at 125°C ambient temperature)	250	300	500	650	1000
Max. short-time load approx. 0,5 - 1 sec. (amps.)	750	1000	2000	3000	5000

AIR AND CREEPAGE PATHS

Air path	.118 (3.00) min.
Creepage path	.197 (5.00) min.

CONTACT RESISTANCE

Contact Size	H2	H5	H9	H15	H24
Contact resistance (mOhm max.)	0,6	0,3	0,15	0,1	0,07

INSULATOR RESISTANCE

min. 5000 MOhm

MATERIALS AND FINISHES

Shell	Aluminum alloy
Finish	Olive chromate over cadmium
Insulator	PTFE
Contact	Copper and copper alloy
Finish	Hard silver
O-Rings	Viton

Alternate Keyway Positions - CGE

To avoid mismatching of identical connectors, the keyway of the CGE connectors is available in two different positions:

Standard Keyway position = 180°

Keyway position W = 120°

Keyway position of receptacles and cable connecting plugs.

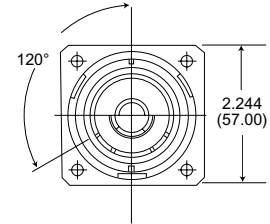
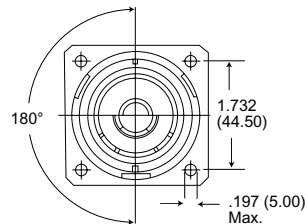

Keyway position of straight and 90° angle plugs.

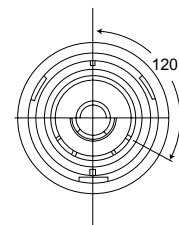
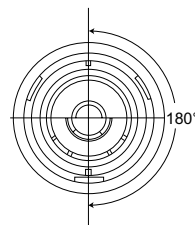

The Micro Line - .050" Contact Spacing



The Cannon MICRO Series established the standards for performance and reliability in miniature interconnects. Exceptionally versatile, MICRO connectors are available in rectangular, circular, and strip configurations, with 3 amp MICROPIN™/MICROSOCKET™ contacts on .050(1.27) centers, or with special arrangements of power and coaxial contacts.

The heart of the Cannon MICROPIN/MICROSOCKET contact system is a multi-element Twist Pin Contact recessed with an insulating housing. The rugged, cylindrical sockets are mounted in the exposed half of the connector. When connector

halves are mated, the chamfered sockets are first aligned by the connector body, then guide the spiral MICROPIN contacts into proper and positive alignment, even under worst-case tolerance conditions. This is Cannon's POS-A-LINE connectors design.

The multiple spring elements of the MICROPIN, then under compression, form a multi-point contact system of high mechanical and electrical integrity. Contacts will provide a high degree of reliability over hundreds of mating and unmating cycles, and have proven themselves in applications that range from commercial products to equipment that has been landed on the moon.

- Contact rating - 3 amps max.
- Contacts centers - .050(1.27).
- Wire sizes - #24 thru #32 AWG, stranded or solid.
- Contact termination - multiple indent crimp.
- Contact retention - fixed via epoxy.
- Contact materials and finish - Copper alloy, gold-plated per MIL-G-45204, Type II, Grade C, Class 1 over copper flash.
- Mating/unmating force - 8 oz. per contact, max./0.5 oz. per contact min.

Test Data

The table below summarizes the results of key tests performed in accordance with MIL-STD-1344, where applicable. Data is applicable to standard connectors with standard termination. Variations may affect this data, so please consult the factory for further information on your requirements.

Test	Method	Criteria of Acceptance
Dielectric Withstanding Voltage	Method 3001:	
	900 VAC at sea level	No breakdown
	300 VAC at 70,00' altitude	No breakdown
	Solder Pots and Shielded Cable 600 VAC at sea level 150 VAC at 70,000' altitude	No breakdown No breakdown
Insulation Resistance	Method 3003	5,000 megohms minimum
Thermal Shock	Method 1003, Condition A: - 55°C to +125°C	No physical damage
Physical Shock	Method 2004, Condition E: 50 G's, 3 axes, 6 millisecond duration sawtooth pulse	No physical damage No loss of continuity > 1 µsec
Vibration	Method 2005, Condition IV: 20 G's, 10-2,000 Hz. 12 hrs	No physical damage No loss of continuity > 1 µsec
Durability	500 cycles of mating and unmating, 500 CPH max.	No mechanical or electrical defects
Moisture Resistance	Method 1002, Type II omit steps 7a & 7B	Insulation resistance > 100 megohms
Salt Spray	Method 1001, Condition B: 48 hours	Shall be cable of mating and unmating, and meet contact resistance requirements
Contact Resistance (MIL-STD-202)	Method 307 At 3 amps At 1 milliamps	8 milliohms maximum 10 milliohms maximum
Contact Retention	Per MIL-C-83513	5 lb. minimum axial load



MDM connectors are used in applications requiring highly reliable, extremely small, lightweight connectors with higher density contact configurations than available in traditional rectangular connectors. They are available in 8 shell sizes accommodating from 9 to 100 contacts, and special arrangements of power and coaxial contacts.

These connectors are designed to meet the rapidly increasing demands for an environmental, high performance, rugged, moisture-sealed microminiature connector. This connector employs size 24 MICRO-

PIN[®]/MICROSOCKET[®] contacts on .050(1.27_ centers in a contact density identical to the standard MICRO-D connector series, but with these additional features:

¥ Aluminum shells to provide greater strength, prevent chipping, cracking or breaking, offer electromagnetic (EMI) and RFI shielding.

¥ Silicone elastomer compression interfacial seal to provide a moisture and humidity seal between each contact and between contacts and shell.

How to Order

MIL-C-83513 ordering information- pages 240 and 241

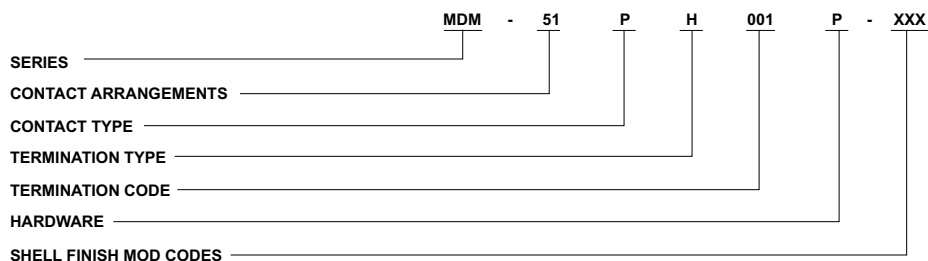

SERIES

MDM (size 9-100): Liquid Crystal Ploymer (LCP)
MDM (Combo Layout): Diallyl Phthalate insulator
Material

CONTACT ARRANGEMENTS

9-15-21-25-31-37-51-100 (standard)
7C2, 24C42 (coaxial) } or combination of
7P2, 24P4 (power) } coax and power

CONTACT TYPE

P - Pin
S - Socket

TERMINATION TYPE

H - Harness-insulated wire.
L - Solid-uninsulated wire.
S - Solder pot to accept #26 AWG MAX.
harness wire. (Not available with power
contact arrangements.)

TERMINATION CODE*

(H) 001 - 18", 7/34 strand, #26 AWG,
MIL-W-16878/4, Type E Teflon,
yellow.
(H) 003 - 18", 7/34 strand, #26 AWG,
MIL-W-16878/4, Type E Teflon,
color coded to MIL-STD-681
System I.
(L) 1 - 1/2" uninsulated solid #25
AWG gold plated copper.
(L) 2 - 1" uninsulated solid #25 AWG
gold plated copper.

HARDWARE

M - Military specification hardware, see
page 237.
P - Jackpost
K - Jackscrew-standard
L - Jackscrew-low profile

F - Float mount

B - No hardware standard
.091 (2.31) dia. hole for sizes 9-51;
.120 (3.05) dia. hole for size 100.
A - .125 (3.18) dia. mounting holes fo
sizes 9-51;
.166 (4.22) dia. hole for size 100.
B1 - .1475 (3.75) dia. hole for size 100
(Per MIL-C-83513)

SHELL FINISH MOD CODES**

No
Number - Standard Cadmium/yellow chromate
A174 - Electroless nickel
A172 - Gold over nickel
A141 - Irridite/alodine
A30 - Black anodize

*See Termination Codes page 233 for additional length
Modification codes.

**For other modifications not listed, consult the factory.

Performance and Material Specifications

STANDARD MATERIALS AND FINISHES

Shell	- Aluminum alloy per QQ-A-200/8 (6061-T6), yellow chromate/cadmium per QQ-P-416, Type II, class 3.
Insulator	- MIL-M-24519, Type GLCP-30F Glass-filled diallyl phthalate per MIL-M-14, Type SDGF
Contacts	- Copper alloy, gold plate
Mounting Hardware	- 300 Series stainless steel, passivate
Kit, Jackpost (3) items	- 300 Series stainless steel, passivate
Washer	- 400 Series stainless steel, passivate
Standard Epoxy	- Hysol EE4198 with HD3561 hardener, color green or EE4215 with HD3561, color black

MECHANICAL FEATURES

Coupling	- Friction/jackscrews
Polarization	- Keystone-shaped shells
Contact Spacing	- .050 (1.27)
Centers	
Shell Styles	- Plug and receptacle
No. of Contacts	- 9 thru 100 standard; 5 signal/2 coaxial; 5 signal/2 power. 20 signal/4 coaxial; 20 signal/4 power
Coaxial Cable	- RG - 178/U
Wire Size	- #24 thru #32 AWG
Contact Termination	- Multiple indent crimp

ELECTRICAL DATA - page 231

Standard Wire Termination Codes

Cannon Modification Code (Not MS)

The following termination codes are listed for your information. For lengths not shown, consult factory for proper modification code. All wire lengths are minimum.

Harness TYPE (H)

#26 AWG per MIL-W-16878/4, 7/34 strand, type E Teflon, stranded.

Length	All Yellow	Color Coded*
3 (76.2)	H020	H027
6 (152.4)	H019	H016
8 (203.2)	H026	H034
10 (254.0)	H029	H025
12 (304.8)	H028	H002
18 (457.2)	H001	H003
20 (508.0)	H038	H023
24 (609.6)	H009	H004
30 (762.0)	H010	H005
36 (914.4)	H011	H006
48 (1219.2)	H013	H048
72 (1828.8)	H017	H046
120 (3048.0)	H042	H041

* Cavity #1 black

Solid Uninsulated Type (L)

#25 AWG gold plated copper

Termination Code	Length
L61	.125 (3.18)
L56	.150 (3.81)
L57	.190 (4.83)
L39	.250 (6.35)
L58	.375 (9.52)
L1	.500 (12.70)
L14	.750 (19.05)
L2	1.000 (25.40)
L7	1.500 (38.10)
L6	2.000 (50.80)
L16	2.500 (63.50)
L10	3.000 (76.20)

Milimeters are in parentheses.

Contact Arrangements

(Face View of Pin insert - Use Reverse Order for Socket Side)

Standard

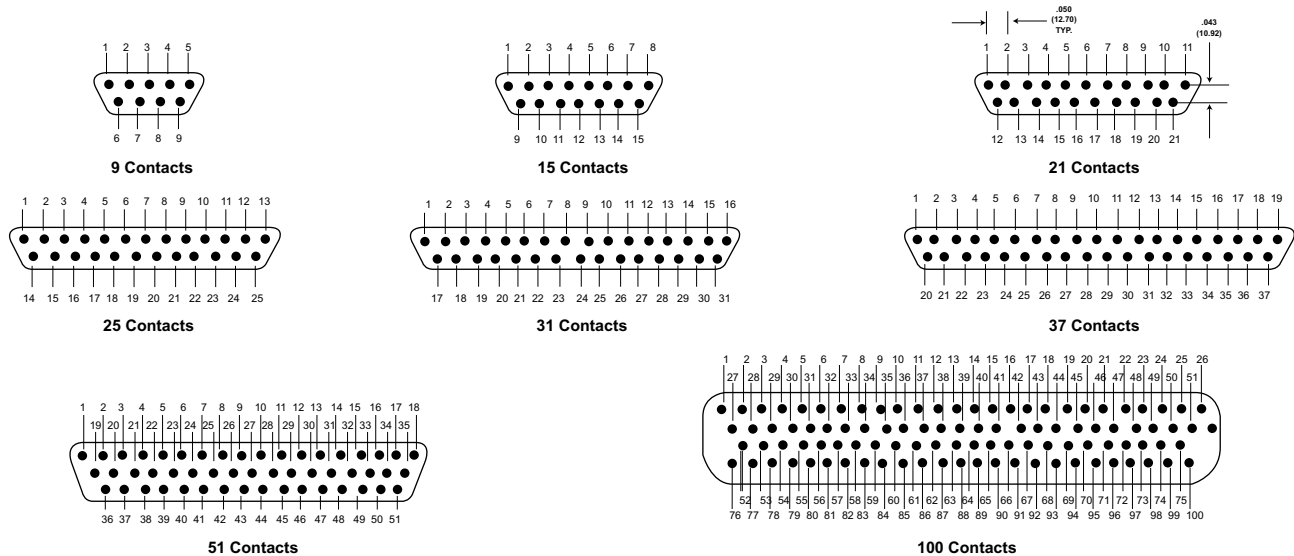

Contact identification numbers are for reference only and do not appear on insulator or connector body.

Coaxial

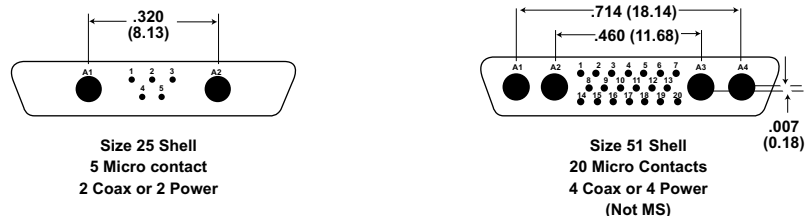

Shell Dimensions (Conforms to MIL-C-83513)

Plug

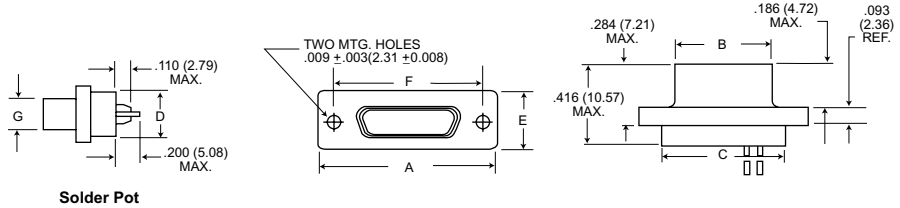

Receptacle

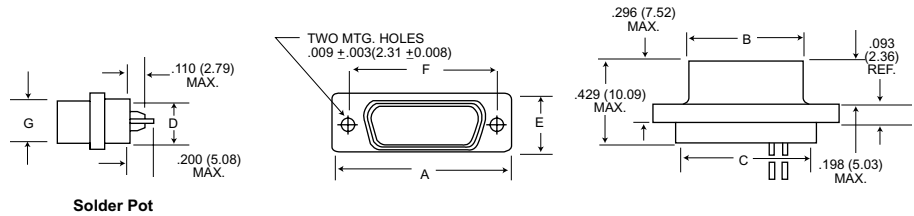

Receptacle (MDM-100 only)

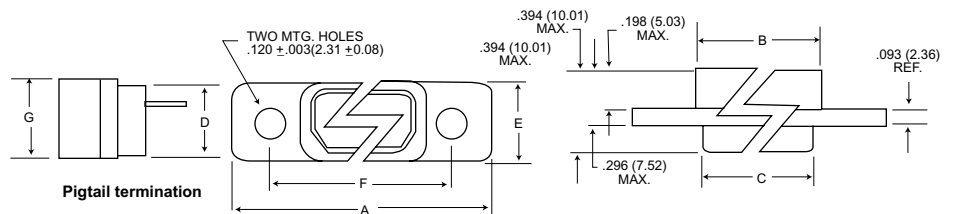

Part Number By Shell Size	A Max.	B Max.	C Max.	D Max.	E Max.	F ±.005 (0.13)	G Max.	Average Weights** oz. (gm.) ±5%
MDM-9P*	.785 (19.94)	.334 (8.48)	.400 (10.16)	.270 (6.86)	.308 (7.82)	.565 (14.35)	.185 (4.70)	.063 (1.79)
MDM-9S*	.785 (19.94)	.402 (10.21)	.400 (10.16)	.270 (6.86)	.308 (7.82)	.565 (14.35)	.253 (6.43)	.063 (1.79)
MDM-15P*	.935 (23.75)	.484 (12.29)	.550 (13.97)	.270 (6.86)	.308 (7.82)	.715 (18.16)	.185 (4.70)	.084 (2.39)
MDM-15S*	.935 (23.75)	.552 (13.97)	.550 (13.97)	.270 (6.86)	.308 (7.82)	.715 (18.16)	.253 (6.43)	.083 (2.37)
MDM-21P*	1.085 (27.56)	.634 (16.10)	.700 (17.78)	.270 (6.86)	.308 (7.82)	.865 (21.97)	.185 (4.70)	.105 (2.99)
MDM-21P*	1.085 (27.56)	.702 (17.83)	.700 (17.78)	.270 (6.86)	.308 (7.82)	.865 (21.97)	.253 (6.43)	.104 (2.97)
MDM-25P*	1.185 (30.10)	.734 (18.64)	.800 (20.32)	.270 (6.86)	.308 (7.82)	.965 (24.51)	.185 (4.70)	.119 (3.39)
MDM-25S*	1.185 (30.10)	.802 (20.37)	.800 (20.32)	.270 (6.86)	.308 (7.82)	.965 (24.51)	.253 (6.43)	.118 (3.36)
MDM-31P*	1.335 (33.91)	.884 (22.45)	.950 (24.13)	.270 (6.86)	.308 (7.82)	1.115 (28.32)	.185 (4.70)	.140 (3.99)
MDM-31S*	1.335 (33.91)	.952 (24.18)	.950 (24.13)	.270 (6.86)	.308 (7.82)	1.115 (28.32)	.253 (6.43)	.139 (3.96)
MDM-37P*	1.485 (37.72)	1.034 (26.26)	1.100 (27.94)	.270 (6.86)	.308 (7.82)	1.265 (32.13)	.185 (4.70)	.161 (4.59)
MDM-37S*	1.485 (37.72)	1.102 (27.99)	1.100 (27.94)	.270 (6.86)	.308 (7.82)	1.265 (32.13)	.253 (6.43)	.160 (4.56)
MDM-51P*	1.435 (36.45)	.984 (24.99)	1.050 (26.67)	.310 (7.87)	.351 (8.92)	1.215 (30.86)	.228 (5.79)	.193 (5.50)
MDM-51S*	1.435 (36.45)	1.052 (26.72)	1.050 (26.67)	.310 (7.87)	.351 (8.92)	1.215 (30.86)	.296 (7.52)	.188 (5.35)
MDM-100P*	2.170 (55.12)	1.384 (35.15)	1.442 (36.63)	.360 (9.14)	.394 (10.01)	1.800 (45.72)	.271 (6.88)	.500 (14.3)
MDM-100S*	2.170 (55.12)	1.508 (38.10)	1.442 (36.63)	.360 (9.14)	.394 (10.01)	1.800 (45.72)	.394 (10.01)	1.040 (29.5)

*Add lead type and length; see How To Order.

***Weight given is 1/2", uninsulated, solid, #25 AWG gold plated copper pigtailed.

Panel Mounting Dimensions (Sizes 9 - 100)

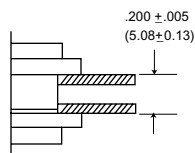

**Plug and Receptacle
Rear Mounted**

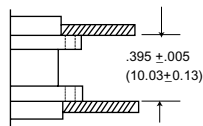

**Plug and Receptacle
Front Mounted**

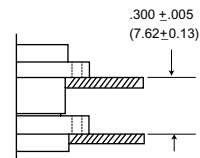

**Plug Front Mounted
Receptacle Rear Mounted**

Panel Cutouts

NOTE: See page 237 for rear panel mounting configuration.

Shell Sizes 9 thru 51

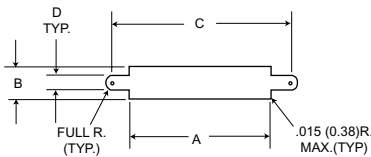

Figure 1
Front Mounting

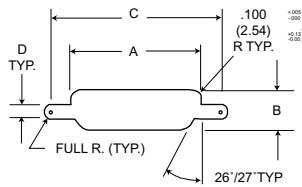

Figure 2
Rear Mounting

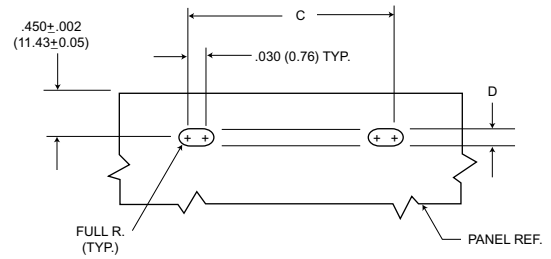

Figure 3
Edgeboard Mounting

Shell Size 100

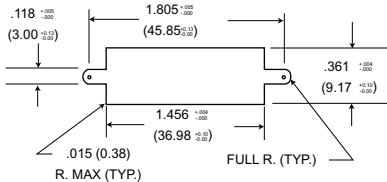

Figure 1
Front Mounting

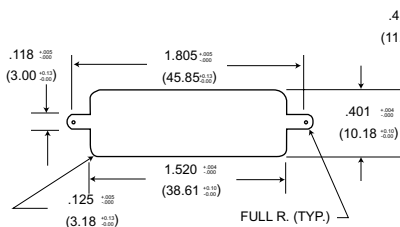

Figure 2
Rear Mounting

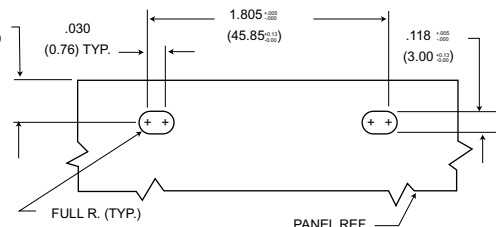

Figure 3
Edgeboard Mounting

For 9-51 Shell Sizes

NOTES:

1. Front mounting (figure 1) and rear mounting (figure 2) accommodates #2-56 screws
2. Front mounting is preferred. However, when rear mounting is necessary, use figure 2 dimensions when jackscrews are used. See detail on page 24 when jackpost are used.
3. Edgeboard mounting bracket (figure 3) uses #2-56 screws. Dimension $.450 \pm .002$ (11.43±0.05) locates the MDM receptacle flush with the end of the board.

For 100 Shell Size

NOTES:

1. Front mounting (figure 1) and rear mounting (figure 2) accommodates #4-40 screws.
2. Edgeboard mounting bracket (figure 3) uses #4-40 screws. Dimension $.450 \pm .002$ (11.43±0.05) locates the MDM receptacle flush with the end of the board.
3. Front mounting is preferred. However, when rear mounting is necessary, use figure 2 dimensions.

Shell Size	Cutout Figure	A	B	C	D
		+0.004 (0.10) -0.000 (0.00)	+0.004 (0.10) -0.000 (0.00)	+0.005 (0.13) -0.000 (0.00)	+0.005 (0.13) -0.000 (0.00)
9	1	.408 (10.36)	.271 (6.88)	.570 (14.48)	.089 (2.26)
	2	.401 (10.19)	.252 (6.40)	.570 (14.48)	.089 (2.26)
	3	-	-	.570 (14.48)	.089 (2.26)
15	1	.558 (14.17)	.271 (6.88)	.720 (18.29)	.089 (2.26)
	2	.551 (14.00)	.252 (6.40)	.720 (18.29)	.089 (2.26)
	3	-	-	.720 (18.29)	.089 (2.26)
21	1	.708 (17.98)	.271 (6.88)	.870 (22.10)	.089 (2.26)
	2	.701 (17.81)	.252 (6.40)	.870 (22.10)	.089 (2.26)
	3	-	-	.870 (22.10)	.089 (2.26)
25	1	.808 (20.52)	.271 (6.88)	.970 (24.64)	.089 (2.26)
	2	.801 (20.34)	.252 (6.40)	.970 (24.64)	.089 (2.26)
	3	-	-	.970 (24.64)	.089 (2.26)
31	1	.958 (24.33)	.271 (6.88)	1.120 (28.45)	.089 (2.26)
	2	.951 (24.16)	.252 (6.40)	1.120 (28.45)	.089 (2.26)
	3	-	-	1.120 (28.48)	.089 (2.26)
37	1	1.108 (28.14)	.271 (6.88)	1.270 (32.26)	.089 (2.26)
	2	1.101 (27.97)	.252 (6.40)	1.270 (32.26)	.089 (2.26)
	3	-	-	1.270 (32.26)	.089 (2.26)
51	1	1.058 (26.87)	.315 (8.00)	1.220 (30.99)	.089 (2.26)
	2	1.051 (26.70)	.295 (7.49)	1.220 (30.99)	.089 (2.26)
	3	-	-	1.220 (30.99)	.089 (2.26)

Mounting Hardware Views (for sizes 9-51)

This hardware supplied unassembled.

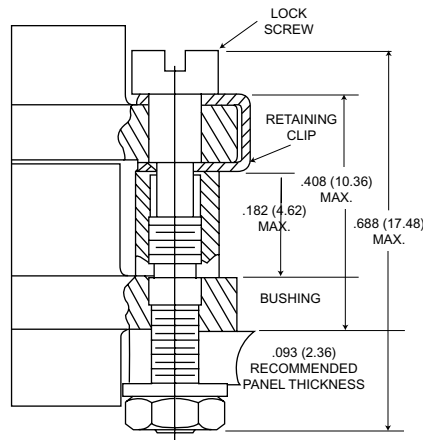
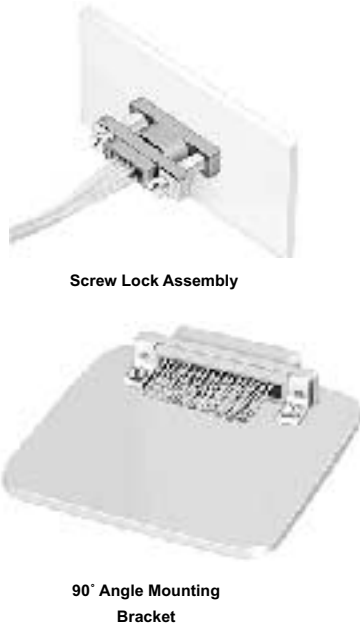

Screw Lock Assembly*
*NOTE Torque value is 2.5 in/lbs max.

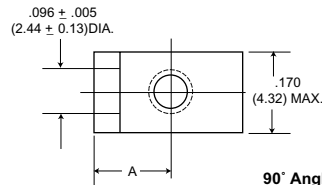

90° Angle Mounting Bracket

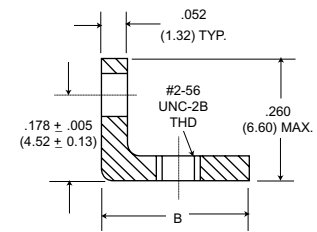
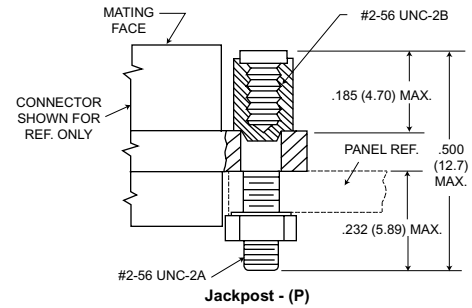

Description	Part Number	A ±.005 (±0.13)	B Max.
Screw Lock Assembly	322-9500-000		N/A
Jackpost kit	320-9505-000		N/A
Mounting Bracket 90° MDM for 9 thru 37 Shell Sizes	015-9516-002	.147 (3.73)	.308 (7.82)
Mounting Bracket 90° MDM fo 51 Shell Size	015-9516-003	.169 (4.29)	.350 (8.89)

NOTES: Screw lock assembly (322-9500-000) can be used for front mounting only. Jackpot kit (320-9505-000) consists of two assemblies, shipped unassembled.

Jackpost Bushing (for rear panel mounting-for sizes 9-51)

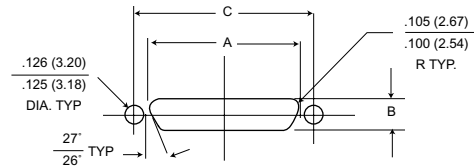
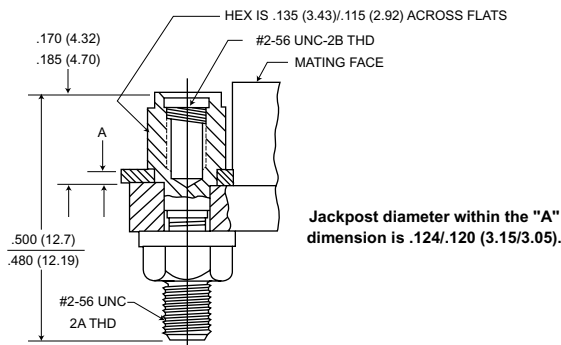

Plug and Rectacle Dimensions

Shell Size	A +.004 (0.10) -.000 (0.00)	B +.004 (0.10) -.000 (0.00)	C ±.005 (0.13)
9	.401 (10.19)	.252 (6.40)	.565 (14.35)
15	.551 (14.00)	.252 (6.40)	.715 (18.16)
21	.701 (17.81)	.252 (6.40)	.865 (21.97)
25	.801 (20.34)	.252 (6.40)	.965 (24.51)
31	.951 (24.16)	.252 (6.40)	1.115 (28.34)
37	1.101 (27.97)	.252 (6.40)	1.265 (32.13)
51	1.051 (26.70)	.295 (7.49)	1.215 (30.86)

Panel A Thickness	A +.005 (0.13) -.000 (0.00)	Jackpost Kit Number*
3/32 (2.4)	.087 (2.21)	320-9505-007
1/16 (1.6)	.056 (1.42)	320-9505-006
3/64 (1.2)	.042 (1.07)	320-9505-005
1/32 (0.8)	.025 (0.64)	320-9505-004

*A kit consists of 2 jackpost, 2 nuts, 2 washers.

Mounting Hardware Views (sizes 9-51)

This hardware is factory installed.

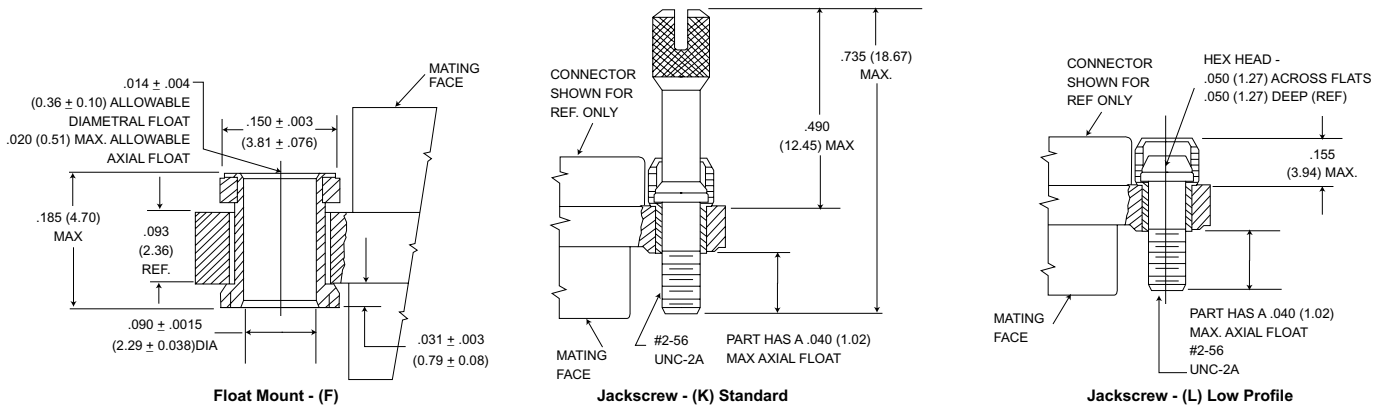

Shown here is a cutaway view of the float mount for the MD connector. The basic shell dimensions are the same for the float mount and the screw mounting hole configurations. View shown is for standard float mount front panel mounting. Reverse mounting is available on request.

* NOTE: Torque vales are as follows:
 Low Profile Jackscrew (L)-2.5 in/lbs
 Standard Jackscrew (K)-2.5 in/lbs

Repair kit available-consult factory.

Mounting Hardware to Military Specification (for sizes 9 - 100) per MIL-C-83513/5

This hardware supplied in kits unassembled (2 pieces of each item).

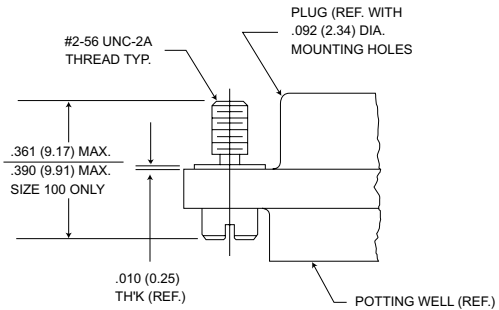
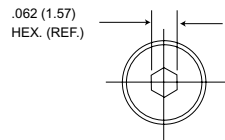

Figure 1. Jackscrew - Low profile Slotted Head Size 9-51 Size 100*



Allen head Optional Head Configuration Plug and Receptacle Low and High Profile Size 9-51 Size 100* (same dimensions)

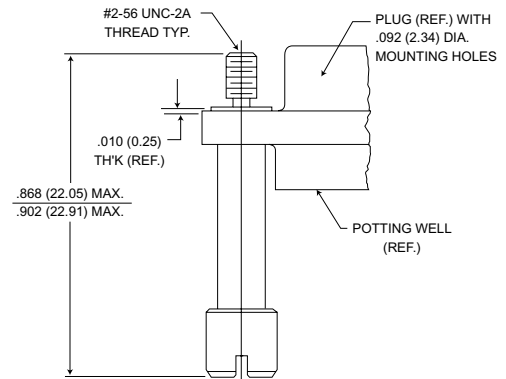

Figure 2. Jackscrew - High Profile Slotted Head Size 9-51 Size 100*

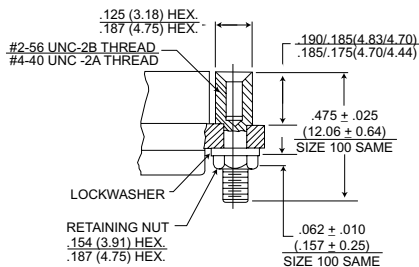

Figure 3. Jackpost Assembly Size 9-51 Size 100*

To order hardware kits separately, order either by M83513/5-** or by 320-950X-XXX.

Description	Size 9-51		Size 100*	
	Mod Code	Part Number	Mod Code	Part Number
Slotted Head Jackscrew Assy Low Profile (Figure 1)	M5	320-9508-025	05	M15 320-9508-021
Slotted Head Jackscrew Assy Low Profile (Figure 2)	M6	320-9508-027	06	M16 320-9508-023
Allen Head Jackscrew Assy Low Profile (Figure 1)	M2	320-9508-026	02	M12 320-9508-022
Allen Head Jackscrew Assy High Profile (Figure 2)	M3	320-9508-028	03	M13 320-9508-024
Jackpost Assy (Figure 3)	M7	320-9505-033	07	M17 320-9505-030

*Size 100 requires B1 size mounting holes.

Mounting Hardware Views (for size 100)

This hardware supplied unassembled.



90° Angle Mounting Bracket

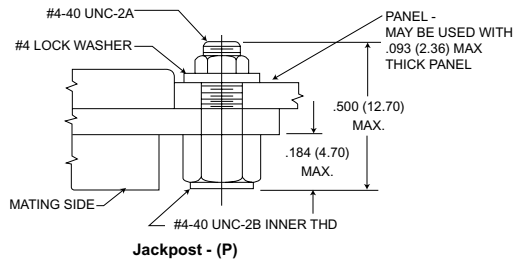

Jackpost - (P)

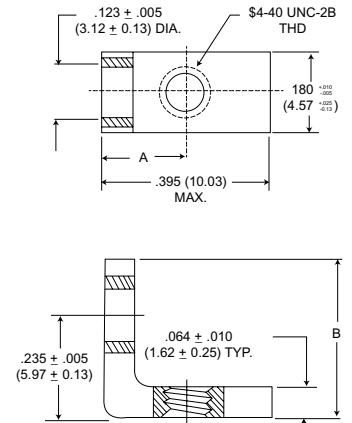

90° Angle Mounting Bracket

Description	Part Number	A ± .005 (0.13)	B Max.
Jackpost kit	320-9505-015	N/A	
Mounting Bracket 90° MDM	015-9528-000	.191 (4.85)	.370 (9.40)

This hardware is factory installed.

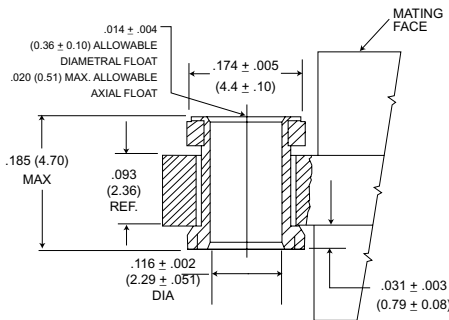

Float Mount - (F) Std.

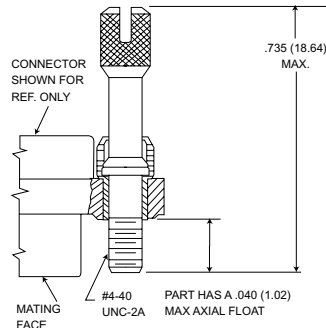

Jackscrew - (K) Standard

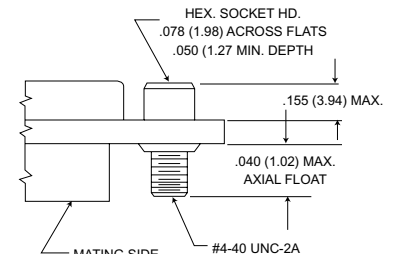

Jackscrew - (L) (Low Profile)

*NOTE: Torque vales are as follows:
 Low Profile Jackscrew (L)-4.0 in/lbs
 Standard Jackscrew (K)-4.0 in/lbs

Jackpost Bushing (for Rear Panel Mounting)

Panel Thickness	A + .005 (0.13) - .000 (0.00)	Jackpost Kit Number*
3/32 (2.4)	.087 (2.21)	320-9505-013
1/16 (1.6)	.058 (1.42)	320-9505-012
1/32 (0.8)	.025 (0.64)	320-9505-010
3/64 (1.2)	.042 (1.07)	320-9505-011

*2 jackposts, 2 nuts, 2 washers

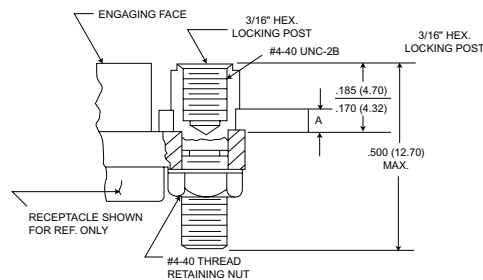

Dimensions for Rear Panel Mounting

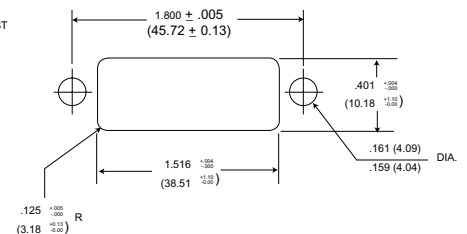

Connector Saver

Save wear and tear on your equipment and systems connectors by using the "Connector Saver".

The multi-matings and unmatings experienced by most connectors during testing and final check out can be eliminated.



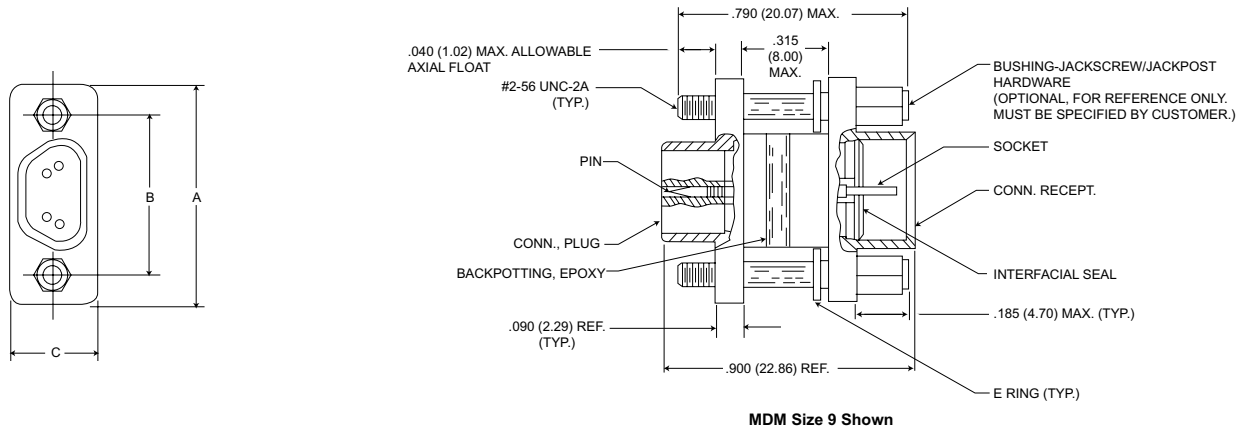











Simply mate the "Connectors Saver" to your unit and use the opposite side for your testing interface... less wear, less tear, less chance of damage. It is available in all seven standard MDM layouts. Mating hardware is available and can be ordered either separately or included with the connector saver.



Size	A174 Electroless Nickel		Cadmium Plated		*Hardware Kits	A Max.	B ± .005 (0.13)	C Max.
	With Hardware	W/O Hardware	With Hardware	W/O Hardware				
9	MDM98479-86	MDM98479-18	MDM98479-78	MDM-97294-371	320-9505-014**	.785 (19.94)	.565 (14.35)	.308 (7.82)
15	MDM98479-87	MDM98479-19	MDM98479-79	MDM-97294-372	320-9505-014**	.935 (23.75)	.715 (18.16)	.308 (7.82)
21	MDM98479-88	MDM98479-20	MDM98479-80	MDM-97294-373	320-9505-014**	1.085 (27.56)	.865 (21.97)	.308 (7.82)
25	MDM98479-89	MDM98479-21	MDM98479-81	MDM-97294-374	320-9505-014**	1.185 (30.10)	.965 (24.51)	.308 (7.82)
31	MDM98479-90	MDM98479-14	MDM98479-82	MDM-97294-375	320-9505-014**	1.335 (33.91)	1.115 (28.32)	.308 (7.82)
37	MDM98479-91	MDM98479-15	MDM98479-83	MDM-97294-376	320-9505-014**	1.485 (37.72)	1.265 (32.13)	.308 (7.82)
51	MDM98479-92	MDM98479-16	MDM98479-84	MDM-97294-377	320-9505-014**	1.435 (36.45)	1.215 (30.86)	.351 (8.91)
100	MDM98479-93	MDM98479-17	MDM98479-85	MDM-97294-717	320-9508-014***	2.170 (55.12)	1.800 (45.72)	.394 (10.01)

* Kit contains 2 bushings-jackpost/jackscrew and 2 E rings.
 ** Size 9-51-#2-56 UNC2B Thread
 *** Size 100-#4-40 UNC2B Thread

How to Order - ITT Cannon Part Number Nomenclature to MIL-C-83513

	MD**	01	-	H100	-	**	****
ITT CANNON SERIES							
MDM	-	Metal Shell, Liquid Crystal Polymer (LCP)					
MDB	-	Diallyl Phthalate Insulator					
MDVB	-	Polyester Insulator					
MIL-C-83513 SLASH SHEET							
01	-	Plug, Connector, Solderpot					
02	-	Receptacle, Connector, Solderpot					
03	-	Plug, Connector, Crimp Type					
04	-	Receptacle, Connector, Crimp Type					
05	-	Hardware Only 					
06	-	Plug, Connector, Solderpot					
07	-	Receptacle, Connector, Solderpot					
08	-	Plug, Connector, Crimp Type					
09	-	Receptacle, Connector, Crimp Type					
INSERT ARRANGEMENT							
		<u>METAL SHELL</u>		<u>PLASTIC</u>			
A9	-	9 Contact		9 Contact			
B15	-	15 Contact		15 Contact			
C21	-	21 Contact		21 Contact			
D25	-	25 Contact		25 Contact			
E31	-	31 Contact		31 Contact			
F37	-	37 Contact		37 Contact			
G51	-	51 Contact		51 Contact			
H100	-	100 Contact					
WIRE TYPE							
No Number - For Solderpot							
01	-	18"	long, #26 AWG per MIL-W-22759/11-26-9				
02	-	36"	long, #26 AWG per MIL-W-22759/11-26-9				
03	-	18"	long, #26 AWG per MIL-W-22759/11-26				
			Color Coded per MIL-STD-681, System 1				
04	-	36"	long, #26 AWG per MIL-W-22759/11-26-				
			Color Coded per MIL-STD-681, System 1				
05	-	.5"	long, #25 AWG, type S per QQ-W-343,				
			Gold Plated				
06	-	1.0"	long, #25 AWG, type S per QQ-W-343,				
			Gold Plated				
07	-	.5"	long, #25 AWG, type S per QQ-W-W-343,				
			Tin Plated				
08	-	1.0"	long, #25 AWG, type S per QQ-W-343,				
			Tin Plated				
09	-	18"	long, #26 AWG per MIL-W-22759/33-26-9				
10	-	36"	long, #26 AWG per MIL-W-22759/33-26-9				
11	-	18"	long, #26 AWG per MIL-W-22759/33-26				
			Color Coded per MIL-STD-681, System 1				
12	-	36"	long, #26 AWG per MIL-W-22759/33-26				
			Color Coded per MIL-STD-681, System 1				
13	-	72"	long, #26 AWG per MIL-W-22759/11-26-9				
14	-	72"	long, #26 AWG per MIL-W-22759/11-26				
			Color Coded per MIL-STD-681, System 1				
15	-	72"	long, #26 AWG per MIL-W-22759/33-26-9				
16	-	72"	long, #26 AWG per MIL-W-22759/33-26				
			Color Coded per MIL-STD-681, System 1				
							
SHELL FINISH							
No number - for plastic type connector							
No number - for Cadmium							
A174	-	Electroless Nickel 					

NOTES:

(Specify when ordering, if necessary.)

 - For every Mil-Spec P/N, ITT has one corresponding part numbers.
Example: ITT P/N's MDM01-A9

2 - Tolerance on wire lengths-18", 36" and 72" long,
+1.00"/-0.00"
.5" and 1.00" + .200"/-.000"

 - For space application, connector shell finish must be "A174" and wire must be per MIL-W-22759/33-26.

4 - Any deviations to these P/N's will result in assignment of a special P/N, consult factory.

 - No size 100 in plastic type connector.

 - Color coding in accordance with MIL-STD-681, System 1 except the appropriate color code is the individual contact cavity number minus 1 for contact positions.

 - For mounting hardware to Military Specification (sizes 9 to 100) see page 238.



Qualification to slash sheets 10 thru 27 for the PCB connector will be announced when completed.

How to Order - MIL-C-83513 Part Number Nomenclature

M83513/ - 01 - A ** C

SERIES
Connector, Electrical, Rectangular
Microminiature, Polarized Shell













MIL-C-83513 SLASH SHEET

- | | |
|--|---|
| 01 - Plug, Connector, Solderpot | } Metal Shell |
| 02 - Receptacle, Connector, Solderpot | |
| 03 - Plug, Connector, Crimp Type | |
| 04 - Receptacle, Connector, Crimp Type | |
| 05 - Hardware Only  | |
| 06 - Plug, Connector, Solderpot | } Plastic  |
| 07 - Receptacle, Connector, Solderpot | |
| 08 - Plug, Connector, Crimp Type | |
| 09 - Receptacle, Connector, Crimp Type | |

INSERT ARRANGEMENT

	<u>METAL SHELL</u>	<u>PLASTIC</u>
A -	9 Contact	9 Contact
B -	15 Contact	15 Contact
C -	21 Contact	21 Contact
D -	25 Contact	25 Contact
E -	31 Contact	31 Contact
F -	37 Contact	37 Contact
G -	51 Contact	51 Contact
H -	100 Contact	

WIRE TYPE

- No Number - For Solderpot
- | | | |
|------|--|---|
| 01 - | 18" long, #26 AWG per MIL-W-22759/11-26-9 | |
| 02 - | 36" long, #26 AWG per MIL-W-22759/11-26-9 | |
| 03 - | 18" long, #26 AWG per MIL-W-22759/11-26-9
Color Coded per MIL-STD-681, System 1 |  |
| 04 - | 36" long, #26 AWG per MIL-W-22759/11-26-9
Color Coded per MIL-STD-681, System 1 |  |
| 05 - | .5" long, #25 AWG, type S per QQ-W-343,
Gold Plated | |
| 06 - | 1.0" long, #25 AWG, type S per QQ-W-343,
Gold Plated | |
| 07 - | .5" long, #25 AWG, type S per QQ-W-W-343,
Tin Plated | |
| 08 - | 1.0" long, #25 AWG, type S per QQ-W-343,
Tin Plated | |
| 09 - | 18" long, #26 AWG per MIL-W-22759/33-26-9 |  |
| 10 - | 36" long, #26 AWG per MIL-W-22759/33-26-9 |  |
| 11 - | 18" long, #26 AWG per MIL-W-22759/33-26-9
Color Coded per MIL-STD-681, System 1 |   |
| 12 - | 36" long, #26 AWG per MIL-W-22759/33-26-9
Color Coded per MIL-STD-681, System 1 |   |
| 13 - | 72" long, #26 AWG per MIL-W-22759/11-26-9 | |
| 14 - | 72" long, #26 AWG per MIL-W-22759/11-26-9
Color Coded per MIL-STD-681, System 1 |  |
| 15 - | 72" long, #26 AWG per MIL-W-22759/33-26-9 |  |
| 16 - | 72" long, #26 AWG per MIL-W-22759/33-26-9
Color Coded per MIL-STD-681, System 1 |   |

NOTES:

(Specify when ordering, if necessary.)

 - For every Mil-Spec P/N, ITT has one corresponding part numbers.
Example: ITT P/N's MDM01-A9

2 - Tolerance on wire lengths-18", 36" and 72" long,
+1.00"/-0.00"
.5" and 1.00" + .200"/-.000"

 - For space application, connector shell finish must be "N" and wire must be per MIL-W-22759/33-26.

4 - Any deviations to these P/N's will result in assignment of a special P/N, consult factory.

 - No size 100 in plastic type connector.

 - Color coding in accordance with MIL-STD-681, System 1 except the appropriate color code is the individual contact cavity number minus 1 for contact positions.

 - For mounting hardware to Military Specification (sizes 9 to 100) see page 238.

SHELL FINISH

- No letter - for plastic type connector
C - Cadmium
N - Electroless Nickel 

Qualification to slash sheets 10 thru 27 for the PCB connectors will be announced when completed.



MDM-PCB connectors are designed for use with flex circuitry, flat cable and printed circuit boards or multi-layer boards. They use the standard MDM metal shell and provide high density and high reliability in board-to-board, board-to-cable and cable-to-cable applications.

MDM-PCB connectors are available in 8 shell sizes with 9 to 100 contacts. Terminations may be straight (BS) or at 90° (BR, CBR) board thickness. Jackpost mounting for use with locking hardware is also available.

How to Order - MDM-PCB Series

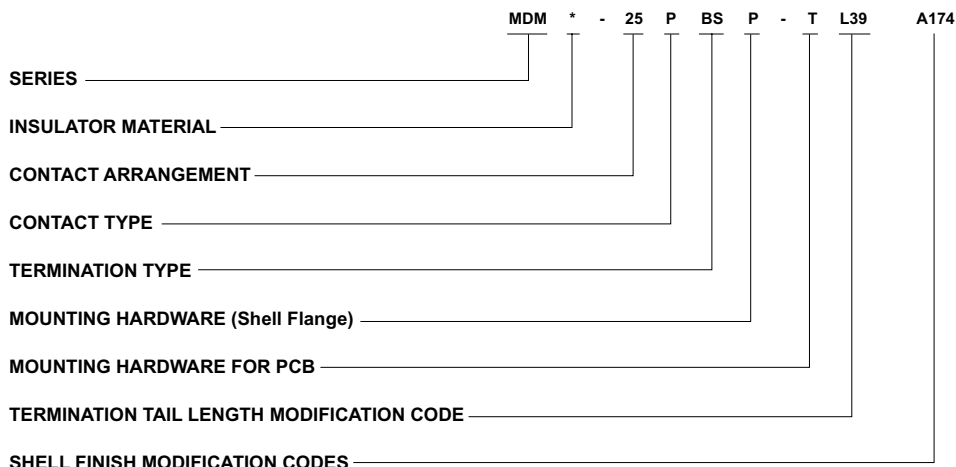

SERIES

MDM - Microm "D" Metal Shell

INSULATOR MATERIAL

Liquid Crystal Polymer (LCP)

CONTACT ARRANGEMENT

9, 15, 21, 25, 31, 37, 51, and 100
Size 100 not available in "BR"

CONTACT TYPE

P - Pin (Plug)
S - Socket (Receptacle)

TERMINATION TYPE

BS - Straight PCB Termination
BR - 90° PCB Termination
CBR - 90° Narrow Profile PCB Terminations

MOUNTING HARDWARE (Shell Flange)

P - Jackposts
M7 - Jackposts
M83513/5-07 (Sizes 9-51)
M17 - Jackposts
M83513/5-17 (Size 100)
No letter - none

MOUNTING HARDWARE FOR PCB

T - Threaded Insert
#2-56 Thd for Shell Sizes 9 thru 51
#4-40 Thd for Shell Size 100
No letter - none

TERMINATION TAIL LENGTH MODIFICATION CODE

None - .109 (2.77) ±.015 (0.38) Standard
L61 - .125 (3.18)
L56 - .150 (3.81)
L57 - .190 (4.83)
L39 - .250 (6.35)
L58 - .375 (9.52)

SHELL FINISH MODIFICATION CODES

None - Yellow Chromate/Cadmium over Nickel
A174 - Electroless Nickel
A172 - Gold over Nickel
A141 - Iridite/Alodine
A30 - Black Anodize
(For special modification codes, consult factory.)

NOTE: Back molding material - Epoxy Hysol #MG40FS

BS (Board Straight) Series

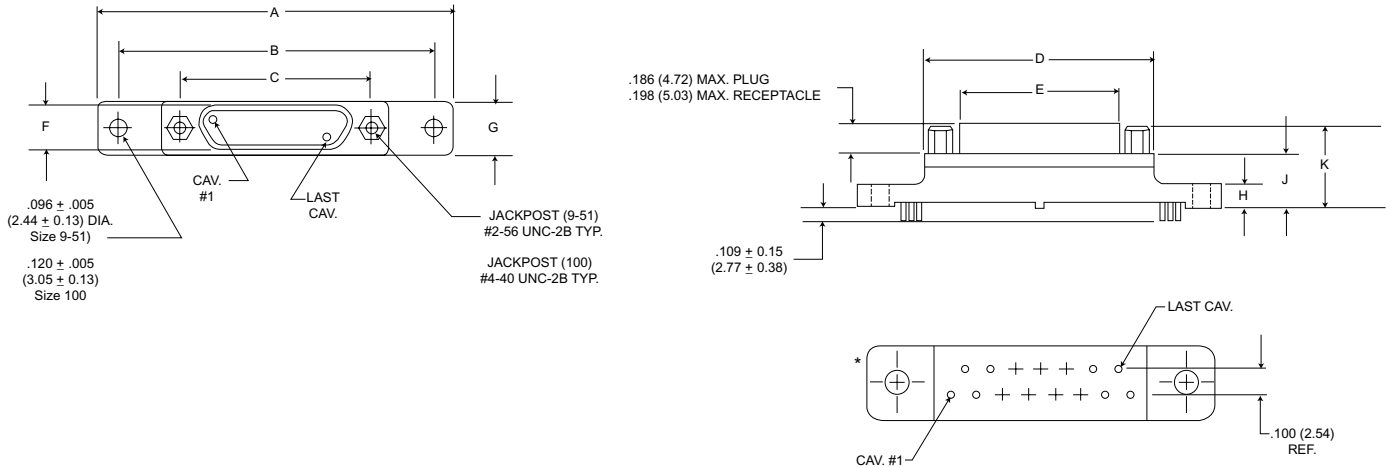

PCB Termination Arrangements* (Viewed from PCB solder side)

Identification number shown for plug connector, use reverse order for socket connector.

NOTE: Dimensions shown are for reference only-consult factory for final design dimensions.

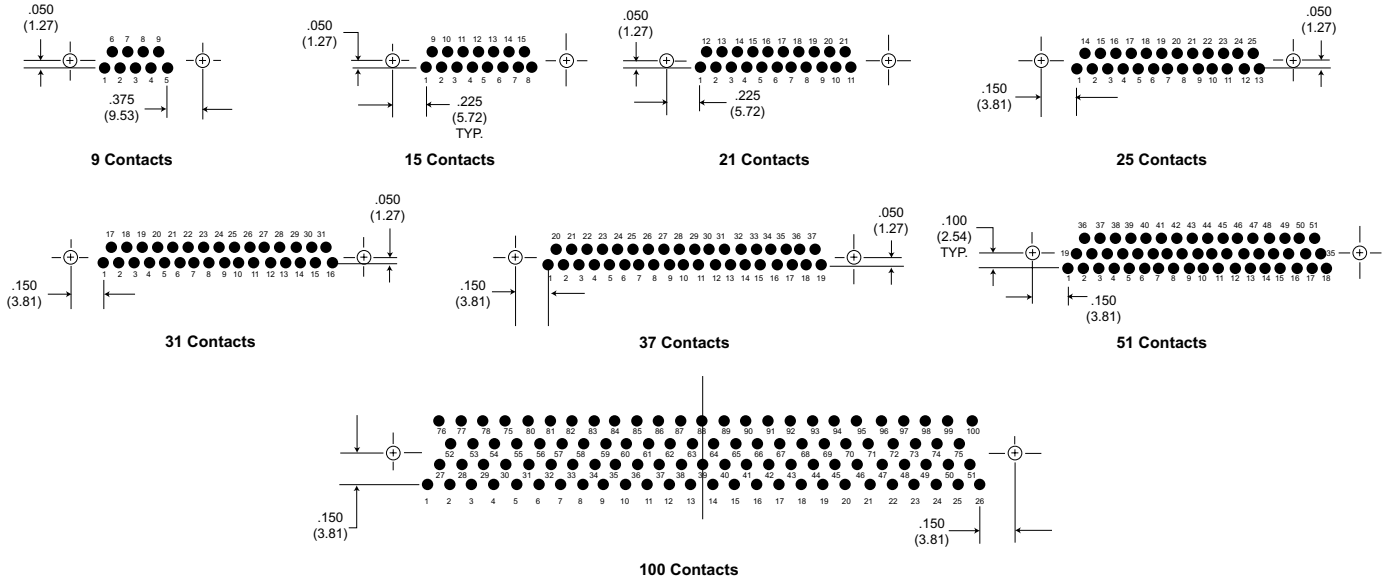

NOTE: Standard lead termination is #24 AWG, solid copper, solder or tin dipped

All Termination Configurations .100 (2.54) x .100 (2.54) Grid Pattern, Offset .050 (1.27)

Part Number By Shell Size	A	B	C	D	E	F	G	H	J	K
	Max.	±.007 (.018)	±.005 (.013)	Max.	Max.	Max.	Max.	Max.	Max.	Max.
MDM-9PBS*	1.390 (35.31)	1.150 (29.21)	.565 (14.35)	.785 (19.94)	.334 (8.48)	.185 (4.70)	.308 (7.82)	.165 (4.19)	.355 (9.02)	.555 (14.10)
MDM-9SBS*	1.390 (35.31)	1.150 (29.21)	.565 (14.35)	.785 (19.94)	.402 (10.21)	.253 (6.43)	.308 (7.82)	.165 (4.19)	.355 (9.02)	.555 (14.10)
MDM-15PBS*	1.390 (35.31)	1.150 (29.21)	.715 (18.16)	.935 (23.75)	.484 (12.29)	.185 (4.70)	.308 (7.82)	.165 (4.19)	.355 (9.02)	.555 (14.10)
MDM-15SBS*	1.390 (35.31)	1.150 (29.21)	.715 (18.16)	.935 (23.75)	.552 (13.97)	.253 (6.43)	.308 (7.82)	.165 (4.19)	.355 (9.02)	.555 (14.10)
MDM-21PBS*	1.690 (43.93)	1.450 (36.83)	.865 (21.97)	1.085 (27.56)	.634 (16.10)	.185 (4.70)	.308 (7.82)	.165 (4.19)	.355 (9.02)	.555 (14.10)
MDM-21SBS*	1.690 (43.93)	1.450 (36.83)	.865 (21.97)	1.085 (27.56)	.702 (17.83)	.253 (6.43)	.308 (7.82)	.165 (4.19)	.355 (9.02)	.555 (14.10)
MDM-25PBS	1.740 (44.20)	1.500 (38.10)	.965 (24.51)	1.185 (30.10)	.734 (18.64)	.185 (4.70)	.308 (7.82)	.165 (4.19)	.355 (9.02)	.555 (14.10)
MDM-25SBS*	1.740 (44.20)	1.500 (38.10)	.965 (24.51)	1.185 (30.10)	.802 (20.37)	.253 (6.43)	.308 (7.82)	.165 (4.19)	.355 (9.02)	.555 (14.10)
MDM-31PBS*	2.040 (51.82)	1.800 (45.72)	1.115 (28.32)	1.335 (33.91)	.884 (22.45)	.185 (4.70)	.308 (7.82)	.165 (4.19)	.355 (9.02)	.555 (14.10)
MDM-31SBS*	2.040 (51.82)	1.800 (45.72)	1.115 (28.32)	1.335 (33.91)	.952 (24.18)	.253 (6.43)	.308 (7.82)	.165 (4.19)	.355 (9.02)	.555 (14.10)
MDM-37PBS*	2.340 (59.44)	2.100 (53.34)	1.265 (32.13)	1.485 (37.72)	1.034 (26.26)	.185 (4.70)	.308 (7.82)	.165 (4.19)	.355 (9.02)	.555 (14.10)
MDM-37SBS*	2.340 (59.44)	2.100 (53.34)	1.265 (32.13)	1.485 (37.72)	1.102 (27.99)	.253 (6.43)	.308 (7.82)	.165 (4.19)	.355 (9.02)	.555 (14.10)
MDM-51PBS*	2.270 (67.66)	2.000 (50.80)	1.215 (30.86)	1.435 (36.45)	.984 (24.99)	.228 (5.79)	.351 (8.92)	.165 (4.19)	.355 (9.02)	.555 (14.10)
MDM-51SBS*	2.270 (67.66)	2.000 (50.80)	1.215 (30.86)	1.435 (36.45)	1.052 (26.72)	.296 (7.52)	.351 (8.92)	.165 (4.19)	.355 (9.02)	.555 (14.10)
MDM-100PBS*	3.070 (77.98)	2.800 (71.12)	1.800 (45.72)	2.175 (55.24)	1.384 (35.15)	.271 (6.88)	.460 (11.68)	.303 (7.70)	.550 (12.70)	.686 (17.42)
MDM-100SBS*	3.070 (77.98)	2.800 (71.12)	1.800 (45.72)	2.175 (55.24)	1.508 (38.30)	.394 (10.01)	.460 (11.68)	.303 (7.70)	.550 (12.70)	.686 (17.75)

*For jackpost, add letter "P" or "M7" for sizes 9-51, "M17" for size 100.

BR (Board Right Angle) Series

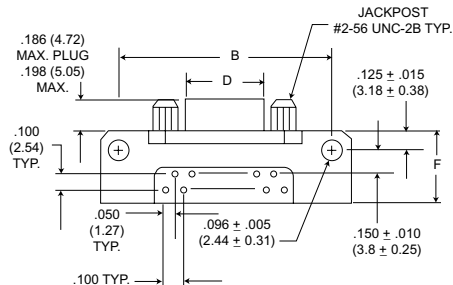
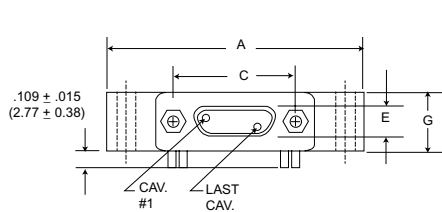

PCB Termination Arrangements (Viewed from bottom of connector, PCB solder side.)

Identification number shown for plug connector, use reverse order for socket connector.

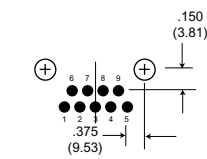

9 Contacts

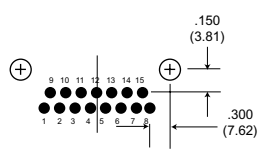

15 Contacts

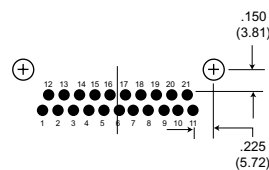

21 Contacts

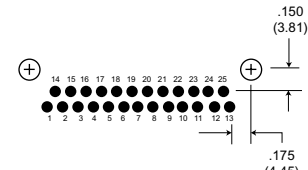

25 Contacts

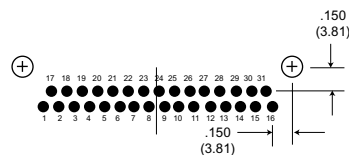

31 Contacts

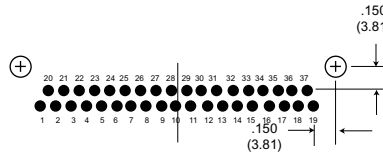

37 Contacts

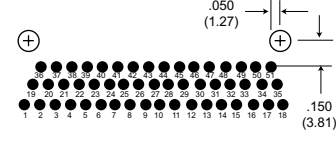

51 Contacts

NOTE: Standard lead termination is #24 AWG, gold plated, solid copper, solder or tin dripped.

All Termination Configurations .100 (2.54) x .100 (2.54) Grid Pattern, Offset .050 (1.27).

Part Number By Shell Size	A Max.	B ± .007 (.018)	C ± .005 (.013)	D Max.	E Max.	F Max.	G Max.
MDM-9PBR*	1.390 (35.31)	1.150 (29.21)	.565 (14.35)	.334 (8.48)	.185 (4.70)	.455 (11.56)	.308 (7.82)
MDM-9SBR*	1.390 (35.31)	1.150 (29.21)	.565 (14.35)	.402 (10.21)	.253 (6.43)	.455 (11.56)	.308 (7.82)
MDM-15PBR*	1.540 (39.12)	1.300 (33.02)	.715 (18.16)	.484 (12.29)	.185 (4.70)	.455 (11.56)	.308 (7.82)
MDM-15SBR*	1.540 (39.12)	1.300 (33.02)	.715 (18.16)	.552 (13.97)	.253 (6.43)	.455 (11.56)	.308 (7.82)
MDM-21PBR*	1.690 (42.93)	1.450 (36.83)	.865 (21.97)	.634 (16.10)	.185 (4.70)	.455 (11.56)	.308 (7.82)
MDM-21SBR*	1.690 (42.93)	1.450 (36.83)	.865 (21.97)	.702 (17.83)	.253 (6.43)	.455 (11.56)	.308 (7.82)
MDM-25PBR*	1.790 (45.47)	1.550 (39.37)	.965 (24.51)	.734 (18.64)	.185 (4.70)	.455 (11.56)	.308 (7.82)
MDM-25SBR*	1.790 (45.47)	1.550 (39.37)	.965 (24.51)	.802 (20.37)	.253 (6.43)	.455 (11.56)	.308 (7.82)
MDM-31PBR*	2.040 (51.82)	1.800 (45.72)	1.115 (28.32)	.884 (22.45)	.185 (4.70)	.455 (11.56)	.308 (7.82)
MDM-31SBR*	2.040 (51.82)	1.800 (45.72)	1.115 (28.32)	.952 (24.18)	.253 (6.43)	.455 (11.56)	.308 (7.82)
MDM-37PBR*	2.340 (59.44)	2.100 (53.34)	1.265 (32.13)	1.034 (26.26)	.185 (4.70)	.455 (11.56)	.308 (7.82)
MDM-37SBR*	2.340 (59.44)	2.100 (53.34)	1.265 (32.13)	1.102 (27.99)	.253 (6.43)	.455 (11.56)	.308 (7.82)
MDM-51PBR*	1.875 (47.63)	1.600 (40.64)	1.215 (30.86)	.984 (24.99)	.228 (5.79)	.565 (14.35)	.351 (8.92)
MDM-51SBR*	1.875 (47.63)	1.600 (40.64)	1.215 (30.86)	1.052 (26.72)	.296 (7.52)	.565 (14.35)	.351 (8.92)

*For jackpost, add letter "P" or "M" for sizes 9-51, "M17" for size 100.

CBR (Condensed Board Right Angle) Series

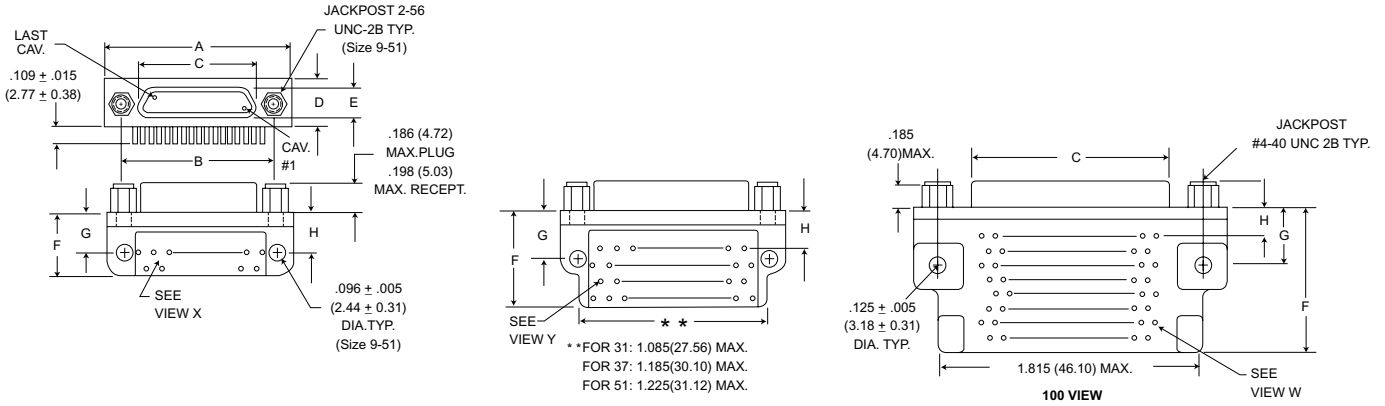

PCB Termination Arrangements (Viewed from bottom of connector, PCB solder side.)

Identification number shown for plug connector, use reverse order for socket connector.

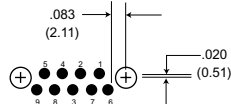

9 Contacts
View X

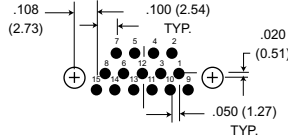

15 Contacts
View X

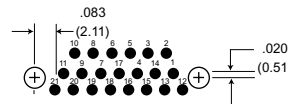

21 Contacts
View X

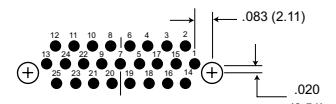

25 Contacts
View X

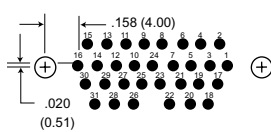

31 Contacts
View Y

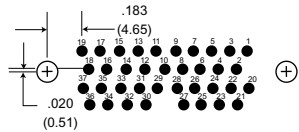

37 Contacts
View Y

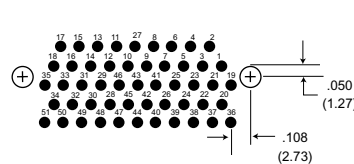

51 Contacts
View Y

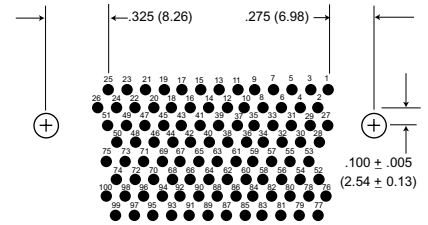

100 Contacts
View W

All Termination Configurations .100 (2.54) x .100 (2.54) Grid Pattern, Offset .050 (1.27).

NOTE: Standard lead termination is #24 AWG, solid copper, solder or tin dripped.

Part Number By Shell Size	A Max.	B ± .005 (.013)	C Max.	D Max.	E Max.	F Max.	G ± .010 (.025)	H ± .010 (.025)
MDM-9PCBR*	.785 (19.94)	.565 (14.35)	.334 (8.48)	.308 (7.82)	.185 (4.70)	.420 (10.67)	.250 (6.35)	.230 (5.81)
MDM-9SCBR*	.785 (19.94)	.565 (14.35)	.402 (10.21)	.308 (7.82)	.253 (6.43)	.420 (10.67)	.250 (6.35)	.230 (5.81)
MDM-15PCBR*	.935 (23.75)	.715 (18.16)	.484 (12.29)	.308 (7.82)	.185 (4.70)	.420 (10.67)	.250 (6.35)	.130 (3.30)
MDM-15SCBR*	.935 (23.75)	.715 (18.16)	.552 (13.97)	.308 (7.82)	.253 (6.43)	.420 (10.67)	.250 (6.35)	.130 (3.30)
MDM-21PCBR*	1.085 (27.56)	.865 (21.97)	.634 (16.10)	.308 (7.82)	.185 (4.70)	.420 (10.67)	.250 (6.35)	.130 (3.30)
MDM-21SCBR*	1.085 (27.56)	.865 (21.97)	.702 (17.83)	.308 (7.82)	.253 (6.43)	.420 (10.67)	.250 (6.35)	.130 (3.30)
MDM-25PCBR*	1.185 (30.10)	.965 (24.51)	.734 (18.64)	.308 (7.82)	.184 (4.70)	.420 (10.67)	.250 (6.35)	.130 (3.30)
MDM-25SCBR*	1.185 (30.10)	.965 (24.51)	.802 (20.37)	.308 (7.82)	.253 (6.43)	.420 (10.67)	.250 (6.35)	.130 (3.30)
MDM-31PCBR*	1.335 (33.91)	1.115 (28.32)	.884 (22.45)	.308 (7.82)	.185 (4.70)	.520 (13.21)	.250 (6.35)	.130 (3.30)
MDM-31SCBR*	1.335 (33.91)	1.115 (28.32)	.952 (24.18)	.308 (7.82)	.253 (6.43)	.520 (13.21)	.250 (6.35)	.130 (3.30)
MDM-37PCBR*	1.485 (37.72)	1.265 (32.13)	1.034 (26.26)	.308 (7.82)	.185 (4.70)	.520 (13.21)	.250 (6.35)	.130 (3.30)
MDM-37SCBR*	1.485 (37.72)	1.265 (32.13)	1.102 (27.99)	.308 (7.82)	.253 (6.43)	.520 (13.21)	.250 (6.35)	.130 (3.30)
MDM-51PCBR*	1.435 (36.45)	1.215 (30.86)	.984 (24.99)	.351 (8.92)	.228 (5.79)	.650 (16.15)	.300 (7.62)	.150 (3.81)
MDM-51SCBR*	1.435 (36.45)	1.215 (30.86)	1.052 (26.72)	.351 (8.92)	.296 (7.52)	.650 (16.15)	.300 (7.62)	.150 (3.81)
MDM-100PCBR*	2.170 (55.12)	1.800 (45.72)	1.384 (35.15)	.394 (10.01)	.271 (6.88)	1.000 (25.40)	.400 (10.16)	.200 (5.08)
MDM-100SCBR*	2.170 (55.12)	1.800 (45.72)	1.508 (38.10)	.394 (10.01)	.394 (10.01)	1.000 (25.40)	.400 (10.16)	.200 (5.08)

*For jackpost, add letter "P" or "M7" for sizes 9-51, "M17" for size 100.

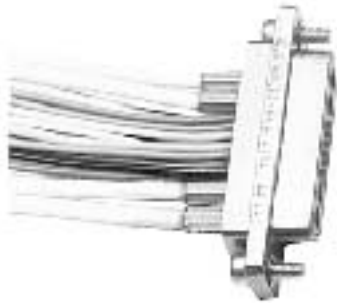

MDM Coaxial

The MDM Metal Shell Connectors have been tooled in several coaxial layouts and offer the versatility of combining coaxial and signal lines in the same connector. Any modifications to these layouts or new requirements, please consult the factory. For ordering information see page 232. For contact layouts see page 233. Standard coax is RG178 white.

MDM Power

The same insulator that is used with coaxial contacts is available with power contacts. This offers the versatility of combining power and signal lines in the same connector.

MDM Coaxial/Power

Power and coaxial contacts can be interchanged as desired. Power contacts are rated at 13 amps, 24V rms, AWG #16 stranded.

7C2/7P2

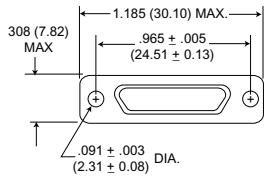

Plug

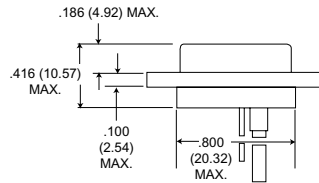

Receptacle

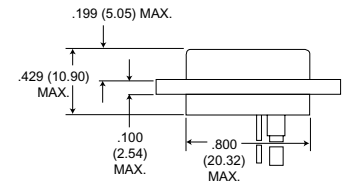
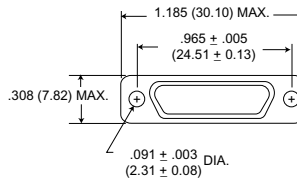

24C4/24P4

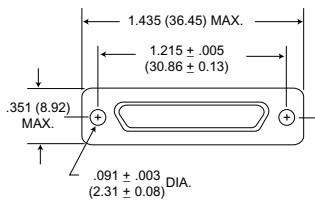

Plug

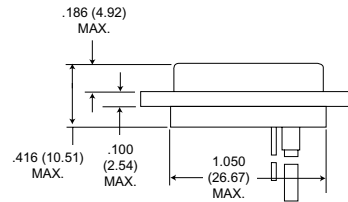

Receptacle

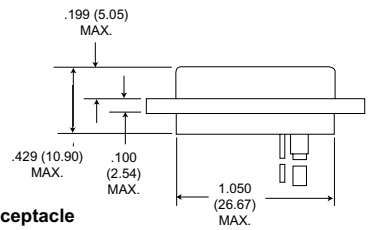
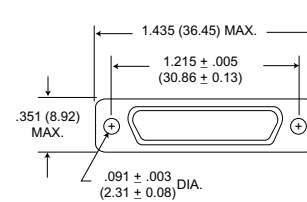

Coaxial Contacts

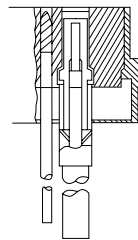

Plug

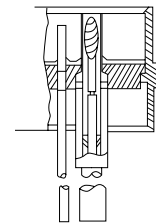

Receptacle

Power Contacts

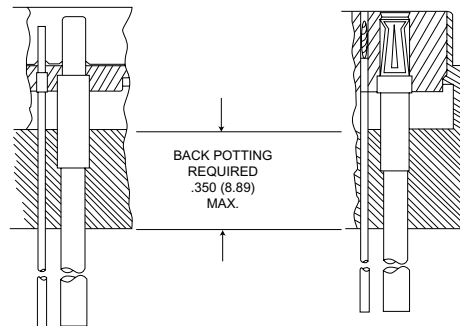

Receptacle

Plug

Microminiature Rectangular Connectors with MICRO-Pin Contacts on .050 (1.27) centers.

MICRO-D microminiature rack/panel connectors are used in applications requiring highly reliable, extremely small, lightweight connectors.

These connectors are available in 2 insulator materials, 2 mounting variations, 7 shell sizes accommodating from 9 to 51 contacts and a special arrangement of 5 micro contacts and 2 coaxials. The insulator materials listed give the MICRO-D connector wide versatility in most applications required by industry.

ITT Cannon can also terminate a wide variety of stranded or solid wire directly to MICRO-D contacts, which is often desirable in high density arrangements. MICRO-D connectors can also be custom harnessed to meet any customer requirement of single or multiple connectors. Pigtail lead and harness description must be given by the customer. A typical description would be: .5" #25 AWG, gold plated copper leads or 18" of #26 yellow, Teflon-insulated, Type E wire. Shown below are various methods of termination. Consult the factory for any routine or complex harnessing of MICRO-D connectors.

- Glass-filled diallyl phthalate-a thermoset material used in high temperature applications that is immune to cleaning solvents. It also has excellent dielectric properties. Temperature range: -65°F to +300°F (-55°C to +149°C).
- Glass-filled polyester-a thermoplastic that is not affected by cleaning solvents and exhibits excellent dielectric properties. Temperature range: -55°F to +257°F (-65°C to +125°C).

How to Order

PCB ordering information - page 242

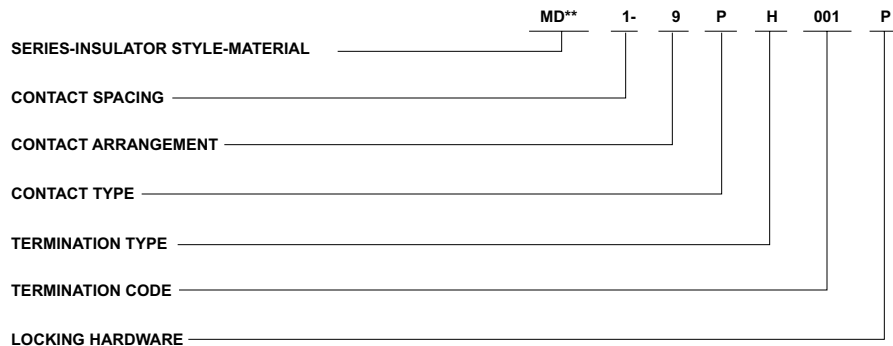

SERIES-INSULATOR STYLE-MATERIAL

- MD - Clip mounting -Diallyl phthalate
- MDB - Screw mounting-Diallyl phthalate
- MDV - Clip mounting-Polyester
- MDVB - Screw mounting-Polyester

CONTACT SPACING

- 1 - .050 (1.27) centers

CONTACT ARRANGEMENT

- 9-15-21-25-31*-37-51. See page 233.

CONTACT TYPE

- P - Pin
- S - Socket

TERMINATION TYPE

- H - Insulated solid or stranded wire
- L - Uninsulated solid wire
- S - Solder pot to accept #26 AWG max. harness wire.

TERMINATION CODE**

- (H) 001 - 18", 7/34 strand, #26 AWG, MIL-W-16878/4, Type E Teflon, Yellow.
- (H) 003 - 18", 7/34 strand, #26 AWG, MIL-W-16878/4, Type E Teflon, color coded to MIL-STD-681 System I.
- (L) 1 - 1/2" uninsulated solid #25 AWG gold plated copper.
- (L) 2 - 1" uninsulated solid #25 AWG gold plated copper.

LOCKING HARDWARE (SCREW MOUNTING ONLY)

- P - Jackpost
- K - Jackscrew-standard
- L - Jackscrew-low profile
- F - Float mount
- M - Military specification hardware, see page 237.
- No designator - No hardware - standard mounting .091 (2.31) hole diameter

* Not available in clip mounting.
** See table below for additional codes.

Standard Wire Termination Codes

For lengths not shown, consult factory for proper modification code. All wire lengths are minimum.

Harness Type (H)

#26 AWG per MIL-W-16878 Type E Teflon, stranded.

Length	All Yellow	Color Coded*
3 (76.2)	H020	H027
6 (152.4)	H019	H016
8 (203.2)	H026	H034
10 (254.0)	H029	H025
12 (304.8)	H028	H002
18 (457.2)	H001	H003
20 (508.0)	H038	H023
24 (609.6)	H009	H004
30 (762.0)	H010	H005
36 (914.4)	H011	H006
48 (1219.2)	H013	H048
72 (1828.8)	H017	H046
120 (3048.0)	H042	H041

* Cavity #1 black

Solid Uninsulated Type (L)

#25 AWG Gold Plated Copper

Termination Code	Length
L61	.125 (3.18)
L56	.150 (3.81)
L57	.190 (4.83)
L39	.250 (6.35)
L58	.375 (9.52)
L1	.500 (12.70)
L14	.750 (19.05)
L2	1.000 (25.40)
L7	1.500 (38.10)
L6	2.000 (50.80)
L16	2.500 (63.50)
L10	3.000 (76.20)

Performance and Material Specifications

MATERIALS AND FINISHES

Shell/Insulator (One Piece)	MD/MDB: Glass-filled thermoset plastic MDV/MDVB: Thermoplastic
Contacts	- Copper alloy, gold plate

ELECTRICAL DATA

No of Contacts	- 9 to 51: (1 arrangement of 5 contacts and 2 coaxials - for screw mount only)
Coaxial Cable	- RG-178/U (Not available for MD clip mount)
Wire Size	- #24 thru #32 AWG
Contact Termination	- Crimp stationary

MECHANICAL FEATURES

Size or Length	- 7 sizes
Coupling	- Friction/jackscrews
Polarization	- Keystone-shaped shells
Contact Spacing Centers	- .050 (1.27mm)
Shell Styles	- Plug and receptacle

Consult factory for availability.

With Clip Mounting Slots

Plug



MD Glass-filled Diallyl Phthalate Plastic Insulator

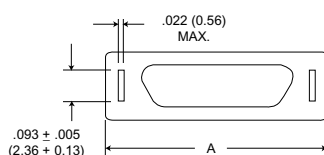

MDV Glass-filled Polyester Plastic Insulator

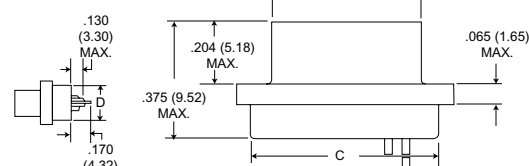

Solder Pot

Receptacle

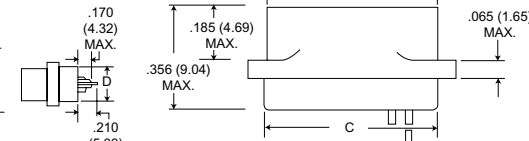
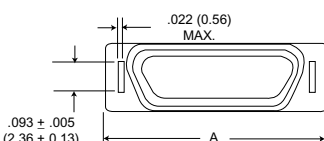

Solder Pot

Part Number by Shell Size		A Max.	B Max.	C Max.	D Max.	E Max.	Avg. Weight*** ±5% (oz.)/±5% (gm.)
MD1-9P**	MDV1-9-P**	.512 (13.00)	.292 (7.42)	.405 (10.29)	.170 (4.32)	.215 (5.46)	.026 (0.73)
MD1-9S**	MDV1-9S**	.512 (13.00)	.376 (9.55)	.405 (10.29)	.170 (4.32)	.215 (5.46)	.026 (0.73)
MD1-15P**	MDV1-15P**	.662 (16.81)	.442 (11.23)	.555 (14.10)	.170 (4.32)	.215 (5.46)	.038 (1.10)
MD1-15S**	MDV1-15S**	.662 (16.81)	.526 (13.36)	.555 (14.10)	.170 (4.32)	.215 (5.46)	.035 (1.00)
MD1-21P**	MDV1-21P**	.812 (20.62)	.592 (15.04)	.705 (17.91)	.170 (4.32)	.215 (5.46)	.053 (1.50)
MD1-21S**	MDV1-21S**	.812 (20.62)	.676 (17.17)	.705 (17.91)	.170 (4.32)	.215 (5.46)	.050 (1.40)
MD1-25P**	MDV1-25P**	.912 (23.16)	.692 (17.58)	.805 (20.45)	.170 (4.32)	.215 (5.46)	.063 (1.80)
MD1-25S**	MDV1-25S**	.912 (23.16)	.776 (19.71)	.805 (20.45)	.170 (4.32)	.215 (5.46)	.056 (1.60)
MD1-37P**	MDV1-37P**	1.212 (30.78)	.992 (25.20)	1.105 (28.07)	.170 (4.32)	.215 (5.46)	.086 (2.45)
MD1-37S**	MDV1-37S**	1.212 (30.78)	1.076 (27.33)	1.105 (28.07)	.170 (4.32)	.215 (5.46)	.076 (2.15)
MD1-51P**	MDV1-51P**	1.162 (29.51)	.942 (23.93)	1.055 (26.80)	.213 (5.41)	.258 (6.55)	.109 (3.10)
MD1-51S**	MDV1-51S**	1.162 (29.51)	1.026 (26.06)	1.055 (26.80)	.213 (5.41)	.258 (6.55)	.093 (2.65)

** Add lead type and length, see Part Number Explanation.

*** Weight given is with 1/2", uninsulated solid #25 AWG gold plated copper pigtailed.

Panel Mounting Hardware

Clip Mounting

Illustrated is the recommended method of front mounting with metal panel mounting keys. Panel mounting keys are available with or without coupling retention clips.

For front mounting, place the rear of the connector thru the panel cutout. With the mounting flange against the panel, fully insert the panel mounting keys thru the slots in the flange and thru the panel cutout. Retaining the keys in this position, bend them outward against the rear of the panel. When mating a front mounted connector with an unmounted connector, a coupling retention clip assembly may be used to securely lock the two together. Mounting screw brackets are available and may be used instead of the panel mounting keys.



Coupling Retention Clip
(see Figure 2)



Mounting Screw Brackets
(see Figures 1 and 3)



Edgeboard Mounted
(see Figure 4)



Panel Mounting Key

Description	Part Number
Panel Mounting Key	201-9100-000
Mounting Key and Coupling Clip Assembly	294-9100-000
Mounting Screw Bracket	015-9100-000
* Edgeboard Mounting Bracket	015-5009-000

** Edgeboard Mounting Bracket and

Coupling Clip Assembly **MD51428-1**

* Must be ordered separately; specify left and right hand for complete assembly.

** Must be ordered separately; assembly contains set of left and right hand types.

Dimensions (Clip Mounting Only)

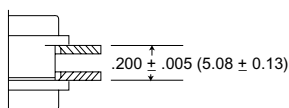

Plug and Receptacle
Rear Mounted

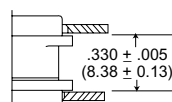

Plug and Receptacle
Front Mounted

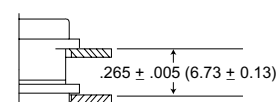

Plug Front Mounted
Receptacle Rear Mounted

Panel Cutouts

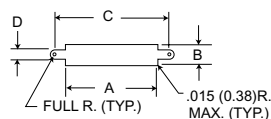

Figure 1

Front Mounting

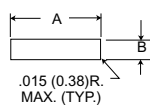

Figure 2

Edgeboard Mounting

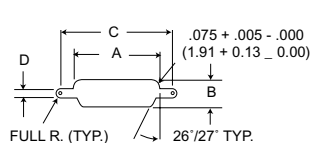

Figure 3

Rear Mounting

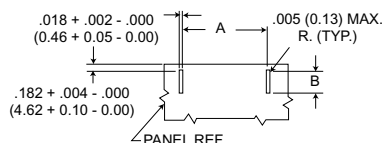

Figure 4

Edgeboard Mounting

1. A panel thickness of 1/8" (3.17mm) maximum is recommended for ease of tab bending when a panel mounting key & clip assembly or edgeboard mounting brackets are used.
2. Front mounting is preferred. However, when rear mounting is necessary, use figure 3 for dimensions.
3. Figure 4 is for edge board mounting bracket or edgeboard clip assembly. The .184 ± .002 (2.67 ± 0.05) dimension locates the MD socket insulator flus with the end of the board.
4. Screw brackets (015-9100-000) will accommodate #2-56 screws.
5. Front mounting (Fig. 1) and rear mounting (Fig. 3) accommodate #2-56 screws when jackscrews are used. See details on page 24 when jackposts are used.

Shell Size	Cutout Figure	A	B	C	D
		+ .004 (0.10) - .000 (0.00)	+ .004 (0.10) - .000 (0.00)	+ .004 (0.10) - .000 (0.00)	+ .005 (0.13) - .000 (0.00)
9	1	.408 (10.36)	.172 (4.37)	.650 (16.51)	.089 (2.26)
	2	.408 (10.36)	.172 (4.37)	-	-
	3	.378 (9.60)	.217 (5.51)	.650 (16.51)	.089 (2.26)
	4	.400 (10.16)	.091 (2.31)	-	-
15	1	.588 (14.94)	.172 (4.37)	.795 (20.19)	.089 (2.26)
	2	.588 (14.94)	.172 (4.37)	-	-
	3	.528 (13.28)	.217 (5.51)	.795 (20.19)	.089 (2.26)
	4	.550 (13.97)	.091 (2.31)	-	-
21	1	.738 (18.75)	.172 (4.37)	.945 (24.00)	.089 (2.26)
	2	.738 (18.75)	.172 (4.37)	-	-
	3	.678 (17.27)	.217 (5.51)	.945 (24.00)	.089 (2.26)
	4	.700 (17.78)	.091 (2.31)	-	-
25	1	.838 (21.29)	.172 (4.37)	1.045 (26.54)	.089 (2.26)
	2	.838 (21.29)	.172 (4.37)	-	-
	3	.778 (19.76)	.217 (5.51)	1.045 (26.54)	.089 (2.26)
	4	.800 (20.32)	.091 (2.31)	-	-
37	1	1.138 (28.91)	.172 (4.37)	1.345 (34.16)	.089 (2.26)
	2	1.138 (28.91)	.172 (4.37)	-	-
	3	1.078 (27.38)	.217 (5.51)	1.345 (34.16)	.089 (2.26)
	4	1.100 (27.94)	.091 (2.31)	-	-
51	1	1.088 (27.64)	.215 (5.46)	1.295 (32.89)	.089 (2.26)
	2	1.088 (27.64)	.215 (5.46)	-	-
	3	1.028 (26.11)	.260 (6.60)	1.295 (32.89)	.089 (2.26)
	4	1.050 (26.67)	.091 (2.31)	-	-

With Screw Mounting Holes (Conforms to MIL-C-83513)

Plug



Receptacle



MDB Glass-filled Diallyl Phthalate Plastic Insulator MDVB Glass-filled Polyester Plastic Insulator

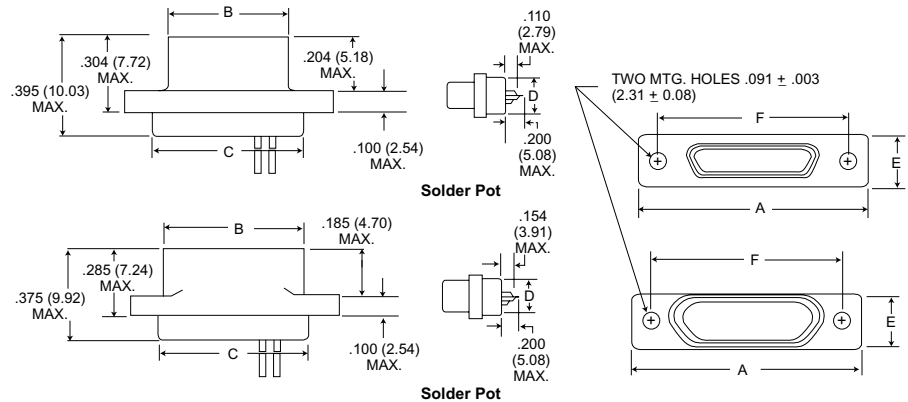

Part Number by Shell Size		A Max.	B Max.	C Max.	D Max.	E Max.	F ±.005	Avg. Weight*** ±5% (oz.) ±5% (gm.)
MDB1-9P**	MDVB1-9P**	.788 (20.02)	.292 (7.42)	.408 (10.36)	.173 (4.39)	.218 (5.54)	.565 (14.35)	.026 (0.73)
MDB1-9S**	MDVB1-9S**	.788 (20.02)	.380 (9.65)	.408 (10.36)	.173 (4.39)	.218 (5.54)	.565 (14.35)	.025 (0.70)
MDB1-15P**	MDVB1-15P**	.938 (23.82)	.442 (11.23)	.588 (14.17)	.173 (4.39)	.218 (5.54)	.715 (18.16)	.038 (1.10)
MDB1-15S**	MDVB1-15S**	.938 (23.82)	.530 (13.46)	.588 (14.17)	.173 (4.39)	.218 (5.54)	.715 (18.16)	.035 (1.00)
MDB1-21P**	MDVB1-21P**	1.088 (27.64)	.592 (15.04)	.708 (17.98)	.173 (4.39)	.218 (5.54)	.865 (21.97)	.053 (1.50)
MDB1-21S**	MDVB1-21S**	1.088 (27.64)	.680 (17.27)	.708 (17.98)	.173 (4.39)	.218 (5.54)	.865 (21.97)	.050 (1.40)
MDB1-25P**	MDVB1-25P**	1.188 (30.18)	.692 (17.58)	.808 (20.56)	.173 (4.39)	.218 (5.54)	.965 (24.51)	.063 (1.80)
MDB1-25S**	MDVB1-25S**	1.188 (30.18)	.780 (19.81)	.808 (20.56)	.173 (4.39)	.218 (5.54)	.965 (24.51)	.056 (1.60)
MDB1-31P**	MDVB1-31P**	1.338 (33.98)	.842 (21.39)	.958 (24.33)	.173 (4.39)	.218 (5.54)	1.115 (28.32)	.080 (2.30)
MDB1-31S**	MDVB1-31S**	1.338 (33.98)	.930 (23.62)	.958 (24.33)	.173 (4.39)	.218 (5.54)	1.115 (28.32)	.073 (2.10)
MDB1-37P**	MDVB1-37P**	1.488 (37.80)	.992 (25.20)	1.108 (28.14)	.173 (4.39)	.218 (5.54)	1.265 (32.13)	.086 (2.45)
MDB1-37S**	MDVB1-37S**	1.488 (37.80)	1.080 (27.43)	1.108 (28.14)	.173 (4.39)	.218 (5.54)	1.265 (32.13)	.076 (2.15)
MDB1-51P**	MDVB1-51P**	1.438 (36.52)	.942 (23.93)	1.058 (26.87)	.220 (5.59)	.260 (6.60)	1.215 (30.86)	.109 (3.10)
MDB1-51S**	MDVB1-51S**	1.438 (36.52)	1.030 (26.16)	1.058 (26.87)	.220 (5.59)	.260 (6.60)	1.215 (30.86)	.093 (2.64)

** Add lead type and length, see Part Number Explanation.
 *** Weight given is with 1/2", uninsulated solid #25 AWG gold plated copper pigtailed.

MD*B-PCB connectors use standard MD*B all plastic shells and are designed for use with flex circuitry, printed circuit and multi-layer boards. They are easily mounted and soldered and provide high density/high reliability in board-to-board and board-to-cable applications. While being similar to the MDM-PCB connectors, the MD*B-PCB connectors are all plastic, extremely small, and lightweight yet rugged enough for use in the most demanding applications.

MD*B-PCB connectors are available in seven shell sizes with 9 to 51 contacts in the popular 90° narrow profile PCB termination, with a variety of tail lengths for varying board thickness.

Jackpost mounting for use with locking hardware is also available.

If the connectors shown in the catalog do not meet the requirements of your applications, a special shape, size or layout using the basic all plastic shell can be made available. For further technical and applications information, contact your nearest ITT Cannon Technical sales office.



How to Order

	MD*B - 37 S CBR * L39 - ***
SERIES _____	
CONTACT ARRANGEMENT _____	
CONTACT TYPE _____	
TERMINATION TYPE _____	
HARDWARE _____	
TERMINATION TAIL LENGTH _____	
MODIFICATION CODES _____	
(Consult Factory)	
CONNECTOR SERIES	
MDVB, MDB	
CONNECTOR SERIES	
9, 15, 21, 25, 31, 37, 51	
CONTACT TYPE	
S = Socket	
P = Pin	
TERMINATION TYPE	
CBR = 90° Narrow Profile PCB Terminations	
HARDWARE	
P = Jackpost	
M7 = Jackposts, M83513/5-07	
No Letter = Less Hardware	
TERMINATION TAIL LENGTH CODES	
None - .109 (2.77) ± 0.15 (0.38) Standard	
L61 - .125 (3.18)	
L56 - .150 (3.81)	
L57 - .190 (4.83)	
L39 - .250 (6.35)	
L5 - .375 (9.52)	

CBR Series (90° Mounting Narrow Profile)

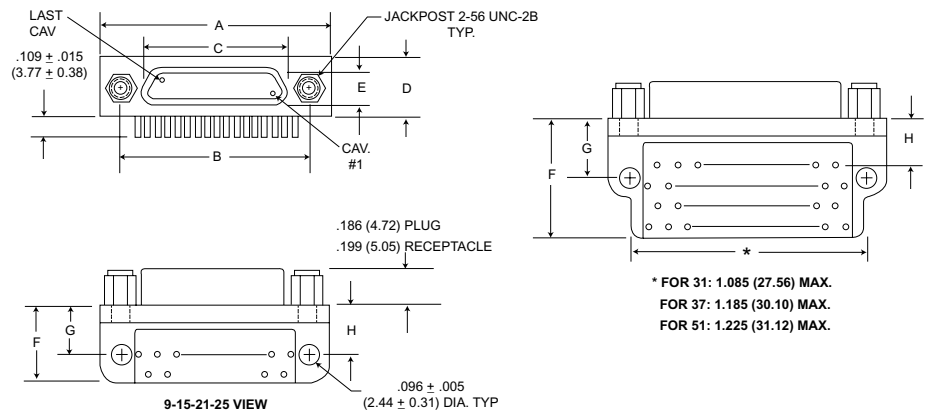

PCB Termination Arrangements (Viewed from bottom of connector, on PCB solder side.)

Identification number shown for plug connector, use reverse order for socket connector.

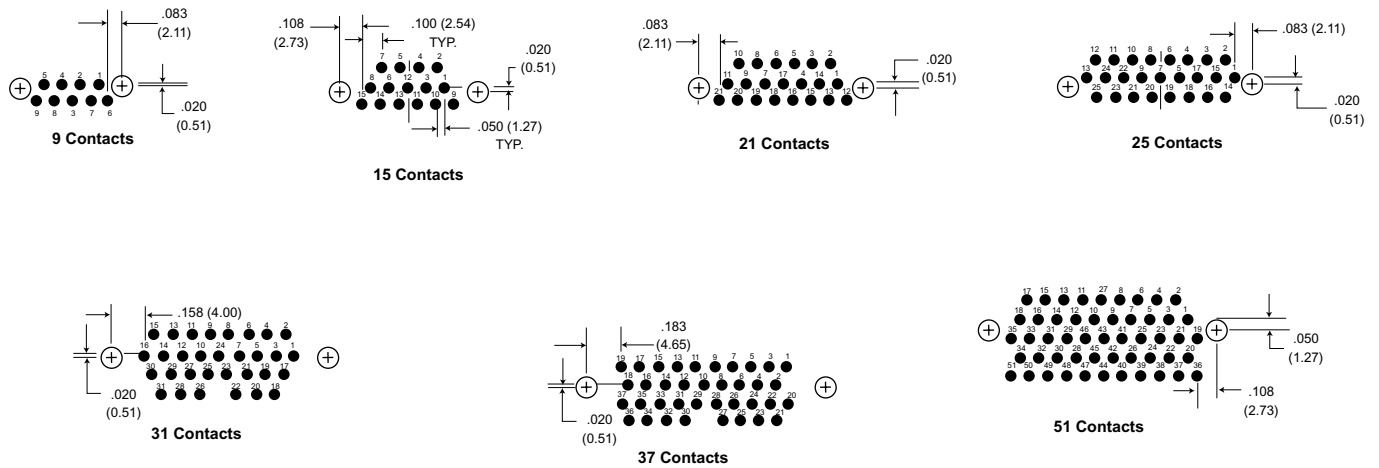

All Termination Configurations .100 (2.54) x .100 (2.54) Grid Pattern, Offset .050 (1.27)

Part Number By Shell Size	A Max.	B ± .005 (0.13)	C Max.	D Max.	E Max.	F Max.	G ± .010 (0.25)	H ± .010 (0.25)
MD*B-9PCBR*	.788 (20.01)	.565 (14.35)	.292 (7.42)	.218 (5.54)	.134 (3.40)	.420 (10.67)	.250 (6.35)	.230 (5.84)
MD*B-9SCBR*	.788 (20.01)	.565 (14.35)	.375 (9.52)	.218 (5.54)	.218 (5.54)	.420 (10.67)	.250 (6.35)	.230 (5.84)
MD*B-15PCBR*	.938 (23.82)	.715 (18.16)	.442 (11.23)	.218 (5.54)	.134 (3.40)	.420 (10.67)	.250 (6.35)	.130 (3.30)
MD*B-15SCBR*	.938 (23.82)	.715 (18.16)	.525 (13.34)	.218 (5.54)	.218 (5.54)	.420 (10.67)	.250 (6.35)	.130 (3.30)
MD*B-21PCBR*	1.088 (27.63)	.865 (21.97)	.592 (15.04)	.218 (5.54)	.134 (3.40)	.420 (10.67)	.250 (6.35)	.130 (3.30)
MD*B-21SCBR*	1.088 (27.63)	.865 (21.97)	.675 (17.14)	.218 (5.54)	.218 (5.54)	.420 (10.67)	.250 (6.35)	.130 (3.30)
MD*B-25PCBR*	1.188 (30.17)	.965 (24.51)	.692 (17.58)	.218 (5.54)	.134 (3.40)	.420 (10.67)	.250 (6.35)	.130 (3.30)
MD*B-25SCBR*	1.188 (30.17)	.965 (24.51)	.775 (19.68)	.218 (5.54)	.218 (5.54)	.420 (10.67)	.250 (6.35)	.130 (3.30)
MD*B-31PCBR*	1.338 (33.98)	1.115 (28.32)	.842 (21.39)	.218 (5.54)	.134 (3.40)	.420 (10.67)	.250 (6.35)	.130 (3.30)
MD*B-31SCBR*	1.338 (33.98)	1.115 (28.32)	.925 (23.50)	.218 (5.54)	.218 (5.54)	.420 (10.67)	.250 (6.35)	.130 (3.30)
MD*B-37PCBR*	1.488 (37.79)	1.265 (32.13)	.994 (25.25)	.218 (5.54)	.134 (3.40)	.520 (13.21)	.250 (6.35)	.130 (3.30)
MD*B-37SCBR	1.488 (37.79)	1.265 (32.13)	1.075 (27.30)	.218 (5.54)	.218 (5.54)	.520 (13.21)	.250 (6.35)	.130 (3.30)
MD*B-51PCBR*	1.438 (36.52)	1.215 (30.86)	.942 (23.93)	.258 (6.55)	.177 (4.50)	.550 (13.97)	.300 (7.62)	.150 (3.81)
MD*B-51SCBR	1.438 (36.52)	1.215 (30.86)	1.026 (26.06)	.258 (6.55)	.258 (6.55)	.550 (13.97)	.300 (7.62)	.150 (3.81)

* For jackpost locking add letter "P" or "M7".

NOTE: Standard lead termination is #24 AWG, solid copper, solder or tin dipped.

MDB Coaxial Series with Screw Mounting Holes

MDB connectors with two coaxial and five MICRO-PIN™/MICROSOCKET™ contacts. Crimp-type coaxial contacts accommodate RG-178/U cables. A plastic insertion/extraction tool is supplied with each connector assembly having removable coaxial assembly.



How to Order - MDB Coaxial

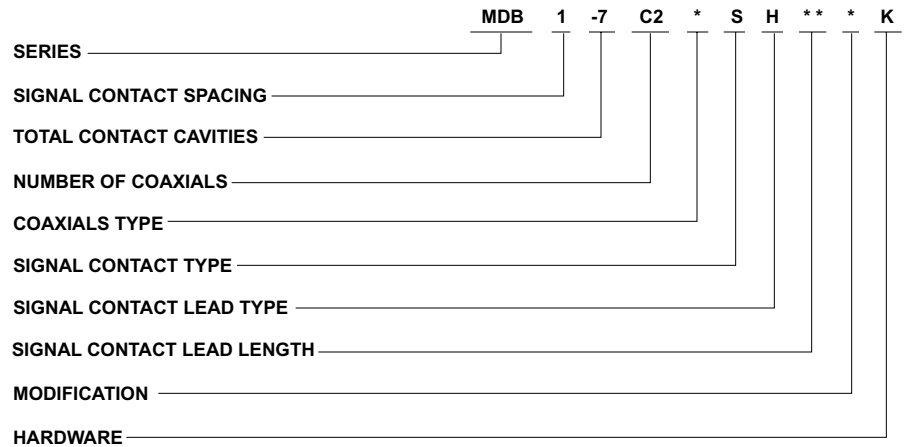

SERIES

Micro-D Coaxial

SIGNAL CONTACT SPACING

1 - .050 (1.27) centers

TOTAL CONTACT CAVITIES 7

NUMBER OF COAXIALS 2

COAXIALS TYPE

- No Letter - Coaxial assembly installed and nonremovable
- RO - coaxial assembly ordered separately
- RA - Coaxial shipped assembled but uninstalled

SIGNAL CONTACT TYPE

- P - Pin
- S - Socket

SIGNAL CONTACT LEAD TYPE

- L - Uninsulated, solid wire
- H - Insulated, solid or stranded
- S - Solder pot*

SIGNAL CONTACT LEAD LENGTH

See Standard Wire Termination
Code on page 247. Coaxial cable will be RG-178U unless otherwise specified; length will be same as wire modification.

MODIFICATION

Consult factory

HARDWARE

- No letter - No hardware standard mounting. .091 (2.31) hole diameter
- F - Float
- K - Jackscrew (standard)
- L - Jackscrew (low profile)
- P - Jackpost

* Not available with removalbe coax cable type connectors RO and RA.

How to Order - Coaxial Cable Assemblies

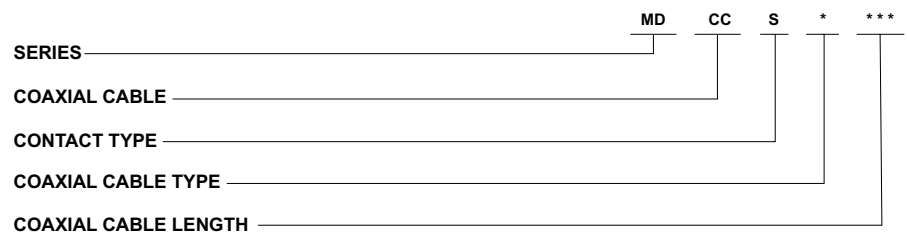

SERIES

ITT Cannon Prefix

COAXIAL CABLE

CC

CONTACT TYPE

- P - Pin (used with socket side connection)
- S - Socket (used with pin type connection)

COAXIAL CABLE TYPE

1 - RG178/U

COAXIAL CABLE LENGTH

See Standard Wire Termination
Codes on page 247. Coaxial cable will be RG-178U unless otherwise specified; length will be the same as wire modification.

Dimension - MDB Coaxial Series

(See page 233 for layouts)

Plug

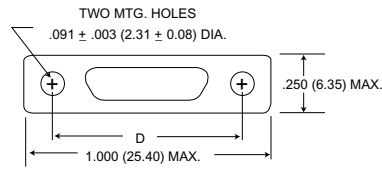
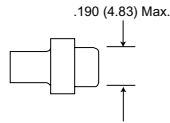

Receptacle

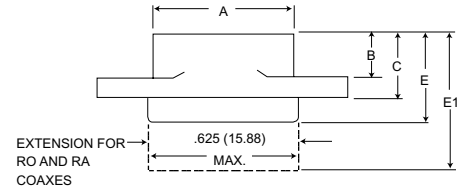
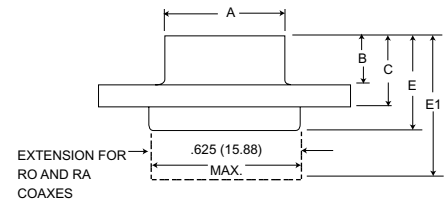
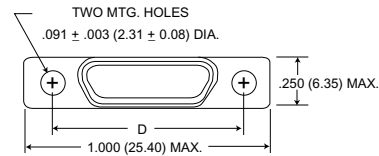
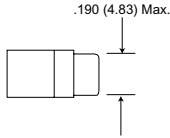

Part Number by Shell Size	A Max.	B Max.	C Max.	D ± .005 (0.13)	E Max.	E1 Max.	Avg. Weight** (oz) ± 5% (gm.) ± 5%
MDB1-7C2P*	.510 (12.95)	.204 (5.18)	.298 (7.57)	.782 (19.86)	.395 (10.03)	.510 (12.95)	.290 (8.30)
MDB1-7C2S*	.602 (15.29)	.185 (4.70)	.279 (7.09)	.782 (19.86)	.375 (9.52)	.540 (13.72)	.273 (7.80)

* Add lead type and length, see Part Number Explanation.

** Weight given is with 7 inch (177.80) insulated leads, #26 AWG silver plated copper pigtailed and RG178/U coaxials.

Mounting Hardware Views (Sizes 9-51)

This hardware supplied unassembled.

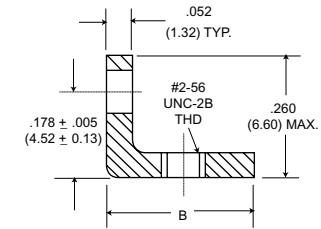
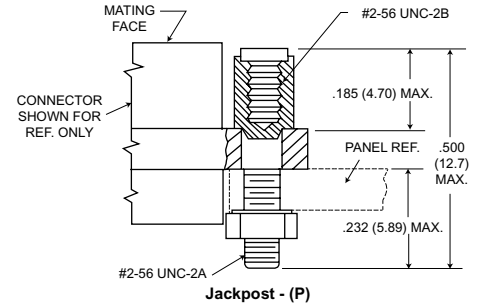
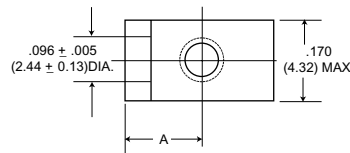
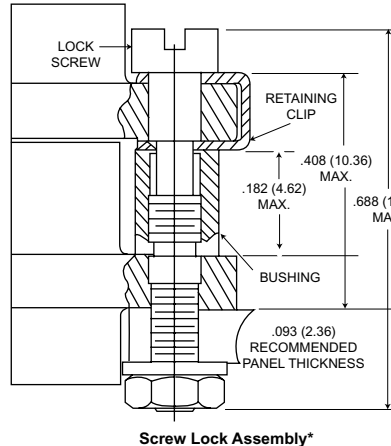

*NOTE: Torque value is 4.0 in/lbs max.

Description	Part Number	A ± .005 (0.13)	B Max.
Screw Lock Assembly	322-9500-000		
Jackpost Kit	320-9505-000		
Mounting Bracket, 90° Angle- MD*1 for 9 thru 37 Shell Sizes	015-9516-000	.100 (2.54)	.215 (5.46)
MD*1 for 51 Shell Size	015-9516-000	.122 (3.10)	.257 (6.53)

NOTES: Screw lock assembly (322-9500-000) can be used for front front mounting. Jackpost kit (320-9505-000) consists of 2 assemblies, shipped unassembled.

This hardware is factory installed.

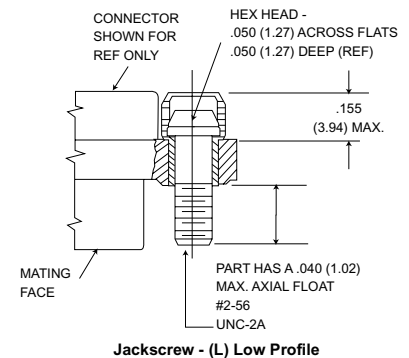
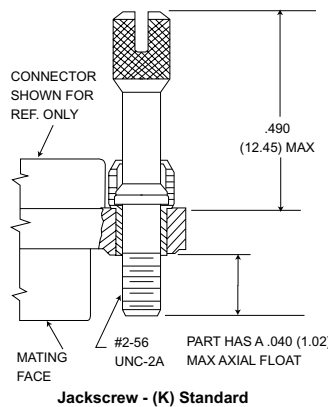
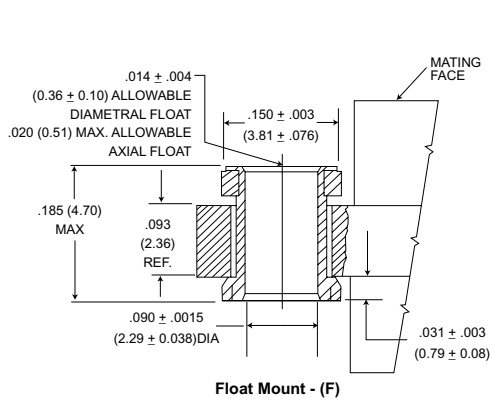

Shown here is a cutaway view of the float mount for the MD connector. The basic shell dimensions are the same for the float mount and the screw mounting hole configurations. View shown is for standard float mount front panel mounting. Reverse mounting is available on request.

* NOTE: Torque vales are as follows:
Low Profile Jackscrew (L)-2.5 in/lbs
Standard Jackscrew (K)-2.5 in/lbs

Mounting Hardware to Military Specification (Sizes 9 - 51) PER MIL-C-83513/5

This hardware supplied unassembled.

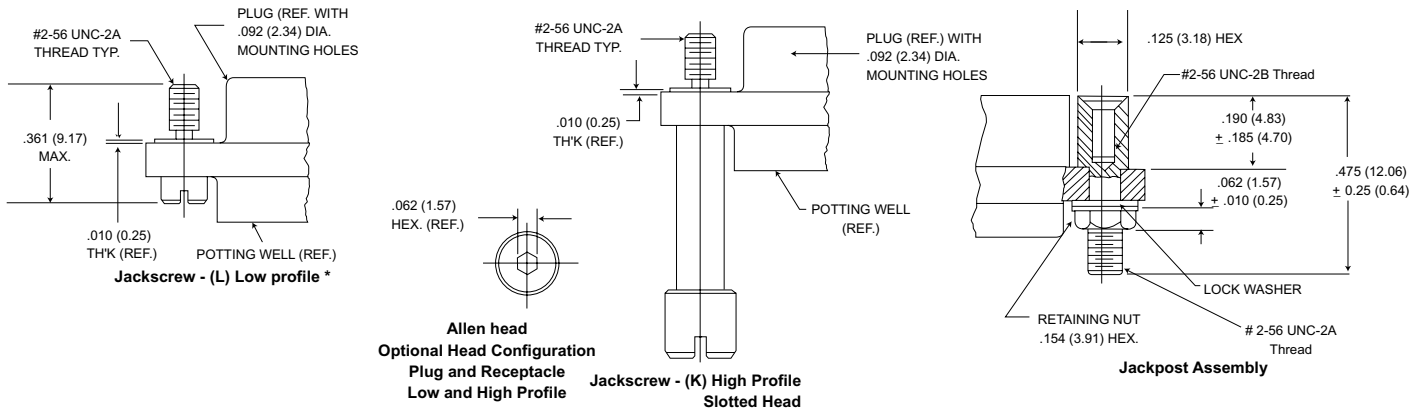

Description	M83513/5	Mode Code	Part Number
Slotted Head Jackscrew Assy Low Profile	-05	M5	320-9508-025
Slotted Head Jackscrew Assy High Profile	-06	M6	320-9508-027
Allen Head Jackscrew Assy Low Profile	-02	M2	320-9508-026
Allen Head Jackscrew Assy High Profile	-03	M3	320-9508-028
Jackpost Assy	-07	M7	320-9505-033

Jackpost Bushing (For Rear Panel Mounting)

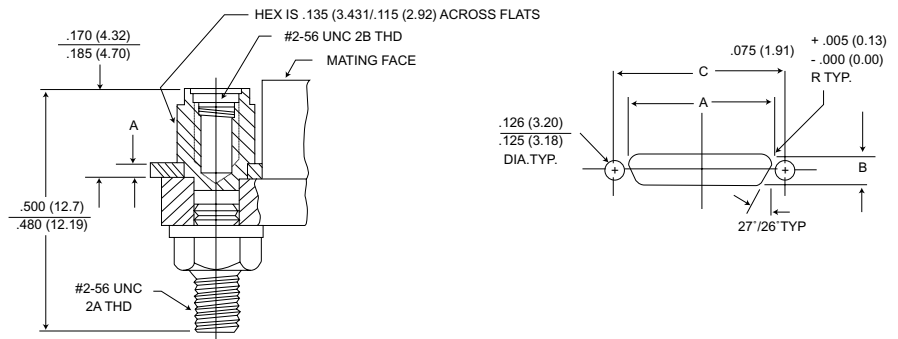

Panel Thickness	A Dim.	Jackpost Kit Number*
3/32 (2.4)	.092/.087 (2.34/2.21)	320-9505-007
1/16 (1.6)	.061/.056 (2.34/1.42)	320-9505-006
3/64 (1.2)	.047/.042 (1.19/1.07)	320-9505-005
1/32 (0.8)	.030/.025 (0.76/0.64)	320-9505-004

*2 Jackposts, 2 nuts, 2 washers.

Shell Size	Plug and Receptacle Dimensions		
	A	B	C
	+ .004 (0.10)	+ .004 (0.10)	± .005 (0.13)
	- .000 (0.00)	- .000 (0.00)	
9	.379 (9.63)	.219 (5.56)	.565 (14.35)
15	.529 (13.44)	.219 (5.56)	.715 (18.16)
21	.679 (17.25)	.219 (5.56)	.865 (21.97)
25	.779 (19.79)	.219 (5.56)	.965 (24.51)
31	.929 (23.60)	.219 (5.56)	1.115 (28.32)
37	1.079 (27.41)	.219 (5.56)	1.265 (32.13)
51	1.029 (26.14)	.261 (6.63)	1.215 (30.86)

Panel Mounting Dimensions

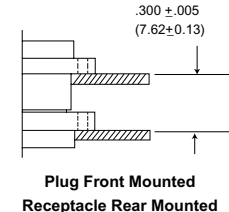
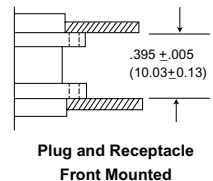
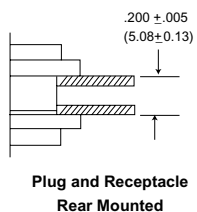

Panel Cutouts

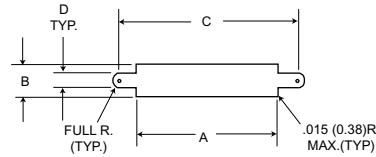

Figure 1
Front Mounting

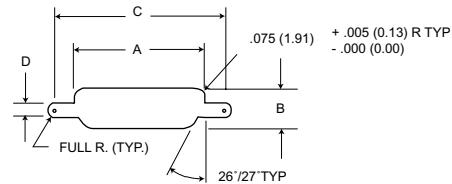

Figure 2
Rear Mounting

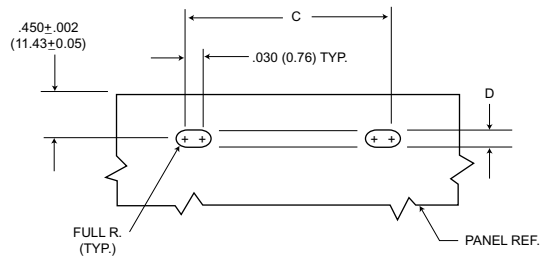

Figure 3
Edgeboard Mounting

Size	Cutout Figure	A		B		C		D	
		+ .004 (0.10) - .000 (0.00)		+ .004 (0.10) - .000 (0.00)		+ .005 (0.13) - .000 (0.00)		+ .005 (0.13) - .000 (0.00)	
9	1	.409 (10.39)		.172 (4.37)		.570 (14.48)		.089 (2.26)	
	2	.379 (9.63)		.219 (5.56)		.570 (14.48)		.089 (2.26)	
	3	-		-		.570 (14.48)		.089 (2.26)	
15	1	.559 (14.20)		.172 (4.37)		.720 (18.29)		.089 (2.26)	
	2	.529 (13.44)		.219 (5.56)		.720 (18.29)		.089 (2.26)	
	3	-		-		.720 (18.29)		.089 (2.26)	
21	1	.709 (18.00)		.172 (4.37)		.870 (22.10)		.089 (2.26)	
	2	.679 (17.25)		.219 (5.56)		.870 (22.10)		.089 (2.26)	
	3	-		-		.870 (22.10)		.089 (2.26)	
25	1	.809 (20.55)		.172 (4.37)		.970 (24.64)		.089 (2.26)	
	2	.779 (19.79)		.219 (5.56)		.970 (24.64)		.089 (2.26)	
	3	-		-		.970 (24.64)		.089 (2.26)	
31	1	.959 (24.36)		.172 (4.37)		1.120 (28.45)		.089 (2.26)	
	2	.929 (23.60)		.219 (5.56)		1.120 (28.45)		.089 (2.26)	
	3	-		-		1.120 (28.45)		.089 (2.26)	
37	1	1.109 (28.17)		.172 (4.37)		1.270 (32.26)		.089 (2.26)	
	2	1.079 (27.41)		.219 (5.56)		1.270 (32.26)		.089 (2.26)	
	3	-		-		1.270 (32.26)		.089 (2.26)	
51	1	1.059 (26.90)		.215 (5.46)		1.220 (30.99)		.089 (2.26)	
	2	1.029 (26.14)		.261 (6.63)		1.220 (30.99)		.089 (2.26)	
	3	-		-		1.220 (30.99)		.089 (2.26)	

NOTES:

1. Front mounting (figure 1) and rear mounting (figure 2) accommodates #2-56 screws when jackscrew are used. See detail on page 24 when jackposts are used.
2. Front mounting is preferred. However, when rear mounting is necessary. use figure 2 dimensions.
3. Edgeboard mounting bracket (figure3) uses #2-56 screws. Dimension .450 ± .002 (11.43 ± 0.05) locates the MD receptacle flush with the end of the board.



The MJS jackscrew series provides a reliable interconnect for board-to-board, board-to-cable and in-line cable-to-cable applications. Layouts accommodating up to 76 MICROPIN/MICROSOCKET™

contacts are available, with the same wide range of options as are offered with the other MICRO Line products offered in this catalog.

How to Order

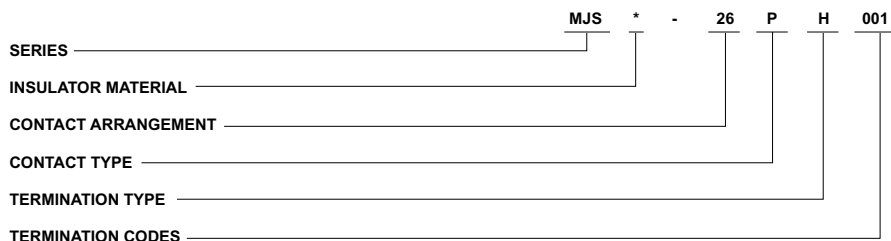

SERIES

MJS - Micro Center Jackscrew

INSULATOR MATERIAL

- B - Diallyl phthalate
- V - Polyester
- U - Polyetherimide
- R - Polyphenylene sulfide

CONTACT ARRANGEMENTS

- Unshrouded Receptacle: 10, 26, 51, 66
- Shrouded Receptacle: 10, 34, 42, 76
- Low Profile Plug and Receptacle (shrouded): 28

CONTACT TYPE

- P - Pin
- S - Socket

TERMINATION TYPE

- H - Insulated wire harness.
- I - Integral tail (MJSV-28S only).
- L - Solid - uninsulated wire.
- S - Solder pot to accept #26 AWG harness wire.
- T - Thru bundle pigtail (MJSV-28P only).

TERMINATION CODE*

- (H) 001 - 18" , 7/34 strand, #26 AWG, MIL-W-16878/4, Type E Teflon, yellow.
- (H) 003 - 18" , 7/34 strand, #26 AWG, MIL-W-16878/4, Type E Teflon, color coded to MIL-STD-681 System I.
- (L) 1 - 1/2" uninsulated solid #25 AWG gold plated copper.
- (L) 2 - 1" uninsulated solid #25 AWG gold plated copper.

* See Termination Codes shown below for additional length modification codes.

Standard Wire Termination Codes

The following termination codes are listed for you information. For lengths not shown, consult factory for proper modification code. **All wire lengths are minimum.**

Harness Type (H)

#26 AWG per MIL-W-16878/4 Type E Teflon, 7/34 stranded.

Length	All Yellow	Color Coded
3 (76.2)	H 020	H 027
6 (152.4)	H 019	H 016
8 (203.2)	H 026	H 034
10 (254.0)	H 029	H 025
12 (304.8)	H 028	H 002
18 (457.2)	H 001	H 003
20 (508.0)	H 038	H 023

Solid Uninsulated Type (L)

#25 AWG gold plated copper.

Termination Code	Length	Termination Code	Length
L61	.125 (3.18)	L14	.750 (19.05)
L56	.150 (3.81)	L2	1.000 (25.40)
L57	.190 (4.83)	L7	1.500 (38.10)
L39	.250 (6.35)	L6	2.000 (50.80)
L58	.375 (9.53)	L16	2.500 (63.50)
L1	.500 (12.70)	L10	3.000 (76.20)

Contact Arrangements

Face view of pin-use reverse order for socket

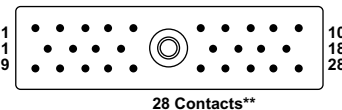
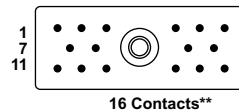

MJSB/MJSU

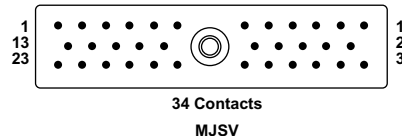

34 Contacts
MJSV

Identification numbers are for reference only and do not appear on connectors.

*Low profile configuration
**MJSV & MJSR

Unshrouded Receptacle (10-26-51-66)

MJSB/MJSU

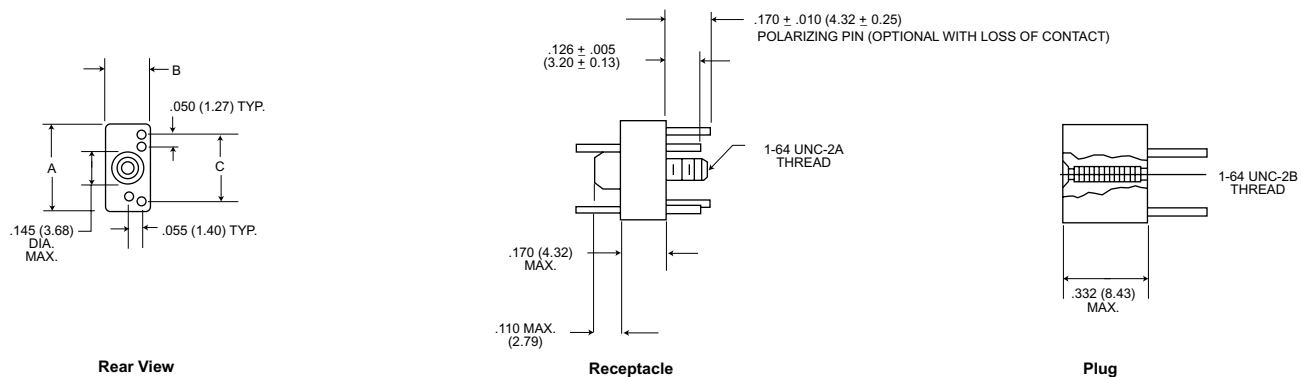

STANDARD MATERIALS AND FINISHES

Micropin	Copper alloy, 50 micro-inch gold
Microsocket	Copper alloy, 50 micro-inch gold
Insulator	Diallyl phthalate, green color or polyetherimide, natural color
Jackscrew	Stainless steel, passivated & lubricated
Retainer, Jackscrew	Stainless steel, passivated
Insert, Threaded	Stainless steel, passivated
Post, Polarizing	Stainless steel, passivated

Part Number	A Max.	B Max.	C Bsc.
MJSB or MJSU-10P	.378 (9.60)	.190 (4.83)	.290 (7.37)
MJSB or MJSU-10S	.378 (9.60)	.190 (4.83)	.290 (7.37)
MJSB or MJSU-26P	.778 (19.76)	.190 (4.83)	.690 (17.53)
MJSB or MJSU-26S	.778 (19.76)	.190 (4.83)	.690 (17.53)
MJSB or MJSU-51P	1.028 (26.11)	.260 (6.60)	.940 (23.88)
MJSB or MJSU-51S	1.028 (26.11)	.260 (6.60)	.940 (23.88)
MJSB or MJSU-66P	1.280 (32.51)	.260 (6.60)	1.190 (30.23)
MJSB or MJSU-66S	1.280 (32.51)	.260 (6.60)	1.190 (30.23)

Shrouded Receptacle (16-28*-34)

MJSV/MJSR

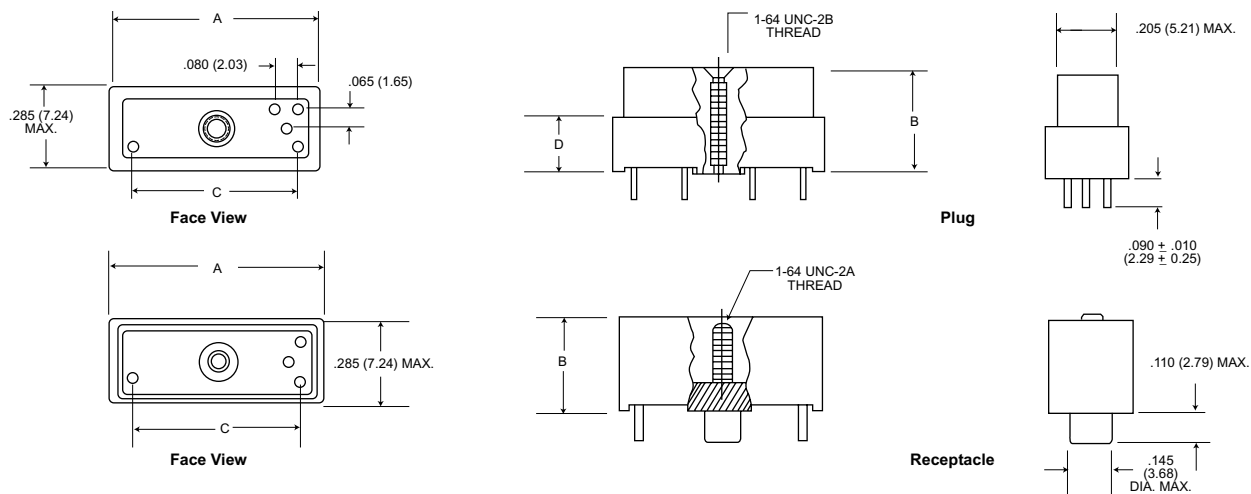

STANDARD MATERIALS AND FINISHES

Micropin	Copper alloy, 50 micro-inch gold
Microsocket	Copper alloy, 50 micro-inch gold
Insulator	Polyester, black color Polyphenylene sulfide, black color
Jackscrew	Stainless steel, passivated & lubricated
Retainer, Jackscrew	Stainless steel, passivated
Insert, Threaded	Stainless steel, passivated
Post, Polarizing	Stainless steel, passivated

Part Number	A Max.	B Max.	C Ref.	D ± .006 (0.15)
MJSV or MJSR-16P	.700 (17.78)	.345 (8.76)	.545 (13.84)	.175 (4.45)
MJSV or MJSR-16S	.700 (17.78)	.320 (8.13)	.545 (13.84)	-
MJSV-28P*	1.020 (25.91)	.232 (5.89)	.865 (21.97)	.062 (1.57)
MJSV-28S*	1.020 (25.91)	.246 (6.25)	.865 (21.97)	-
MJSV-34P	1.180 (29.97)	.330 (8.38)	1.025 (26.04)	.160 (4.06)
MJSV-34S	1.180 (29.97)	.305 (7.75)	1.025 (26.04)	-

*Low profile configuration, for "L" (uninsulated solid wire) termination add .090 (2.29) to the "B" dimension. For "H" (insulated wire) termination add .200 (5.08) to the "B" dimension.

Shrouded Receptacle (42)

MJSR-42P

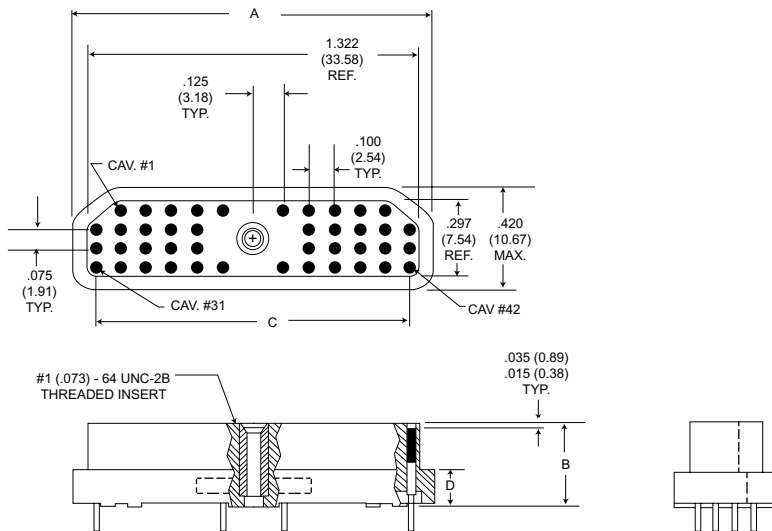

MJSR-42S

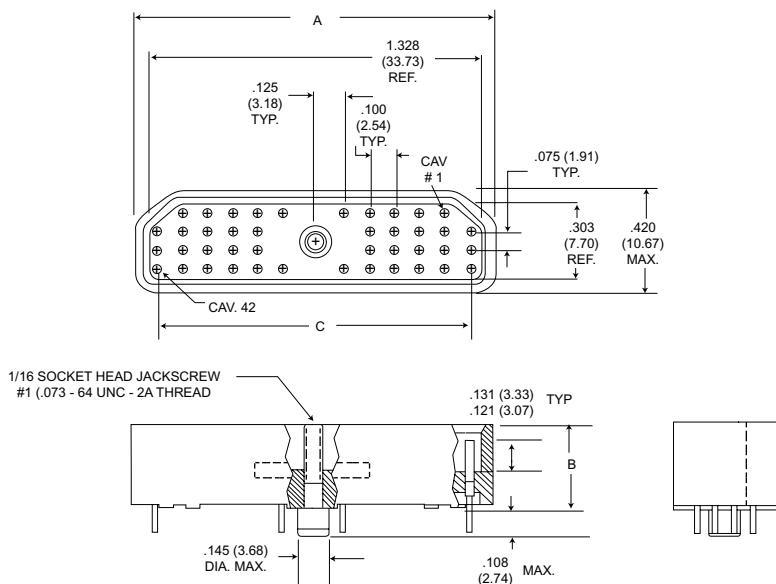

Part Number	A Max.	B Max.	C Ref.	D ±.006 (0.15)
MJSR-42P	1.445 (36.70)	.345 (8.76)	1.250 (31.75)	.142 (3.61)
MJSR-42S	1.445 (36.70)	.357 (9.07)	1.250 (31.75)	-

STANDARD MATERIALS AND FINISHES

Micropin	Copper alloy, 50 micro-inch gold
Microsocket	Copper alloy, 50 micro-inch gold
Insulator	Polyphenylene sulfide, black color
Jackscrew	Stainless steel, passivated & lubricated
Retainer, Jackscrew	Stainless steel, passivated
Insert, Threaded	Stainless steel, passivated
Post, Polarizing	Stainless steel, passivated

Shrouded Receptacle (76)

MJSR-76P

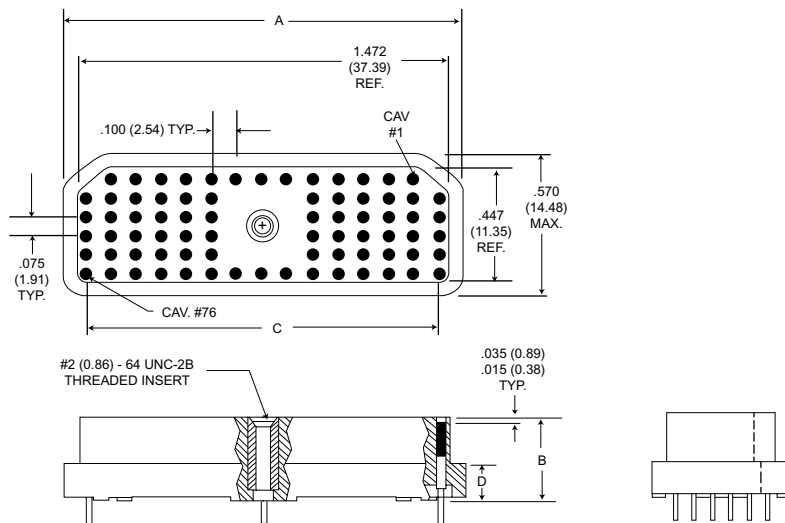

MJSR-76S

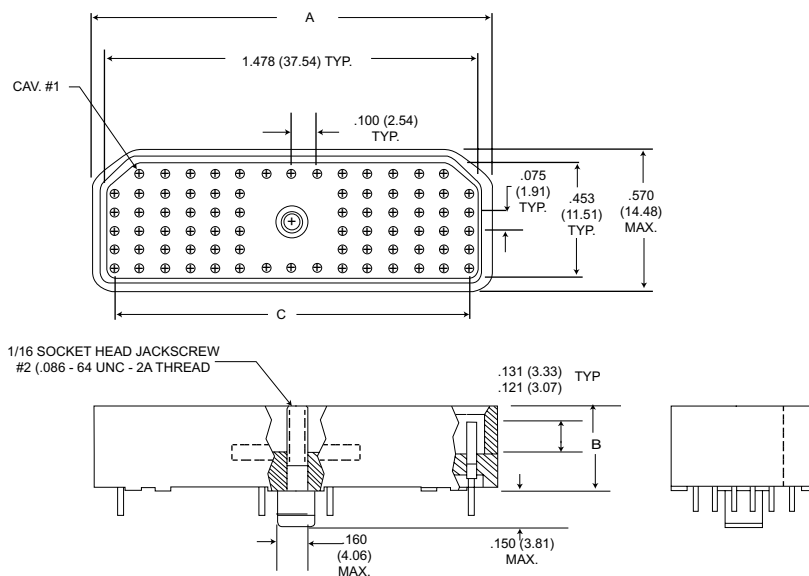

Part Number	A Max.	B Max.	C Ref.	D ±.006 (0.15)
MJSR-76P	1.595 (40.51)	.345 (8.76)	1.400 (35.56)	.142 (3.61)
MJSR-76S	1.595 (40.51)	.357 (9.07)	1.400 (35.56)	-

STANDARD MATERIALS AND FINISHES

Micropin	Copper alloy, 50 micro-inch gold
Microsocket	Copper alloy, 50 micro-inch gold
Insulator	Polyphenylene sulfide, black color
Jackscrew	Stainless steel, passivated & lubricated
Retainer, Jackscrew	Stainless steel, passivated
Insert, Threaded	Stainless steel, passivated
Post, Polarizing	Stainless steel, passivated

Plug (Molded-In Insert - Special)

MJSV**P

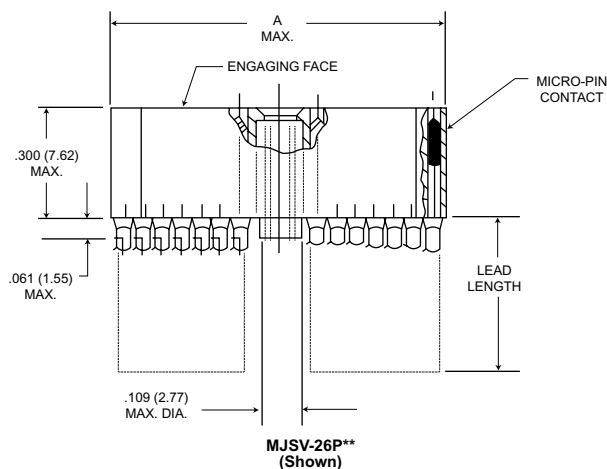
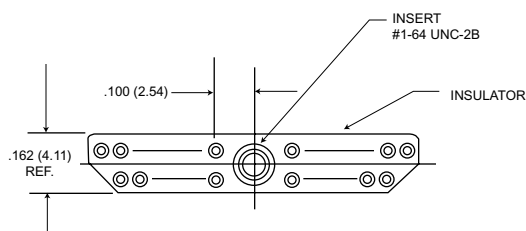

Part Number	A Ref.
MJSV-26P**	.868 (22.05)
MJSV-38P**	1.168 (29.67)

Receptacle (Special)

MJSV**S*

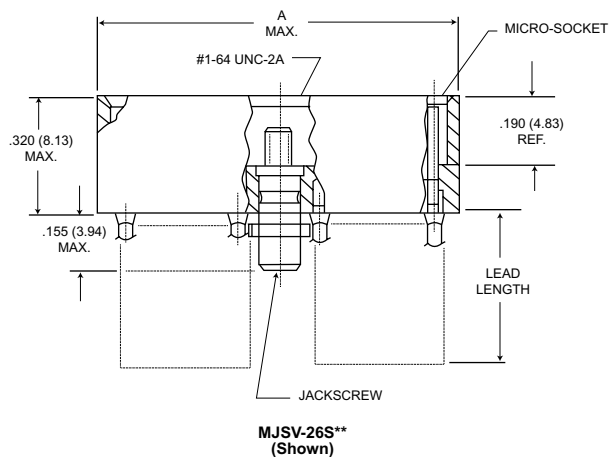
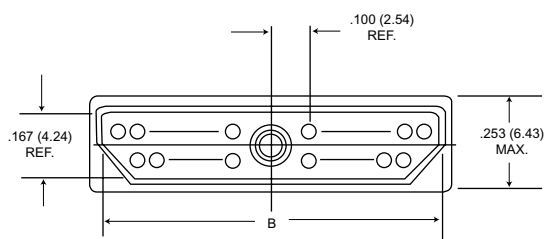

Part Number	A Max.	B Ref.
MJSV-26S**	.943 (23.95)	.874 (22.20)
MJSV-38S**	1.243 (31.57)	1.174 (29.82)

Contact Arrangements

Face view of pin - use reverse order for socket

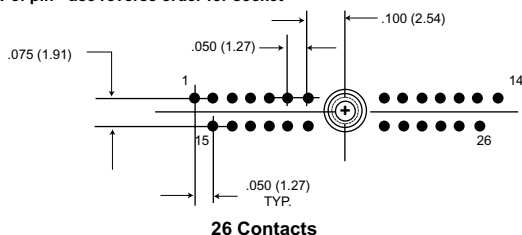

26 Contacts

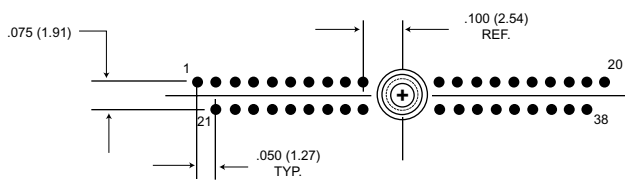

38 Contacts

Identification numbers are for reference and do not appear on connectors.

MICRO-K microminiature circular connectors are rugged yet lightweight - and meet or exceed the applicable requirements of MIL-C-83513. Applications include computers, biomedical, instrumentation and miniature black boxes.

MIK: Accommodate up to 55 contacts on .050 (1.27) centers (equivalent to 420 contacts per square inch). Five keyway polarization prevents cross plugging. The threaded coupling nuts provide strong, reliable coupling. MIK receptacles can be either front or back panel mounted; in back mounting applications, panel thickness of up to 3/32" can be used on the larger sizes. Maximum temperature range - 55°C to + 105°C.

Standard MIK connectors are available in two shell sizes accommodating two contact arrangements pre-wired to your specific requirements.

MIKM: Similar to our MIK, except has a steel shell and receptacle for improved ruggedness and RFI resistance. It accommodates up to 85 twist pin contacts. Maximum temperature range - 55°C to + 105°C.

MIKQ: A quick disconnect metal shell and receptacle version that can be instantaneously disconnected yet provides a solid lock when engaged. Applications include commercial TV cameras, portable

radios, military gun sights, airborne landing systems and medical equipment. Maximum temperature range - 55°C to +125°C.

MIKQP (All Plastic): A lightweight, low-cost, all-plastic version of the MIKQ connector. The MIKQP design withstands the corrosive effects of soil, alkaline and chemicals commonly found in military, industrial and medical environments. It also has been ruggedized for use in impact applications.

For other variations of the basic MIK circular design, contact your nearest ITT Cannon field sales office or call our Microminiature Products Group.

How to Order

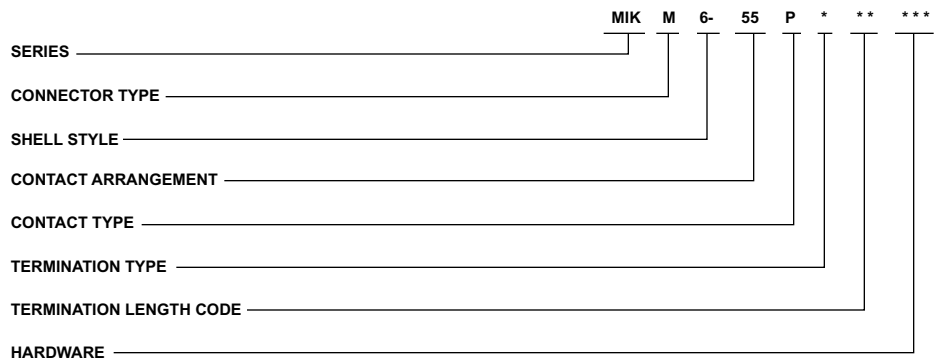

SERIES

MIK: Microminiature Circular

CONNECTOR TYPES

- No Letter - Screw coupling, plastic shell
- M - Screw coupling, metal shell
- Q - Push/Pull, metal shell

SHELL STYLES

- 0 - Wall mounting receptacle (MIK and MIKM only)
- 6 - Straight plug (MIK, MIKM and MIKQ)
- 7 - Jam nut mount (MIKQ only)
- 9 - Rear panel mounted receptacle (MIKQ)

CONTACT ARRANGEMENTS

7, 19, 37, 55, 85

CONTACT TYPE

- P - Pin
- S - Socket

TERMINATION TYPES

- H - Insulated round hook-up wire
- L - Uninsulated round solid wire

TERMINATION LENGTH CODE (STANDARDS)

- (H) 001 - 18", 7/34 strand, #26 AWG, MIL-W-16878/4, Type E Teflon, yellow.
- (H) 003 - 18", 7/34 strand, #26 AWG, MIL-W-16878/4, Type E Teflon, color coded to MIL-STD-681 System I.
- (L) 1 - 1/2" uninsulated solid #25 AWG gold plated copper.
- (L) 2 - 1" uninsulated solid #25 AWG gold plated copper.

HARDWARE

- G - Cable nut and grip (MIKQ plug only)
- N - Nut only (MIKQ plug only)

NOTE: Contact types cannot be interchanged between shell styles.

See page 267 for MIKQP (All Plastic) ordering information.

Performance Specifications

STANDARD MATERIAL AND FINISHES

	MIK	MIKM	MIKQ	MIKQP (All Plastic)
Shell	Thermoplastic	Stainless Steel	Brass	Ultem
Coupling Nut	Stainless Steel	Stainless Steel	Brass, Electroless	Plastic
	Passivated	Passivated	Nickel Plated*	
Insulator	Glass-reinforced	Glass-reinforced	Glass-reinforced	Ultem
	Thermoplastic	Thermoplastic	Thermoplastic	
Contacts	50 Microinch	50 Microinch	50 Microinch	50 Microinch
	Gold Plated	Gold Plated	Gold Plated	Gold Plated
	Copper Alloy	Copper Alloy	Copper Alloy	Copper Alloy

*For plug only
Electrodeposited for receptacle.

ELECTRO/MECHANICAL FEATURES

	MIK	MIKM	MIKQ	MIKQP (All Plastic)
No. of Contacts	7,55	7,55, 85	7,19, 37	11, 19
Wire Size	#26 AWG	#26 AWG	#26 AWG	#26 AWG
	thru #32 AWG	thru #32 AWG	thru #32 AWG	thru #32 AWG
Contact Termination	Crimp	Crimp	Crimp	Crimp
Contact Rating	3 Amps	3 Amps	3 Amps	3 Amps
Coupling	Threaded	Threaded	Push/Pull	Push/Pull
Polarization	Keyways	Keyways	Keyways	Keyways
Contact Spacing	.050 (1.27)	.050 (1.27)	.050 (1.27)	.050 (1.27)
	Centers	Centers	Centers	Centers
Shell Styles	0-Wall Mtg.	0-Wall Mtg.	7-Jam Nut	6-Straight Plug
	6-Straight Plug	6-Straight Plug	6-Straight Plug	9-Rear Panel
			9-Rear Panel	Mtg. Receptacle
			Mtg. Receptacle	

Standard Wire Termination Codes

The following termination codes are listed for your information. For lengths not shown, consult factory for proper modification code. All wire lengths are minimum.

HARNESS TYPES (H)

#26 AWG per MIL-W-16878 Type E, Teflon Stranded

Length	-All Yellow	Color Coded
3 (76.2)	020	027
6 (152.4)	019	016
8 (203.2)	026	034
10 (254.0)	029	025
12 (304.8)	028	002
18 (457.2)	001	003
20 (508.0)	038	023
24 (609.6)	009	004
30 (762.0)	010	005
36 (914.4)	011	006
48 (1219.2)	013	048
72 (1828.8)	017	046
120 (3048.0)	042	041

Contact Arrangements

Face View, Pin Side-(Male Twist Pin Contacts)

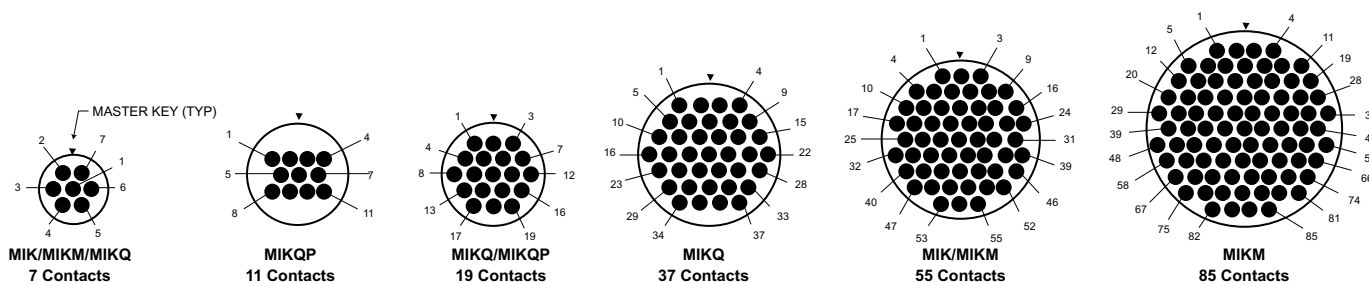

Cavity identification numbers are for reference only, they do not appear on connectors.

Shell Dimensions

MIK (Rear Panel Mount Thickness - see Tabulation "T")

Weight given is 1/2" uninsulated, solid #25 AWG gold plated copper pigtails

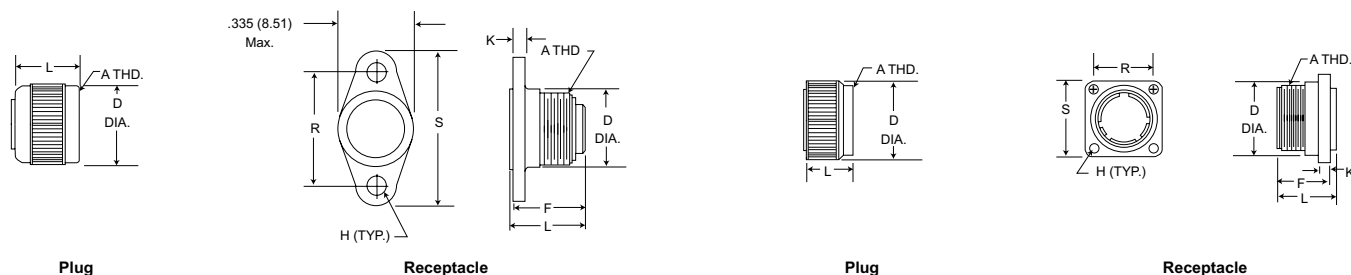

Plug

Part Number by Shell Size	A Thread	D Max.	L Max.	Avg. Weight oz. (gm.) ±5%
MIK6-7P	5/16-24UNF-2B	.375 (9.52)	.315 (8.00)	.054 (1.54)
MIK6-55P	9/16-24UNF-2A	.755 (19.18)	.460 (11.68)	.202 (5.72)

Receptacle

Part Number by Shell Size	A Thread	D ± .010 (0.25)	F Max.	H ± .003 (0.08)	K ± .010 (0.25)	L Max.	R ± .005 (0.13)	S Max.	T Max.	Avg. Weight oz. (gm.) ± 5%
MIKO-7S	5/16-24UNF-2B	.325 (8.26)	.315 (8.00)	.078 (1.98)	.062 (1.57)	.355 (9.02)	.460 (11.68)	.630 (16.00)	.032 (0.81)	.022 (.635)
MIKO-55S	9/16-24UNF-2A	.625 (15.88)	.440 (11.18)	.089 (2.26)	.100 (2.54)	.495 (12.57)	.580 (14.73)	.760 (19.30)	.062 (1.57)	.134 (3.81)

Shell Dimensions (Continued)

MIKM (Rear Panel Mount Thickness .335 (8.51) max. - see Tabulation "T")

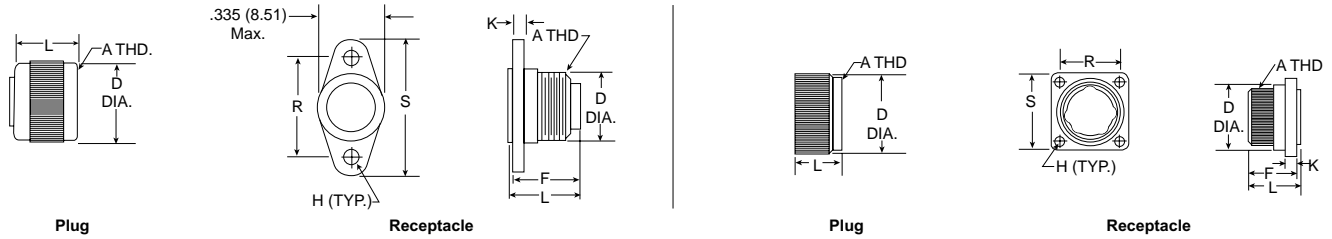

Plug

Part Number by Shell Size	A Thread	D Max.	L Max.	Avg. Weight oz. (gm.)±5%
MIKM6-7P	5/16-24UNF-2A	.375 (9.52)	.315 (8.00)	.054 (1.54)
MIKM6-55P	5/8-24UNEF-2B	.775 (19.18)	.440 (11.18)	.333 (9.44)
MIKM6-85P	11/16-24UNEF-2B	.860 (21.84)	.460 (11.68)	.419 (11.88)

Receptacle

Part Number by Shell Size	A Thread	D	F Max.	H ±.003 (0.08)	K	L Max.	R ±.005 (0.13)	S Max.	T Max.	Avg. Weight oz. (gm.)±5%
MIKM0-7S	5/16-24UNF-2A	.325 (8.26)	.320 (8.13)	.078 (1.98)	.062 (1.57)	.400 (10.16)	.460 (11.68)	.630 (16.00)	.032 (0.81)	.051 (1.45)
MIKM0-55S	5/8-24UNEF-2A	.625 (15.88)	.440 (11.18)	.091 (2.31)	.062 (1.57)	.490 (12.45)	.580 (14.73)	.760 (19.30)	.125 (3.18)	.269 (7.62)
MIKM0-85S	11/16-24UNEF-2A	.745 (18.92)	.440 (11.18)	.091 (2.31)	.062 (1.57)	.490 (12.45)	.674 (17.12)	.845 (21.46)	.125 (3.18)	.346 (9.80)

MIKQ (Front Panel Mounting Type Shown-.093 (2.36) Thickness)

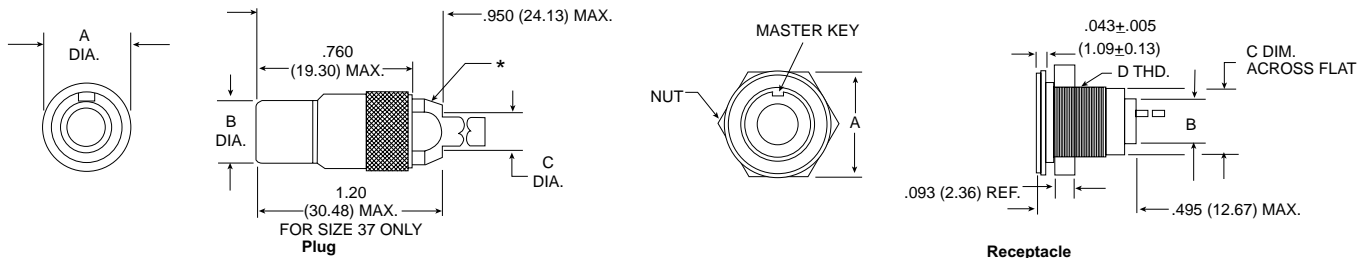

Plug

Part Number by Shell Size	A MAX.	B MAX.	C Ref.	Avg. Weight oz. (gm.)±5%
MIKQ6-7S	.385 (9.78)	.305 (7.75)	.180 (4.57)	.214 (6.08)
MIKQ6-19S	.515 (13.08)	.405 (10.29)	.260 (6.60)	.376 (10.70)
MIKQ6-37S	.760 (19.30)	.635 (16.13)	.350 (8.89)	.714 (20.23)

*Std. Conn. not supplied with Cable Nut & Grip, See Mod Codes.

Lanyard Release Is Available. Consult factory.

Receptacle

Part Number by Shell Size	A MAX.	B MAX.	C MAX.	D Thread	Avg. Weight oz. (gm.)±5%
MIKQ6-7S	.510 (12.95)	.245 (6.22)	.359 (9.12)	3/8-32UNEF-2A	.128 (3.63)
MIKQ7-19P	.575 (14.60)	.345 (8.76)	.470 (11.94)	1/2-28UNEF-2A	.214 (6.08)
MIKQ7-37P	.855 (21.71)	.520 (13.20)	.740 (18.80)	3/4-20UNEF-2A	.300 (8.52)

MIKQ Front Panel Mounting

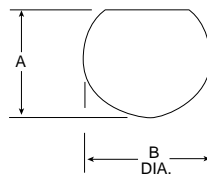

Front Panel Mounting-MIKQ7

Shell Size	A ±.005 (0.13)	B DIA.
MIKQ7-7P	.364 (9.24)	.390 (9.91)
MIKQ7-19P	.475 (12.06)	.515 (13.08)
MIKQ7-37P	.740 (18.78)	.755 (19.17)

Shell Dimensions (Continued)

MIKQ9-7P (Back Panel Mounting)

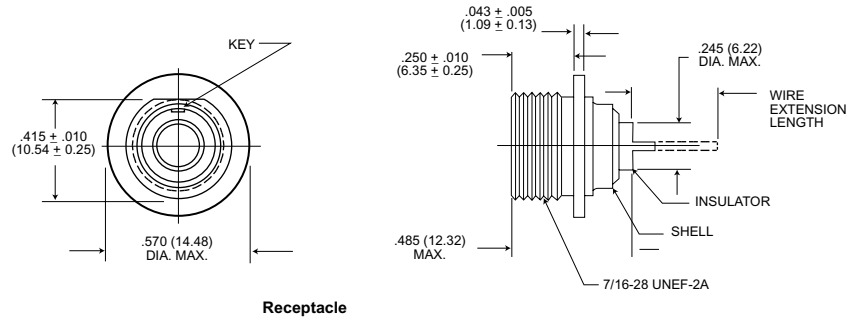

Receptacle

MIKQ9-19P (Back Panel Mounting)

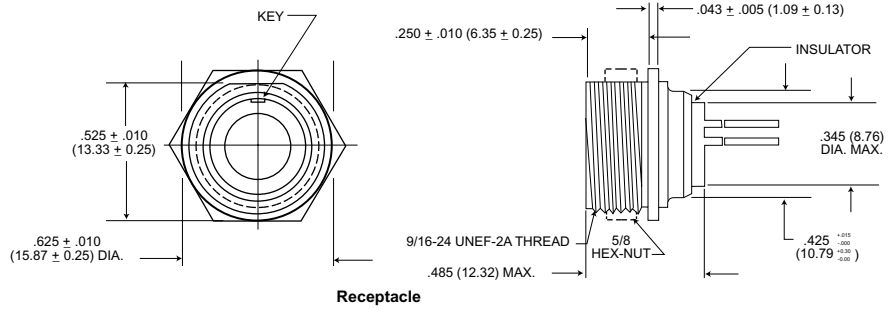

Receptacle

MIKQ9-37P (Back Panel Mounting)

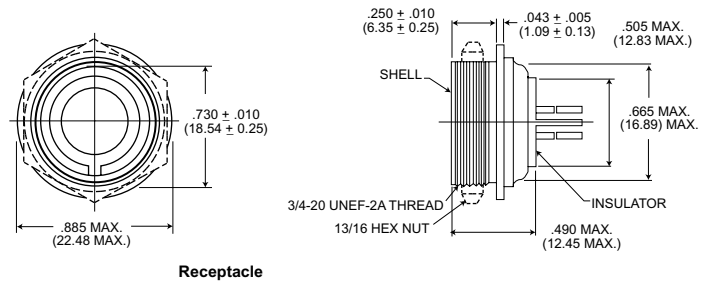

Receptacle

MIKQ Rear Panel Mounting

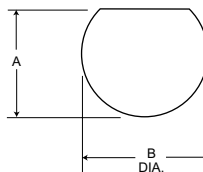

Rear Panel Mounting-MIKQ9

Shell Size	A $\pm .005$ (0.13)	B Dia.
MIKQ9-7P	.425 (10.76)	.440 (11.18)
MIKQ9-19P	.535 (13.58)	.564 (14.33)
MIKQ9-37P	.740 (18.78)	.755 (19.17)

How to Order - MIKQP

All Plastic



SERIES DESIGNATOR ———— MIK Q P 9 - 11 P H ***
 MIK-Microminiature Circular

CLASS ————
 Q - Quick Release (Push Pull)

MATERIAL DESIGNATOR ————
 P - All Plastic

SHELL STYLE ————
 9 - Rear Panel mounted receptacle
 6 - Cable plug

CONTACT ARRANGEMENT ————
 Number of contacts: 11 & 19

CONTACT STYLE ————
 P - Pin (Receptacle)
 S - Socket (Plug)

TERMINATION TYPE ————
 H - Insulated harness wire
 L - Uninsulated solid lead

MODIFICATION CODE ————
 Consult "L" and "H" modification codes for lead material and length.
 For special/custom termination, consult factory.

Shell Dimensions

MIKQP
 11 & 19 Contacts

Plug

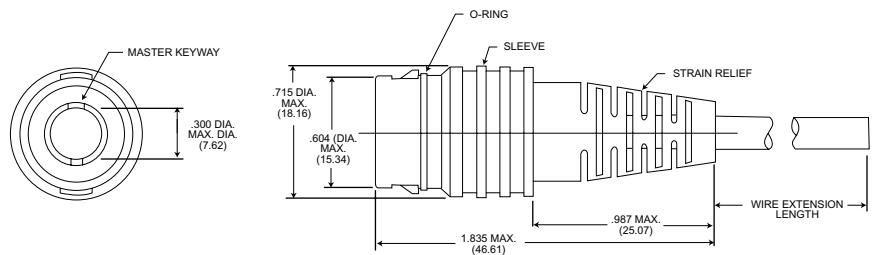

Receptacle

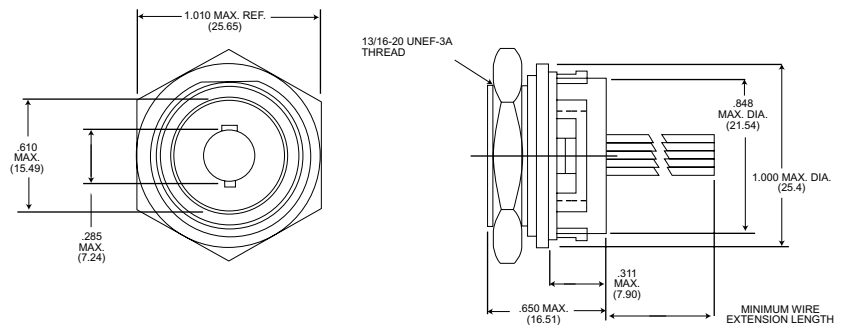

MIKQP Panel Mounting

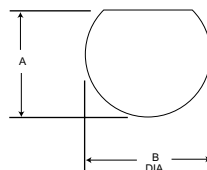

Shell Style	A ± .005 (0.13)	B Dia.
MIKQ9	.853 (21.67)	.887 (22.53)
	.848 (21.54)	.882 (22.40)

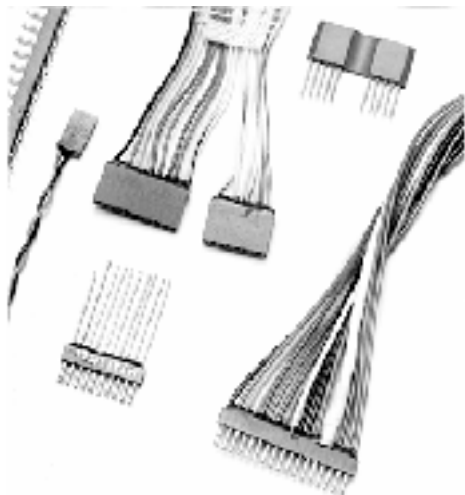

Printed Circuit Board and Card Mounting Frame Applications. Contacts on .050(1.27) centers.

50-MIL STRIP microminiature connectors are designed for space and weight saving applications in a space conscious industry. The strip configuration provides an extremely dense and reliable interconnection device in a minimum profile package, giving great application flexibility.

These connectors are available in many combinations of length, contact spacing and terminations to give designers maximum latitude in their packaging and interconnection solutions. They have been used successfully on printed circuit boards and card mounting frames. Because of its configuration, the 50-MIL STRIP connector is particularly suited for

mounting with high strength epoxy adhesive. In lengths over 2" (50.80) guides, rails or other systems should be used to assure alignment.

50-MIL STRIP connectors use either a flexible insulator of polyester that can be mounted on curved surfaces up to a radius of approximately eight inches, or a more rigid insulator of diallyl phthalate-giving the connector a higher temperature capability. Up to 120 micropin contacts can be held in a single strip on .050(1.27) centers. Guide pins and polarizing devices are available. Special termination with hookup wire is available to meet specific customer requirements. Crimping hookup wire to contacts before they are inserted is often desirable in high density contact arrangements. Color coded wires of any length in sizes #26 thru #30 AWG solid and #26 thru #30 AWG stranded can be harnessed by the factory.

How to Order

SERIES AND MATERIALS

- MTB - Glass filled diallyl phthalate (149°C)
- MTV - Glass filled polyester (125°C)

CONTACT SPACING

- 1 - .050 (1.27) centers, MTB1 and MTV1 only
- 2 - .100 (2.54) centers, MTB2 and MTV2 only

NUMBER OF INSULATOR CAVITIES

- MTV1 - 120 Max.
- MTV2 - 60 Max.
- MTB1 - 81 Max.
- MTB2 - 41 Max.

CONTACT TYPE

- P - Pin
- S - Socket

TERMINATION TYPE

- L - Uninsulated solid pigtail
- H - Insulated † *
- S - Solder pots
- AL - PCB pigtail termination ***
PCB termination code***

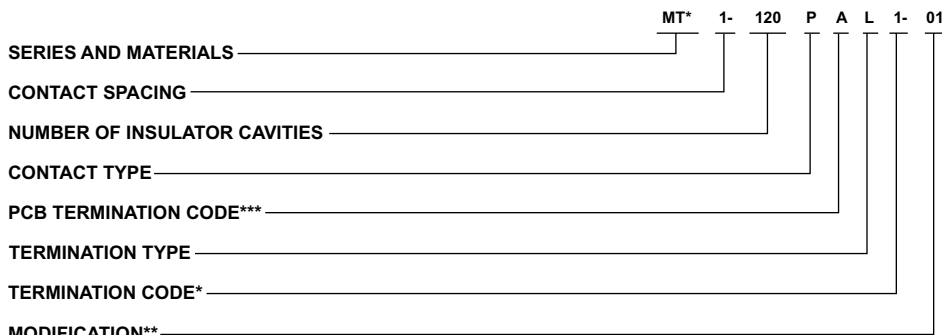

TERMINATION CODE*

- (H) 001 - 18", 7/34 strand, #26 AWG, MIL-W-16878/4, Type E Teflon, yellow.
- (H) 003 - 18", 7/34 strand, #26 AWG, MIL-W-16878/4, Type E Teflon, color coded to MIL-STD-681 System I.
- (L) 1 - 1/2" uninsulated solid #25 AWG gold plated copper.
- (L) 2 - 1" uninsulated solid #25 AWG gold plated copper.

MODIFICATION**

- 01 - Guide posts each end of socket strip-blank cavities each end of pinstrips.

*See Termination Codes for additional length modification codes.
 **Consult factory for variations from standard not shown.
 ***PCB terminations performed at 90° increments of .050" (1.27) to bend from rear of insulator on solid uninsulated leads are available. Consult factory for proper ordering nomenclature.
 †NOTE: MT Strips are not to be terminated with insulated wire in more than 41 cavities without added backpotting support on socket side.

Standard Wire Termination Codes

The following termination codes are listed for your information. For lengths not shown, consult factory for proper modification code. All wire lengths are minimum.

Harness Type - (H)

#26 AWG per MIL-W-16878 Type E; Teflon Stranded

Length	All Yellow	Color Coded
3 (76.2)	H020	H027
6 (152.4)	H019	H016
8 (203.2)	H026	H034
10 (254.0)	H029	H025
12 (304.8)	H028	H002
18 (457.2)	H001	H003
20 (508.0)	H033	H023
24 (609.6)	H009	H004
30 (762.0)	H010	H005
36 (914.4)	H011	H006
48 (1219.2)	H013	H048
72 (1828.5)	H017	H046
120 (3048.0)	H042	H041

Solid Uninsulated Type - (L)

#25 AWG Gold Plated Copper

Termination Code	Length
L61	.125 (3.18)
L56	.150 (3.81)
L57	.190 (4.83)
L39	.250 (6.35)
L58	.375 (9.52)
L1	.500 (12.70)
L14	.750 (19.05)
L2	1.000 (25.40)
L7	1.500 (38.10)
L6	2.000 (50.80)
L16	2.500 (63.50)
L10	3.000 (76.20)

Performance and Material Specifications

WEIGHT

		lbs.	gms.
Contact (with std. 1/2" copper pigtails)	pin	.000088	.040
	socket	.000088	.040
Insulator (per contact cavity)	MTB	pin	.000046 .021
		socket	.000013 .006
	MTV	pin	.000031 .014
		socket	.000009 .004
Guide Post	Stainless Steel	.000079	.035

MATERIALS AND FINISHES

One-piece insulator:	MTB: glass-filled dially phthalate MTV: glass-filled polyester
Contacts:	Copper alloy, gold plate

MECHANICAL FEATURES

No. of Contacts;	MTV:120 max. MTB:81 max.
Wire Size:	Solid: #24 thru #30 AWG Stranded: #26 thru #30 AWG
Contact Termination:	Crimp Stationary
Size or Length:	MTV: 6.04" (153.42) max. "yardage" MTB: 4.09" (103.89) max. "yardage"
Coupling:	Friction
Polarization:	Guide posts
Contact Spacing	
Centers:	.050" (1.27) and .100" (2.54)

LENGTH

Contact cavities in 50-MIL STRIP connectors are in a single row and located on .050" (1.27) centers or increments thereof. MTV connectors can be supplied in lengths up to 6.04 inches (157.42) with a maximum of 120 contacts on .050" (1.27) centers. MTB connectors can be supplied in lengths up to 4.09 inches (103.89) with a maximum of 81 contacts on .050" (1.27) centers. Lengths of connectors can be calculated as follows:

$$L = \text{number of contacts times } .050 \text{ (1.27) plus } .020 \text{ (0.51)}$$

EXAMPLE:

50 contacts (installed in each cavity):

$$L = (50 \times .050") + .020" = 2.52" \text{ length of strip}$$

$$L = (50 \times 1.27\text{mm}) + (0.51\text{mm}) = (64.01\text{mm}) \text{ length of strip}$$

NOTES: MT not to be terminated with insulated wire in more than 41 cavities without adding backpotting support on socket side.

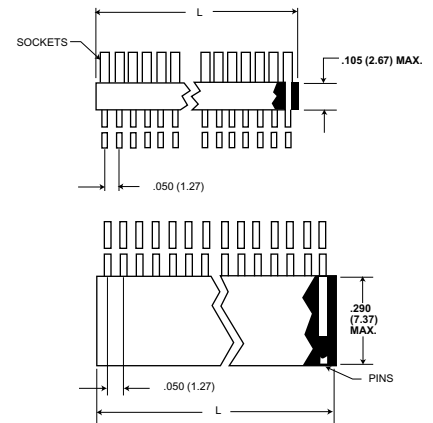

Test Data

CONTACT RESISTANCE

Test give constant resistance readings from 10µa to 3 amps on individually mated contacts. The maximum allowable contact resistance, measured on the wire at the rear of the contact, is 8 milliohms. The average contact resistance is 6 milliohms.

Current Rating - 3 amps max.

Max. Voltage Drop - 24 millivolts at 3 amps.

Average Voltage Drop - 12 millivolts at 3 amps.

Low Level Contact Resistance - Measured voltage drop is .24 x 10⁻⁶ volts at 10 x 10⁻⁶ amps.

DIELECTRIC WITHSTANDING VOLTAGE

Min. Flashover voltage (at room temp.) at 60 cps rms 50% R.H.

Sea Level - 900 VAC, 70,000 feet. - 250 VAC

Solder Pot Contacts

Sea Level - 600 VAC, 70,000 feet-150 VAC

VIBRATION AND SHOCK

No discontinuity detected (in excess of 1 micro second) after twelve 15-min. sweeps from 10 to 2000 cps at .060" (1.52mm) double aptitude or 20g, or after twenty shocks of 50g. Connectors were mounted to simulate service condition. Test conducted to MIL-STD-202, Method 204A, Condition D and Method 213, Condition G.

TEMPERATURE RANGE

MTB: - 55°C to +149°C

MTV: - 55°C to +125°C

ENGAGING AND SEPARATING FORCE

For an individual contact the maximum engaging force is 8 ounces (226.80 grams). Minimum separating force is 0.5 ounces (14.17 grams) per contact. Test conducted using min./max. bushings.

SALT SPRAY

No damage or unacceptable increase in contact resistance after mated sample subjected to 48 hours of salt spray per MIL-STD-202, Method 101C, 5% solution, Condition B.

CONTACT AND INSERT RETENTION

Over 5 lbs. (2.72 kg.) min. axial load.

PCB Terminations

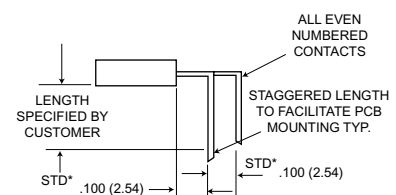
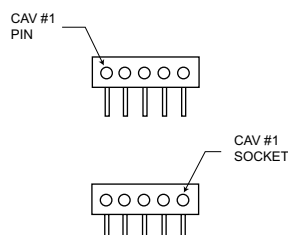

*Consult factory for variations.

Dimensions are shown in inches (millimeters).
Dimensions subject to change.

www.ittcannon.com

Polarization



Modification code "-01" in the part number refers to guide posts located on both ends of the socket beside of the 50-MIL STRIP connector and blank cavities on the pin side to accept the guide posts.

Although in many cases it is not necessary to polarize 50-MIL STRIP connectors, there are several ways to prevent cross plugging. One method is the use of guide posts that can be located in specified cavities to assure that the contacts will align when these post are positioned before mating.

MTB1 and MTV1 - .050 (1.27) Contact Centers

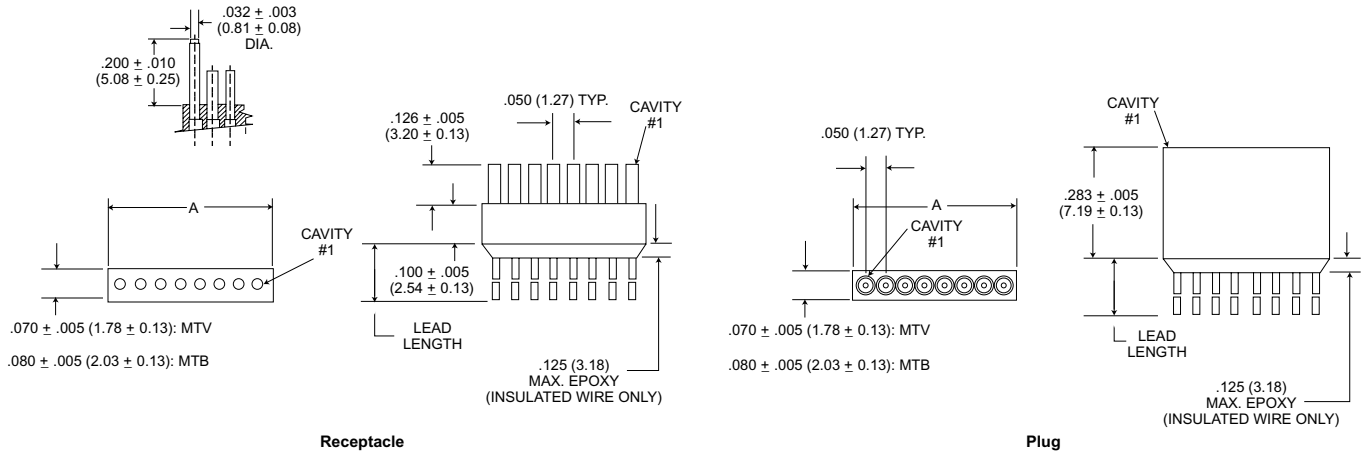

Part Number by Size	A ±.015 (0.38)	Part Number by Size	A ±.015 (0.38)	Part Number by Size	A ±.015 (0.38)	Part Number by Size	A ±.015 (0.38)	Part Number by Size	A ±.015 (0.38)	Part Number by Size	A ±.015 (0.38)
MT*1-1**	.070 (1.78)	MT*1-21**	1.070 (27.18)	MT*1-41**	2.070 (52.58)	MT*1-61**	3.070 (77.98)	MT*1-81**	4.070 (103.38)	MT*1-101**	5.070 (128.78)
MT*1-2**	.120 (3.05)	MT*1-22**	1.120 (28.45)	MT*1-42**	2.120 (53.85)	MT*1-62**	3.120 (79.25)	MT*1-82**	4.120 (104.65)	MT*1-102**	5.120 (130.05)
MT*1-3**	.170 (4.32)	MT*1-23**	1.170 (29.72)	MT*1-43**	2.170 (55.12)	MT*1-63**	3.170 (80.52)	MT*1-83**	4.170 (105.92)	MT*1-103**	5.170 (131.32)
MT*1-4**	.220 (5.59)	MT*1-24**	1.220 (30.99)	MT*1-44**	2.220 (56.39)	MT*1-64**	3.220 (81.79)	MT*1-84**	4.220 (107.19)	MT*1-104**	5.220 (132.59)
MT*1-5**	.270 (6.85)	MT*1-25**	1.270 (32.36)	MT*1-45**	2.270 (57.66)	MT*1-65**	3.270 (83.06)	MT*1-85**	4.270 (108.46)	MT*1-105**	5.270 (133.86)
MT*1-6**	.320 (8.13)	MT*1-26**	1.320 (33.53)	MT*1-46**	2.320 (58.93)	MT*1-66**	3.320 (84.33)	MT*1-86**	4.320 (109.73)	MT*1-106**	5.320 (135.13)
MT*1-7**	.370 (9.40)	MT*1-27**	1.370 (34.80)	MT*1-47**	2.370 (60.20)	MT*1-67**	3.370 (85.60)	MT*1-87**	4.370 (111.00)	MT*1-107**	5.370 (136.40)
MT*1-8**	.420 (10.67)	MT*1-28**	1.420 (36.07)	MT*1-48**	2.420 (61.47)	MT*1-68**	3.420 (86.87)	MT*1-88**	4.420 (112.27)	MT*1-108**	5.420 (137.67)
MT*1-9**	.470 (11.94)	MT*1-29**	1.470 (37.34)	MT*1-49**	2.470 (62.74)	MT*1-69**	3.470 (88.14)	MT*1-89**	4.470 (113.54)	MT*1-109**	5.470 (138.94)
MT*1-10**	.520 (13.60)	MT*1-30**	1.520 (38.61)	MT*1-50**	2.520 (64.01)	MT*1-70**	3.520 (89.41)	MT*1-90**	4.520 (114.81)	MT*1-110**	5.520 (140.21)
MT*1-11**	.570 (14.48)	MT*1-31**	1.570 (39.88)	MT*1-51**	2.570 (65.28)	MT*1-71**	3.570 (90.68)	MT*1-91**	4.570 (116.08)	MT*1-111**	5.570 (141.48)
MT*1-12**	.620 (15.75)	MT*1-32**	1.620 (41.15)	MT*1-52**	2.620 (66.55)	MT*1-72**	3.620 (91.95)	MT*1-92**	4.620 (117.35)	MT*1-112**	5.620 (142.75)
MT*1-13**	.670 (17.02)	MT*1-33**	1.670 (42.42)	MT*1-53**	2.670 (67.82)	MT*1-73**	3.670 (93.22)	MT*1-93**	4.670 (118.62)	MT*1-113**	5.670 (144.02)
MT*1-14**	.720 (18.29)	MT*1-34**	1.720 (43.69)	MT*1-54**	2.720 (69.09)	MT*1-74**	3.720 (94.49)	MT*1-94**	4.720 (119.89)	MT*1-114**	5.720 (145.29)
MT*1-15**	.770 (19.56)	MT*1-35**	1.770 (44.96)	MT*1-55**	2.770 (70.36)	MT*1-75**	3.770 (95.76)	MT*1-95**	4.770 (121.16)	MT*1-115**	5.770 (146.56)
MT*1-16**	.820 (20.83)	MT*1-36**	1.820 (46.23)	MT*1-56**	2.820 (71.63)	MT*1-76**	3.820 (97.03)	MT*1-96**	4.820 (122.43)	MT*1-116**	5.820 (147.83)
MT*1-17**	.870 (22.10)	MT*1-37**	1.870 (47.50)	MT*1-57**	2.870 (72.90)	MT*1-77**	3.870 (98.30)	MT*1-97**	4.870 (123.70)	MT*1-117**	5.870 (149.10)
MT*1-18**	.920 (23.37)	MT*1-38**	1.920 (48.77)	MT*1-58**	2.920 (74.17)	MT*1-78**	3.920 (99.57)	MT*1-98**	4.920 (124.97)	MT*1-118**	5.920 (150.37)
MT*1-19**	.970 (24.64)	MT*1-39**	1.970 (50.04)	MT*1-59**	2.970 (75.44)	MT*1-79**	3.970 (100.84)	MT*1-99**	4.970 (126.24)	MT*1-119**	5.970 (151.64)
MT*1-20**	1.020 (25.91)	MT*1-40**	2.020 (51.31)	MT*1-60**	3.020 (76.71)	MT*1-80**	4.020 (102.11)	MT*1-100**	5.020 (127.50)	MT*1-120**	6.020 (152.91)

NOTE: MTB1 available in up to 81 contacts.

MTB2 and MTV2 - .100 (2.54) Contact Centers

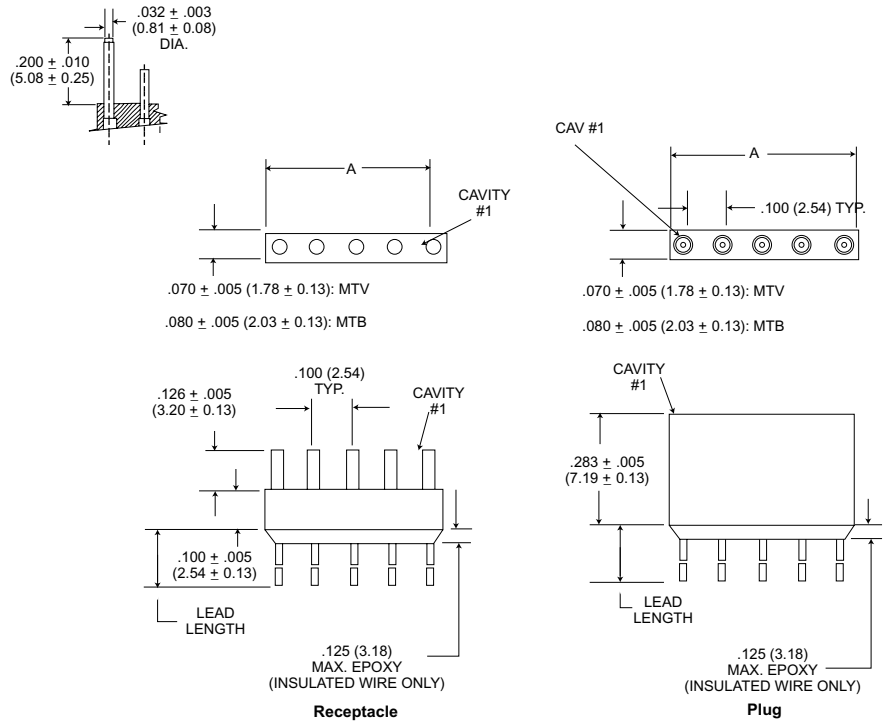

Part Number by Size	A ±.015 (0.38)	Part Number by Size	A ±.015 (0.38)
MT*2-1**	.070 (1.78)	MT*2-31**	3.070 (77.98)
MT*2-2**	.170 (4.32)	MT*2-32**	3.170 (80.52)
MT*2-3**	.270 (6.86)	MT*2-33**	3.270 (83.06)
MT*2-4**	.370 (9.40)	MT*2-34**	3.370 (85.60)
MT*2-5**	.470 (11.94)	MT*2-35**	3.470 (88.14)
MT*2-6**	.570 (14.48)	MT*2-36**	3.570 (90.68)
MT*2-7**	.670 (17.02)	MT*2-37**	3.670 (93.22)
MT*2-8**	.770 (19.56)	MT*2-38**	3.770 (95.76)
MT*2-9**	.870 (22.10)	MT*2-39**	3.870 (98.30)
MT*2-10**	.970 (24.64)	MT*2-40**	3.970 (100.84)
MT*2-11**	1.070 (27.18)	MT*2-41**	4.070 (103.38)
MT*2-12**	1.170 (29.72)	MT*2-42**	4.170 (105.92)
MT*2-13**	1.270 (32.26)	MT*2-43**	4.270 (108.46)
MT*2-14**	1.370 (34.80)	MT*2-44**	4.370 (111.00)
MT*2-15**	1.470 (37.34)	MT*2-45**	4.470 (113.54)
MT*2-16**	1.570 (39.88)	MT*2-46**	4.570 (116.08)
MT*2-17**	1.670 (42.42)	MT*2-47**	4.670 (118.62)
MT*2-18**	1.770 (44.96)	MT*2-48**	4.770 (121.16)
MT*2-19**	1.870 (47.50)	MT*2-49**	4.870 (123.70)
MT*2-20**	1.970 (50.04)	MT*2-50**	4.970 (126.24)
MT*2*21**	2.070 (52.58)	MT*2*51**	5.070 (128.78)
MT*2-22**	2.170 (55.12)	MT*2-52**	5.170 (131.32)
MT*2-23**	2.270 (57.66)	MT*2-53**	5.270 (133.86)
MT*2-24**	2.370 (60.20)	MT*2-54**	5.370 (136.40)
MT*2-25**	2.470 (62.74)	MT*2-55**	5.470 (138.94)
MT*2-26**	2.570 (65.28)	MT*2-56**	5.570 (141.48)
MT*2-27**	2.670 (67.82)	MT*2-57**	5.670 (144.02)
MT*2-28**	2.770 (70.36)	MT*2-58**	5.770 (146.56)
MT*2-29**	2.870 (72.90)	MT*2-59**	5.870 (149.10)
MT*2-30**	2.970 (75.44)	MT*2-60**	5.970 (151.64)

The Micro Edgeboard (MEB) connector series provides a combination of high density and high reliability for applications in airborne and space systems, computers and peripherals, and industrial/commercial control systems. This series incorporates the proven MICROPIN™/MICROSOCKET™ contact. This contact has an outstanding record of high reliability and millions of contacts are in use in various applications where electrical interconnects are used.

The MEB has machined aluminum shells for ruggedness, diallyl phthalate insulator for top electrical performance and a 36-position polarization key system to prevent cross plugging. Contacts are on .050 (1.27) center spacings. A variety of termina-

tion types are available, including 90° pigtailed for multi-layered P.C. boards, "coke bottle" termination for double-sided P.C. boards, and .025 (0.64) square wire wrap post termination. Harnessing capability is also available for both pin and socket sides.

The MEB, including the SBR 90° variation available for multi-layer boards, can be mounted on the female (daughter) side of double or single-sided P.C. boards. The mating male (mother) board side can have the terminations formed to meet the application demands. Wire-wrapping, using .025 X .025 (0.64 X 0.64) square posts is also available.

Conforms to MIL-C-55302/120 thru 123.

How to Order

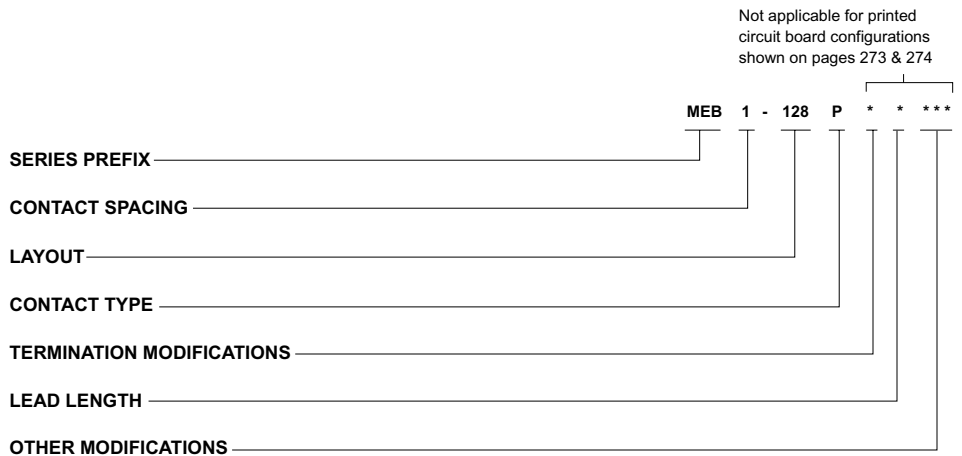

SERIES PREFIX

- MEB - Micro edgeboard, plug with twist pin contacts or recept. with microsocket contacts.
- MEBL - Micro edgeboard, plug with stamped Low Insertion Force (LIF) contacts. Pin side only.

CONTACT SPACING

- 1 - .050 (1.27) centers 128/184
- 2 - .100 (2.54) centers 64/92 (alternate contact holes)

LAYOUT

- 64, 92, 128, 184

CONTACT TYPE

- P - Pin
- S - Socket

* For other contact spacing accommodations consult factory.

TERMINATION MODIFICATIONS

- L - Uninsulated solid wire
- H - Insulated stranded round harness wire
- S - Solder pots
- BR - PC board right angle, socket side only
- W - Wire wrap post, pin side only

LEAD LENGTH

Consult factory for wire lead modification codes.

OTHER MODIFICATIONS

Consult factory

Performance and Material Specifications

MATERIALS AND FINISHES

Shell:	6061-T6 Aluminum Alloy per QQ-A-200/8 or QQ-A-225/8, electroless nickel per MIL-C-26074, Class 4, grade A except .0010 to .0015 (0.03 to 0.04) thick or conversion coating per MIL-C-5541, Class 3, color gold.
Contact, Pin and Socket:	Copper Alloy, 50 microinch gold per MIL-G-45204, Type II, Class 1, over copper flash
Jackscrew/Jackpost:	303 stainless steel, passivated per QQ-P-35.
Insulator:	Glass-filled diallyl phthalate per MIL-M-14, Type SDG-F, color green Polyester per MIL-M-24519, Type GET-30F, color black available for MEB-12B upon request.

TERMINATION TYPES

Consult factory for stranded wire lead modifications codes.

MECHANICAL FEATURES

Size or Length:	2 sizes
Coupling:	Friction/Jackscrew
Polarization:	Shells, polarizing keys (36 positions)
Contact Spacing Centers:	.050 (1.27)
Shell Styles:	Plug and receptacle

Plug (Mother Board)

MEB1-128 or MEBL1-128BP

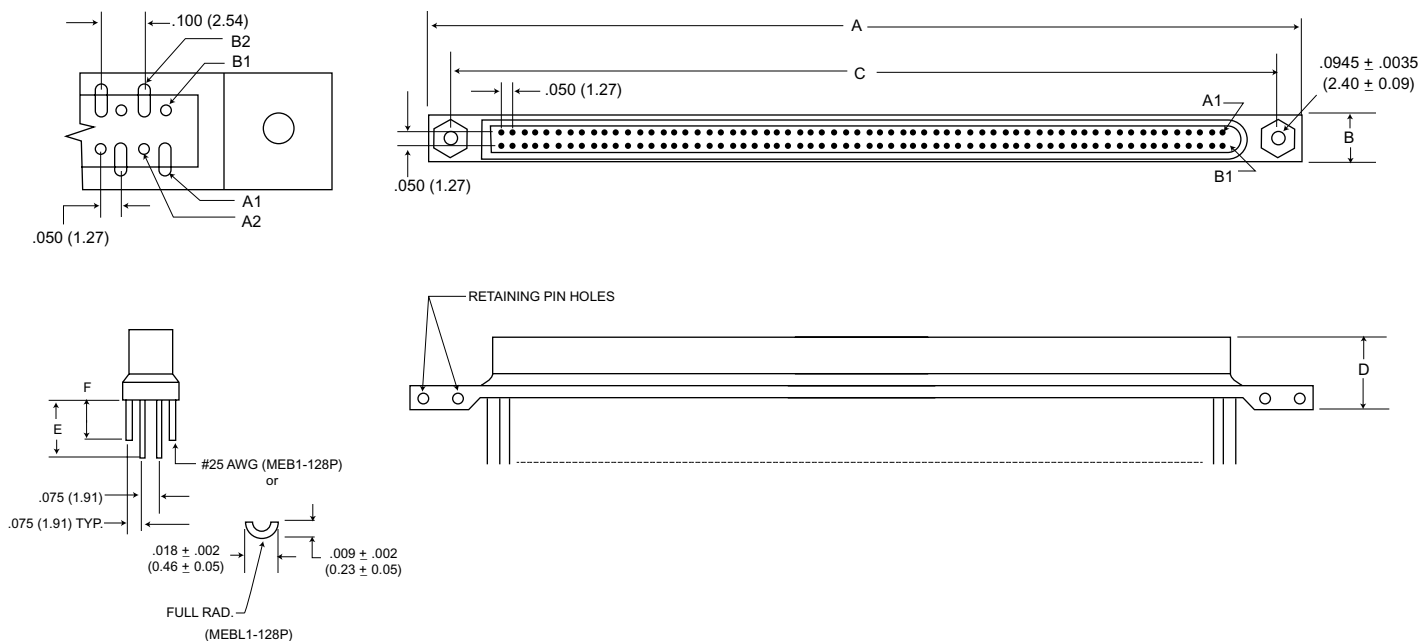

Part No.	Weight oz. (gm.) Max.	A ±.015 (0.38)	B ±.010 (0.25)	C ±.010 (0.25)	D ±.010 (0.25)	E ±.025 (0.64)	F ±.025 (0.64)
128P	.5 (14.17)	3.950 (100.33)	.250 (6.35)	3.700 (93.98)	.400 (10.16)	.350 (8.89)	.275 (6.99)
128PW	1.5 (42.52)						

Receptacle (Daughter Board)

MEB1-12BS

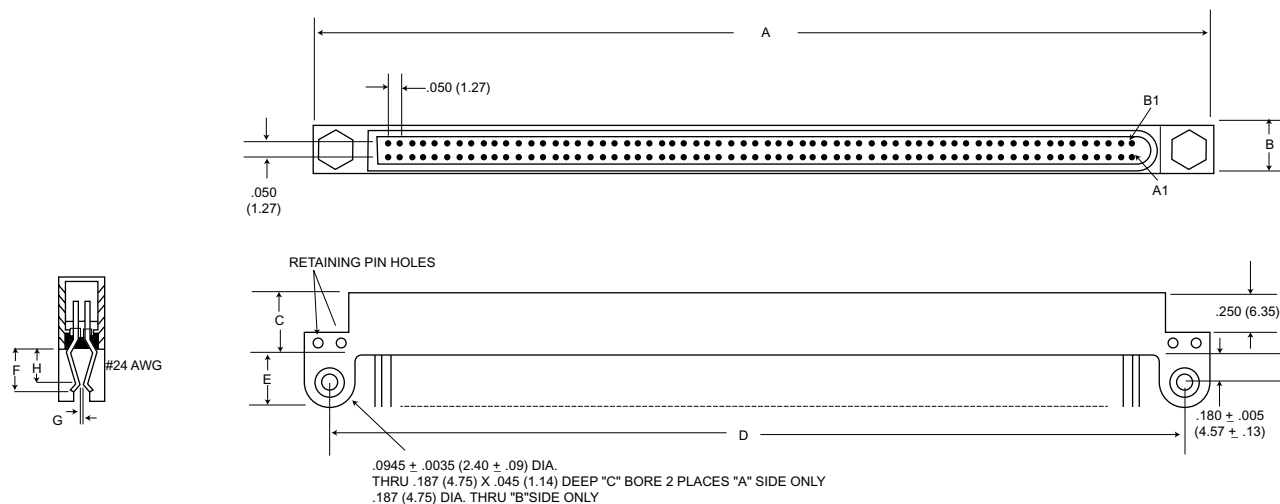

Part No.	Weight oz. (gm.) Max.	A ±.015 (0.38)	B ±.010 (0.25)	C ±.010 (0.25)	D ±.010 (0.25)	E ±.010 (0.25)	F Max.	G* Max.	H ±.020 (0.51)
128S	.5 (14.17)	3.950 (100.33)	.250 (6.35)	.400 (10.16)	3.700 (93.98)	.300 (7.62)	.280 (7.11)	.030 (0.76)	.200 (5.08)
128SBR	.5 (14.17)								

*Will accept up to .093 (2.36) thick P.C. Board with shell modifications.

Plug (Mother Board)

MEB1-184P or MEBL1-184P

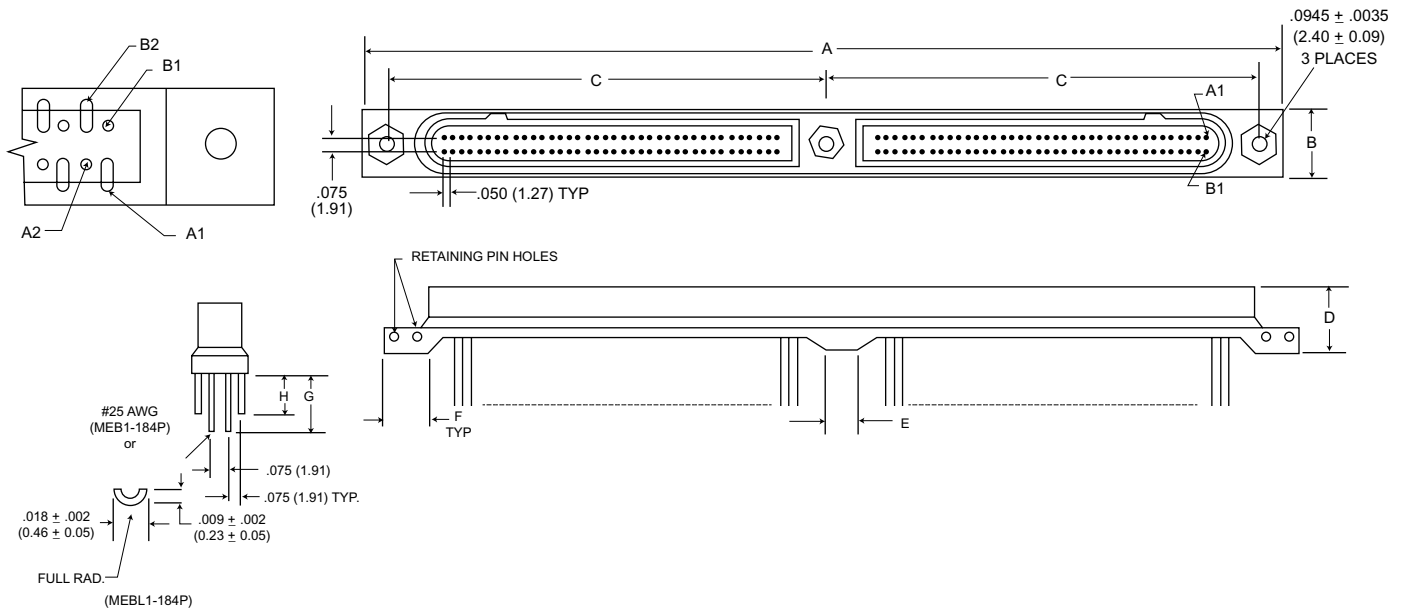

Part No.	Weight oz. (gm.) Max.	A ±.015 (0.38)	B ±.010 (0.25)	C ±.005 (0.13)	D ±.010 (0.25)	E ±.010 (0.25)	F ±.010 (0.25)	G ±.025 (0.64)	H ±.025 (0.64)
184P	1.0 (28.35)	5.800 (147.32)	.343 (8.71)	2.775 (70.49)	.400 (10.16)	.250 (6.35)	.280 (7.11)	.350 (8.89)	.275 (6.99)
184PW	2.0 (56.70)								

Wire-wrap termination similar to the MEB1-128PW wire-wrap will be available for MEB1-184P connector. Consult the factory for specific information.

Receptacle (Daughter Board)

MEB1-184S

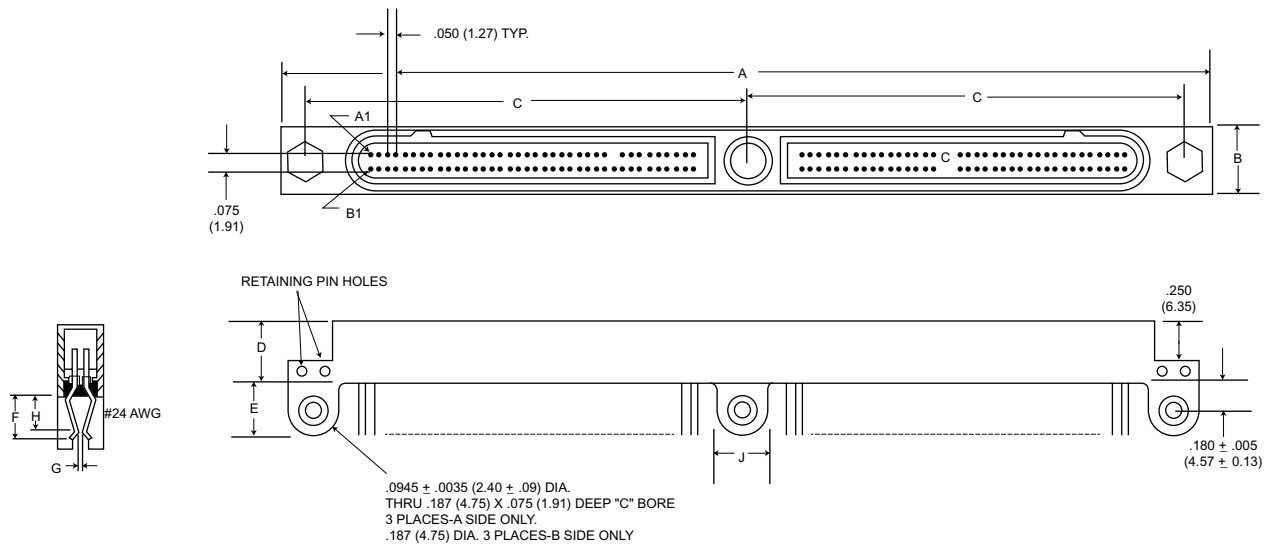

Part No.	Weight oz. (gm.) Max.	A ±.015 (0.38)	B ±.010 (0.25)	C ±.005 (0.13)	D ±.010 (0.25)	E ±.010 (0.25)	F Max.	G Max.	H ±.020 (0.51)	J ±.010 (0.25)
184S	1.0 (28.35)	5.800 (147.32)	.343 (8.71)	2.775 (70.49)	.400 (10.16)	.300 (7.62)	.280 (7.11)	.030 (0.76)	.200 (5.08)	.250 (6.35)
184SBR	1.0 (28.35)									

All round pigtail #25 AWG wire termination designs available for the MEB1-12B receptacle will apply on the MEB1-184 series also.

*Will accept up to .093 (2.36) thick P.C. Board with shell modifications.

Wire Wrap Post

MEB1-128PW

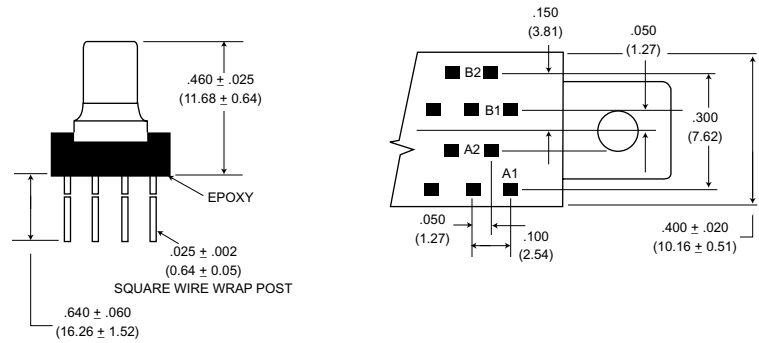

PC Board Right Angle

MEB1-128SBR

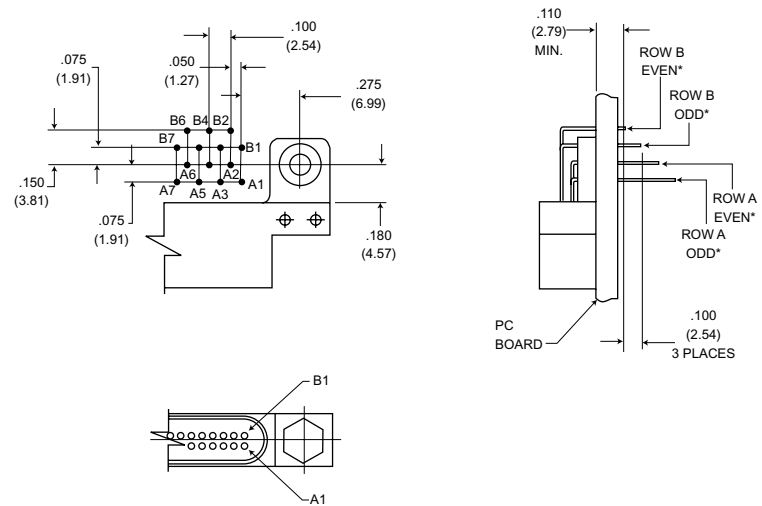

Keying Accessory - Key and Retaining Pin

Polarizing Hardware Kit

MEB-128-P/N 320-9514-003

MEB-184-P/N 320-9514-002

Contains 2 polarizing keys and 4 spiral pins.

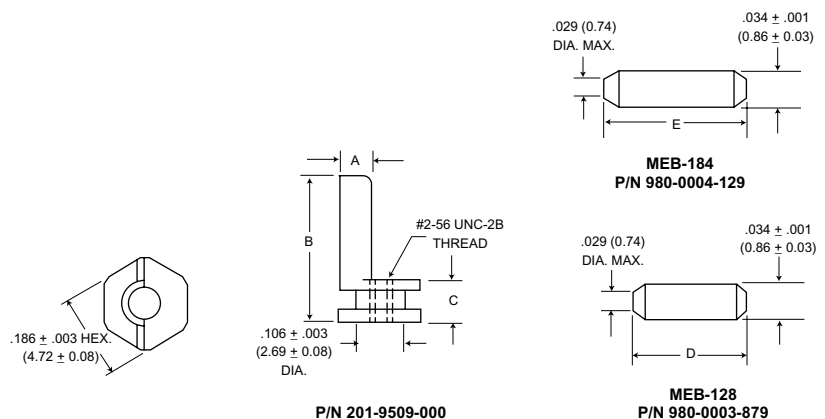

A	B	C	D	E
± .003 (0.08)	± .005 (0.13)	± .003 (0.08)	± .010 (0.25)	± .010 (0.25)
.081 (2.06)	.325 (8.26)	.089 (2.26)	.250 (6.35)	.313 (7.95)

Jackscrew/ Jackpost Assembly (MEB 64 & 128 Sizes Only)

Jackpost Kit

MEB plug or receptacle-P/N 320-9514-001
 Contains 2 bushings and 4 spirals pins

Jackscrew Kit

MEB plug-P/N 320-9521-001
 MEB receptacle-P/N 320-9521-000
 Contains 2 jackscrew assemblies

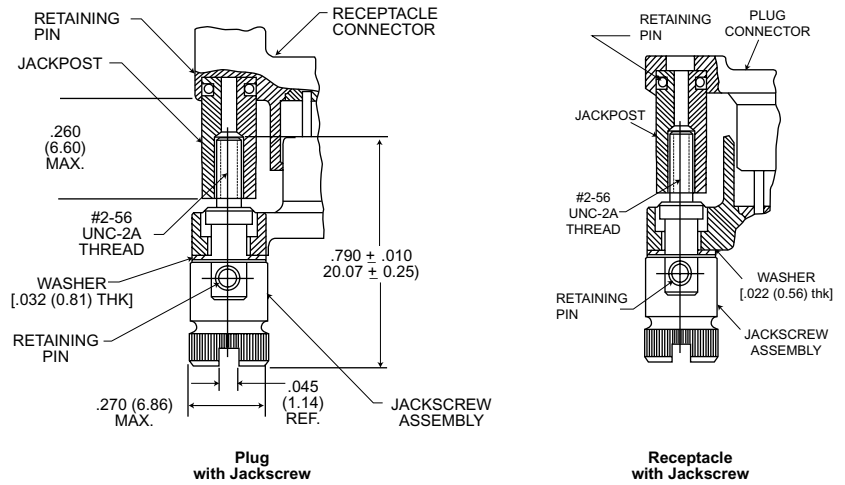

Special Variations

Alternative Plug Lead Configuration

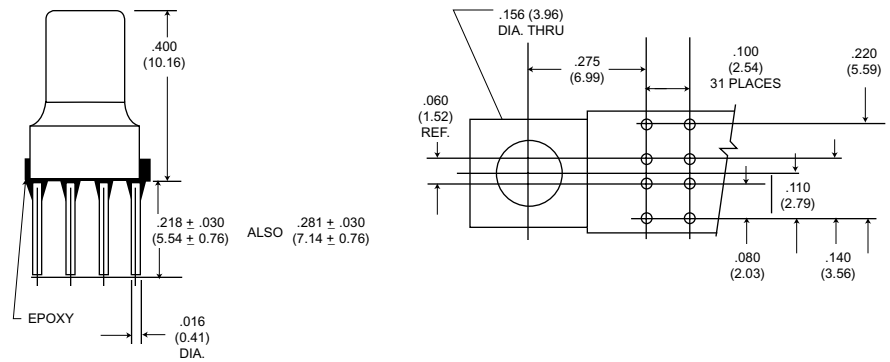

Alternative Receptacle Configuration

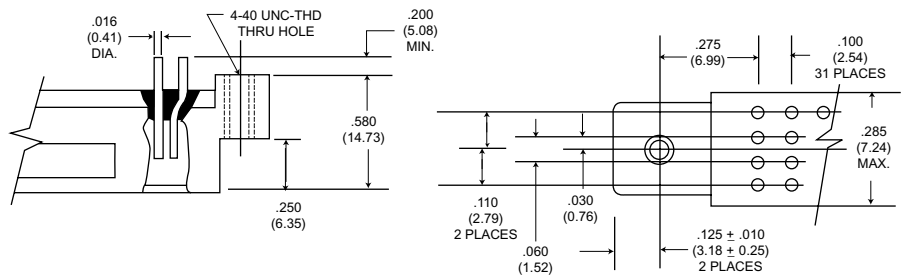

The Centi Line - .075" Contact Spacing



ITT Cannon Centi connectors are especially suitable for commercial applications such as computers, instrumentation, model airplane R/C equipment, calculators, communications and audio equipment. They are available in D subminiature size metal shell rectangular, plastic shell rectangular and strip configurations.

All Centi connectors use the reliable twist pin contact design in a 5 amp version terminated on .075 (1.91) and .100 (2.54) centers. This larger contact is crimp removable, so Centi Series connectors are available in connector kits and as bulk parts for customer assembly. Standard crimp and assembly tools are available.

The twist pin contact is recessed within the insulator housing while the rugged cylindrical socket is exposed. When the connector halves are mated, the chamfered sockets guide the pins into positive alignment. The Centipin™ contact, now under compression, forms a multi-point contact with the Centisocket™ to provide a high degree of reliability.

Standard Data

- Contact rating: 5 amps max, except BR Series (2 amps max.)
- Minimum contact centers: 0.075 (1.91).
- Wire sizes: #22 thru #26 AWG, stranded or solid.
- Contact termination: Multiple indent crimp.
- Contact retention: Crimp snap-in/removable.
- Contact materials and finish: Copper alloy, gold-plated per MIL-G-45204, Type II, Class 0, over copper flash.
- Mating/unmating force: 12 oz. per contact, max.

Performance Specifications

The table below summarizes the results of key tests performed in accordance with MIL-STD-202, where specified. Data is applicable to standard connectors with standard terminations. Variations may affect this data, so please consult the factory for further information on your requirements.

Test	Method	Criteria of Acceptance
Dielectric Withstanding Voltage	Method 301: 1,000 VAC at sea level 300 VAC at 70,000' altitude	No breakdown No breakdown
Insulation Resistance	Method 302, Condition A	5,000 megohms minimum
Thermal Shock	Method 107, Condition A +55°C to +85°C	No physical damage
Physical Shock	Method 213, Condition I: 100 G's, 3 axes, 6 millisecond duration sawtooth pulse	No physical damage No loss of continuity > 1μsec
Vibration	Method 204, Condition B: 15 G's, 10-2,000 Hz, 12 hours	No physical damage No loss of continuity > 1μsec
Durability	500 cycles of mating and unmating, 500 CPH max.	No mechanical or electrical defects
Moisture Resistance	Method 106, Omit 7a and 7b	Insulation resistance > 100 megohms
Salt Spray	Method 101, Condition B: 48 hours	Shall be capable of mating and unmating and meet contact resistance requirements
Contact Resistance	Method 307: At 5 amps	9 milliohms maximum
Contact Retention	-	4 lb. minimum axial load

The Double Density D is a rectangular connector in the popular D Subminiature shell configuration featuring double the contact density in the same insert area. The Double Density D connector can thus accommodate up to 100 contacts instead of 50. This double contact density is achieved by using field-proven, highly reliable Centipin™/Centisocket™ contacts on .075 (1.91) centers, in the positive contact alignment design. In this design contact

positions are reversed; the flexible Centipin™ contacts are recessed in the insulator and the more rugged Centisocket™ contacts are exposed. This reversal of positions, and the chamfered-entry of the sockets, assures positive mating even under severe misalignment conditions. The contacts are retained in the monobloc insulator by a resilient internal shoulder that snaps into a locking groove in the contact. The chamfered front of the contact will

not damage the internal shoulder in the insulator. Contacts are crimp removable type.

The Double Density D connector is available in the five popular shell and insert sizes accommodating up to 100 contacts. These connectors mate exclusively with other Double Density D connectors. A wide range of accessories can be used, including junction shells, potting cups, switching shells, guide pin plates, and dust caps.

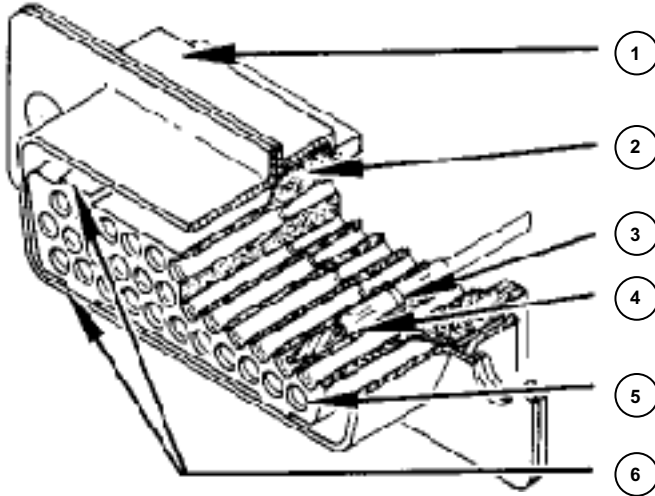

1. STANDARD D HARDWARE-

Including full range of D Subminiature accessories

2. ONE PIECE TYPE INSULATOR-

glass-filled nylon material

3. CONTACT RETENTION-

thermoplastic internal shoulder snaps into a locking groove in the contact.

Retention Force: 8 lbs. min. initially, 4 lbs. min. after 10 cycle.

4. TWIST PIN CONTACTS-

seven outer wiping surfaces assure electrical continuity even under severe shock and vibration

5. POSITIVE CONTACT ALIGNMENT-

flexible pin is recessed in insulator cavity and rugged socket is exposed

6. GUIDE-IN KEYS AND KEYWAYS-

assure alignment during mating and prevent scooping

How to Order

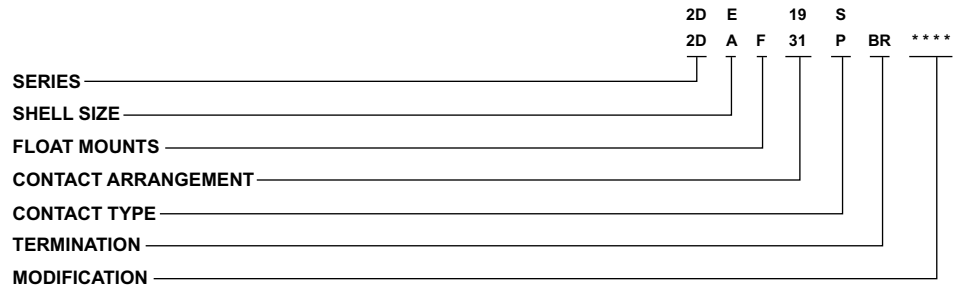

SERIES

2D - Double Density D - ITT Cannon prefix

SHELL SIZE

E, A, B, C and D

FLOAT MOUNTS

Omit if not required

SERIES

SHELL SIZE

FLOAT MOUNTS

CONTACT ARRANGEMENT

CONTACT TYPE

TERMINATION

MODIFICATION

NOTE: Connectors may be ordered less contacts by adding the mod callout "FO" at end of number. Contacts are then supplied in bulk form. For type of contacts and installation/assembly tools refer to page 13.

CONTACT ARRANGEMENT

19, 31, 52, 79 and 100

CONTACT TYPE*

P - Pin
S - Socket

TERMINATION

BR - 90° PCB mounting
(For BR Series use "P" to designate jackpost)

MODIFICATION

F171 - Jackpost assembly
F172 - Standard jackscrew
F173 - Low profile jackscrew
For other modifications consult factory

* Accommodates AWG #26 thru #22

Performance and Material Specifications

WEIGHT

Part Number by shell size	Weight (in gr.)		Weight (in oz.)	
	Less With Contacts	Less With Contacts	Less With Contacts	Less With Contacts
2DE19P	4.05	5.02	.142	.177
2DE19S	3.75	5.17	.133	.182
2DA31P	5.20	6.78	.183	.239
2DA31S	4.90	7.22	.173	.255
2DB52P	8.75	11.40	.308	.402
2DB52S	7.15	11.05	.252	.390
2DC79P	11.70	15.73	.413	.555
2DC79S	9.70	15.62	.342	.551
2DD100P	12.85	17.95	.453	.633
2DD100S	10.95	18.45	.386	.651

MATERIALS AND FINISHES

*Shell	- Steel, cadmium plated with yellow chromate supplementary coating
Mounting Hardware and Float Mounts	- Stainless steel
Insulator	- Glass-filled nylon
Contacts	- Copper alloy, gold plate
Alternate finish,	- A106 Gold over brass
Modification Code	A156 Gold over brass A197 Tin/Lead over steel

*Brass non-magnetic also available

MECHANICAL FEATURES

Sizes	- Five shell sizes: E, A, B, C, and D
Coupling	- Friction or jackscrew
Polarization	- Keystone-shaped shells
Contact Spacing	- .075 (1.91)
Contact Termination	- Crimp snap-in

Standard Shell

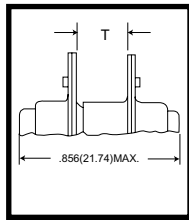
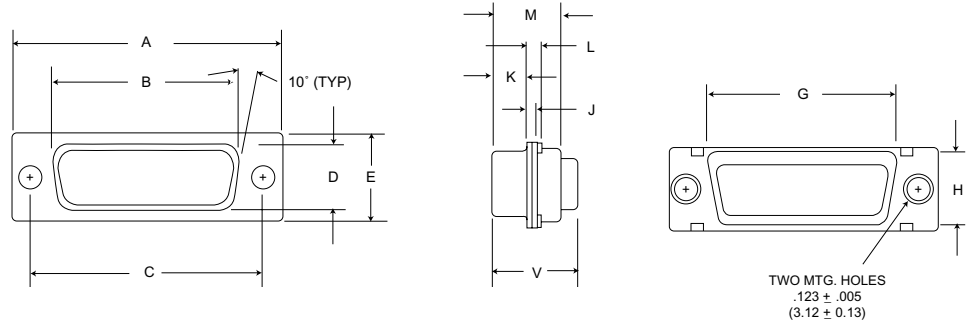

Part Number by Shell Size	T + .020 (0.51) - .000 (0.00)	Part Number by Shell Size	T + .020 (0.51) - .000 (0.00)
2DE19P	.250 (6.35)	2DB52S	.236 (5.99)
2DE19S	.250 (6.35)	2DC79P	.236 (5.99)
2DA31P	.250 (6.35)	2DC79S	.236 (5.99)
2DA31S	.250 (6.35)	2DD100P	.236 (5.99)
2DB52P	.236 (5.99)	2DD100S	.236 (5.99)

Float Mount

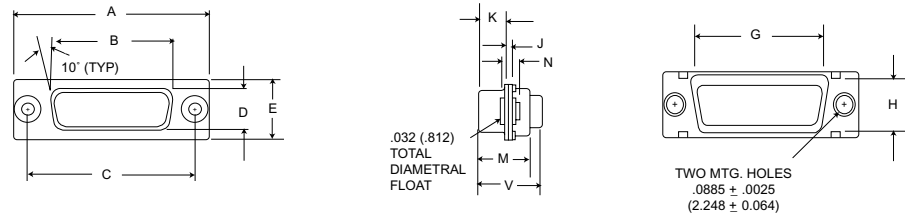

Part Number by Shell Size	A ± .015 (0.38)	B ± .010 (0.25)	C ± .010 (0.25)	D ± .010 (0.25)	E ± .015 (0.38)	G ± .010 (0.25)	H ± .010 (0.25)	J ± .010 (0.25)	K ± .010 (0.25)	L ± .010 (0.25)	M ± .010 (0.25)	N ± .010 (0.25)	V Max.
2DE19P	1.213 (30.81)	.697 (17.70)	.984 (24.99)	.360 (9.14)	.494 (12.55)	.759 (19.28)	.422 (10.72)	.036 (.914)	.236 (5.99)	.055 (1.40)	.422 (10.72)	.120 (3.05)	.555 (14.10)
2DE19S	1.213 (30.81)	.640 (16.26)	.984 (24.99)	.308 (7.82)	.494 (12.55)	.759 (19.28)	.422 (10.72)	.032 (.812)	.243 (6.17)	.047 (1.19)	.429 (10.90)	.120 (3.05)	.555 (14.10)
2DA31P	1.541 (39.14)	1.025 (26.03)	1.312 (33.32)	.360 (9.14)	.494 (12.55)	1.083 (27.51)	.422 (10.72)	.036 (.914)	.236 (5.99)	.055 (1.40)	.422 (10.72)	.120 (3.05)	.555 (14.10)
2DA31S	1.541 (39.14)	.968 (24.58)	1.312 (33.32)	.308 (7.82)	.494 (12.55)	1.083 (27.51)	.422 (10.72)	.032 (.812)	.243 (6.17)	.047 (1.19)	.429 (10.90)	.120 (3.05)	.555 (14.10)
2DB52P	2.088 (53.03)	1.583 (40.21)	1.852 (47.04)	.378 (9.60)	.494 (12.55)	1.625 (41.27)	.422 (10.72)	.036 (.914)	.231 (5.87)	.055 (1.40)	.426 (10.82)	.129 (3.28)	.555 (14.10)
2DB52S	2.088 (53.03)	1.508 (38.30)	1.852 (47.04)	.308 (7.82)	.494 (12.55)	1.625 (41.27)	.422 (10.72)	.032 (.812)	.243 (6.17)	.047 (1.19)	.429 (10.90)	.120 (3.05)	.555 (14.10)
2DC79P	2.729 (69.31)	2.231 (56.67)	2.500 (63.50)	.378 (9.60)	.494 (12.55)	2.272 (57.71)	.422 (10.72)	.036 (.914)	.231 (5.87)	.055 (1.40)	.426 (10.82)	.129 (3.28)	.555 (14.10)
2DC79S	2.729 (69.31)	2.156 (54.76)	2.500 (63.50)	.308 (7.82)	.494 (12.55)	2.272 (57.71)	.422 (10.72)	.032 (.812)	.243 (6.17)	.047 (1.19)	.429 (10.90)	.120 (3.05)	.555 (14.10)
2DD100P	2.635 (66.92)	2.127 (54.02)	2.406 (61.11)	.484 (12.29)	.605 (15.37)	2.178 (55.32)	.534 (13.56)	.036 (.914)	.231 (5.87)	.055 (1.40)	.426 (10.82)	.129 (3.28)	.555 (14.10)
2DD100S	2.635 (66.92)	2.062 (52.37)	2.406 (61.11)	.420 (10.67)	.605 (15.37)	2.178 (55.32)	.534 (13.56)	.032 (.812)	.243 (6.17)	.047 (1.19)	.429 (10.90)	.120 (3.05)	.555 (14.10)

For shell with float mounts, add letter F after shell size, e.g., 2DEF19P.

JackscREW/Jackpost Assembly

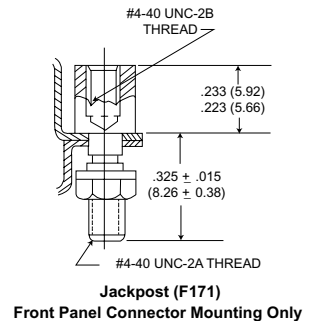
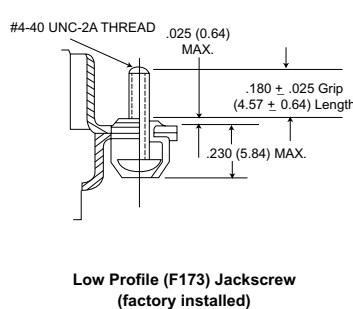
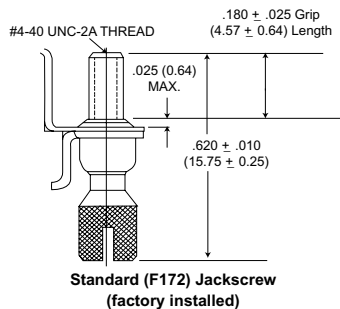

90° PCB Mounting - 4 Row

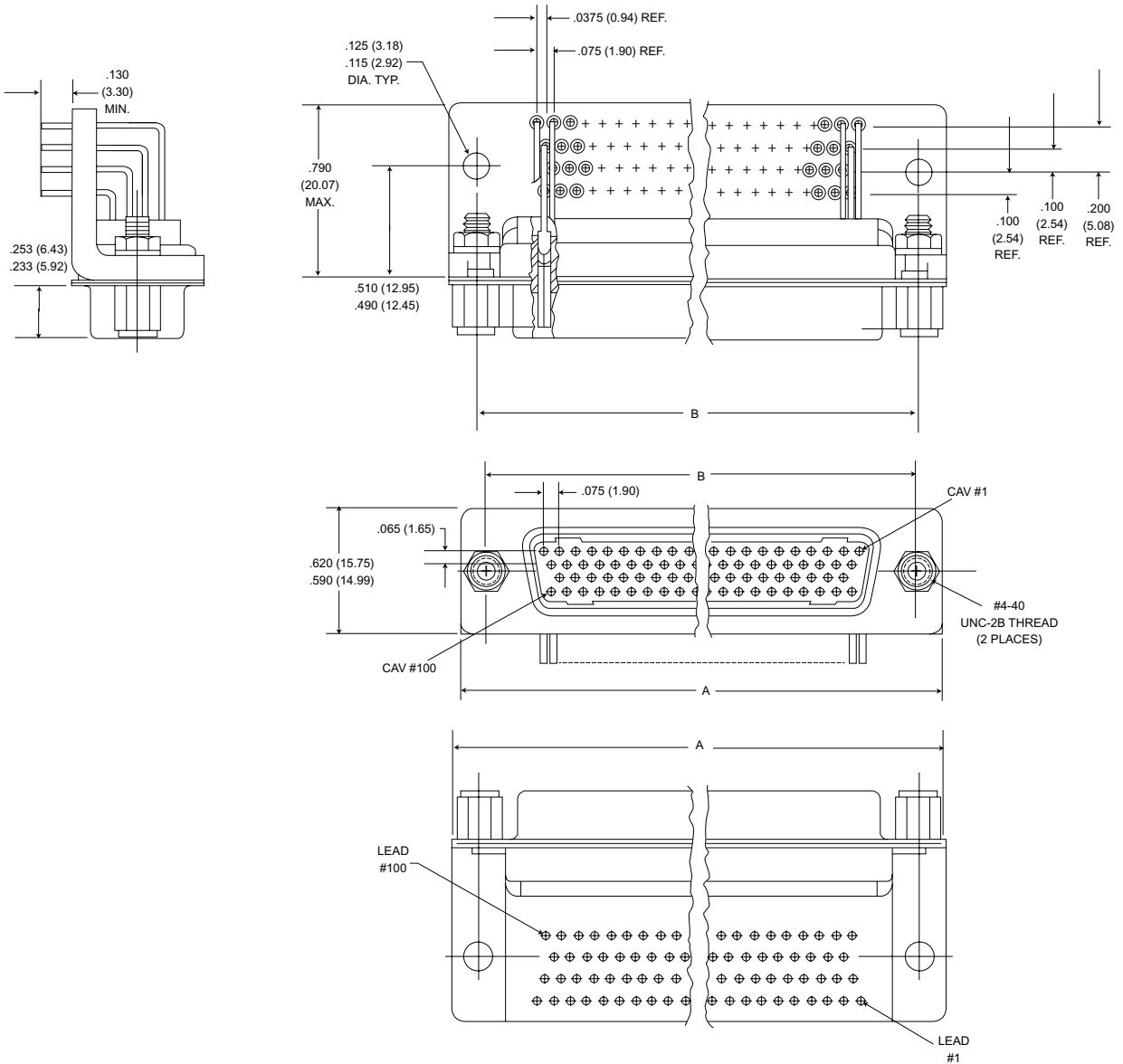

Part Number by Shell Size	A ± .015 (0.38)	B ± .010 (0.25)	C Max.
2DD100SBRP	2.635 (66.93)	2.406 (61.11)	.790 (20.07)

Contact Arrangements

All views are pin front face. Use reverse order for socket side.

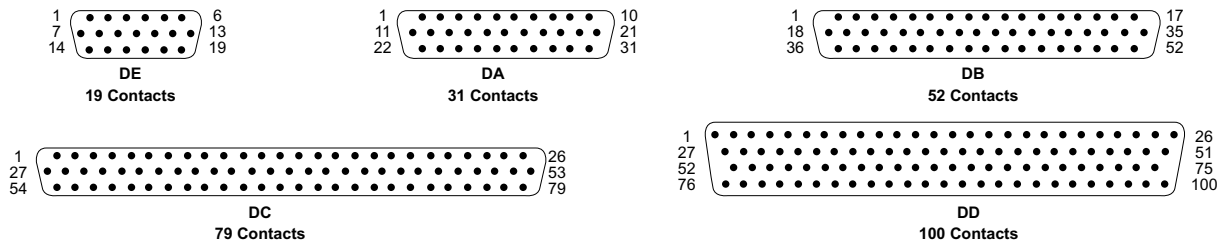

Cavity identification numbers are shown for reference only and do not appear on insulator front face. However they do appear on rear of insulator.

90° PCB Mounting - 3 Row

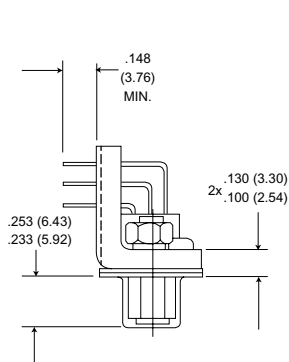

PCB Termination Leads
(all contact arrangements)
.024 (6.10) to .028 (7.11).

Suggested finished PC hole
Size .033 (8.38) ± .003 (0.08)

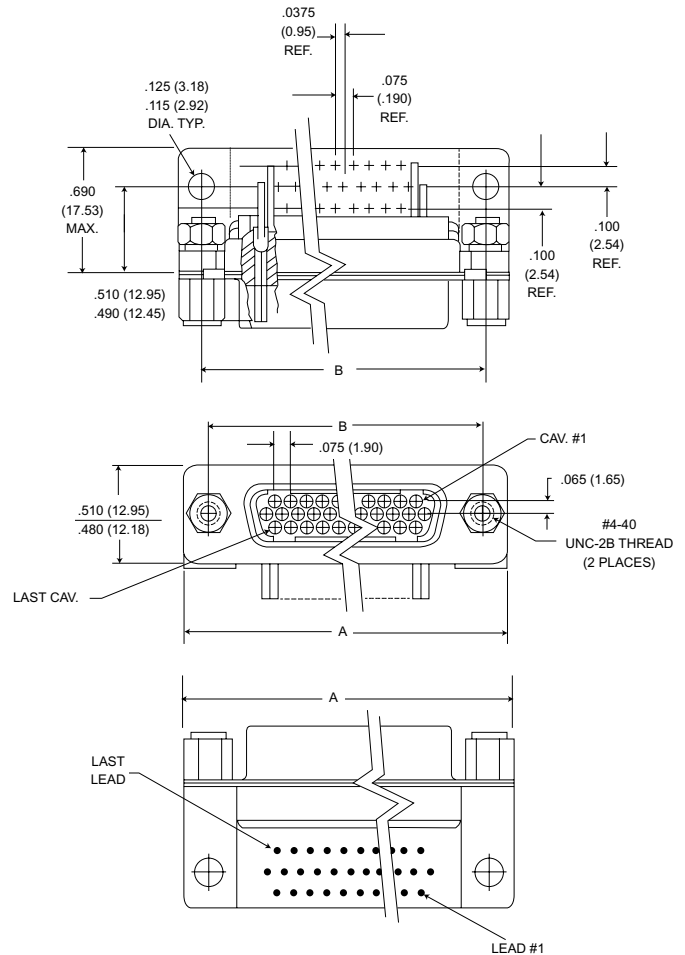

Part Number by Shell Size	A ± .015 (0.38)	B ± .010 (0.25)	C Max.
2DE19SBRP	1.215 (30.86)	.984 (24.99)	.690 (17.53)
2DA31SBRP	1.540 (39.12)	1.312 (33.32)	.690 (17.53)
2DB52SBRP	2.090 (53.09)	1.852 (47.04)	.690 (17.53)
2DC79SBRP	2.730 (69.34)	2.500 (63.50)	.690 (17.53)

Panel Cutouts

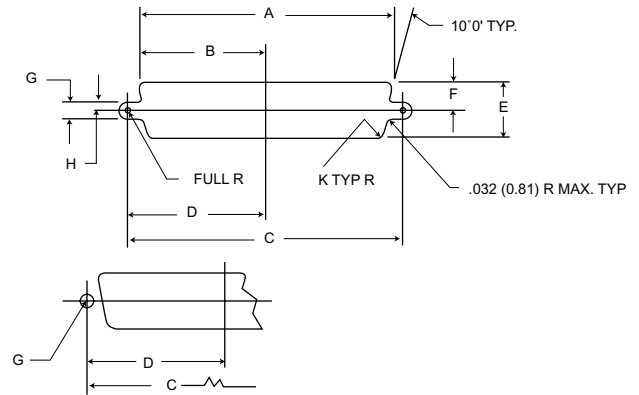

Conn.	Mtg. Method	A ± .005 (0.13)	B ± .005 (0.13)	C ± .005 (0.13)	D ± .005 (0.13)	E ± .005 (0.13)	F ± .005 (0.13)	G ± .002 (0.05)	H ± .002 (0.05)	K ± .002 (0.05)
2DE	Front	.874 (22.20)	.437 (11.10)	.984 (24.99)	.492 (12.50)	.513 (13.03)	.257 (6.53)	.120 (3.05)	.060 (1.52)	.083 (2.11)
	Rear	.806 (20.47)	.403 (10.24)	.984 (24.99)	.492 (12.50)	.449 (11.40)	.225 (5.71)	.120 (3.05)	.060 (1.52)	.132 (3.35)
2DA	Front	1.202 (30.53)	.601 (15.26)	1.312 (33.32)	.656 (16.66)	.513 (13.03)	.257 (6.53)	.120 (3.05)	.060 (1.52)	.083 (2.11)
	Rear	1.134 (28.80)	.567 (14.40)	1.312 (33.32)	.656 (16.66)	.449 (11.40)	.225 (5.71)	.120 (3.05)	.060 (1.52)	.132 (3.35)
2DB	Front	1.743 (44.27)	.872 (22.15)	1.852 (47.04)	.926 (23.52)	.513 (13.03)	.257 (6.53)	.120 (3.05)	.060 (1.52)	.083 (2.11)
	Rear	1.674 (42.52)	.837 (21.26)	1.852 (47.04)	.926 (23.52)	.449 (11.40)	.225 (5.71)	.120 (3.05)	.060 (1.52)	.132 (3.35)
2DC	Front	2.391 (60.73)	1.196 (30.38)	2.500 (63.50)	1.250 (31.75)	.513 (13.03)	.257 (6.53)	.120 (3.05)	.060 (1.52)	.083 (2.11)
	Rear	2.326 (59.08)	1.163 (29.54)	2.500 (63.50)	1.250 (31.75)	.449 (11.40)	.225 (5.71)	.120 (3.05)	.060 (1.52)	.132 (3.35)
2DD	Front	2.297 (58.34)	1.149 (29.18)	2.406 (61.11)	1.203 (30.56)	.623 (15.82)	.312 (7.92)	.120 (3.05)	.060 (1.52)	.083 (2.11)
	Rear	2.218 (56.34)	1.109 (28.17)	2.406 (61.11)	1.203 (30.56)	.555 (14.10)	.278 (7.06)	.120 (3.05)	.060 (1.52)	.132 (3.35)

For contact part numbers, termination tooling and assembly see pages 288-290.

Panel Mounting

→ 3/32 THICKNESS (REF.)
RECOMMENDED

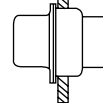

Front Mounting
Standard

→ RIVET THICKNESS

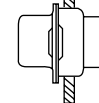

Front Mounting
Float

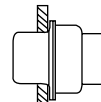

Rear Mounting
Standard

→ RIVET THICKNESS

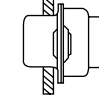

Rear Mounting
Float

Environmentally sealed Double Density D connector offers superior vibration and moisture resistant characteristics.

The connector features superior environmental sealing which makes it suitable for any application where severe environmental protection is critical.

The connector's contact density design was achieved by using field proven, highly reliable Centipin/Centisocket contacts on .075" centers.

Designed to maximize positive contact mating, the contact positions are reversed, leaving the flexible Centipin contacts recessed in the insulator while the more ruggedized centisocket contacts are exposed.

This reversal of positions and the chamfered-entry of the sockets assures positive mating even under severe conditions where misalignment or mismatching of the connector might occur.

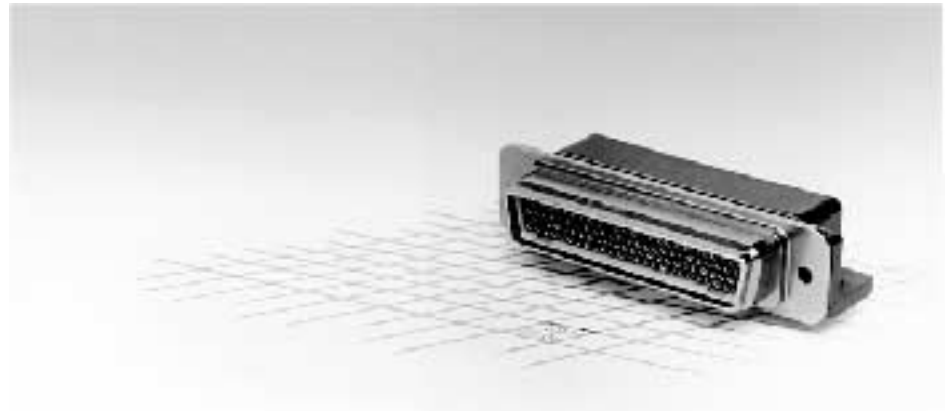

High reliability and protection of the contacts is assured through superior environmental sealing. The socket contacts as well as the Centipin contacts, which feature ITT Cannon's reliable Twist Pin contact design, are retained in the connector body.

A rubber grommet seal the signal wires and connector from external contaminants and moisture. The 90° PCB mounting 2D*D is potted behind the grommet for additional sealing.

How to Order

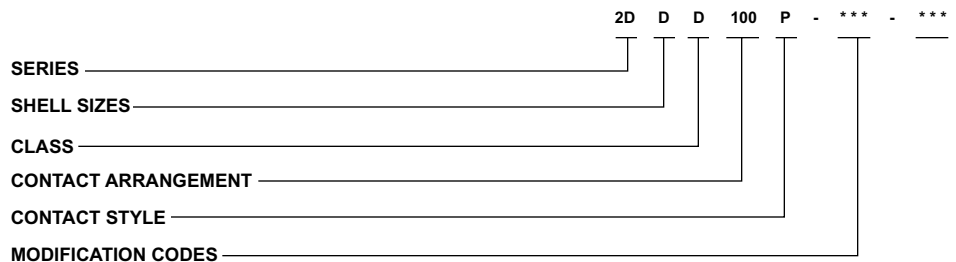

- SERIES:**
2D-Double Density "D"
- SHELL SIZES:**
D*
Consult factory for size E, A, B, C
- CLASS:**
D - Environmental

- CONTACT ARRANGEMENT**
100*
Consult factory for sizes 19, 31, 52, 79
- CONTACT STYLE**
P - Centi-Loc pin (receptacle shell config.)
S - Centi-Lock socket (plug shell config.)

- MODIFICATION CODES**
*** (Two 3-digit codes permissible)
F0 - Connector without contacts
(F0 will not be printed on the connector)
6 - Environmental D 90° PCB mounting
(socket configuration only)

* ITT Cannon is currently tooled in size D 100 contact version only.

Standard Data

Contacts:
Insertable/removalbe gold-plated size 22 centi-loc crimp contacts (wire sizes #22 thru #26 AWG, stranded or solid).

MATERIALS AND FINISHES

Housings	Aluminum alloy, yellow chromate over cadmium plate
Peripheral Seal	Silicone
Insulators	Diallyl Phthalate
Contacts Retainer	Nylon
Grommet	Polychloroprene (bonded to housing)

Contact Arrangement

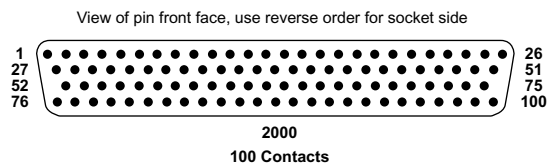

90° PCB Mounting

Plug/Socket Connector

2DDD100S-6

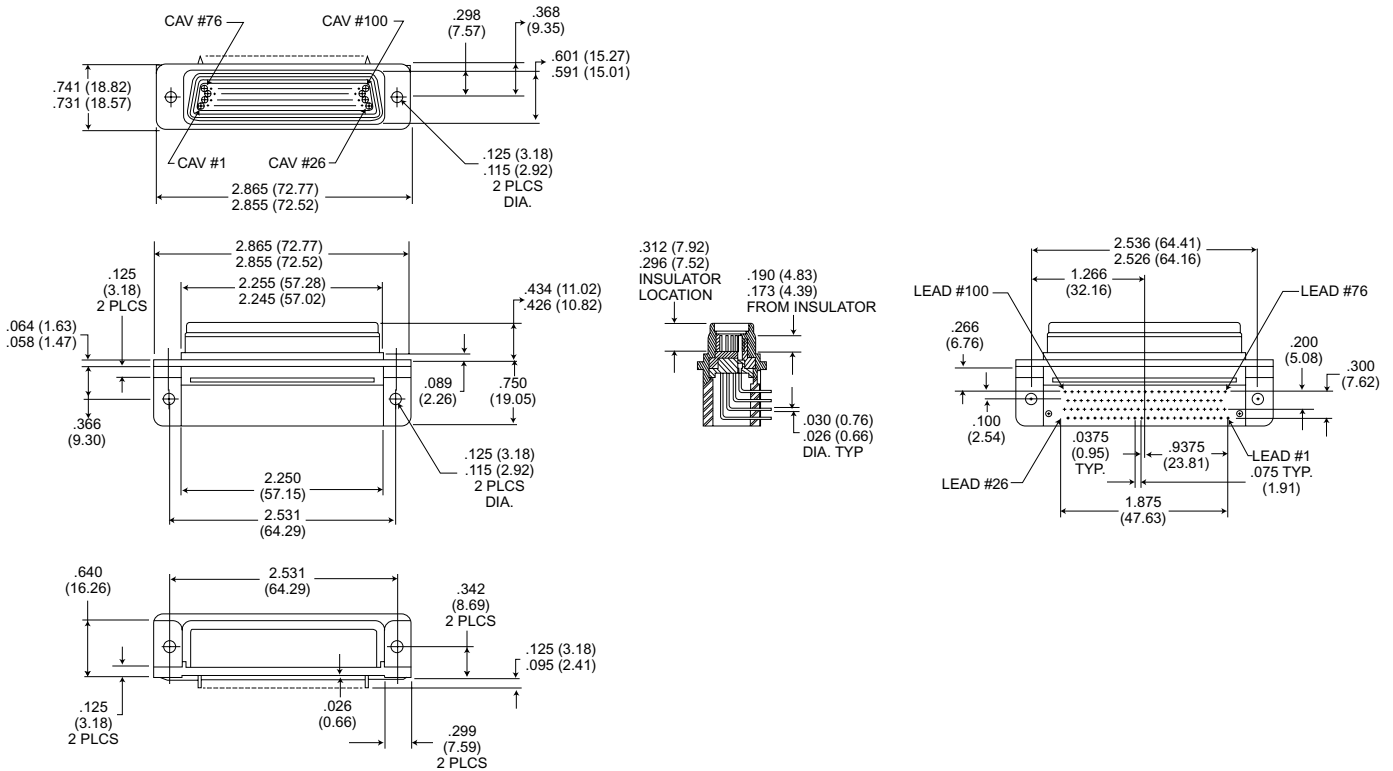

All tolerance are $\pm .010$ (0.25) unless otherwise noted.

Standard Mount

Receptacle/Pin Connector

2DDD100P

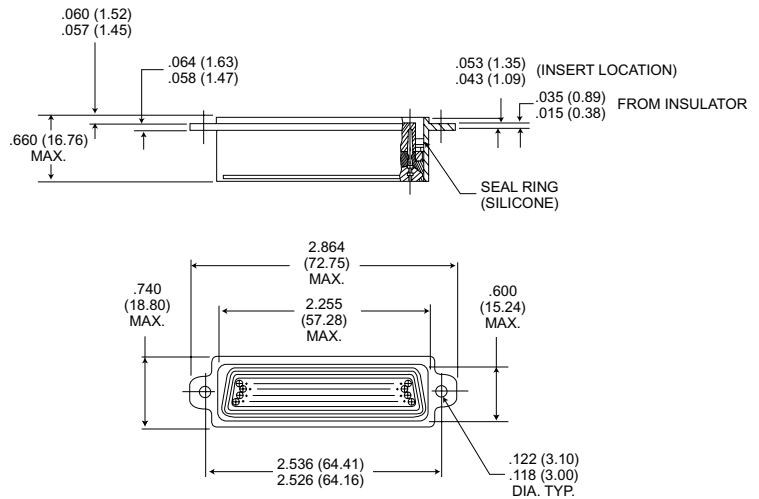

All tolerance are $\pm .010$ (0.25) unless otherwise noted.

Standard Mount (Continued)

Plug/Socket Connector

2DDD100S

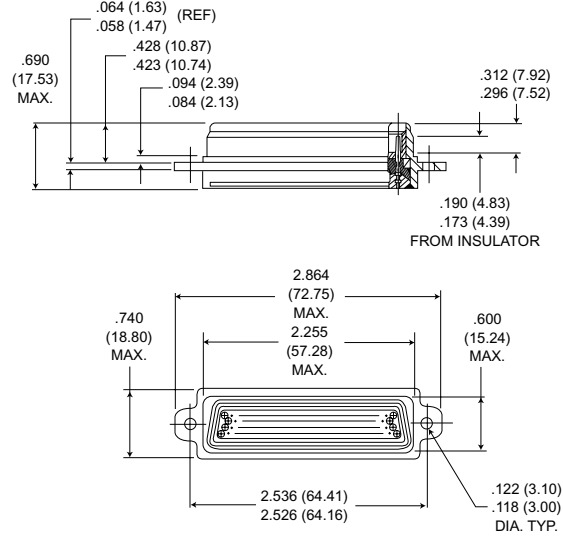

All tolerances are $\pm .010$ (0.25) unless noted otherwise.

Panel Cutout

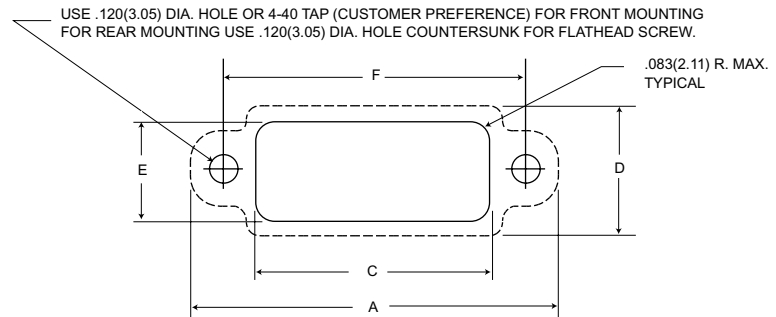

Shell Size	A $\pm .010$ (0.25)	C Min.	D $\pm .010$ (0.25)	E Min.	F $\pm .006$ (0.15)
2DDD-100	2.859 (72.62)	2.265 (57.53)	.735 (18.67)	.610 (15.49)	2.531 (64.29)

Note: Panel cutout does not allow for potting cup clearance.

Mounting Dimensions

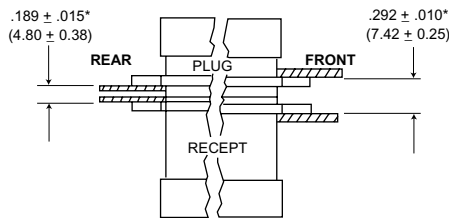

Figure 1 Figure 2

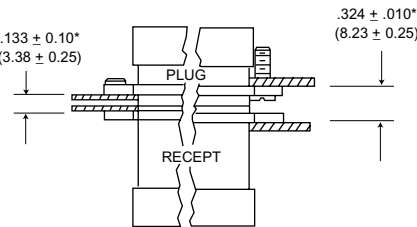

Figure 3 Figure 4

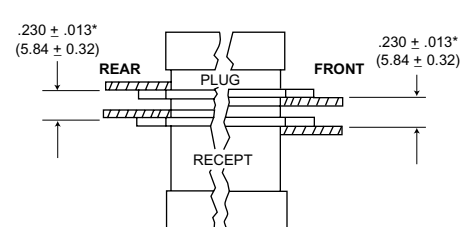

Figure 5 Figure 6

- With both connectors rear mounted, use #4-40 flat head screws flush with the panel.
- With both connectors front mounted, use #4-40 binder or pan head screws.
- With both connectors rear mounted (float mounting on either plug or receptacle side), use #4-40 flat head screws, flush with the panels.
- With both connectors front mounted (float mounting on either plug or receptacle side), use #4-40 binder or pan head screws.
- With plug assembly front mounted and receptacle assembly rear mounted, use hardware from Figures 5 and 6. If float mounting is desired, use Figure 3 or 4 for the float mounted connector.

*Dimensions between panels represent the recommended limit to be used in the design of the connector mounting method.

NOTE: Max. panel thickness is .125 (3.17) for non-floating rear panel mounting.



A subminiature all plastic high density "D" rectangular connector. The CDL is a general purpose connector with a peripheral o-ring and wire sealing gasket. Connector utilizes rear insertion, front release, crimp snap-in size 22, centi-loc contacts installable by the customer or, if preferred, by the factory.

MATERIAL

Insulator:	Black Nylon
Dielectric Gasket:	Polychloroprene
Contact:	Copper Alloy, Gold Plated
Seal Ring:	Silicone

How to Order

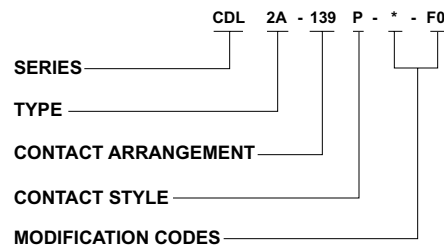

SERIES

Centi-D Loc Series

TYPE

- 1 - Snap
- 2 - No lock (mtg. holes)
- 3 - Ring lock
- 2A - No lock type with rear gasket

CONTACT ARRANGEMENT

139
(Consult factory for other sizes)

CONTACT STYLE

- P - Centi-loc pin
- S - Centi-loc socket

MODIFICATION CODES

- 1 - Less lock ring
- F0 - Less contacts

Plug

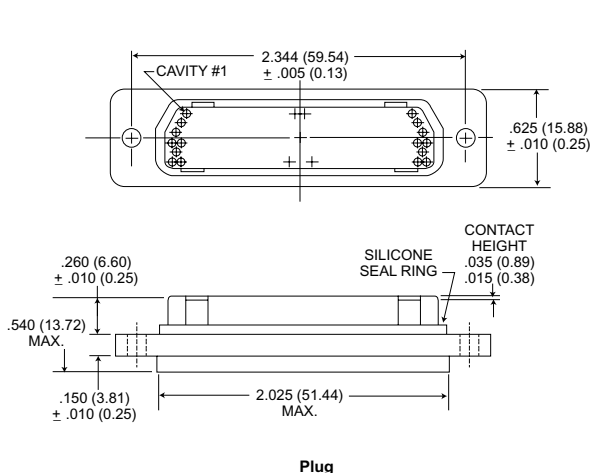

Plug

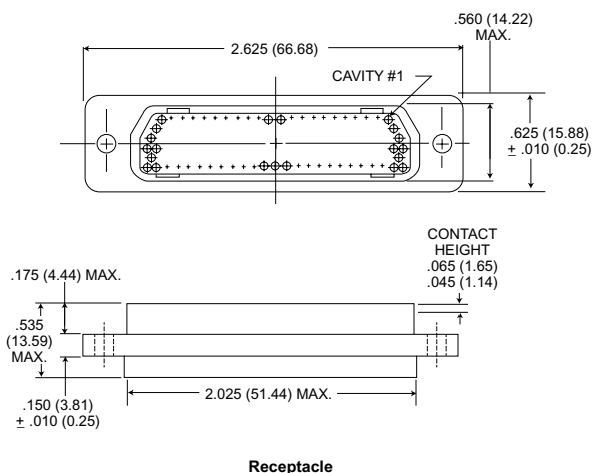

Receptacle

Recommended Panel Cutouts

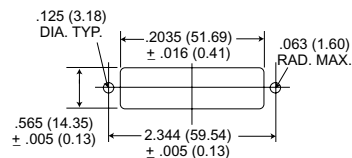

Contact Arrangements

Engaging Face View

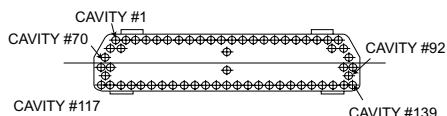

Plug

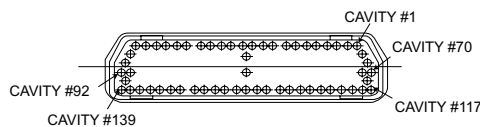

Receptacle

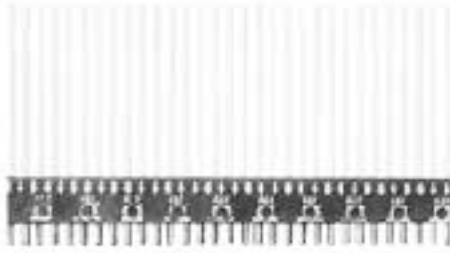

CENTI-LOC connectors are low-cost nylon strip connectors designed for commercial applications such as computers, instrumentation, communications, calculators and medical equipment. They are available in "yardage" from up to a 6 (152.40) maximum length, accommodatin from 1 to 60 rear insertion, front release, crimp snap-in size 22 CENTIPIN™/CENTISOCKET™ contacts. These contacts utilize a proven positive contact alignment design, giving additional contact strength and positive contact alignment during mating.

These connectors can be ordered in kit or bulk form. The kit comprises all the parts necessary to assemble on complete 6-inch (152.40) strip connector with 60 contacts on .100 (2.54) centers or a 4-inch (101.60mm) strip with 53 contacts on .075 (1.91) centers. If more than one connector is required, the parts can be ordered in bulk and assembled as desired.

Components and Accessories

The CENTI-LOC strip connector can be ordered in kit or bulk form. The kit includes mating insulators with a full compliment of contacts and two guide posts. If more than one connector is required, the parts can be ordered in bulk and assembled as desired.

Kit Form

Kits include mating insulators with full complement of contacts and two guide posts.

Part Number	Contact Center spacing
CTA3-KIT	.075 (1.91)
CTA4-KIT	.100 (2.54)
CTA3-CTA4-KIT	.075 (1.91) & .100 (2.54)

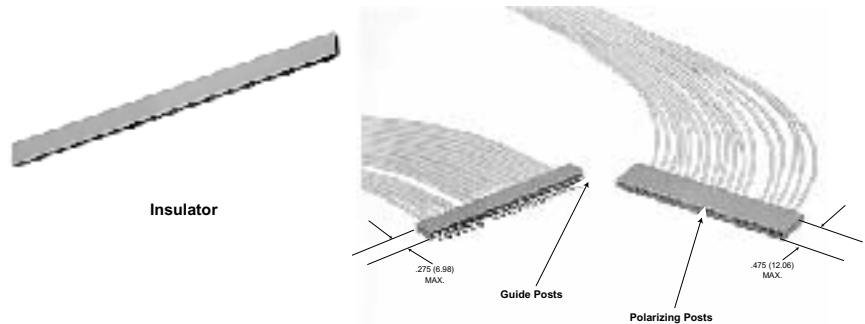

The guide posts and polarizing posts are inserted in the same manner as the contacts. The guide posts are inserted into the socket insulator and the polarizing posts are inserted into the pin insulator. The corresponding contact in the mating insulator must be removed for each. See assembly instructions.

	Part Number	Contact Center Spacing	Type	Material
Insulator	CTA3-IP-53	.075 (1.91)	Pin	Nylon
	CTA3-IS-53	.075 (1.91)	Socket	Nylon
	CTA4-IP-60	.100 (2.54)	Pin	Nylon
	CTA4-IS-60	.100 (2.54)	Socket	Nylon
Guide Post	CTA-GP	P/N 230-9507-000		Passivated Stainless Steel
Polarizing Post	CTA-PP	P/N 230-9506-000		Passivated Stainless Steel

Dimensional Data

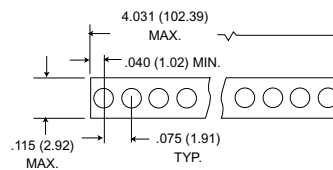

CTA3-.075(1.91) Centers

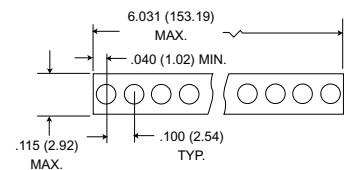

CTA4-.100(2.54) Centers

Weights

Part Number	No. of Contacts	Contacts Type	Avy. Weight oz.	± 5% gm.
CTA3	53	pin	.185	5.25
		socket	.203	5.75
CTA4	60	pin	.230	6.30
		socket	.241	6.90

Contacts



The contacts are retained in the insulator by means of a resilient internal shoulder that allows contact to snap into a locking groove.

The front of the contact is chamfered so that the internal shoulder in the insulator is not damaged as the contact is pushed thru.

P.C. Tail Contacts

Subtract .064 (1.63) ± .010 (.25) from pigtail length when used in 2D pin insulator for potting well of connector assembly.

Subtract .081 (2.08) ± .010 (.25) from pigtail length when used in 2D socket insulator for potting well of connector assembly.

Contact Part Number

Part Number		Type	Pin		Socket	
Pin	Socket		Pin	Socket		
031-9540-000	030-9542-001	Standard 30µin. plating				
031-9540-004	030-9542-002	50µ in. plating				
031-9540-005	030-9542-004	With inspection hole; 50µ in. plating				
N/A	030-9542-011	P.C. tail .026 dia. x .083 lg. Soc.				
*031-9540-013	030-9542-012	P.C. tail .183 lg. Soc. .020 dia. x .183 lg. Pin				
031-9540-016	030-9542-014	Long crimp barrel				
031-9540-022 ***	030-9556-000 ***	Small crimp bore For AWG #32 & 30				
031-9540-007	030-9542-022	Small crimp bore For AWG #28 & 30				
*031-9540-015	030-9542-015	P.C. tail .232 lg. Soc. .020 dia. x .255 lg. Pin				
*031-9540-019	030-9542-016	P.C. tail .444 lg. Soc. .018 dia. x .445 lg. Pin 50µ in. plating				

NOTE: Plating, except as noted, is 30 micro-inch gold.

* Consult factory for any tail size or plating requirements.

** Special crimp locator required. Part number: 995-0001-714. (L3198-CL-PSL)

*** Use special insertion tip (323-9510-016 &-017).

2D and Centi-Loc Crimp and Assembly Tools



M22520/2-01

Description	Tool	Locators	
		Pin	Socket
	M22520/2-01	L3198-CLP	L3198-CLS
Part Number	995-0001-584	995-0001-338	995-0001-353

Insertion Tools For Standard Contact

AWG Size*	Kit Part Number (handle and tip)	Tip Part Number**	Handle Part Number**
22	CIT-PS-CTA-22	323-9510-001	204-9500-000
24	CIT-PS-CTA-24	323-9510-002	204-9500-000
26	CIT-PS-CTA-26	323-9510-003	204-9500-000
28	CIT-PS-CTA-28	323-9510-004	204-9500-000
30/P.C. Tail	CIT-PS-CTA-30	323-9510-005	204-9500-000

* Based on wire size per MIL-W-16878 with Type E insulation, use smaller tool for wire with thin insulation, larger tool for wire having thick insulation.

** The 5 insertion tips (part numbers 323-9510-001 thru -005), plus handle, and the pin and socket extraction tips maybe ordered as a SINGLE KIT by specifying the part number CIET-CTA-2. [Part number: 070143-0002].

Insertion Tools For Long Crimp barrel Contacts

AWG Size*	Tip Part Number *** Pin Contact	Tip Part Number *** Socket Contact	Handle Part Number***
22	323-9510-008	323-9510-012	204-9500-000
24	323-9510-009	323-9510-013	204-9500-000
26	323-9510-010	323-9510-014	204-9500-000

*** To order the SINGLE KIT for the long crimp barrel contact (tip part numbers 323-9510-008 thru -014, handle and pin and socket extraction tips) please specify CIET-CTA-3.



CIET-CTA Handle

Insertion Tips



CTA-AB Assembly Holding Block
Part Number: 328-9508-000

Extraction Tools

Contact	Description	Kit Part Number (handle and tip)	Tip Part Number	Handle Part Number
CENTIPIN	CET-P-CTA-2	070112-0002	324-9502-000	204-9500-000
CENTISOCKET	CET-S-CTA-1	070113-0001	324-9501-000	204-9500-000

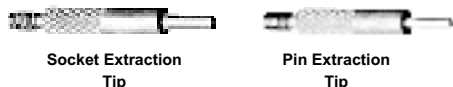

Socket Extraction Tip

Pin Extraction Tip

2D/CTA CENTI-LOC™ Connectors Assembly Instructions

The Double Density D/CTA CENTI-LOC Connectors are highly reliable and simple connectors to use. There are a few helpful suggestions that will assure complete satisfaction when followed:

1. The following instructions should be followed.
2. The proper crimp tool and locator (if required) must be used. These tools have been designed for use with this product. Substitutions of crimping equipment may result in connector failure at the assembly operation.
3. After crimping a contact to a lead it is of vital importance that the proper tool be used to assure seating the contact in the insulator in the proper position. Any substitution of insertion tools may result in over or under insertion of the contact which will damage the retention system of the insulator.

4. The female (socket) side of the connector has been designed with a controlled float to allow for ease of mating. To avoid reducing this float or causing a splaying of the contacts, any unnecessary strain by clamping too close to the rear of the connector should be avoided.

Use of recommended tooling together with proper assembly techniques will pay dividends in reliability and reduced costs.

2D Assembly Instructions

WIRE STRIPPING

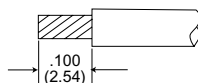

Cut the wires to length required and strip .100" of insulation from the end to be crimped. Check for cut or broken wires and frayed insulation.

CONTACT CRIMPING



Using the proper crimp tool and locator, insert the contact into the locator. Insert the stripped end of the wire into the contact crimp pot, and crimp the contact to the wire. Squeeze the handles firmly to insure a proper crimp (tool will not release if crimping is incomplete). NOTE: Contact stop must be changed in tool locator when crimping pin and socket contacts.

CONTACT INSERTION



1. Place the proper insertion tip in the insertion/-extraction handle and put the tip over the wire as shown. The tool tip will butt up against the crimp pot. Connector must be firmly supported during both insertion and extraction operations.



2. Using a firm, steady pressure, push the contact into the cavity until the resilient internal shoulder in the insulator snaps into the locking groove in the contact. The shoulder of the tool tip bottoms against the rear of the insulator, preventing over-insertion. Repeat for balance of contacts.

CONTACT EXTRACTION



1. For contact extraction, remove the insertion tool tip and replace it with the proper extraction tool tip. (The socket tip will fit into the socket, and the pin tip will slide over the pin bundle). Insert the tool tip into the contact cavity: (the pin tip will butt up against the shoulder of the pin contact, and the socket tip will bottom in the socket contact.)



2. Apply a firm, steady pressure until the contact is released from the internal shoulder in the insulator. The shoulder of the tool tip bottoms against the insulator face to prevent damage to the internal shoulder. Remove the tool tip and pull the contact from the rear of the connector. Repeat for the balance of contacts to be removed.

CTA Assembly Instructions

INSERTION



1. Place the connector into the slot in the assembly block with the arrows on the insulator pointing downward. The connector will bottom against the internal shoulder in the groove in the assembly block. Start contact insertion by placing the crimped contact in the cavity by hand.



2. Position the insertion tool tip on the rear of contact as shown. The insulation must be pulled back from the crimp pot approximately 1/32" to allow the tool tip to butt against the contact crimp pot.



3. With firm steady pressure, push the contact into the cavity until the resilient internal shoulder snaps into the locking groove in the contact. To prevent over insertion, the tool tip bottoms against the rear of the insulator.

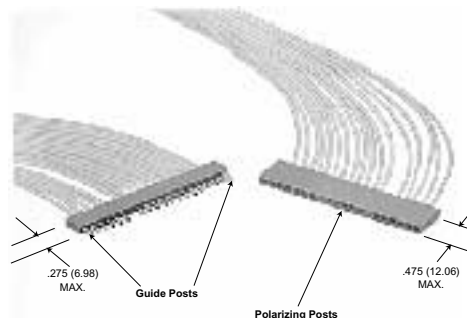

4. The guide post and polarizing posts are inserted in the same manner as the contacts. The guide posts are inserted into the socket insulator, and the polarizing posts are inserted into the pin insulator. The corresponding contact in the mating insulator must be removed for each.

EXTRACTION



1. To extract the contacts, place the connector face up in the assembly block so that the contact to be extracted is in the end of the block that has a fully slotted opening.



2. The pin extraction tool tip is tubular, slides over the pin bundle and butts against the front shoulder of the pin. The socket extraction tool is a solid rod that fits into the socket contact, the external shoulder butts against the contact socket shoulder.



3. Insert the extraction tool into the cavity and apply firm pressure until the contact is pushed thru the rear of the connector.

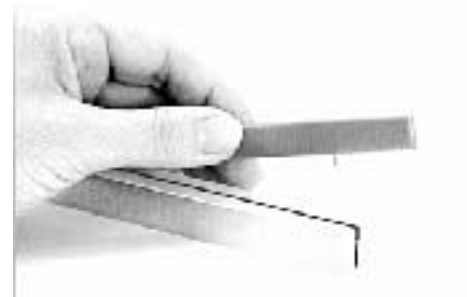

4. Lift the insulator from the groove and pull the contact out. Repeat for balance of contacts to be removed.

The NANO Line - .025" Contact Spacing



NANO contacts incorporate the highly reliable Twist Pin concept, which allows continuity in very dense areas and under severe shock and vibration, requiring low engagement and separation forces. Termination can consist of uninsulated pigtailed or insulated wire all pre-harnessed at our factory to your specifications.

Due to various industry application requirements, the NANO line is available in several different

configurations: strip, metal shell and plastic, rectangular or circular configurations with center jack-screw, a 72 position circular connector with center-jackscrew, metal shell with combination layout, or discrete board-to-board stacking contact.

Successful applications for NANO connectors are many and varied, from the Air Force's AIRS program to actual human implantations in the medical research field.

Performance and Material Specifications

- Contact Rating - 1 amp max.
- Minimum contact centers - 0.025 (0.64).
- Wire sizes - #32 AWG stranded, #30 AWG solid.
- Contact termination - integral pigtails or multiple indent crimp.
- Contact retention - fixed via epoxy.
- Contact materials - socket: nickel silver.
pin bundle: precious metal alloy or BeCu.
pin Sleeve: nickel silver or cartridge brass.
- Mating/unmating force - 6oz. per contact max.

	NTP	NDM	NJS	NTDP	NJSC
Type	Single Row Strip	Metal Shell Rectangular	Rectangular Center Jackscrew	Dual Row Strip	Circular Center Jackscrew
Shell		Alum. alloy 2024 T351 per QQ-A-250 or 6061-T6 per QQ-A-200 nickel plate			
Insulator	Phenolic	Phenolic	Polyester	Phenolic	Polyester
No. of Contacts	1-40 Contacts	9, 15, 21, 25, 31, 37	9, 24, 44	90	27, 72, 266
Pin Bundle Material	- Precious metal per ASTM B477 and ASTM B541, or BeCu per CDA alloy 172 & 102 -				
Socket Sleeve Material	- Nickel silver/ASTM B122, Comp. B-				
Pin Sleeve Material	- Nickel silver per ASTM B122, Comp. B or Cartridge Brass per CDA alloy 260 -				

Test Data

The table below summarizes the results of key tests performed in accordance with MIL-STD-202, where applicable. Data is applicable to standard configurations with standard terminations. Variations may affect this data, so please consult the factory for further information on your requirements.

Test	Method	Criteria of Acceptance
Dielectric Withstanding Voltage	Method 301: 350 VAC at sea level 100 VAC at 70,000' altitude	No breakdown No breakdown
Insulation Resistance	Method 302 Condition A	5,000 megohms minimum
Thermal Shock	Method 107, Condition B: -65°C to +125°C	No physical damage
Physical Shock	Method 213, Condition I: 100 G's, 3-axes, 6 millisecond duration sawtooth pulse	No physical damage No loss of continuity > 1 μ sec
Vibration	Method 204, Condition D: 15 G's, 10-2,000 Hz, 12 hours	No physical damage No loss of continuity > 1 μ sec
Durability	500 cycles of mating and unmating, 500 CPH max.	No mechanical or electrical defect
Moisture Resistance	Method 106, omit 7B	Insulation resistance > 100 megohms
Salt Spray	Method 101. Condition B: 48 hours	Shall be capable of mating and unmating, and meet contact resistance requirements
Contact Resistance	Method 307: At 1 amp At 100 milliamps	30 milliohms maximum } With gold plated Be-Cu Nanopin contact. 60 milliohms maximum } With precious metal alloy Nanopin contact. 80 milliohms maximum }
Contact Retention	-	3 lb. minimum axial load

How to Order - NT

NT P 2 40 S H ***

SERIES _____

INSULATOR MATERIAL _____

CONTACT LOCATION _____

CONTACT ARRANGEMENTS _____

CONTACT TYPE _____

TERMINATION TYPE _____

MODIFICATION CODE _____

SERIES
Nano Strip

INSULATOR MATERIAL
P - Phenolic

CONTACT LOCATION
1 - Contacts on .025 (0.64) centers
2 - Contacts on .050 (1.27) centers

CONTACT ARRANGEMENTS
40 Maximum - .025 (0.64) centers
20 Maximum - .050 (1.27) centers

CONTACT TYPE
P - Pin (Plug)
S - Socket (Receptacle)

TERMINATION MODIFICATION
L - Solid uninsulated wire
T - One piece contact/lead
H - Insulated harness wire

MODIFICATION CODE
For termination code, see NJS section, page 294.

Dimensions

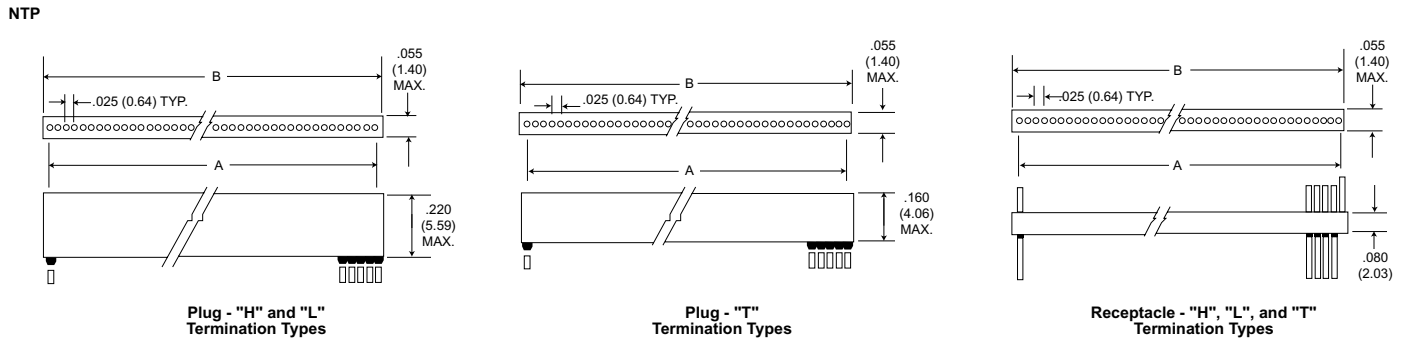

Part Number by Insulator Size	A Ref.	B ±.010 (0.25)	Part Number by Insulator Size	A Ref.	B ±.010 (0.25)	Part Number by Insulator Size	A Ref.	B ±.010 (0.25)	Part Number by Insulator Size	A Ref.	B ±.010 (0.25)
NTPI-1*-**	-	.050 (1.27)	NTPI-11*-**	.250 (6.35)	.300 (7.62)	NTPI-21*-**	.500 (12.70)	.550 (13.97)	NTPI-31*-**	.750 (19.05)	.800 (20.32)
NTPI-2*-**	.025 (0.64)	.075 (1.91)	NTPI-12*-**	.275 (6.99)	.325 (8.26)	NTPI-22*-**	.525 (13.34)	.575 (14.61)	NTPI-32*-**	.775 (19.69)	.825 (20.96)
NTPI-3*-**	.050 (1.27)	.100 (2.54)	NTPI-13*-**	.300 (7.62)	.350 (8.89)	NTPI-23*-**	.550 (13.97)	.600 (15.24)	NTPI-33*-**	.800 (20.32)	.850 (21.59)
NTPI-4*-**	.075 (1.91)	.125 (3.18)	NTPI-14*-**	.325 (8.26)	.375 (9.53)	NTPI-24*-**	.575 (14.61)	.625 (15.88)	NTPI-34*-**	.825 (20.96)	.875 (22.23)
NTPI-5*-**	.100 (2.54)	.150 (3.81)	NTPI-15*-**	.350 (8.89)	.400 (10.16)	NTPI-25*-**	.600 (15.24)	.650 (16.51)	NTPI-35*-**	.850 (21.59)	.900 (22.86)
NTPI-6*-**	.125 (3.18)	.175 (4.45)	NTPI-16*-**	.375 (9.53)	.425 (10.80)	NTPI-26*-**	.625 (15.88)	.675 (17.15)	NTPI-36*-**	.875 (22.23)	.925 (23.50)
NTPI-7*-**	.150 (3.81)	.200 (5.08)	NTPI-17*-**	.400 (10.16)	.450 (11.43)	NTPI-27*-**	.650 (16.51)	.700 (17.78)	NTPI-37*-**	.900 (22.86)	.950 (24.13)
NTPI-8*-**	.175 (4.45)	.225 (5.72)	NTPI-18*-**	.425 (10.80)	.475 (12.07)	NTPI-28*-**	.675 (17.15)	.725 (18.42)	NTPI-38*-**	.925 (23.50)	.975 (24.77)
NTPI-9*-**	.200 (5.08)	.250 (6.35)	NTPI-19*-**	.450 (11.43)	.500 (12.70)	NTPI-29*-**	.700 (17.78)	.750 (19.05)	NTPI-39*-**	.950 (24.13)	1.000 (25.40)
NTPI-10*-**	.225 (5.72)	.275 (6.99)	NTPI-20*-**	.475 (12.07)	.525 (13.34)	NTPI-30*-**	.725 (18.42)	.775 (19.69)	NTPI-40*-**	.975 (24.77)	1.025 (26.04)

NTDP3-90-ST*

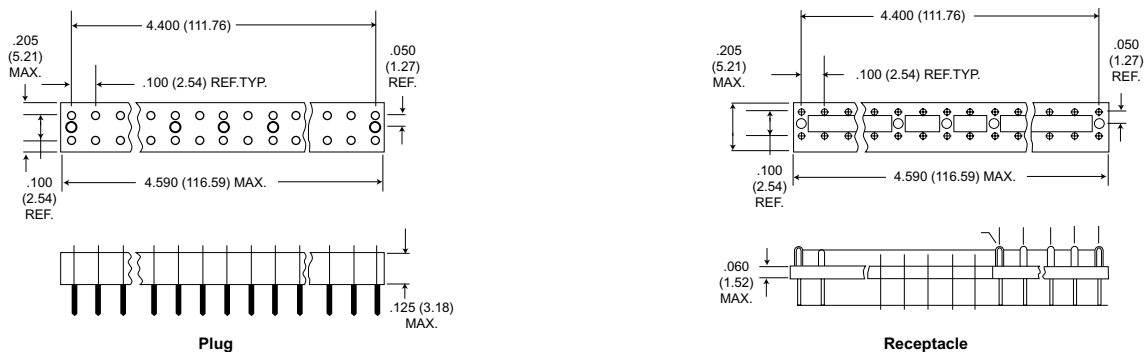

How to Order - NDM



SERIES
 NDM - NANO D Metal Shell

CONTACT ARRANGEMENTS
 9, 15, 21, 25, 31, 37

CONTACT TYPE
 P = Pin (Plug)
 S = Socket (Receptacle)

TERMINATION TYPE
 H = Insulated harness wire
 L = Solid copper
 T = One piece contact/lead

MODIFICATION CODE
 To specify lead lengths, type and mechanical modifications consult factory.

Dimensions

NDM

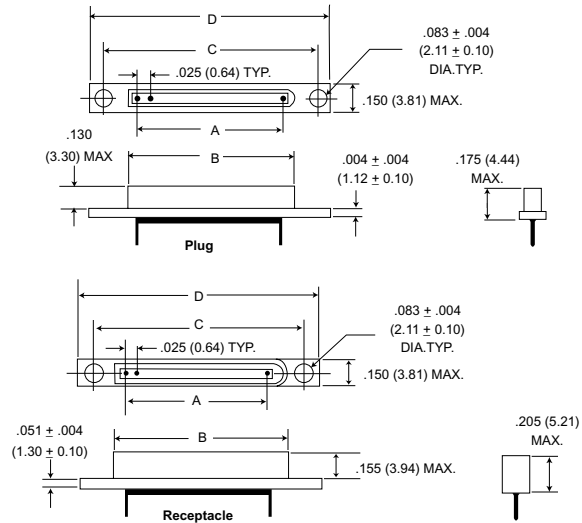

Part Number By Shell Size	A Ref.	Plug B Ref.	Receptacle B Ref.	C ±.005 (0.13)	D Max.
NDM-15P*/S*	.350 (8.89)	.467 (11.86)	.530 (13.46)	.715 (18.16)	.875 (22.23)
NDM-21P*/S*	.500 (12.7)	.617 (15.67)	.680 (17.27)	.865 (21.97)	1.025 (26.04)
NDM-25P*/S8	.600 (15.24)	.717 (18.21)	.780 (19.81)	.965 (24.51)	1.125 (28.58)
NDM-31P*/S*	.750 (19.05)	.867 (22.02)	.930 (23.62)	1.115 (28.32)	1.275 (32.39)
NDM-37P*/S*	.900 (22.86)	1.017 (25.83)	1.080 (27.43)	1.265 (32.13)	1.425 (36.20)

Consult factory for availability of other sizes.

Panel Mounting Dimensions

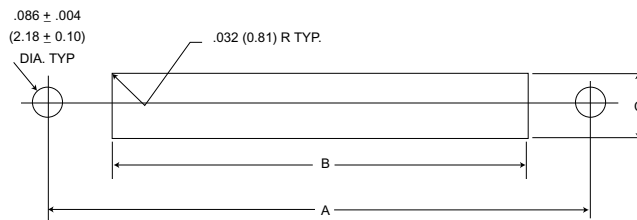

Size	A	B	C
	±.005 (0.13)	+.005 (0.13) -.000 (0.00)	+.005 (0.13) -.000 (0.00)
9	.565 (14.35)	.261 (6.63)	.095 (2.41)
15	.715 (18.16)	.411 (10.44)	.095 (2.41)
21	.865 (21.97)	.561 (14.25)	.095 (2.41)
25	.965 (24.51)	.661 (16.79)	.095 (2.41)
31	1.115 (28.32)	.811 (20.60)	.095 (2.41)
37	1.265 (32.13)	.961 (24.41)	.095 (2.41)

How to Order - NJS



SERIES

- NJS - Nano center jackscrew rectangular (9, 24, 44)
- NJSC - Nano center jackscrew circular (27, 72, 266)

CONTACT ARRANGEMENTS

- 9, 24, 27, 44, 72, 266

CONTACT TYPE

- P = Pin (Plug)
- S = Socket (Receptacle)

TERMINATION TYPE

- H = Insulated harness wire
- L = Solid uninsulated wire
- T = One piece contact/Lead

TERMINATION CODE*

- (H) 001 = 18" #32 AWG 7/40 strd. Type "ET" Teflon per MIL-W-16878/6, color yellow.
- (H) 003 = 18" #32 AWG 7/40 strd. Type "ET" Teflon per MIL-W-16878/6 color coded to MIL-STD-681, System 1.
- (L) 1 = 1/2" uninsulated solid #30 AWG gold plated copper.
- (L) 2 = 1" uninsulated solid #30 AWG gold plated copper
- (T)* = Consult factory

* See Termination Codes shown below for additional length modification codes.

Standard Wire Termination Codes

The following termination codes are listed for your information. For lengths not shown, consult factory for proper modification code. All wire lengths are minimum.

Harness Type (H)

#32 AWG, 7/40 stranded, Type "ET" per MIL-W-16878/6

Length	All Yellow	Color Coded
3 (76.2)	H 020	H 027
6 (152.4)	H 019	H 016
8 (203.2)	H 026	H 034
10 (254.0)	H 029	H 025
12 (304.8)	H 028	H 002
18 (457.2)	H 001	H 003
20 (508.0)	H 038	H 023

Solid Uninsulated Type (L)

#32 AWG gold plated copper.

Length	All Yellow	Color Coded	Code	Length	Code	Length
24 (609.6)	H 009	H 004	L61	.125 (3.18)	L14	.750 (19.05)
30 (762.0)	H 010	H 005	L56	.150 (3.81)	L2	1.000 (25.40)
36 (914.4)	H 011	H 006	L57	.190 (4.83)	L7	1.500 (38.10)
48 (1219.2)	H 013	H 048	L39	.250 (6.35)	L6	2.000 (50.80)
72 (1828.8)	H 017	H 046	L58	.375 (9.53)	L16	2.500 (63.50)
120 (3048.0)	H 042	H 041	L1	.500 (12.70)	L10	3.000 (76.20)

Center Jackscrew/Rectangular

NJS-9 & NJS-24

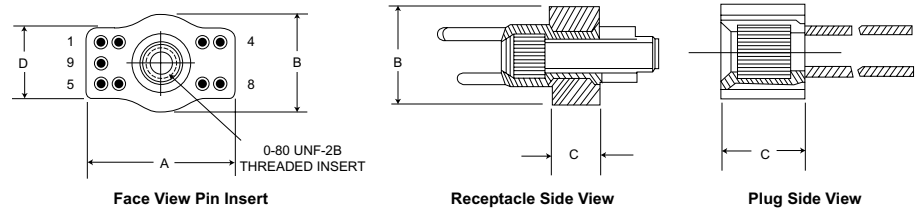

Part Number	A Max.	B Max.	C ± 0.005 (0.13)	D ± 0.005 (0.13)
NJS-9P*	.255 (6.48)	.165 (4.19)	.138 (3.51)	.116 (2.95)
NJS-9S*	.255 (6.48)	.165 (4.19)	.078 (1.98)	.116 (2.95)
NJS-24P*	.435 (11.05)	.165 (4.19)	.138 (3.51)	.116 (2.95)
NJS-24S*	.435 (11.05)	.165 (4.19)	.078 (1.98)	.116 (2.95)

Center Jackscrew/Rectangular

NJS-44P

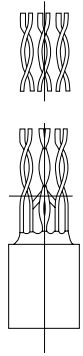
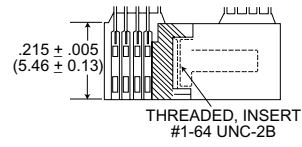
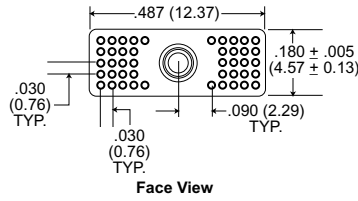

NJS-44S

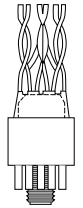
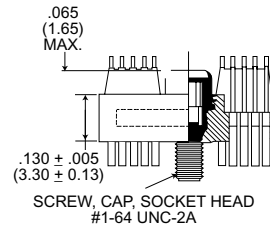
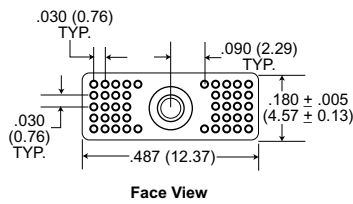

Contacts

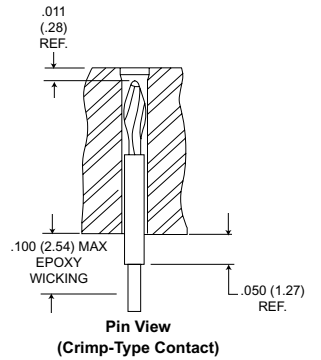
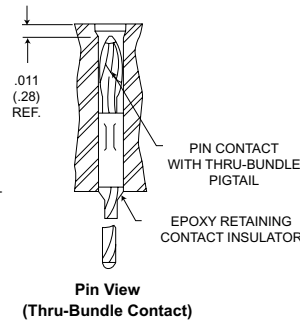
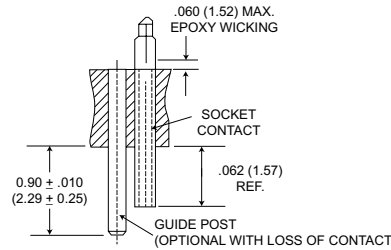

NOTE: Guide posts can be installed in any contact cavity for polarization purposes.

Connector Saver

NJS-9P & S

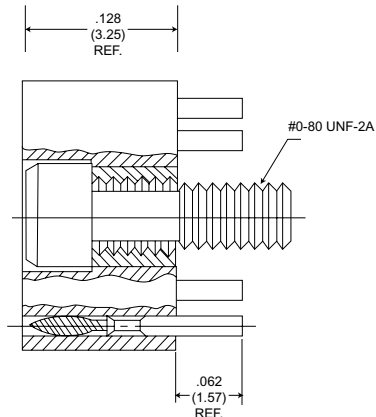
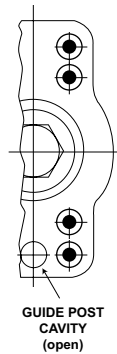

ITT Cannon fiber optic contacts...a standard in the industry. We offer the most complete line of fiber optic contacts, engineered to fit today's MIL-Spec circular, rack and panel, edgecard/LRM, and D Subminiature connectors.











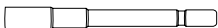

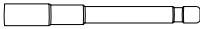
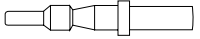

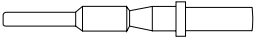
- Conforms to MIL-T-29504 fiber optic termini.
- Fits any size 16 cavity with no modification to connector.

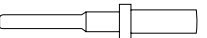
- Designed for use with standard size 16 contact insertion/extraction tool.
- Both pin and socket contact end faces are easily cleaned.

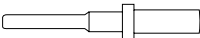
Fiber Optic Contact Performance Data

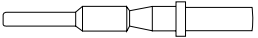
Durability	< 0.5 dB change after 500 matings
Temperature Shock	< 0.5 dB change during and after test
Operating Temperature	- 65°C to + 200°C (Cable/contact dependent)
Vibration, random (16 hrs/MIL-C-38999)	< 0.5 dB change during and after test
Optical Loss Performance	Typical 1.0 dB using 100/140 micron fiber-tested per EIA FOTP-34, Method A

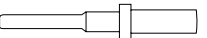
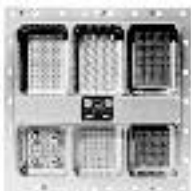
Standard MIL-Spec Connector

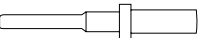
Standard Connector	Cannon Designator	Number of Size #16 Cavities Available Dependent Upon Shell Size	Fiber Optic Contact	
			Socket (Body)	Pin (Body)
 MIL-C-38999 Series I	KJL	1-29	 MIL-T-29504/5	 MIL-T-29504/4
 MIL-C-38999 Series III MIL-C-38999 Series IV	KJA	1-29	 MIL-T-29504/11	 MIL-T-29504/10
 MIL-C-26482 Series I	KPSE	1-31	 MIL-T-29504/9	 MIL-T-29504/8
 MIL-C-26482 Series II MIL-C-83723 Series I MIL-C-83723 Series III	PV7 PVA HTMF	1-31 1-31 1-52	 MIL-T-29504/7	 MIL-T-29504/6
 MIL-C-83733	DPK	Up to 64	 MIL-T-29504/11	 MIL-T-29504/10
 MIL-C-28840	KFS	Up to 8	 MIL-T-29504/9	 MIL-T-29504/8
 ARINC 600	BKAD	Up to 6	 MIL-T-29504/7	 MIL-T-29504/6
 MIL-C-83527	BKW	Up to 30	 MIL-T-29504/7	 MIL-T-29504/6

Ceramic Tip Optical Contacts

ITT Cannon's new precision optical contacts offer superior coupling performance and a simplified termination process. Ceramic zirconia tips more accurately center the fiber within the contact body. A rugged thermoplastic alignment sleeve precisely aligns the mating contacts. Solid state epoxy retained within the contact eliminates any handling of epoxy

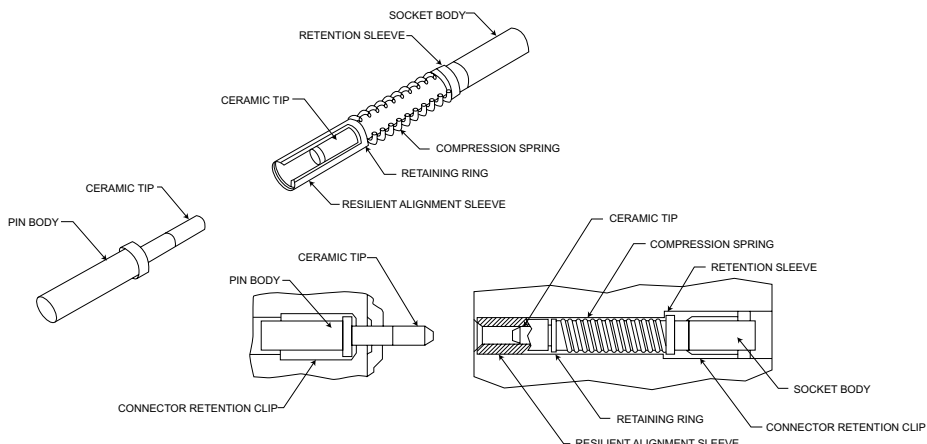

How to Order Fiber Optic Hybrid Contacts

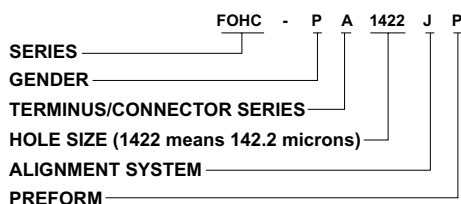

SERIES - Fiber Optic Hybrid Contacts

GENDER

P - Pin

S - Socket

TERMINUS/CONNECTOR SERIES

- A - MIL-C-29504/4 & /5: For use in MIL-C-38999 Series I, III & IV Connectors.
- B - MIL-T-29504/10 & /11: For use in MIL-C-83723 Series I, III; MIL-C-83733; and MIL-C-26482 Series II Connectors.
- C - MIL-C-29504/6 & 7; For use in MIL-C-83527; MIL-C-81659; ARINC 600; and ARINC 404 Connectors.
- D - (No Terminus Spec): For use in MIL-C-26482 Series I & MIL-C-26500 Connectors.
- E - (No Terminus Spec): For use in MIL-C-83723 Series II & MIL-C-5015G Connectors.
- F - MIL-C-29504/8 & /9: For use in MIL-C-28840 Connectors.
- G - (No Terminus Spec): For use in MIL-C-83723 Series III/82, /83, /86 & /87 Connectors.
- H - (No Terminus spec): For use in D*M Mark I, G06, E2P (DIN) Fiber Optic/Coaxial Housing.

HOLE SIZE (MICRONS)* - JEWEL

1219	1321	1422	1650	2200	2400	2600	2800
1245	1346	1447	1700	2250	2450	2650	
1270	1372	1550	1750	2300	2500	2700	
1295	1397	1600	1800	2350	2550	2750	

HOLE SIZE (MICRONS)* - CERAMIC TIP

1250	1400	1700
1270	1420	1720
1290	1440	1740

ALIGNMENT SYSTEM

J - Jewel, Synthetic Ruby

P - Precision Ceramic Tip

PREFORM

P - Preform Epoxy Supplied (available for terminus/connector series A, B and G only)

N - No Preform Epoxy Supplied

*For Size not listed, consult factory.

How to Order Fiber Optic Receptacles (Mates with MIL-T-29504/4 Contacts)

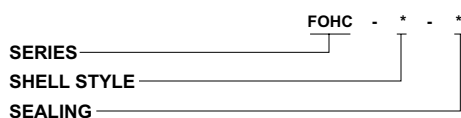

SERIES - Fiber Optic Hybrid Contacts

SHELL STYLE

- 3 - Receptacle, Device, PCB Mount
- 4 - Receptacle, Device, Flange Mount
- 7 - Receptacle, Adapter, In-Line Cable Panel Mount

SEALING

N - Non-Sealed

S - Sealed



Adapter for in-line cable mechanical splice.



Receptacle for mounting T0-18/T0-46/T0-52 devices.

ITT Cannon's EOMC Series Fiber Optic connectors are designed to meet the needs of military and commercial customers who require a rugged environmental multifiber field connector. The FOMC combines features which provide the user with a connector that will withstand rough handling and weather extremes with features of elastomeric cable and interface sealing, scoop proof interface to prevent optical contact damage, removable front insert for easy optical contact cleaning, anodized shell finish, and a tough, strong dust cap with attaching stainless steel strap.

Hermaphroditic design means plugs will mate with an identical plug as well as receptacles. The removable insert assures correcting mating and alignment. In the FOMC, ruggedness is combined with good optical performance, rapid coupling and attractive pricing. Another plus feature for ITT Cannon's FOMC design is the fiber flexure chamber which prevents tensile loads from being applied to the terminated fiber. The chamber provides space for surplus fiber in a service loop of sufficient length to permit one retermination of one or more fibers in the plug and cable receptacle without reterminating the strength member at the same time. This versatility is an ITT Cannon exclusive.

The FOMC 2, 4, and 8 channel connector are available as a cable plug, and several receptacle shell configurations. The 8 channel can also be used with less contacts i.e. 6,4, or 2 channels. Sealing plugs are supplied with the 8 channel connector when using less than the full complement of contacts. This catalog provides complete ordering information on available shell types, contact layouts, fiber and cable dimensional and mechanical parameters.



State-of-the-art ceramic alignment tips on the contact provide maximum coupling performance - less than 1.0 dB average coupling loss.

Standard Data

Fungus inert per requirement 4 of MIL-STD-454 Fluid resistant (elastomeric materials) per
 MIL-H-5606-Hydraulic fluid, petroleum base
 MIL-L-7808-Lubricating oil, synthetic base
 MIL-G-3056-Gasoline
 MIL-A-8243-Ethylene glycol

Description	Materials
Shell Hardware	Aluminum Alloy
Cable Clamp	Aluminum Alloy
Insert, Front Removable	Thermoplastic
Interfacial Seal	Elastomer
Cable Seal	Elastomer
O Rings	Elastomer
Alignment Guide	Thermoplastic
Strain Relief Spring	Stell wire with black chrome finish
Mandrel/Yoke	Thermoplastic
Receptacle Yoke	Thermoplastic
Dust Cap	Elastomer
Marking	Laser with clear chromate over exposed base metal

Contact Arrangements

Face View of Insert

2 and 4 Channel

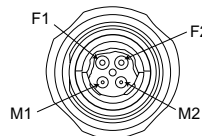
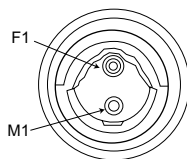

8 Channel

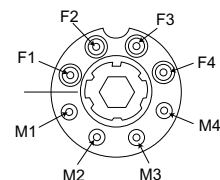

How to Order

SERIES

Fiber Optic Multi-Channel

SHELL STYLE

2 - Square Flange Receptacle
(2/4) channel only

6 - Cable Plug

7 - Jam Nut Receptacle

SHELL SIZE (Channels)

(Maximum number of contact positions)

2

4

8

DUST CAP

W - Connector supplied with dust cap

X - Without dust cap

CABLE TYPE

1 - Pigtail buffered fiber (receptacle only)

2 - Multi fiber strengthened cable

3 - Singel fiber strengthened cables (8 channel only)

SERIES

SHELL STYLE

SHELL SIZE

DUST CAP

CABLE TYPE

CABLE SIZE (O.D)

POLARIZATION POSITION

MODIFICATION CODES

CABLE SIZE (O.D)

A - .190 ±.015 (4.83 ±.38)

D - .236 ±.019 (6.0 ±.5)

F - .276 ±.015 (7.0 ±.4)

G - .374 ±.015 (9.50 ±.38)*

H - .500 ±.015 (12.70 ±.38)*

P - Pigtail buffered fiber

*NOTE: Cable size G and H are for 8 channel FOMC Connector only

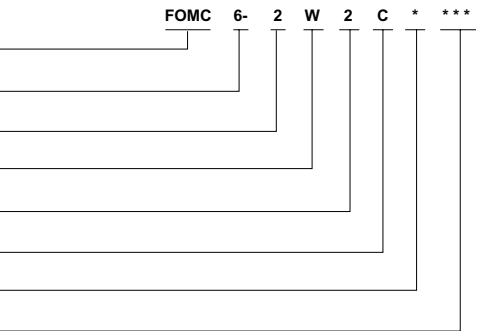

POLARIZATION

(8 channel plug only. Omit for 2/4 channel)

0 - Not polarized

1 thru 6 - key position

MODIFICATION CODES

Consult factory

2 and 4 Channel

Square Flange Receptacle

FOMC 2

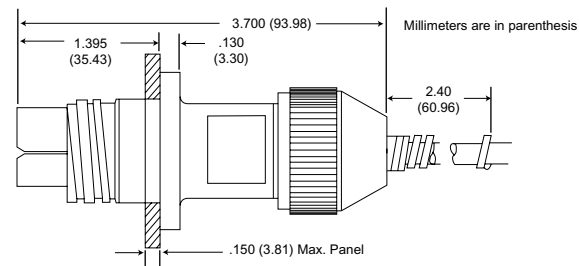
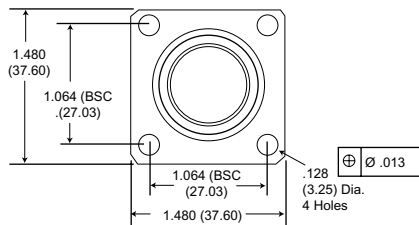

Plug

FOMC 6

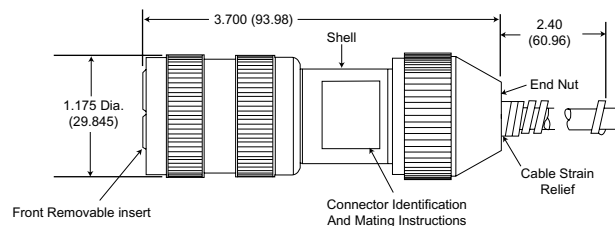
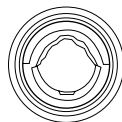

Jam Nut Receptacle

FOMC 7

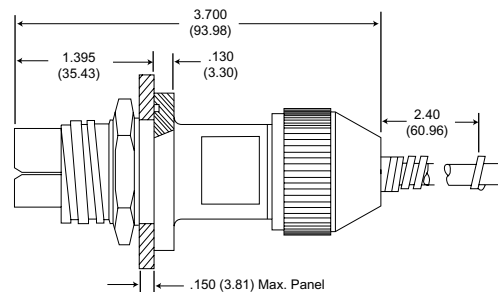
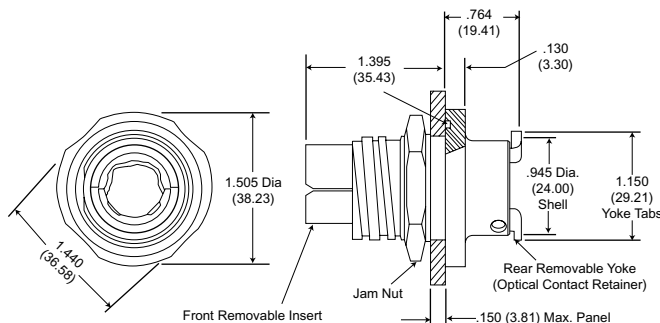

Contact Assembly

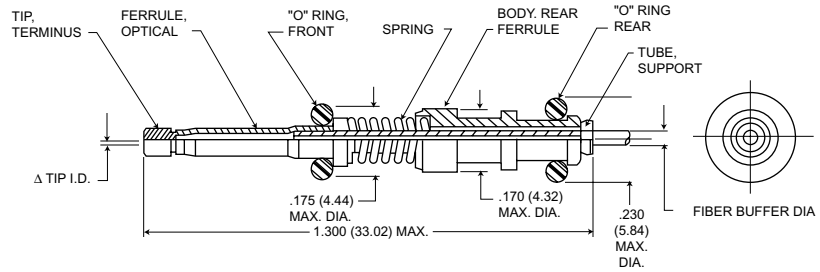

How to Order - Contacts

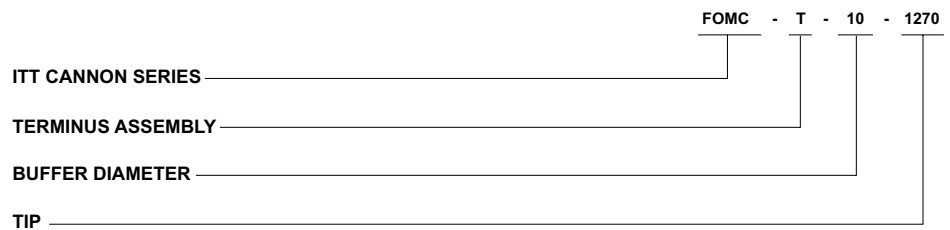

SERIES

FOMC - Fiber Optic Multi-Channel

▲ TIP (I.D. in tenths of microns)

1270 - 127.0 μm min.

1300 - 130.0 μm min.

1440 - 144.0 μm min.

TERMINUS ASSEMBLY

■ BUFFER DIAMETER (in millimeters)

05 - 0.5 mm Buffer

10 - 1.0 mm Buffer

11 - 1.1 mm Buffer

Coupling Performance

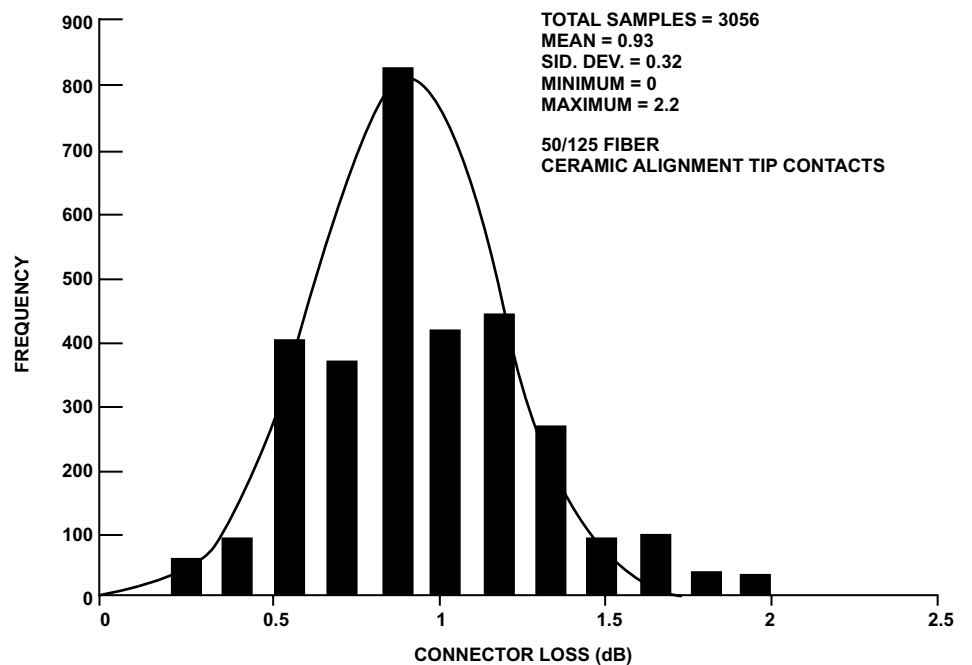

Fiber Optic Cable Assemblies

ITT Cannon is a major supplier of fiber optic cable assemblies for multichannel tactical ground based and avionics applications. Experienced includes delivery of more than 20,000 custom fiber optic links over the past twelve years. Cable assemblies are built to specific design requirements and are 100% optically tested.

FOMC

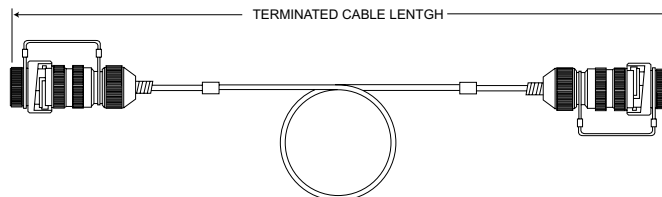

FOMC Plug-to-Plug Assembly

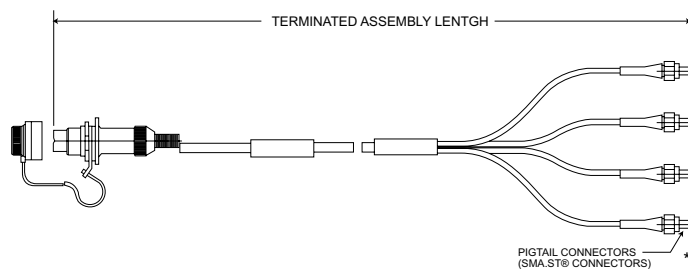

FOMC Receptacle/Pigtail Assembly

*ST is a trademark of AT&T

FOHC

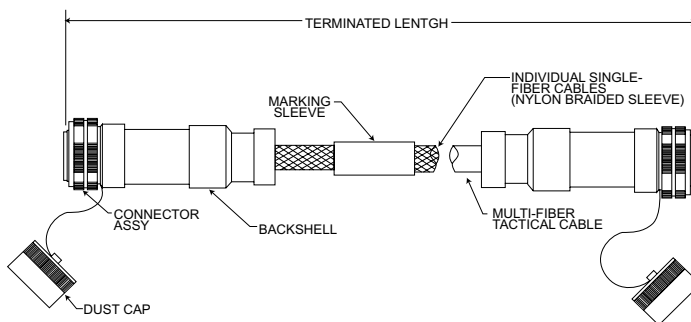

38999 F.O. Plug-to-Plug Assembly

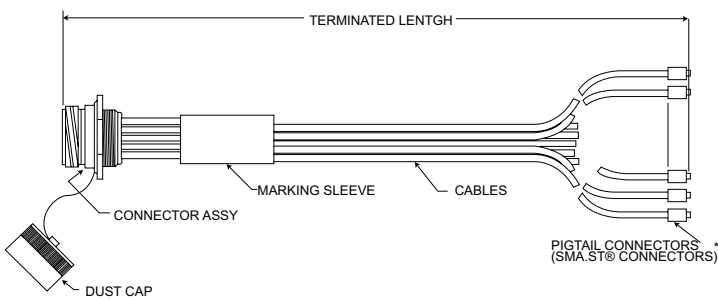

38999 F.O. Receptacle/Pigtail Assembly

*ST is a trademark of AT&T



ITT Cannon has developed a line of filter connectors to meet the industry's demand for improved control of Radio Frequency and Electro-Magnetic Interference (RFI/EMI). These TD1* filter connectors, have been designed to combine the functions of a standard electrical connector and feed-thru filters into one compact package. In addition to offering greater design flexibility and system reliability, they are designed for applications where space and weight are prime considerations. These connectors are intermateable with all standard D subminiature

connectors. They are also intermateable with MIL-C-24308 types and meet applicable portions of that specification.

ALL TD1* filter contact assemblies are tested 100% during in-process and final inspection, for capacitance, insulation resistance and dielectric withstanding voltage. Attenuation is checked as required for each type of filter to assure performance to guaranteed levels.

Note: The TD1* replaces the obsolete TD*J and D*J Series

How to Order

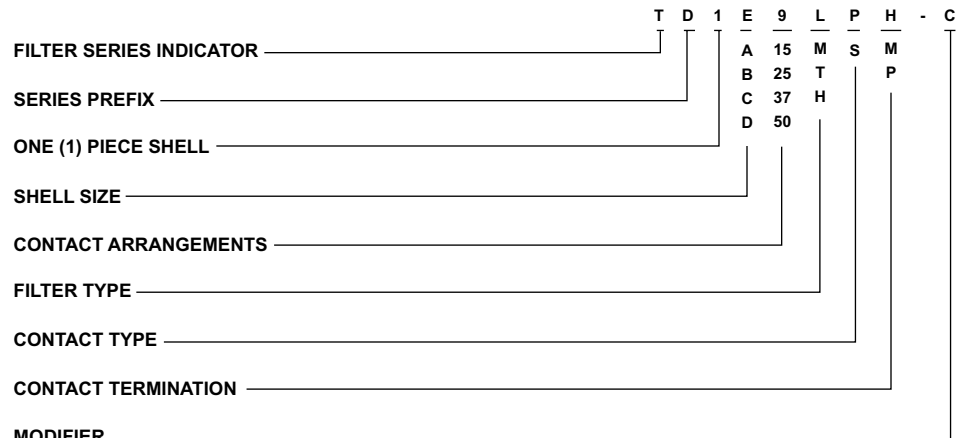

FILTER SERIES INDICATOR

T - Transverse Monolith

SERIES PREFIX

D - Miniature, rectangular, solder termination

SHELL SIZE (one piece shell)

E, A, B, C, D

CONTACT ARRANGEMENTS

See page 305

MODIFIER

FILTER TYPE

- L - Low frequency
- M - Mid-range frequency
- T - Standard frequency
- H - High frequency

CONTACT TYPE

- P - Pin contacts
- S - Socket contacts

PRINTED CIRCUIT CONTACTS

Consult factory. Both 90° and straight types are available.

CONTACT TERMINATION

See page 305

Lack of termination indicator signifies solder cup.

MODIFIER

C - Clinch nut

Performance and Material Specifications

ELECTRICAL DATA

Available Filter	Low Freq.	Mid Freq.	Std Freq.	High Freq.	
Catalog Indication - letter	L	M	T	H	
Voltage Rating (working)	100 VDC		200 VDC		
Current Rating (amp DC)	7.5	7.5	7.5	7.5	
Insulation Resistance, 2 min. electrification time max. at 25° C, and 100 VDC	5000 megohms minimum	10,000 megohms minimum	10,000 megohms minimum	10,000 megohms minimum	
DWV, sea level, with 500 microamps max. charge/discharge	300 VDC	500 VDC	500 VDC	500 VDC	
Capacitance at 1 KHz, 0.1 V rms picofarads	50,000 minimum	7200 12,000	3000 5,000	780 1,300	
	Freq. MHz		Attenuation (dB)		
Attenuation per MIL-STD-220 @ 25° C with no applied voltage or current.	0.1	2 min.	-	-	
	1	15 min.	2 min.	-	
	2	20 min.	5 min.	2 min.	
	10	35 min.	15 min.	9 min.	2 min.
	100	60 min.	55 min.	50 min.	30 min.
	500 to 10,000	65 min.	60 min.	55 min.	50 min.
Filter Type	Pi	Pi	Pi	Pi	

MATERIALS AND FINISHES

Description	Material	Finish
Contacts	Copper alloy	Gold plate per MIL-G-45204 Type 1, Class 1
Shell	Aluminum alloy 6061-T6 per QQ-A-225/8 or QQ-A-200/8	Electroless nickel per MIL-C-26074
Insulator: Socket	Polyphenylene Sulfide/ Epoxy	None
Pin	Epoxy	None
Ground Spring	Beryllium Copper	Silver plate

Contact Arrangements

Face View Pin Insert

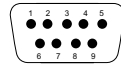

E
9
#20

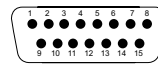

A
15
#20

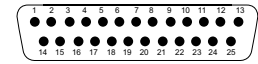

B
25
#20

Shell Size
Contact Arrangement
Contact Size

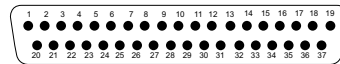

C
37
#20

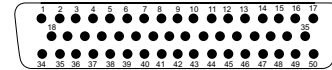

D
50
#20

Shell Size
Contact Arrangement
Contact Size

Contacts

Straight Printed Circuit

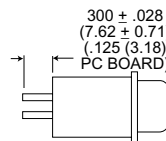

Modifier

H: .040 (1.02) Dia. terminals and accommodates up to 1/8 Max. thick P.C. boards.

M: .030 (.76) Dia. terminals and accommodates up to 1/8 Max. thick P.C. boards.

Right Angle Printed Circuit

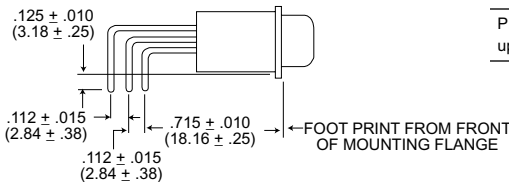
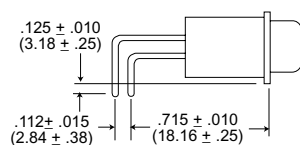

Modifier

P: .030 (.76) Dia. terminals and accommodates P.C. boards up to 3/32 Max. Thickness.

Standard Shell Dimensions

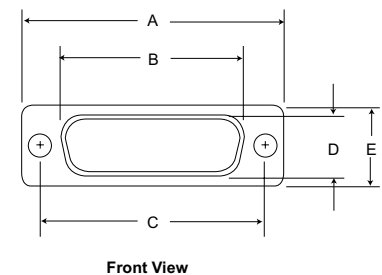
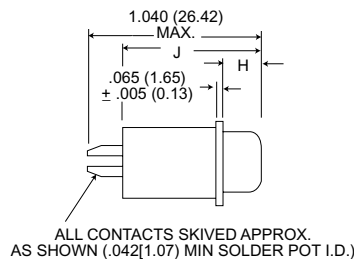
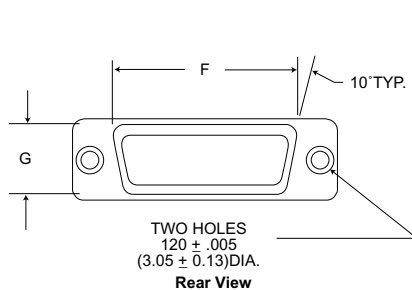

Shell Size	A ± .015 (0.38)	B ± .010 (0.25)	C ± .005 (0.13)	D ± .010 (0.25)	E ± .005 (0.13)	F ± .010 (0.25)	G ± .010 (0.25)	H ± .010 (0.25)	J ± .010 (0.25)
9P	1.213 (30.81)	.738 (18.75)	.984 (24.99)	.400 (10.16)	.502 (12.75)	.792 (20.12)	.469 (11.91)	.236 (5.99)	.841 (21.36)
9S	1.213 (30.81)	.642 (16.31)	.984 (24.99)	.310 (7.87)	.502 (12.75)	.792 (20.12)	.469 (11.91)	.243 (6.17)	.852 (21.64)
15P	1.541 (39.14)	1.066 (27.08)	1.312 (33.32)	.400 (10.16)	.502 (12.75)	1.116 (28.35)	.469 (11.91)	.236 (5.99)	.841 (21.36)
15S	1.541 (39.14)	.970 (24.64)	1.312 (33.32)	.310 (7.87)	.502 (12.75)	1.116 (28.35)	.469 (11.91)	.243 (6.17)	.852 (21.64)
25P	2.087 (53.01)	1.606 (40.79)	1.852 (47.04)	.400 (10.16)	.502 (12.75)	1.664 (42.27)	.469 (11.91)	.231 (5.87)	.841 (21.36)
25S	2.087 (53.01)	1.510 (38.35)	1.852 (47.04)	.310 (7.87)	.502 (12.75)	1.664 (42.27)	.469 (11.91)	.243 (6.17)	.852 (21.64)
37P	2.729 (69.32)	2.254 (57.25)	2.500 (63.50)	.400 (10.16)	.502 (12.75)	2.316 (58.83)	.469 (11.91)	.231 (5.87)	.841 (21.36)
37S	2.729 (69.32)	2.158 (54.81)	2.500 (63.50)	.310 (7.87)	.502 (12.75)	2.316 (58.83)	.469 (11.91)	.243 (6.17)	.852 (21.64)
50P	2.635 (66.93)	2.151 (54.64)	2.406 (61.11)	.512 (13.00)	.612 (15.54)	2.198 (55.83)	.576 (14.63)	.231 (5.87)	.841 (21.36)
50S	2.635 (66.93)	2.064 (52.43)	2.406 (61.11)	.422 (10.72)	.612 (15.54)	2.198 (55.83)	.576 (14.63)	.243 (6.17)	.852 (21.64)

Mounting Panel Cutout Dimensions

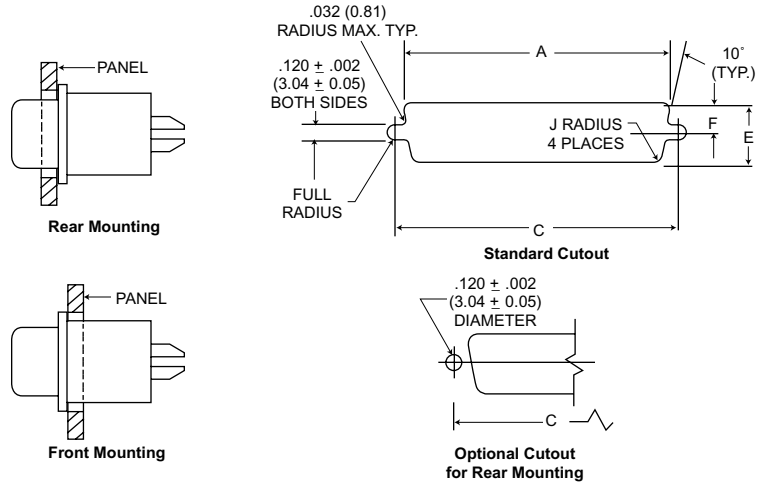

Connector	Mounting Method	A		C		E		F		J	
		$\pm .005 (0.13)$	$\pm .005 (0.13)$	$\pm .005 (0.13)$	$\pm .005 (0.13)$	$\pm .005 (0.13)$	$\pm .005 (0.13)$	$\pm .005 (0.13)$	$\pm .005 (0.13)$	$\pm .005 (0.13)$	$\pm .005 (0.13)$
TD1E	Front Mounting	.833 (21.16)	.984 (24.99)	.485 (12.32)	.243 (6.17)	.065 (1.65)					
	Rear Mounting	.806 (20.47)	.984 (24.99)	.449 (11.40)	.225 (5.72)	.132 (3.35)					
TD1A	Front Mounting	1.161 (29.49)	1.312 (33.32)	.485 (12.32)	.243 (6.17)	.065 (1.65)					
	Rear Mounting	1.134 (28.80)	1.312 (33.32)	.449 (11.40)	.225 (5.72)	.132 (3.35)					
TD1B	Front Mounting	1.700 (43.18)	1.852 (47.04)	.485 (12.32)	.243 (6.17)	.065 (1.65)					
	Rear Mounting	1.674 (42.52)	1.852 (47.04)	.449 (11.40)	.225 (5.72)	.132 (3.35)					
TD1C	Front Mounting	2.349 (59.66)	2.500 (63.50)	.485 (12.32)	.243 (6.17)	.065 (1.65)					
	Rear Mounting	2.326 (59.08)	2.500 (63.50)	.449 (11.40)	.225 (5.72)	.132 (3.35)					
TD1D	Front Mounting	2.254 (57.25)	2.406 (61.11)	.593 (15.06)	.297 (7.54)	.065 (1.65)					
	Rear Mounting	2.218 (56.34)	2.406 (61.11)	.555 (14.09)	.278 (7.06)	.132 (3.35)					



- Transverse monolith filter for EMI/RFI shielding
- Rugged aluminum one-piece shell
- Silicone interfacial environmental seal
- Glass-filled diallyl phthalate insulator
- Meets applicable portion of MIL-Spec.

TMDM connectors are extremely small filter connectors with higher contact density than traditional rectangular connectors making them ideally suited for applications where space is limited and EMI and RFI filtering is required. The TMDM receptacle accommodates from 9 to 37 size 24 socket contacts on .050 (1.27) centers and mates with the ITT Cannon MDM plug utilizing reliable, proven, "twist pin" contacts.

How to Order

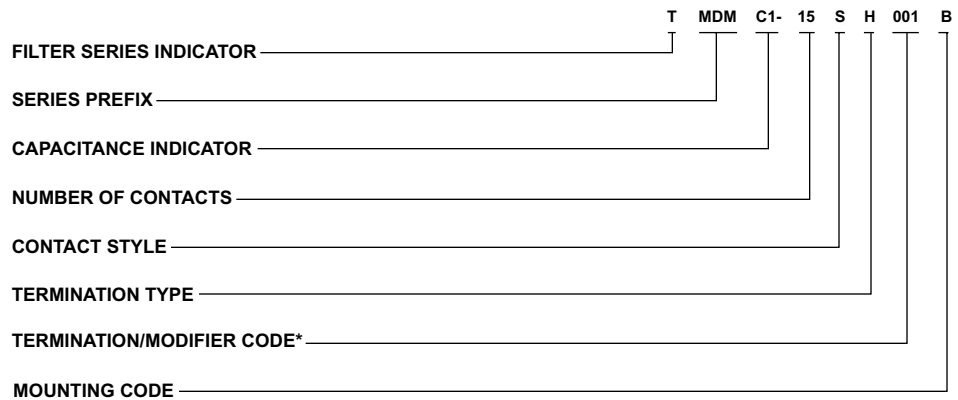

FILTER SERIES INDICATOR

T - Transverse Monolith

SERIES PREFIX

MDM - Micro "D" - Metal Housing

CAPACITANCE INDICATOR

"C" Capacitor Type

- C1 150-250 pf capacitance
- C2 300-500 pf capacitance
- C3 700-1000 pf capacitance
- C4 1300-2000 pf capacitance

NUMBER OF CONTACTS

9, 15, 21, 25, 31, 37 only

CONTACT STYLE

S - Socket (Receptacle) only

TERMINATION TYPE

- H - Harness, insulated solid or stranded wire
- L - Lead, solid uninsulated wire

TERMINATION/MODIFIER CODE*

Consult "L" & "H" modification codes for lead material and lead length.

MOUNTING CODE

- A - Flange mounting (.125 (3.18) dia. mtg. holes)
- B - Flange mounting (.092 (2.34) dia. mtg. holes)
- K - Jackscrew (standard, slotted head)
- KL - Low profile jackscrew (slotted head)
- I - Low profile jackscrew (hex head)
- LS - Low profile jackscrew (spline head)
- M1 - Allen head lockscrew assy.
- M2 - Allen head jackscrew assy., low profile
- M3 - Allen head jackscrew assy., high profile
- M4 - Slot head lockscrew assy.
- M5 - Slot head jackscrew assy., low profile
- M6 - slot head jackscrew assy., high profile
- P - Jackpost
- S - Clinch nut, #2-56 stainless steel

* See termination codes listed for additional length modification codes (page 308).

For other modifications not listed, consult factory.

Performance and Material Specifications

MATERIALS AND FINISHES

Shell	Aluminum alloy per QQ-A-200/8 with fused tin over copper
Socket Contact	Copper alloy, 50 microinch gold per MIL-G-45204, Type II, Class 1
Insulator	Glass-filled diallyl phthalated per MIL-M-14, type SDGF
Interfacial Seal	Silicone base rubber

ELECTRICAL DATA

No. of Contacts	9 thru 37
Dielectric Withstanding Voltage	300 VDC
Insulation Resistance	5,000 Megohms @ 100 VDC
Voltage Rating (Working)	100 VDC
Current Rating	3 amps max.
Max. Capacitance (Picofarads)	250, 500, 1000, 2000
Filter Type	C

MECHANICAL FEATURES

Size or length	6 sizes
Coupling	Friction/jackscrews
Polarization	Keystone-shaped shell
Contact Spacing	.050 (1.27) centers
Shell Style	Single piece receptacle

Guaranteed Minimum Attenuation

Filter Designation	Capacitance Range (pF)	Minimum Insertion Loss - Decibels							
		10 MHz	15 MHz	30 MHz	50 MHz	100 MHz	200 MHz	500 MHz	1 GHz
C1	150-250				4	6	15	20	35
C2	300-500			3	6	12	18	25	40
C3	700-1000		3	7	13	17	25	38	48
C4	1300-2000	5	8	13	18	23	30	40	50

Standard Wire Termination Codes

Harness Type (H) #26 AWG per MIL-W-16878/4 Type E Teflon, stranded.

Length	All Yellow	Color Coded
3 (76.2)	H020	H027
6 (152.4)	H019	H016
8 (203.2)	H026	H034
10 (254.0)	H029	H025
12 (304.8)	H028	H002
18 (457.2)	H001	H003
20 (508.0)	H038	H023
24 (609.6)	H009	H004
30 (762.0)	H010	H005
36 (914.4)	H011	H006
48 (1219.2)	H013	H048
72 (1828.8)	H017	H046
120 (3048.0)	H042	H041

Solid Uninsulated Type (L) #25 AWG gold plated copper

Code	Length
L61	.125 (.18)
L56	.150 (3.81)
L57	.190 (4.83)
L39	.250 (6.35)
L58	.375 (9.52)
L1	.500 (12.70)
L14	.750 (19.05)
L2	1.000 (25.40)
L7	1.500 (38.10)
L6	2.000 (50.80)
L16	2.500 (63.50)
L10	3.000 (76.20)

Cannon Modification Codes - (Not MS)

For lengths not shown, consult factory for proper modification code. All wire lengths are minimum.

Shell Dimensions

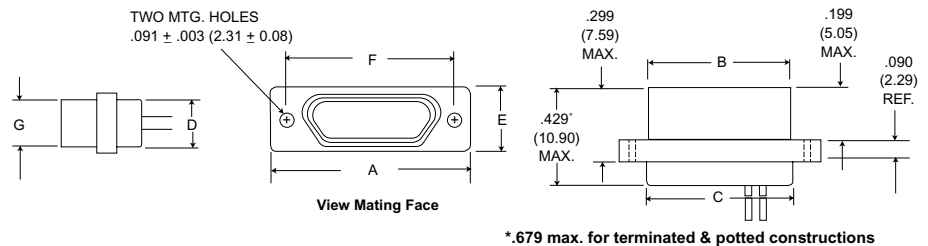

Part Number by Shell Size	A Max.	B Max.	C Max.	D Max.	E Max.	F ± .005 (0.13)	G Max.
TMDM-9S*	.785 (19.94)	.400 (10.16)	.400 (10.16)	.270 (6.86)	.308 (7.82)	.565 (14.35)	.251 (6.38)
TMDM-15S*	.935 (23.75)	.550 (13.97)	.550 (13.97)	.270 (6.86)	.308 (7.82)	.715 (18.16)	.251 (6.38)
TMDM-21S*	1.085 (27.56)	.700 (17.78)	.700 (17.78)	.270 (6.86)	.308 (7.82)	.865 (21.97)	.251 (6.38)
TMDM-25S*	1.185 (30.10)	.800 (20.32)	.800 (20.32)	.270 (6.86)	.308 (7.82)	.965 (24.51)	.251 (6.38)
TMDM-31S*	1.335 (33.91)	.950 (24.13)	.950 (24.13)	.270 (6.86)	.308 (7.82)	1.115 (28.32)	.251 (6.38)
TMDM-37S*	1.485 (37.72)	1.100 (27.94)	1.100 (27.94)	.270 (6.86)	.308 (7.82)	1.265 (32.13)	.251 (6.38)

* Add Filter type, Lead Type and Length; see How to Order.

NOTE: 1) Potting extension of .250 (6.35) Max. required for insulated wire termination.

2) PC tails of .019 (0.48 ± .002 (0.05) diameter are available. The PC tail length is to be specified from the rear of the shell to the end of the termination.



These miniature circular filter connectors are designed to combine the functions of a standard electrical connector and a feed-thru filter into one compact package.

TPV filter connectors are designed to meet the applicable portions of military specifications MIL-C-26482 and MIL-C-83723. They are also

intermateable with the NAS1599 and the NASA 40M39569 type connectors. These connectors feature three-point bayonet lock coupling, five keyway polarization, and have contact arrangements that will accommodate up to 61 contacts in shell sizes, with both pin and socket contact versions available.

Note: The TPV replaces the obsolete PVJ Series

How to Order - TPV

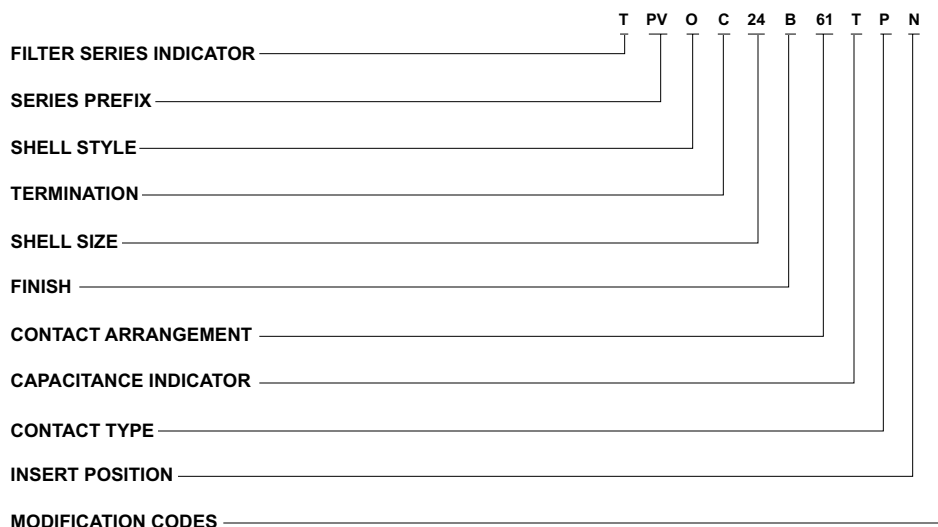

FILTER SERIES INDICATOR

T - Transverse monolith

SERIES PREFIX

PV - MIL-C-26482 Series 2, MIL-C-83723

Series 1 type filter connectors, solder termination. ITT Cannon designation.

SHELL STYLE

0 - Flange mounting receptacle

7 - Jam nut mounting receptacle

TERMINATION

C - Solder Pot Termination

E - P.C. Tail

S - Crimp Piggyback

W - Wire Wraps

SHELL SIZE

10, 12, 14, 16, 18, 20, 22, 24

FINISH

A - Bright cadmium over nickel plate

B - Olive drab chromate over cadmium finish

G - Electroless nickel finish (preferred)

CONTACT ARRANGEMENTS

See page 311

CAPACITANCE INDICATOR

M - Mid-range frequency

L - Low frequency

T - Standard frequency

H - High frequency

CONTACT TYPE

P - Pin contacts

S - Socket contacts

INSERT POSITION

N - (Normal); Alternates - W, X, Y, Z

See page 162.

MODIFICATION CODES

For backshell assembly consult factory.

NOTES:

1) Backshell threads and teeh - none provided.

2) Hermetic versions of the filter connectors can be provided. Consult ITT Cannon for availability.

Performance and Material Specification

MATERIALS AND FINISHES

Jam Nut	Material:	Aluminum Alloy	
	Finish:	Class "B" Series	Class "G" Series
		Olive drab chromeplate over cadmium finish per QQ-P-416	Electroless nickel plating Per MIL-C-26074
Coupling Pins	Material:	Copper Alloy	
	Finish:	Passivated	
Contacts	Material:	Copper Alloy	
	Finish:	Gold plated per MIL-G-45204, Type 1 Class 1 with nickel underplate per QQ-N-290	
Insulator	Material:	Suitable high temperature plastic/epoxy	
	Finish:	none	
Interfacial and Peripheral Seals	Material:	Fluorosilicone rubber (ITT Cannon blend)	
	Finish:	none	
O ring (Jam Nut Mounting Only)	Material:	Silicone rubber (ITT Cannon blend)	
	Finish:	none	
Ground Spring	Material:	Beryllium Copper	
	Finish:	Silver Plated	

ELECTRICAL (Size #16 and #20 Contacts)

Filter Description	Low Freq.	Mid Freq.	Std. Freq.	High Freq.
Catalog Indicator	L	M	T	H
Voltage Rating	200 VDC - 120 VAC rms 400 Hz			
Current Rating (amp DC)	15 amp, size 16/7.5 amp, size 20			
Insulation Resistance, 2 min. electrification time max. at 25°C	5000, megohms min. @ 100 VDC			
DWV, sea level, with 500 microamps max. charge/discharge	500 VDC size 16 & 20		500 VDC	
Capacitance at 1 KHz 0.1V rms Picofarads	32000	8000	3300	850
	45000	12000	5000	1300
Attenuation per MIL-STD-220 @ 25°C with no applied voltage or current.	Freq. MHz			
	0.1	2 min.	-	-
	1.0	10 min.	2 min.	-
	2	16 min.	7 min.	2 min.
	10	40 min.	18 min.	8 min.
	100	60 min.	55 min.	45 min.
	500 to 1000	70 min.	60 min.	55 min.
Filter Type/Construction	Pi	Pi	Pi	Pi

Consult factory for higher or mixed attenuation values and higher voltage ratings.

Contact Arrangements

(Face view, pin insert)

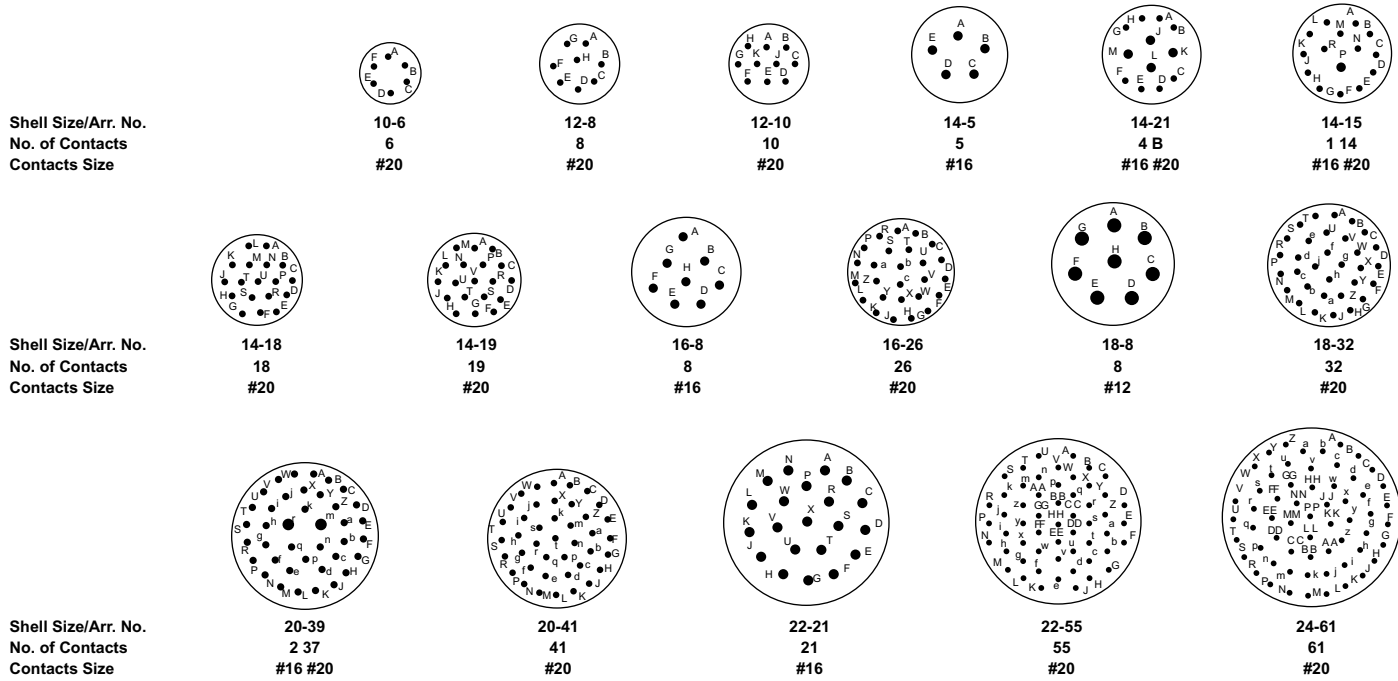

Consult factory for availability of other contact arrangements. Availabl for In-Line Adapters also.

Alternate Polarizing Positions - Page 162

Contact - Pin and Socket

Standard Contact Terminations

Finish: Gold plate per MIL-G-45204, Type 1,
Class 1, over nickel plate per QQ-N-290.

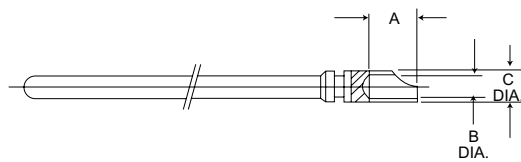

Pin/Solder Pot

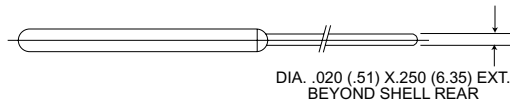

Pin/Printed Circuit

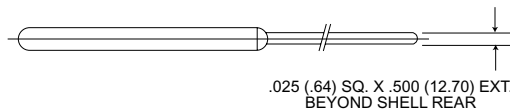

Pin/Wire Wrap

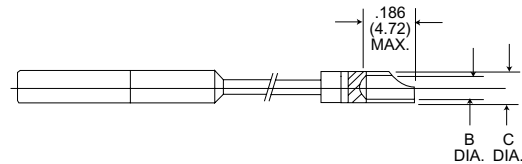

Socket/Solder Pot

Contact Size	A	B Dia.	C Dia.
#20	.125 (3.18)	.049 (1.24)	.073 (1.85)
	.110 (2.79)	.045 (1.14)	.068 (1.73)
#16	.160 (4.06)	.077 (1.96)	.104 (2.64)
	.150 (3.81)	.068 (1.73)	.097 (2.46)

Note: Solder pot extension typically will be .200 (5.08) max. beyond shell rear.

Flange Mounting Receptacle

TPV0

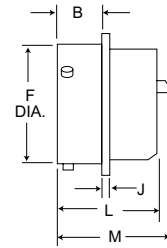
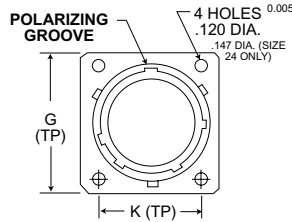

Shell Size	B Max.	F Max.	L Max.	M Max.	J Max.	K Basic	G Max.
10	.462 (11.73)	.591 (15.01)	1.215 (30.86)	1.530 (38.86)	.078 (1.98)	.719 (18.26)	.954 (24.23)
12	.462 (11.73)	.751 (19.08)	1.215 (30.86)	1.530 (38.86)	.078 (1.98)	.812 (20.62)	1.047 (26.59)
14	.462 (11.73)	.876 (22.25)	1.215 (30.86)	1.530 (38.86)	.078 (1.98)	.906 (23.01)	1.141 (28.98)
16	.462 (11.73)	1.001 (25.43)	1.215 (30.86)	1.530 (38.86)	.078 (1.98)	.969 (24.61)	1.234 (31.34)
18	.462 (11.73)	1.126 (28.60)	1.215 (30.86)	1.530 (38.86)	.078 (1.98)	1.062 (26.97)	1.328 (33.73)
20	.587 (14.91)	1.251 (31.78)	1.275 (32.39)	1.590 (40.38)	.110 (2.79)	1.156 (29.36)	1.453 (36.91)
22	.587 (14.91)	1.376 (34.95)	1.275 (32.39)	1.590 (40.38)	.110 (2.79)	1.250 (31.75)	1.578 (40.08)
24	.620 (15.75)	1.501 (38.13)	1.275 (32.39)	1.590 (40.38)	.110 (2.79)	1.375 (34.93)	1.703 (43.26)

Jam Nut Receptacle

TPV7

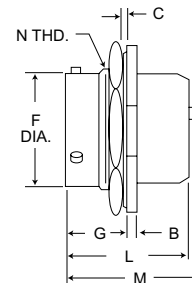
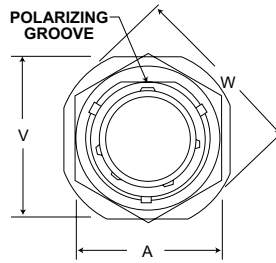

Shell Size	V Max.	A Max.	B Max.	F Max.	G ± .009 (0.23)	C Panel Thickness	L Max.	M Max.	W Dia.	N Thread Class 2A
10	1.078 (27.38)	.892 (22.66)	.113 (2.87)	.591 (15.01)	.698 (17.73)	.187 (4.75)	1.215 (30.86)	1.530 (38.86)	1.203 (30.56)	11/16-24UNEF
12	1.266 (32.16)	1.079 (27.41)	.113 (2.87)	.751 (19.08)	.698 (17.73)	.187 (4.75)	1.215 (30.86)	1.530 (38.86)	1.391 (35.33)	7/8-20 UNEF
14	1.391 (35.33)	1.205 (30.61)	.113 (2.87)	.876 (22.25)	.698 (17.73)	.187 (4.75)	1.215 (30.86)	1.530 (38.86)	1.516 (38.51)	1-20UNEF
16	1.516 (38.51)	1.329 (33.76)	.113 (2.87)	1.001 (25.43)	.698 (17.73)	.187 (4.75)	1.215 (30.86)	1.530 (38.86)	1.641 (41.68)	1-1/8-18UNEF
18	1.641 (41.68)	1.455 (36.96)	.113 (2.87)	1.126 (28.60)	.698 (17.73)	.187 (4.75)	1.215 (30.86)	1.530 (38.86)	1.766 (44.86)	1-1/4-18UNEF
20	1.828 (46.43)	1.579 (40.11)	.148 (3.76)	1.251 (31.78)	.763 (19.38)	.250 (6.35)	1.275 (32.39)	1.590 (40.39)	1.954 (49.63)	1-3/8-18UNEF
22	1.954 (49.63)	1.705 (43.31)	.148 (3.76)	1.376 (34.95)	.763 (19.38)	.250 (6.35)	1.275 (32.39)	1.590 (40.39)	2.078 (52.78)	1-1/2-18UNEF
24	2.078 (52.78)	1.829 (46.46)	.148 (3.76)	1.501 (38.13)	.763 (19.38)	.219 (5.56)	1.275 (32.39)	1.590 (40.39)	2.203 (55.96)	1-5/8-18UNEF

MIL-C-38999 Series I, II, III, IV Filter Connectors



These miniature circular filter connectors are designed to combine the functions of a standard electrical connector and a feed-thru filter into one compact package. They are designed to meet the applicable portions of military specification MIL-C-38999 series I, II, III and IV. These connectors feature arrangements that will accommodate up to 12B contacts. Consult factory for socket versions.

For detailed dimensional information, request a copy of the ITT Cannon *Filter Connectors* catalog.

Note: The TKJ replaces the obsolete KJJ Series

How to Order - TKJL/TKJ/TKJA/TKJB

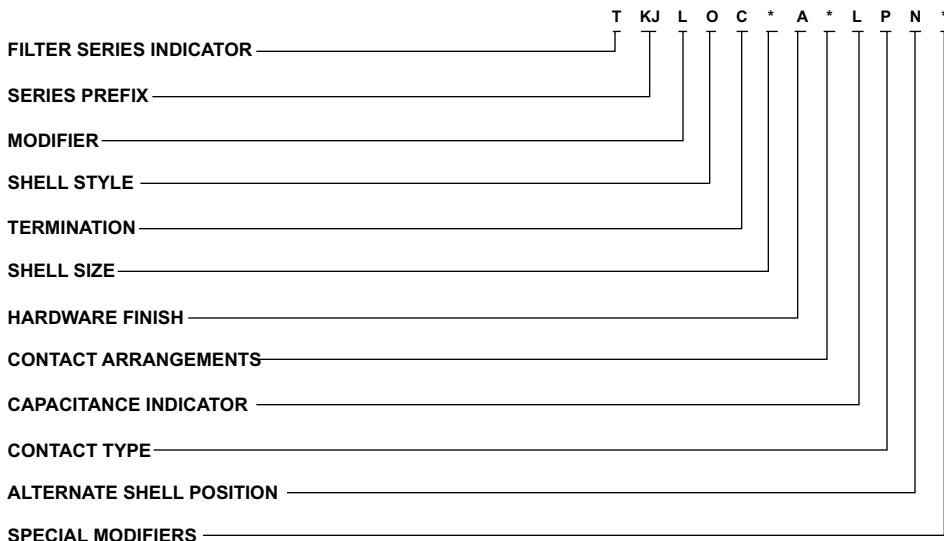

FILTER SERIES INDICATOR

T - Transverse Monolith

SERIES PREFIX

KJ - ITT Cannon prefix

MODIFIER

- L - Series I scoop-proof shell (omit if Series II desired)
- A - Series III Triple Start Thread (omit if Series II desired)
- B - Series IV - Available in receptacle only (omit if Series II desired)

SHELL STYLE

- 0 - Wall mounting receptacle (front panel mounting)
- 2 - Box mounting (front panel mounting)
- 3 - Wall mounting (black panel mounting)
- 5 - Box mounting receptacle (back panel mounting)
- 7 - Jam nut receptacle

NOTES:

- 1) Backshell thread and teeth.
Series I and II - Provided only on shell types indicated on dimension sheets.
Series III - No threads or teeth provided.
Series IV - Provided with threads and teeth.
- 2) Hermetic versions of the filter connectors can be provided. Consult ITT Cannon for availability.
- 3) Series III and IV can only be shell style 0 or 7.

TERMINATION

- C - Solder pot termination
- E - P.C. tails
- S - Crimp Piggyback
- W - Wire wraps

SHELL SIZE

- Series I, III and IV:
11, 13, 15, 17, 19, 21, 23, and 25
- Series II:
10, 12, 14, 16, 18, 20, 22, and 24

HARDWARE FINISH

- A - Bright cadmium over nickel plate
- B - Olive drab cadmium over nickel plate
- N - Electroless nickel plate (preferred)

CONTACT ARRANGEMENTS

See page 315.

CAPACITANCE INDICATOR*

- L - 32,000-45,000 PF
- M - 8,000-12,000 PF
- T - 3,300-5,000 PF
- H - 850- 1,300 PF

CONTACT TYPE

P-pin; S-socket (Consult factory for availability of sockets)

ALTERNATE SHELL POSITION

N (normal), A, B, C, D

SPECIAL MODIFIERS

Consult factory for definition and availability

MIL-C-38999 Series I, II, III, IV Filter Connectors

Performance and Material Specifications

MATERIALS AND FINISHES

Shell	Aluminum alloy*
Insulator	High grade plastic/epoxy
Contacts	Copper alloy, gold plate
Grommet and Seal	Silicone base elastomer
Jam Nut	Aluminum alloy*
Grounding Spring	Beryllium copper, silver plate

*Finish as noted in How to Order section.

ELECTRICAL (Size #16, #20 and #22)

Filter Description	Low Freq.	Mid Freq.	Std. Freq.	High Freq.
Catalog Indicator	L	M	T	H
Voltage Rating	200 VDC - 120 VAC rms 400 Hz			
Current Rating (amp DC)	15 amp - size 16/7.5 amp - size 20/5.0 amp, size 22			
Insulation Resistance, 2 min. electrification time max. at 25°C	5,000 megohms min. @ 100 VDC			
DWV, sea level, with 500 microamps max. charge/discharge	300 VDC size 22 500 VDC size 16 & 20		500 VDC	
Capacitance at 1 KHz, 0.1 V rms Picofarads	32,000 45,000	8,000 12,000	3300 5000	850 1,300
Freq. MHz				
0.1				
1				
2				
10				
100				
500 to 1000				
Attenuation per MIL-STD-220 at 25°C with no applied voltage or current.	2 min.	-	-	-
	10 min.	2 min.	-	-
	16 min.	7 min.	2 min.	-
	40 min.	18 min.	8 min.	2 min.
	60 min.	55 min.	45 min.	30 min.
	70 min.	60 min.	55 min.	50 min.
Filter Type/Construction	Pi	Pi	Pi	Pi

Consult factory for higher or mixed attenuation values and higher voltage ratings.

Contact Extension - All Connectors

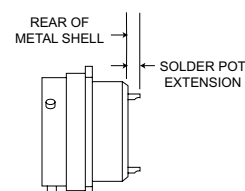

Note: Solder pot extension typically will be .200 (5.08) max. beyond shell rear.

Contact - Pin and Sockets

Standard Contact Terminations

Finish: Gold plate per MIL-G-45204, Type 1, Class 1, over nickel plate per QQ-N-290.

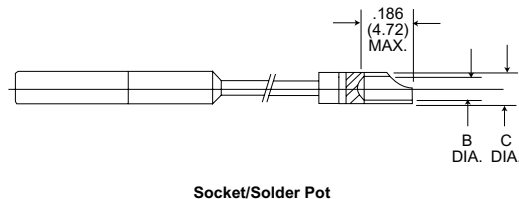
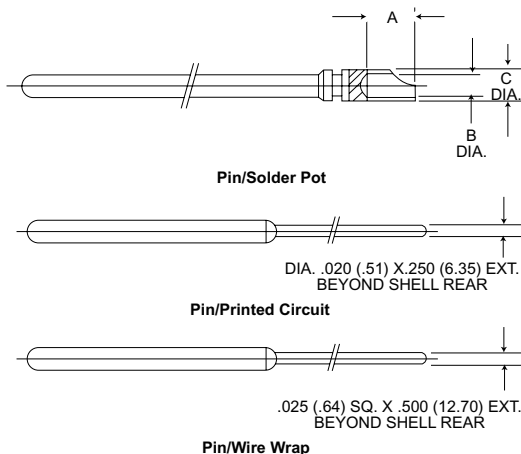

Contact Size	A	B Dia.	C Dia.
#22	.115 (2.92)	.039 (0.97)	.056 (1.42)
	.095 (2.41)	.035 (0.89)	.051 (1.30)
#20	.125 (3.18)	.047 (1.19)	.066 (1.68)
	.110 (2.79)	.042 (1.07)	.061 (1.55)
#16	.170 (4.32)	.077 (1.96)	.104 (2.64)
	.150 (3.81)	.068 (1.73)	.097 (2.46)

MIL-C-38999 Series I, II, III, IV Filter Connectors

Contact Arrangements

Engaging view, pin insert

Series I, III & IV Series II No. of Contacts Service Ratings	 9-35 6 #22D M	 11-5 5 #20 I	 11-98 6 #20 I	 11-35 13 #22D M	 13-8 8 #20 I	 13-98 10 #20 I	 13-35 22 #22D M	
Series I, III & IV Series II No. of Contacts Service Ratings	 15-5 5 #16 II	 15-18 14-18 18 #20 I	 15-19 14-19 19 #20 I	 15-35 14-35 37 #22D M	 - 16-99 21 #20, 2 #16 I	 17-8 16-8 8 #16 II	 17-26 16-26 26 #20 I	 17-35 16-35 55 #22D M
Series I, III & IV Series II No. of Contacts Service Ratings	 19-32 18-32 32 #20 I	 19-35 18-35 66 #22D M	 21-16 20-16 16 #16 II	 21-35 20-35 79 #22D M	 21-41 20-41 41- #20 I			
Series I, III & IV Series II No. of Contacts Service Ratings	 23-21 22-21 21 #16 II	 23-35 18-35 100 #22D M	 23-53 22-53 53 #20 I	 23-55 22-55 55 #20 I				
Series I, III & IV Series II No. of Contacts Service Ratings	 25-29 24-29 29 #16 I	 25-35 24-35 128 #22D M	 25-61 24-61 61 #20 I					

Please consult factory for availability of layouts not shown.

Polarizign Positions

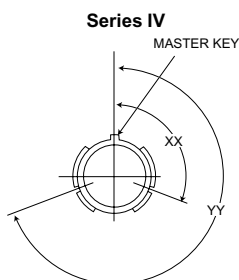

Front face of receptacle shown. Polarizing keys are external.

Key Arrangements	XX	YY
N	110°	250°
A	100°	260°
B	90°	270°
C	80°	280°
D	70°	290°

See page 131 for Series I, II and III polarization.



TDPX filter connectors are used primarily on commercial and military aircraft for radio and instrumentation equipment and are available in single thru four gang version with standard ARINC shells and polarizing posts. They are intermateable with the standard DPX connectors and available in 9 contact arrangements.

Meets applicable portions of MIL-Spec.

Note: The TDPX replaces the obsolete DPXJ Series

Performance and Material Specifications

MATERIALS AND FINISHES

Description	Material	Finish
Shell	Aluminum alloy	Cadmium plate (yellow chromate)
Contacts	Copper alloy	Gold over suitable underplate
Insulator	High grade plastic	none
Interfacial and Peripheral Seals	Neoprene rubber	none
Ground Plane	Beryllium copper	Silver plate
Polarizing Posts	Stainless steel	Passivate

ELECTRICAL

Contacts Size	20 & 22	20, 16 & 22	16			
Available Filter	Low Freq.	Mid Freq.	Std. Freq.	High Freq.	Low Freq.	
Catalog Reference	L	M	T	H	L	
Voltage Rating	200 VDC - 120 VAC rms 400 Hz					
Current Rating (Amp DC)	5 amp	7.5 amp - size #20, 20 amp - size #16	20 amp			
Insulation Resistance, 2 min. electrification time max. at 25° C and 100 VDC	5,000 megohms minimum @ 100 VDC					
DWV, sea level, with 500 microamps max. charge/discharge current	300 VDC	500 VDC	500 VDC			
Capacitance at 1 KHz, 0.1 V rms picofarads	32,000	8,000	2,300	850	32,000	
	45,000	12,000	5,000	1,300	45,000	
Attenuation per MIL-STD-220 at 25° C with no applied voltage or current.	Freq. MHz		Attenuation (dB)			
	0.1	2 min.	-	-	-	2 min.
	1	15 min.	2 min.	-	-	15 min.
	2	20 min.	5 min.	2 min.	-	20 min.
	10	35 min.	20 min.	12 min.	2 min.	35 min.
	100	60 min.	55 min.	50 min.	30 min.	50 min.
500 to 10,000	65 min.	60 min.	55 min.	50 min.	50 min.	
Filter Type	Pi	Pi	Pi	Pi	Pi	

†=Check Factory for availability of Size 22 "T" filters.

How to Order - Single Gang

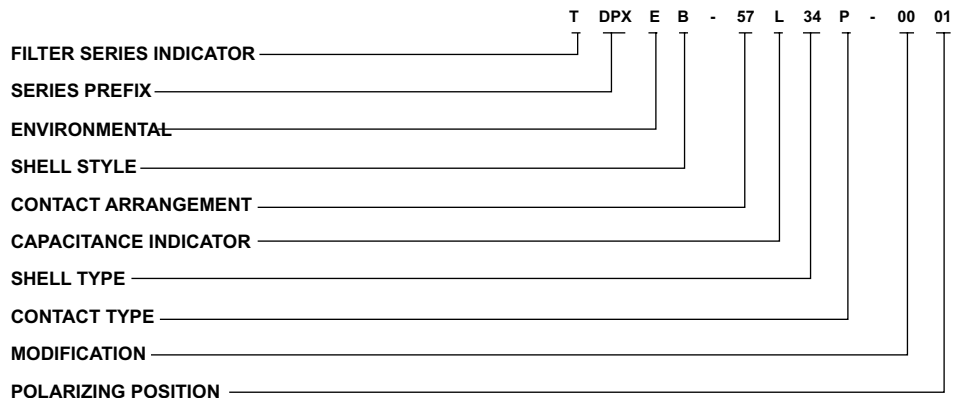

FILTER SERIES INDICATOR

T - Transverse Monolith

SERIES PREFIX

Single gang DPX

ENVIRONMENTAL

E - For interfacial (pin)
Delete for standard

SHELL STYLE

B - Polarized ARINC B shell (preferred)
D - DPXA flange (less polarizing posts)

CONTACT ARRANGEMENT

See page 318.

CAPACITANCE INDICATOR

L - Low Frequency
M - Mid Frequency
T - Standard Frequency
Note: Use of "T" omitted in past nomenclature.
H - High Frequency
N - No filters this gang. Standard DPX insert assembly.

SHELL TYPE

33 - Male (plug)
34 - Female (receptacle)

CONTACT TYPE

P-Pin; S-Socket

MODIFICATION

TDPXD
None
TDPXB
03 - Mounting holes countersunk 100' to .230 (5.84) dia.
23 - With floating eyelets.
Consult factory.

POLARIZING POSITION

See pages 67 - 68.

How to Order - Multiple Gang

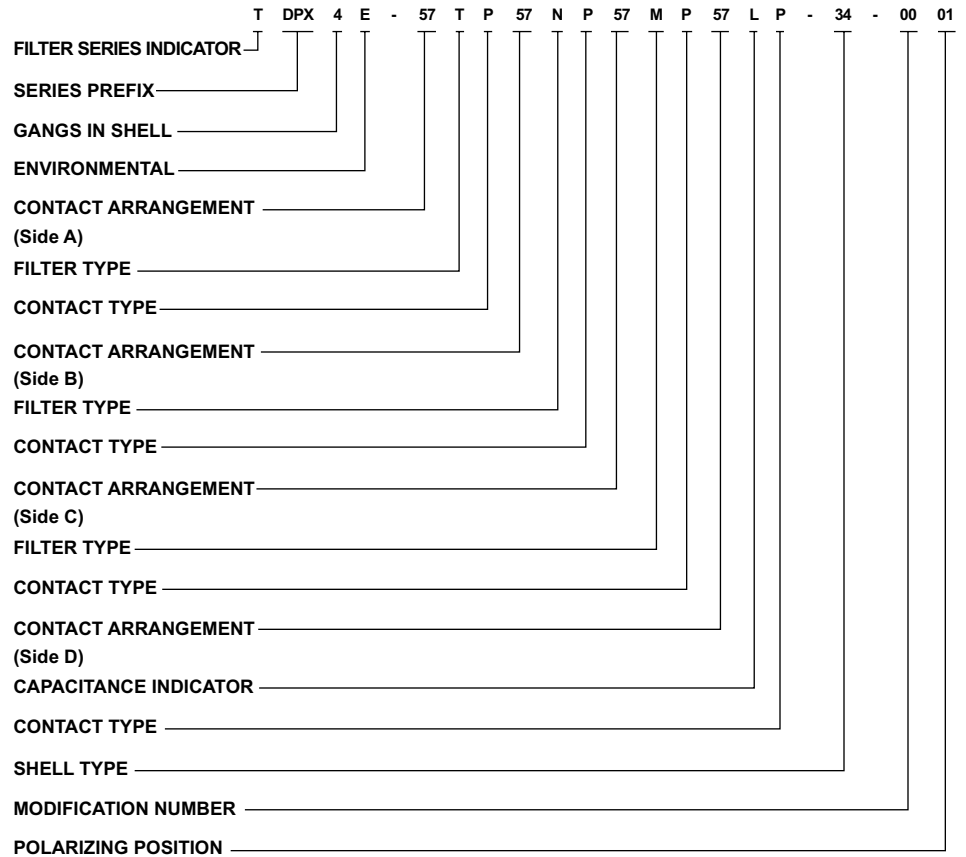

FILTER SERIES INDICATOR

T - Transverse Monolith

SERIES PREFIX

DPX - DPX series with solder termination.

GANGS IN SHELL

2, 3, and 4 gang

ENVIRONMENTAL

E - For interfacial (pin)
Delete for standard.

CONTACT ARRANGEMENT

See page 31 for applicable arrangements. Please specify each arrangement number as indicated in ordering nomenclature for 2, 3, or 4 gang.

CAPACITANCE INDICATOR (Each gang, as desired)*

L - Low Frequency

M - Mid Frequency

T - Standard Frequency

Note: Use of "T" omitted in past nomenclature

H - High Frequency

N - No filter this gang. Standard DPX insert assembly.

CONTACT TYPE

P for pin; S for socket. Designation follows each arrangement as ordered for 2, 3, or 4 gang versions. (Printed circuit contact/termination is available. Consult factory for specifications.)

SHELL TYPE

33B for male (ARINC B)

34B for female (ARINC B)

33 for male

34 for female

Note: ARINC B specified for DPX2 only.

POLARIZING POSITION (see pages 67-68)

The last two digits in the four-digit dash number refer to the polarizing post position. When the last two digits are omitted, the polarizing posts will be assembled in position 01, but the position number is not stamped on the connector. This allows the customer to position the posts themselves and then stamp the appropriate number on the shell. If the last two digits are 00, the polarizing posts are deleted.

MODIFICATION NUMBERS

- 0001 indicates standard design for all styles.

TDPX2-33B:

- 0301 - Mounting holes .120 dia.
Countersunk 100° to .230 dia.

TDPX2-34:

- 0101 - With #4-40 clinch nuts in mounting holes.

TDPX3-34:

- 0101 - With 6 #4-40 clinch nuts in mounting holes.

TDPX4-34:

- 0101 - With 10 #4-40 clinch nuts in mounting holes.

Contact Arrangements

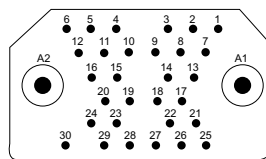

32C2
30 #20, 2 coax

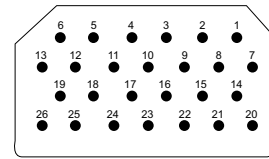

26
26 #16

Arrangement No.
No. of Contacts & Wire Size

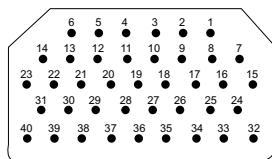

40
40 #20

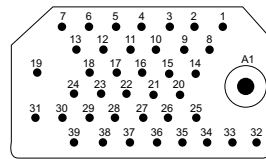

40C1
39 #20, 1 coax

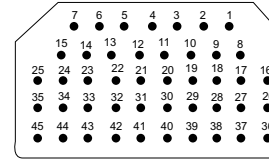

45
45 #20

Arrangement No.
No. of Contacts & Wire Size

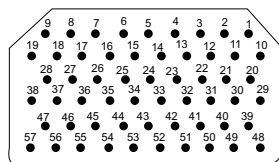

57
57 #20

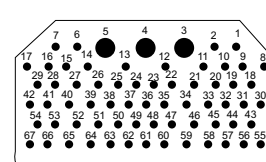

67
64 #20, 3 #16

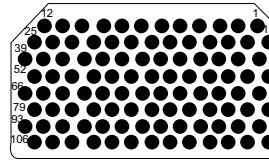

106*
106 #22

Arrangement No.
No. of Contacts & Wire Size

NOTE: Consult factory for part numbers for special combinations of filter, group contacts and power contacts, and for availability of filter socket contacts, for each contact arrangement.

Contacts - Pin and Socket

Standard Contact Terminations

Finish: Gold plate per MIL-G-45204, Type 1, Class 1, over nickel plate per QQ-N-290.

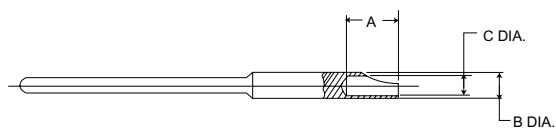

Pin/Solder Pot

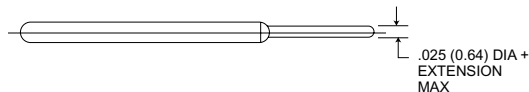

Pin/Printed Circuit

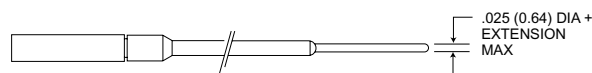

Socket/Printed Circuit

Contact Size	A	B	C	PC Tail Extension Max.
20	.125 (3.18)	.065 (1.65)	.048 (1.22)	.200 (5.08), .285 (7.24), .375 (9.52)
	.110 (2.79)	.061 (1.55)	.043 (1.09)	
16	.170 (4.32)	.103 (2.62)	.078 (1.98)	.200 (5.08), .285 (7.24), .375 (9.52)
	.150 (3.81)	.097 (2.46)	.069 (1.75)	
22	.115 (2.92)	.005 (1.40)	.040 (1.02)	.200 (5.08), .285 (7.24), .375 (9.52)
	.095 (2.41)	.051 (1.30)	.036 (0.91)	

Single Gang

TDPXB

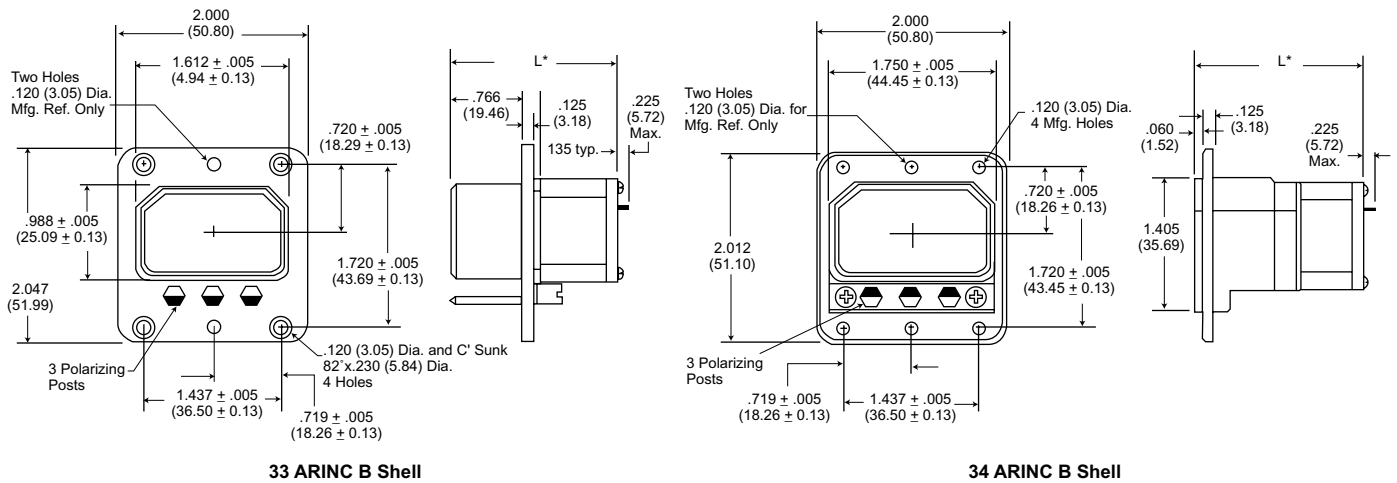

* This length varies between the limits of 1.750 (44.45) and 1.437 (36.25) depending on the particular construction as determined by contact arrangement.

TDPXD

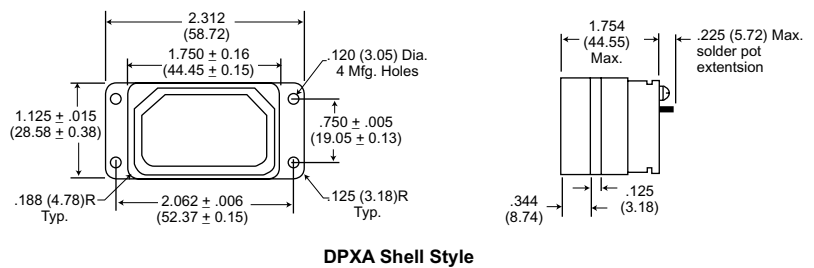

Two Gang

TDPX2

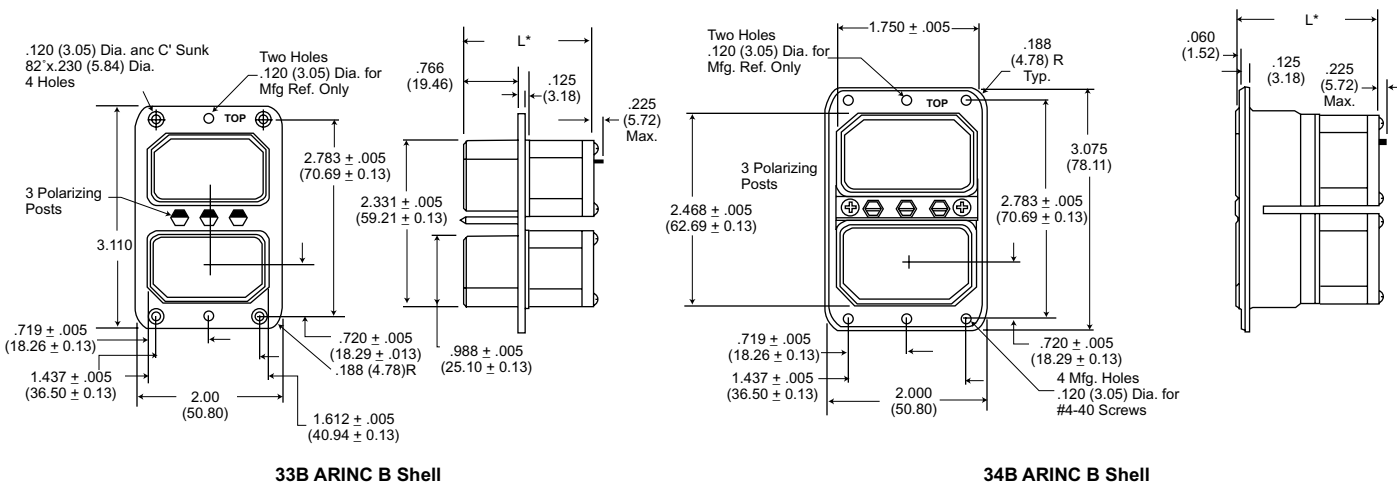

* This length varies between the limits of 1.750 (44.45) and 1.437 (36.25) depending on the particular construction as determined by contact arrangement.

Three Gang

TDPX3

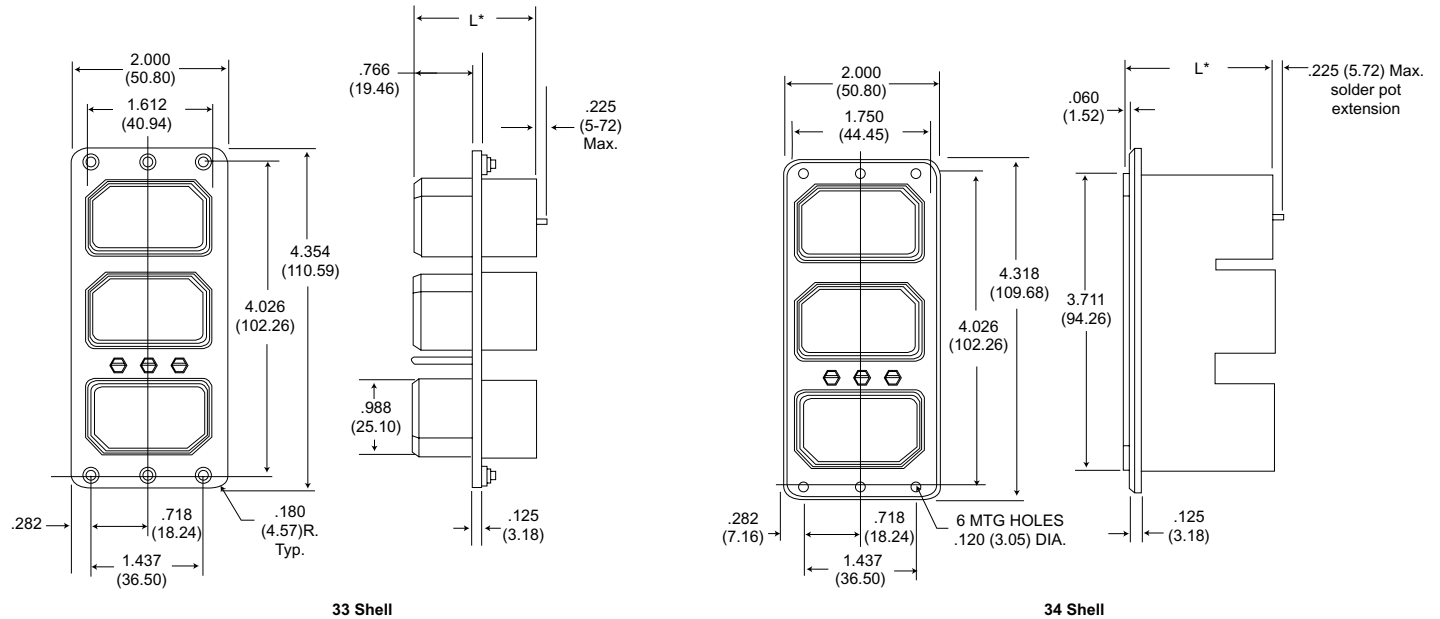

* This length varies between the limits of 1.750 an 1.437 depending upon particular construction as determined by contact arrangement.

Four Gang

TDPX4

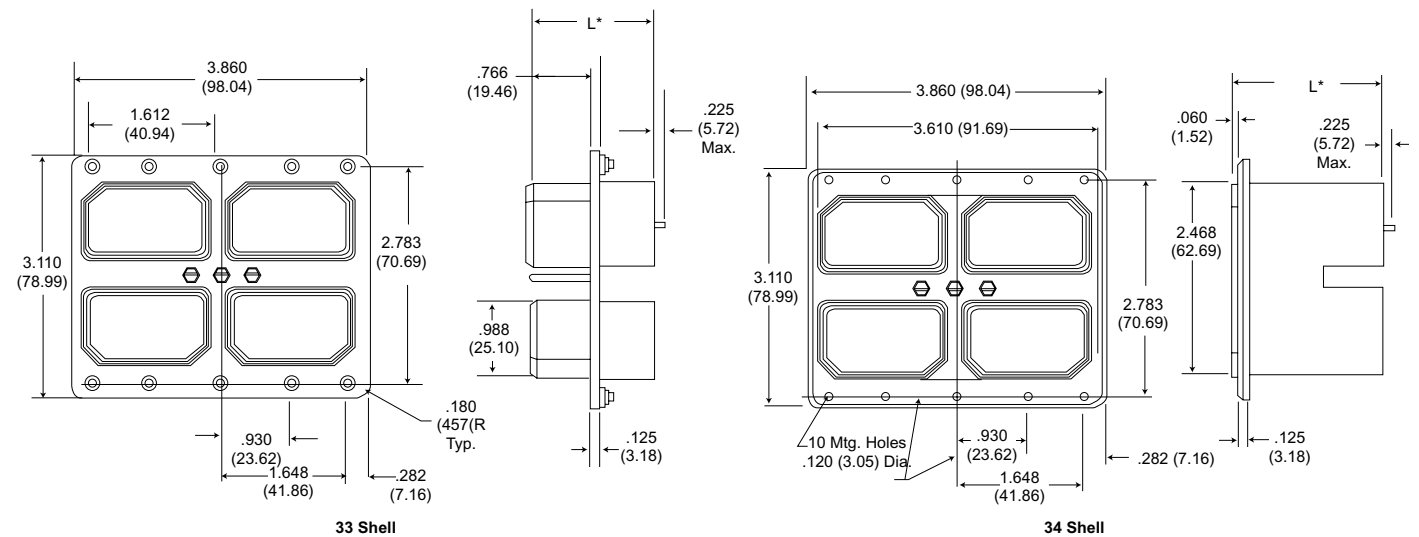

* This length varies between the limits of 44.45 an 36.25 depending upon particular construction as determined by contact arrangement.

Panel Cutouts - Pages 69-71.



TBKAD/E connectors represent a major milestone in presenting a new rack and panel connector for support of the air transportation market.

Several important design concerns have been addressed and solved in this series. High mating forces of pluggable modules in a rack have been reduced by approximately two-thirds. Filter adaptations include either single module or tandem (dual) module with crimp piggyback rear release contacts.

In the ARINC 600 connector series, size 22 contacts are the only size that utilize the Pos-Align Connector Construction feature. The hooded socket extends from its receptacle insulator in the filter design.

- Low insertion force contacts.
- Non-environmental versions.
- Polarizing posts that are removable from the mating face.
- Field replaceable inserts for size 22 and power contacts.
- Field replaceable filter modules with size 22 contacts.
- Up to 800 size 22 contacts in one connector.
- Crimp piggy back and pi contacts for filter module.
- Uses standard DPX crimp, insertion/extraction tooling.
- Waveguide connections available.

How to Order

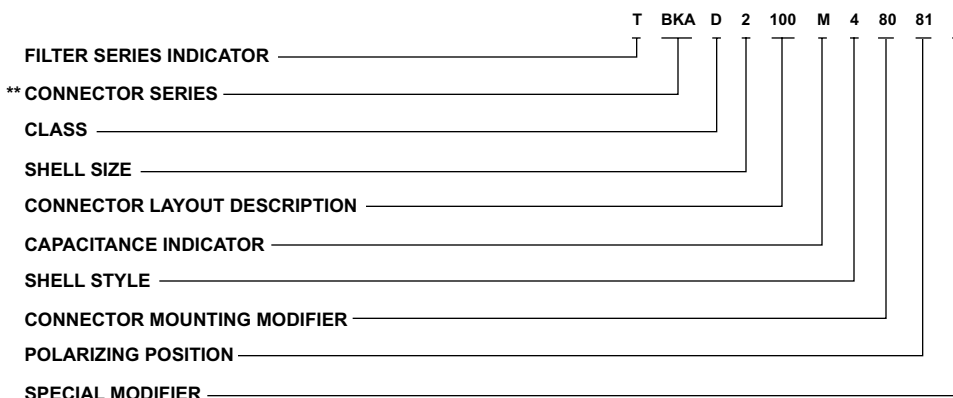

FILTER SERIES INDICATOR

T - Transverse Monolith

CONNECTOR SERIES

BKA (Per ARINC 600)

* * Consult factory for availability.

CLASS

D - Non-environmental

(rear release, crimp contacts)

CONNECTOR LAYOUT DESCRIPTION

Three digit number contained within the shell layout indicates total number of contacts available

Connector Layout	Shell Size	Shell Cavity Identification					
		A	B	C	D	E	F
-060	1	-	60	-	-	-	-
-A060	1	60	-	-	-	-	-
-120	1	60	60	-	-	-	-
-100	2	-	-	100	-	-	-
-300	2	150	150	-	-	-	-
-400	2	150	150	100	-	-	-
-600	3	150	150	-	150	150	-
-800	3	150	150	100	150	150	100

SHELL SIZE

1-Max. contact capacity - 125

2-Max. contact capacity - 400

3-Max. contact capacity - 800

CAPACITANCE INDICATOR

L - 32,000-45,000 PF

M - 8,000-12,000 PF

T - 3,300-5,000 PF

H -850-1,300 PF

SHELL STYLE

3-Plug (rack side) consult factory

4-Receptacle (box side)

CONNECTOR MOUNTING MODIFIER

00-Standard design .148 dia. holes

01-With #6-32 ESMA (#12 NCFMA2-62) clinch nuts

Connector Size	# of Clinch Nuts Receptacle
1	4
2	6
3	10

02-Size 1 receptacle only - less 3 printed circuit board mounting lugs

03-With #4-40 ESMA (#22 NCFMA2-40) clinch nuts

Connector Size	# of Clinch Nuts Receptacle
1	4
2	6
3	10

08-Size 2 and 3 receptacle only-with #4-40 ESMA (#22 NCFMA2-40) clinch nuts (all mounting holes)

09-Size 2 and 3 receptacle only-with #6-32 ESMA (#12 NCFMA2062) clinch nuts (all mounting holes)

23-with floating eyelets (.048 min. radial float) 4 corner holes per connector

Consult factory if other modifications are required.

POLARIZING POSITION

01 thru 99 (per ARINC 600)

Blank-Polarizing posts or keys not installed but supplied with connector

SPECIAL MODIFIER

Consult factory

Performance and Material Specifications

MATERIALS AND FINISHES		BKAD	SPECIFICATIONS
Shell	Material	Aluminum Alloy	QQ-A-591/A380
	Finish	Clear chromate over cadmium	QQ-P-416
Insulator	Material	Thermoplastic	N/A
	Material	Copper alloy	AA-C-533
Contacts	Finish	Gold over nickel	
	Termination	Crimp	N/A
	Material	Copper alloy	
Ground Spring	Finish	Sliver	

ELECTRICAL DATA (Size #16, Size #20 and Size #22)

Filter Description	Low Freq.	Mid Freq.	Std Freq.	High Freq.
Catalog Indicator	L	M	T	H
Voltage Rating	200 VDC-120 VAC rms 400 Hz			
Current Rating (amp DC)	15 amp size 16, 7.5 size 20, 5.0 amp size 22			
Insulation Resistance, 2 min. electrification time max. at 25°C	5,000 megohms min. @ 100 VDC			
DWV, sea level, with 500 microamps max. charge/discharge	300V DC size 22 500V DC size 16 & 20	500VDC	500VDC	500VDC
Capacitance at 1 KHz 0.1 V rms Picofarads	32000	8000	3300	850
	45000	12000	5000	1300
Attenuation per MIL-STD-220 @ 25°C with no applied voltage or current	Freq. MHz			
	0.1	2 min.	-	-
	1.0	10 min.	2 min.	-
	2	16 min.	7 min.	2 min.
	10	40 min.	18 min.	8 min.
	100	60 min.	55 min.	45 min.
	500 to 1000	65 min.	60 min.	55 min.
Filter Type/Construction	Pi	Pi	Pi	Pi

Consult factory for higher or mixed attenuation values and higher voltage ratings.

Contact Arrangements (Receptacle-Engaging Face Shown)

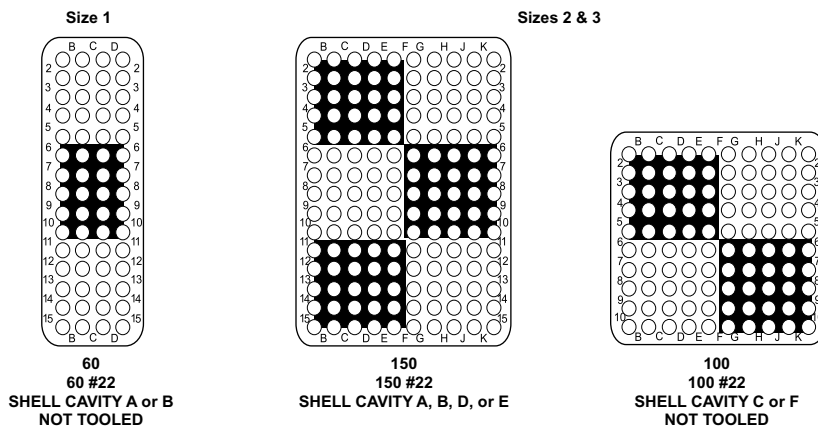

Size 1 Receptacle

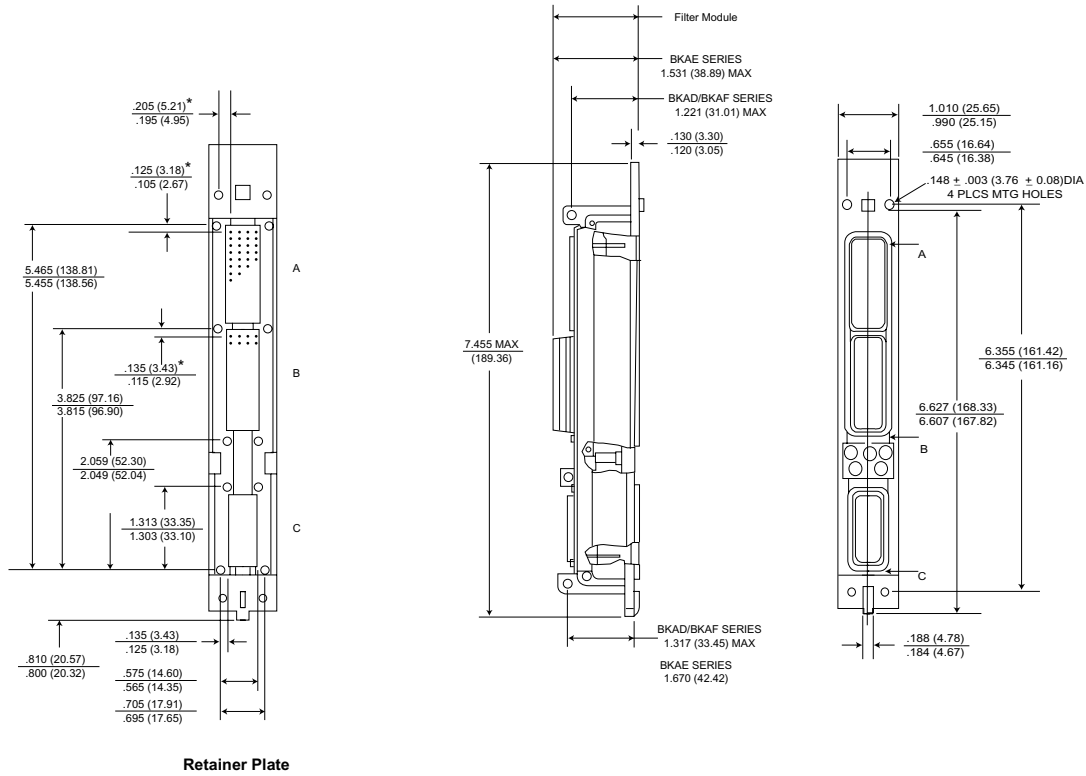

* This dimension indicates distance from centerline of retaining screw to the centerline of first contact cavity.

Size 2 Receptacle

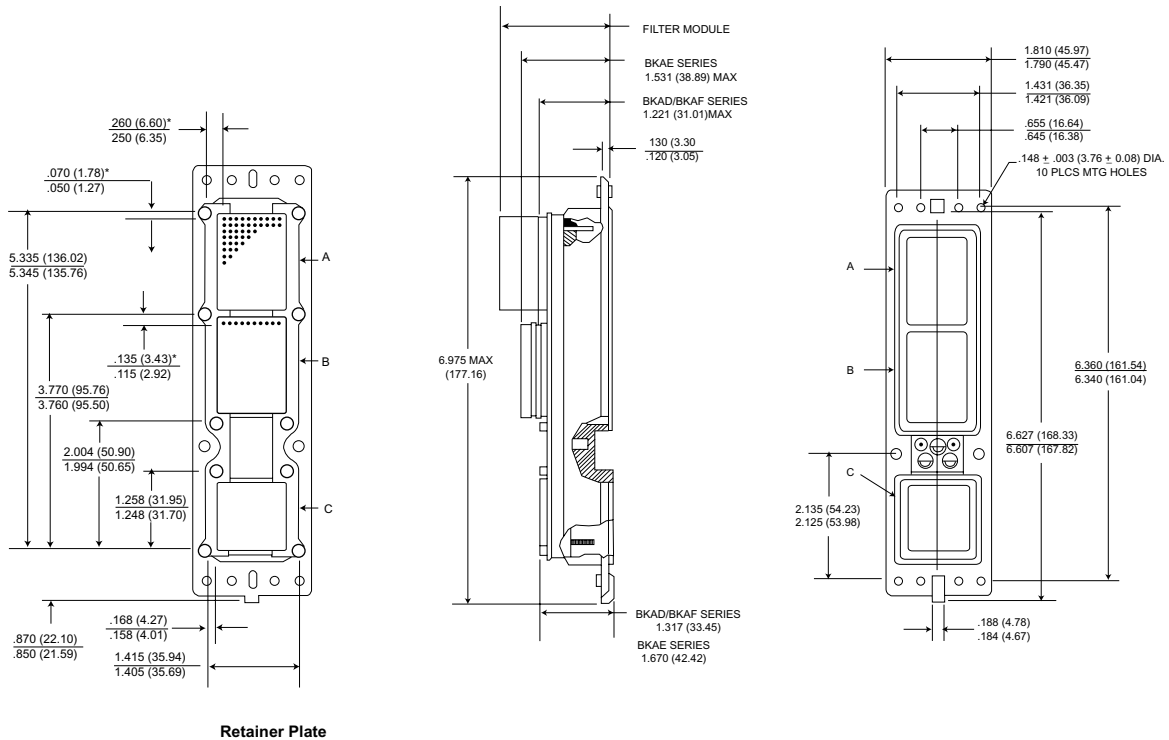

* This dimension indicates distance from centerline of retaining screw to the centerline of first contact cavity.

Size 3 Receptacle

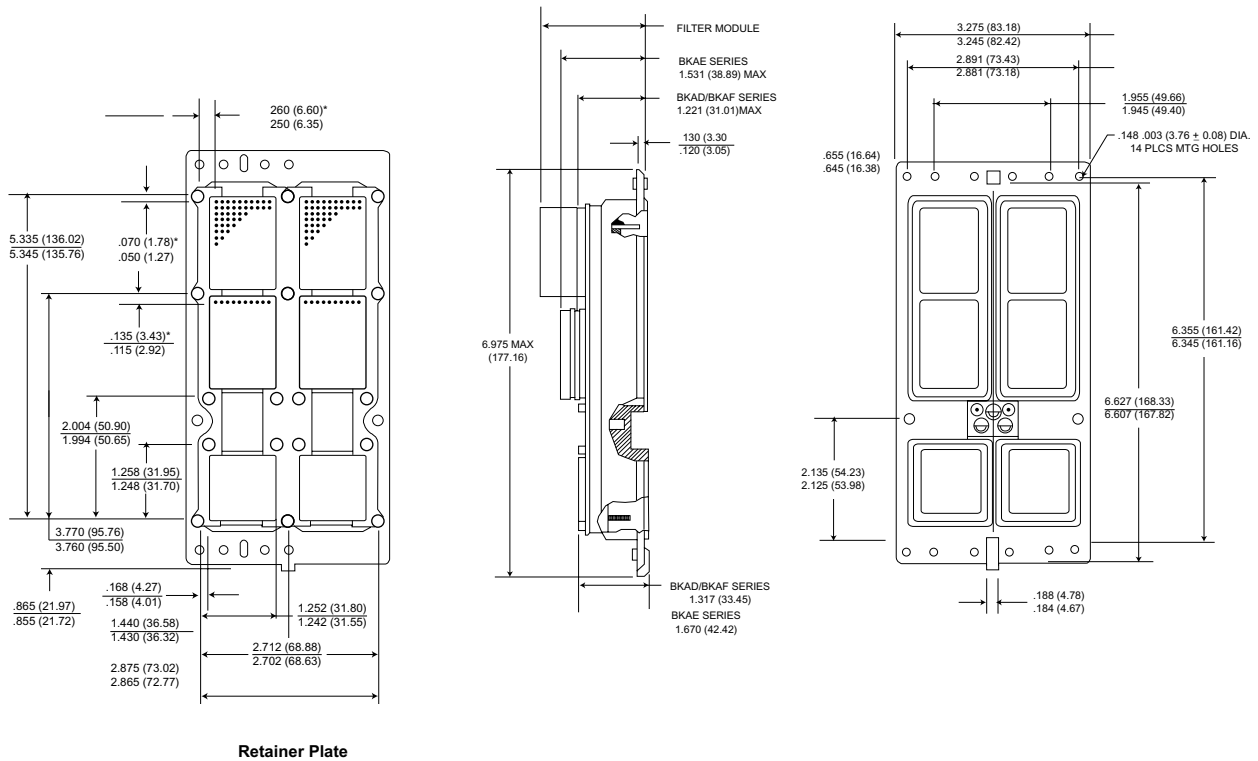

* This dimension indicates distance from centerline of retaining screw to the centerline of first contact cavity.

Panel Cutouts

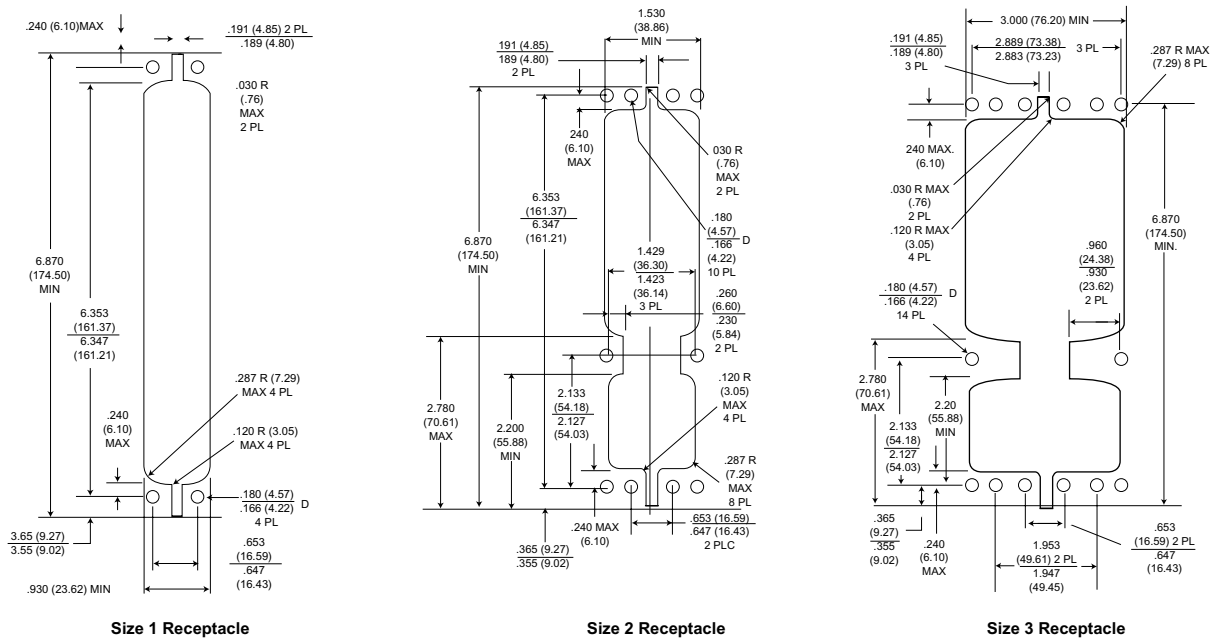

Meet applicable portions of MIL-Specs.



ITT Cannon has developed a new connector concept to satisfy the need to protect today's sophisticated electronic circuitry from electromagnetic pulses (EMP) generated by lightning, system transients, nuclear blast, or static discharges.

Transient suppression, built into the ITT Cannon PSP (Phoenix Surge Protector) connectors, is accomplished by the switching action of a silicon p-n junction device mounted on the connector contact which switches from a steady state standby condition into the avalanche condition. This device conducts when the voltage surge reaches a value sufficient to cause avalanche multiplication. The

transient is shunted through the silicon device to the connector housing. Response time of the transient absorbing suppressor clamping action is better than 1×10^{-9} seconds with a peak pulse power dissipation of 500-1500 watts at 25°C depending on contact size.

Addition of the EMP suppression circuitry does not require changes in the connector diameter or interface dimensions.

The PSP connector is offered in MIL-C-38999 Series I, II, III, and IV, Mil-C-81659 (ARINC 404) and ARINC 600. All versions can be provided with EMP or EMP/EMI combinations.



Standard Data

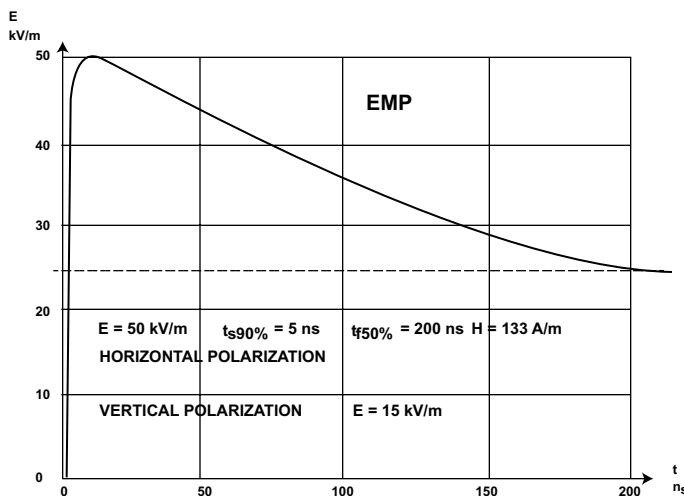

LIGHTNING

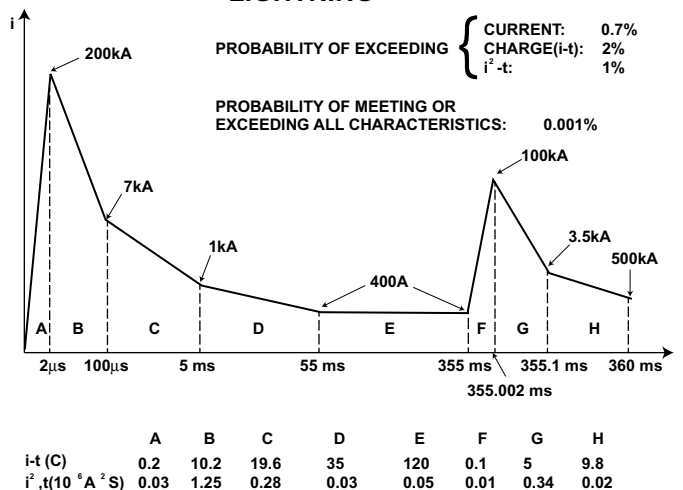

Diode Breakdown Voltage

Typical electrical values for the two breakdown voltage extremes are as follows:

Breakdown Voltage (BR)		Test Current I_T	Rated Stand Off Voltage V_{WM}	Max. Reverse Leakage Current $I_D @ V_{WM}$	Max. Peak Reverse Voltage $V_C \text{ Max. @ } I_{PP}$	Max. Peak Pulse Current I_{PP}	Max. Temp. Coefficient of V_{BR} (TA) -55°C to 100°C
Min.	Max.						
V_{DC}	V_{DC}	mA DC	V	$\mu\text{A DC}$	V	A	%/°C
6.4	7.3	10.0	5.0	600.0	9.6	52.0	.057
189.0	209.0	1.0	170.0	1.0	275.0	1.8	.108

Note: All values are based on an 8 x 20 μs (microsecond) wave form.

Contacts

Diode contacts are available in 500, 1,000 and 1,500 watts with breakdown voltage (VBR) values of 6.8 to 200 voltage D.C. The contacts can be provided in a positive, negative, or bi-junction polarity as required by operating line voltage.

How to Order PSP to MIL-C-38999

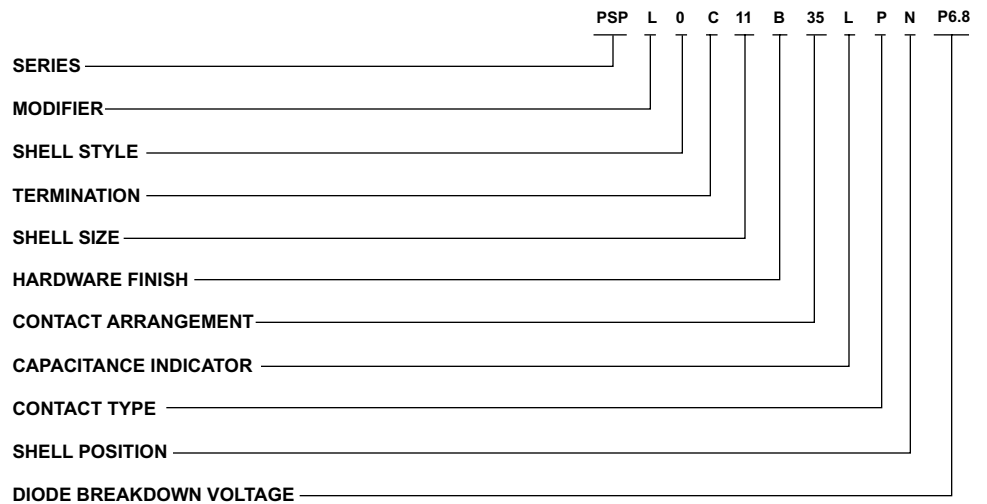

SERIES PREFIX:

PSP - Phoenix Surge Protector

MODIFIER: (Receptacle Only)

- L - Series I Long Scoop Proof Shell
- S - Series II Short Shell
- A - Series III Triple Start Thread
- B - Series IV Breech Lock

SHELL STYLE:

- 0 - Wall Mounting (Front Panel Mount)
- 2 - Box Mounting (Front Panel Mount)
- 3 - Wall Mounting (Back Panel Mount)
- 5 - Box Mounting (Back Panel Mount)
- 7 - Jam Nut

TERMINATION:

- C - Crimp Piggyback
- S - Solder Pot
- P - P.C. Tail

SHELL SIZE:

- Series I, III, and IV - 9, 11, 13, 15, 17, 19, 21, 23 and 25
- Series II - 8, 10, 12, 14, 16, 18, 20, 22 and 24

HARDWARE FINISH:

- B - Olive drab cadmium over nickel plate
- G - Gold
- N - Electroless nickel

CONTACT ARRANGEMENT

See chart below or page 315.

CAPACITANCE INDICATOR*

- L - 32,000-45,000 PF
- M - 8,000-12,000 PF
- T - 3,300 - 5,000 PF
- H - 850-1,300 PF

CONTACT TYPE

- P - Pin
- S - Socket

SHELL POSITION

- N - (Normal), A, B, C, D

DIODE BREAKDOWN VOLTAGE

- List actual breakdown voltage per pin preceded by:
- P - Positive (+)
- M - Minus (-)
- B - Bipolar (±)

LAYOUTS:

8/9-35	16/17-35
10/11-5	18/19-32
10/11-98	18/19-35
10/11-35	20/21-41
12/13-8	20/21-35
12/13-35	22/23-55
14/15-18	22/23-35
14/15-35	24/25-61
16/17-26	24/25-35

Hermetic Connectors

Users around the world have found that ITT Cannon hermetic connectors function reliably under extreme environmental conditions. Hermetic connectors are impervious to most liquids and gases, including acids, alkalis, oils, gasoline, jet fuel and hydraulic fluids. They can take shock loads as high as 100 g's with no loss of hermeticity, and can take extremes of both heat and cold with no loss of performance.

Manufacturing Expertise

Cannon compression glass seals are strong. A 50,000 psi compression stress generates a sealing force that can withstand up to 10,000 psi differential pressure (pressure varies with connector type). Since it is independent of adhesion, the seal has a temperature capability of -260° to +600° Fahrenheit. The seal has high radiation resistance and a leak rate of less than 10^{-7} cc per second.

All Cannon hermetic connectors are 100% tested after fabrication. A stringent examination ensures that all military specifications are met. The product is tested for leak performance, dielectric withstanding voltage and insulation resistance.

Custom Design Capabilities

Custom hermetic connectors can be manufactured to meet special requirements. Hermetic connectors have been developed to withstand exposure to propellants, high pressure and high temperature conditions for missiles, "sub-safe" connectors for penetration feed-thru on ships and submarines, connectors for aircraft engines, and space applications.

KPTH/PVAH - Miniature Circular MIL-C-26482



ITT Cannon hermetically-sealed KPTH and PVAH (MIL-C-26482, Series I and II) connectors are designed for those applications and environments that require delicate mechanisms to be protected from variations in atmospheric pressure (leakage is less than $0.01 \text{ micron ft}^3/\text{hr}$ [10^{-7} cc/sec.])

The receptacles are available with pin contacts only and in three shell styles; box mounting KPT02H, solder mounting KPT01H, and jam nut KPT07H for Series I; box mounting PVA0, solder mounting PVA3, and jam nut PVA7 for series II. Contact arrangements are tooled in a full leak-free compression glass web.

KJLY, KJY, KJAY - Miniature Circular MIL-C-38999 Series I, II, III



Cannon's KJLY/KJY/KJAY miniature circular connectors are hermetically sealed and designed to meet the critical performance and design requirements of MIL-C-38999 (leakage is less than $0.01 \text{ micron ft}^3/\text{hour}$ [10^{-7} cc/sec.]). Engineered for high density circuitry capabilities, these connectors are designed to operate at temperatures ranging from -85°F to +392°F (-65°C to +200°C); solder mounts 302°F (150°C). They are readily adaptable

to both commercial and space age requirements where size, weight, scoop proof/low-profile design and high reliability are key factors. KJLY/KJLY/KJAY connectors are offered in nine shell sizes. A total of 53 contact arrangements are available that will accommodate from 3 to 128 contacts using AWG wire sizes 16 through 28. Contacts are of nickel/iron alloy with gold plated finish.

BFH/TBFH - Standard Circular MIL-C-5015

TBFH-100/TBFH-200



The BFH is a hermetically sealed version of the BFR bulkhead fitting.

The TBFH-100 is a jam nut-mounted, thru-bulkhead receptacle for panel thicknesses of .187" thru .312". Sealing against the bulkhead is accomplished by an O ring seal.

The TBFH-200 is similar to the TBFH-100 with a longer overall length for panel thicknesses of .375" thru .750"

The TBFH-110 is the hermetically sealed version of the TBF thru-bulkhead receptacle. It is flange mounted and mates with 3106, 3107 and 3108 plugs. Contacts are sealed to achieve hermeticity preventing air leakage in excess of one micron cubic foot per hour (10^{-7} cc/sec.) at a pressure differential of one atmosphere. Receptacles with leakage rate of 0.01 micron cubic foot per hour (10^{-7} cc/sec.), and lower, are also available.

TBFH-110



Contacts and shells are steel. Standard finish is clear chromate over cadmium. Other finishes are available for high temperature and special applications.

Hermetic Connectors

GS - Standard Circular MIL-C-5015

GS02-00
Flangeless Receptacle



GS02-11
Square Flange Receptacle



GS02-25
Circular Flange Receptacle



ITT Cannon hermetically sealed GS connectors are designed for applications where a vacuum, inert gas, or a constant or controlled pressure is required to eliminate adverse effects created by atmospheric changes.

GS connectors are hermetically sealed with compression glass to prevent air leakage in excess of 1×10^{-5} standard cubic centimeters per second at

1 atmosphere. Standard hermetic receptacles are available with either solder pot or eyelet contacts. Tube-type contacts for special solid wire feedthrough applications (thermocouple) are also available.

The standard material for shells and contacts is steel with tin over cadmium finish on GS02 connectors. Other materials and finishes can be supplied to meet any specific application.

GS connectors are manufactured to ITT Cannon specifications and meet the Instrument Service Voltage Rating of MIL-C-5015. Connectors with higher voltage ratings are also available upon request. Salt spray, shock and vibration requirements, and mating dimensions all approximate the requirements of MIL-C-5015 and can be contractually approved for military applications.

D*H - D Subminiature MIL-C-24308



D*H hermetically sealed connectors are designed to meet environmental conditions of extreme pressure differential. These connectors are part of the ITT Cannon D subminiature series and are qualified to MIL-C-24308. The hermetic seal prevents leakage and subsequent accumulation of corrosive moisture behind the connector. There are five basic shell sizes in both standard and thru-bulkhead designs which can accommodate from 9 to 50 contacts. Polarization is achieved by the keystone shape of the shell, a feature of all connectors within the D Subminiature series.

Locking devices are available for all shell sizes. Size 20 pin contacts are standard and have a current rating of 5 amps. † Eyelet, solder pot, and feed-thru contact terminations are available and can accommodate stranded wire up to #20 AWG. Operating temperatures range from -54°C to 125°C (-65°F to 257°F).

Your inquiries are invited regarding custom brazed component variations and special modifications.

†Military rating of #20 contacts or wires is 1.5 mps average, and 7.5 amps maximum.

MDMH - Microminiature MIL-C-83513



Contact Layout: 9, 15, 21, 25, 31, 37, 51, 100

Hermetic Micro Seris Mates with MDM Rectangulars

MDMH Connectors are ideal for applications requiring an extremely small, hermetically sealed connector having a higher contact density than traditional rectangular connectors. The MDMH receptacle has from 9 to 100 socket contacts on .050" (1.27mm) centers and mates with ITT Cannon MICRO Division's MDM Series having reliable, proven, "Twist Pin" contacts. The connector utilizes size 24 contacts that are compression glass-sealed through a steel shell and into a "front-end" insulator. AN interfacial seal provides environmental protection when mated. MDMH receptacles are soldered to a chassis or container providing a completely leak-proof unit.

Features:

- Hermetically sealed connector designed for those applications where a vacuum, inert gas, or a constant controlled pressure are required to eliminate adverse effects created by atmospheric changes.
- Steel shells to provide greater strength, prevent chipping, cracking or breaking, offer electromagnetic (EMI) and RFI shielding.
- Silicone elastomer compression interfacial seal to provide a moisture and humidity seal between each contact and between contacts and shell.

STANDARD MATERIALS AND FINISHES

Shell	Mild steel, nickel plated
Insulator	Glass-filled diallyl phthalate per MIL-M-14 type SDGF, or polyester per MIL-M-24519, or glass-filled epoxy
Contacts	Copper alloy, gold plated sockets on mild steel, gold plated pins Solder pots - mild steel, gold plated
Hermetic Seal	Compression glass
Leak Rate	1 micron cubic FT/Hr max (1.04×10^{-5} cc/sec at 1 ATM, pressure differential)

ELECTRICAL DATA

No. of Contacts	9 thru 100
Dielectric Withstanding Voltage	150 VAC
Insulation Resistance	5,000 Meg. Ohms Min.
Wire Size	#26 thru #30 AWG
Contact Termination	Solder pot

MECHANICAL FEATURES

Size or length	8 sizes
Service Class	Hermetically sealed
Coupling	Friction/jacks
Polarization	Keystone-shaped shells
Contact Spacing	.050 (1.27 mm) centers
Shell Style	Receptacle, solder mounted

Battery Connectors

Battery Connectors are designed to eliminate the need for separate starting batteries on individual units of power driven equipment. The receptacle may be mounted on each unit and wired to the starting motor. While the plug with cable and battery, may be carried on a tractor, truck, or other portable or stationary source. This eliminates the need for batteries on each unit of equipment and save costly maintenance and replacement.

In addition, these connectors are used to connect auxiliary power equipment to electrical systems. This preserves the charge of aircraft batteries for any in-flight function.



Mating Guide

No. of Contacts	Current Rating (Cont)	Plugs			Receptacles		
		Part Number	Recommended Wire Size	Cable Entry or Terminal Dimension	Part Number	Recommended Wire Size	Cable Entry or Terminal Dimension
2	250a	GB-3-21CFS	#3/0	5/8" dia.	GB-3-34CDS	#1/0	3/8-24UNF-2A
1	40a		#10	1/8" dia.		#10	10-32NF-2A
		GB-3-21CF	#3/0	5/8" dia.			
			#10	1/8" dia.			
2	200a	CA2551C (017193-0015)	#1/0	3/4" dia.	CE9310-8	#2/0 #12	3/8-16UNF-2A 10-32NF-2A
1	35a		#12				
2	200a	CA2551C Model A (017193-0115)	#1/0	51/64" dia.			
1	35a		#12				
2	250a	CA2551D (017193-0008)	#2/0	3/4" dia.			
1	35a		#12				
2	250a	CA2551D Model A (017193-0108)	#2/0	15/16" dia.			
1	35a		#12				
2	400a	CA2551E (017193-0000)	#4/0	15/16" dia.			
1	40a		#10				
2	400a	CA2551E Model A (017193-0100)	#4/0	1-3/64" dia.			
1	40a		#10				
2	600a*	CA11751-1	#2/0	5/16-18UNC-2B	CA11749-1	#2/0	5/16-18UNC-2B
4	200a	CE9183-1	#1/0	27/32" dia.	CE9310-10	#1/0 #12	11/16
2	35a		#12				
4	200a	CE9183-4	#1/0	45/64" dia.			
2	35a		#12	1 entry, 5/8" dia.			
4	200a	CE9183-6	#1/0	27/32" dia.			
2	35a		#12	1 entry, 25/32" dia.			
1	250a	AA-BP	#2/0	5/16-18UNC-2B	AA-BR	#2/0	3/8-16UNC-2A
1	250a	C5-2	#2/0	5/16-18UNC-2B	C5-1	#2/0	5/16-18UNC-2A

* Amperage rating of 600 amp is based on a maximum of 2 hours continuous service or before temperature rise of 120°C over 25°C ambient is reached.

Receptacles

GB-3-34CDS

Shell:	Aluminum alloy-Cadmium plate
Insulation:	Phenolic
Weight:	1.031 lb.
Contact Data:	Copper alloy-Silver plate 2-250a - #1/0 wire • .375 (9.52)-24 T.P.I. Stud 1-40a - #10 wire • .313 (7.95) T.P.I. Stud Top contact insulated from shell; two lower contacts grounded to shell.

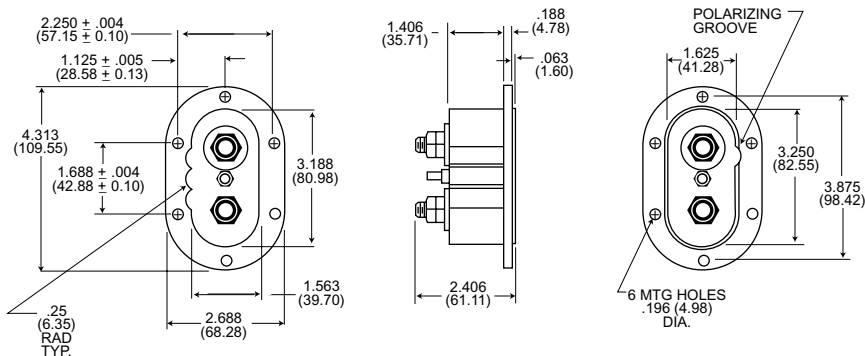

Battery Connectors

Plugs (Continued)

GB-3-21-CFS

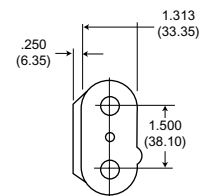
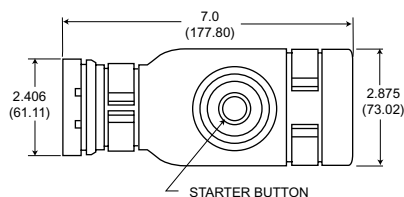

Shell:	Molded rubber
Clip:	Spring Steel•Cadmium plate
Weight:	1.116 lb.
Contact Data:	Copper alloy•Silver plate 2-250a- #3/0 wire•Cable entry .750 (19.05) 1-40a-#10 wire•Cable entry .266 (6.76)

GB-3-21-CF

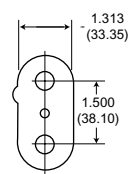
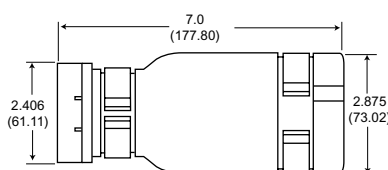

Shell:	Molded rubber
Wheel:	Spring Steel•Cadmium plate
Weight:	1.050 lb.
Contact Data:	Copper alloy•Silver plate 2-250a- #3/0 wire•Cable entry .750 (19.05) 1-40a-#10 wire•Cable entry .266 (6.76)

CA2551

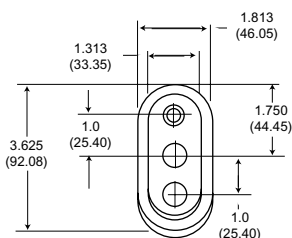
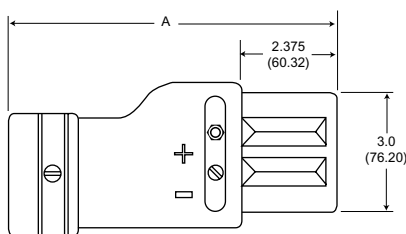

Shell:	Molded rubber					
Clip:	Spring steel•Cadmium plate					
Weight:	Consult factory					
Contact Data:	Copper alloy•Silver plate					
Type	Part Number	Number of Contacts	Wire Size	Current (Amps)	A	Cable Entry
CA2551C	017193-0015	2	#1/0	200	7.000 (177.80)	.750 (19.05)
		1	#12	35		
CA2551C	017193-0115	2	#1/0	200	8.125 (206.38)	.797 (20.24)
Model A		1	#12	35		
CA2551C	017193-1000	2	#1/0	200	8.125 (206.38)	.938 (23.83)
Model A		1	#12	35		
CA2551D	017193-0008	2	#2/0	250	7.000 (177.80)	.750 (19.05)
		1	#12	35		
CA2551D	017193-0108	2	#2/0	250	8.125 (206.38)	.938 (23.83)
Model A		1	#12	35		
CA2551E	017193-0000	2	#4/0	400	8.125 (206.38)	.938 (23.83)
		1	#10	40		
CA2551E	017193-0100	2	#4/0	400	8.125 (206.38)	1.047 (26.59)
Model A		1	#10	40		

Battery Connectors

Plugs (Continued)



CE9183

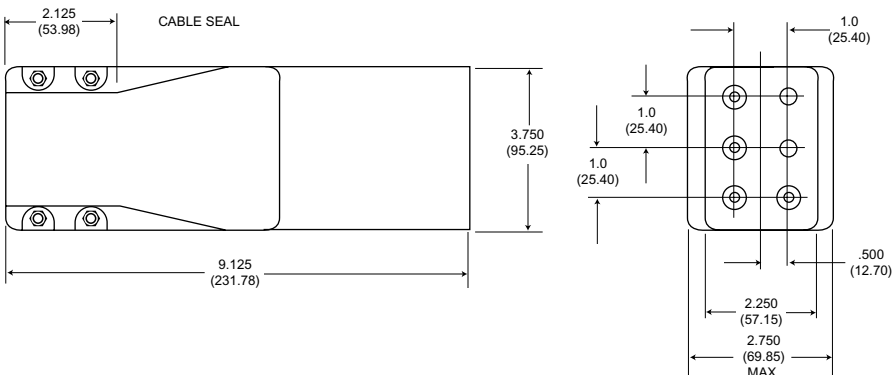

Insulation:	Rubber molded one-piece construction
Cable Seals:	Removable molded rubber
Power Contacts:	Removable snap in crimp or solder type
Small Contacts:	Molded into insulation with removable crimp or solder pots
Extraction Tool:	#317-8037-000 power contacts
Insertion Tool:	#317-8034-000 power contacts
Insertion Tool:	#317-8035-000 small contacts
Contacts:	Copper alloy, silver plate Brass, silver plate

Part Number	No. of Contacts	Wire Size	Current (Amps)	Cable Entry
CE9183-1	4	#1/0	200	.844 (21.44)
	2	#12	35	-
CE9183-4	4	#1/0	200	.703 (17.86)
	2	#12	35	1 entry .625 (15.88)
CE9183-6	4	#1/0	200	.844 (21.44)
	2	#12	35	1 entry .781 (19.84)

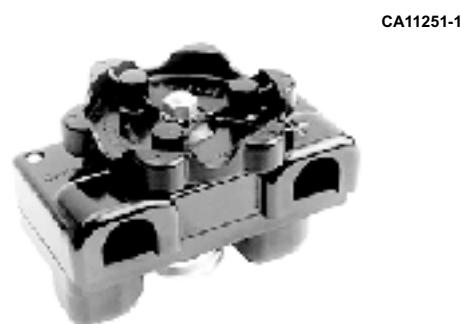

CA11251-1

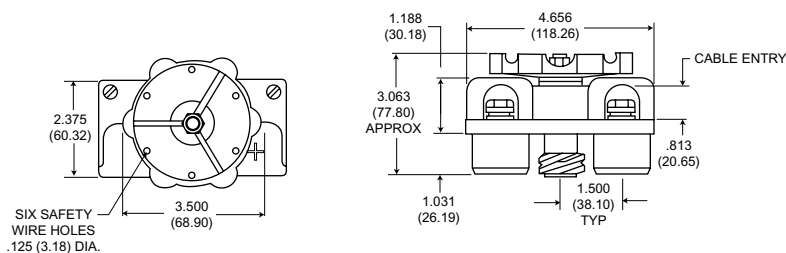

May be used on batteries conforming to MIL-B-6146.

Shell:	Molded phenolic
Wheel:	Aluminum alloy
Weight:	1.023 lb.
Contact Data:	Copper alloy 2-600a - #2/0 wire • Cable entry .813 (20.65)

Receptacles



CA11749-1

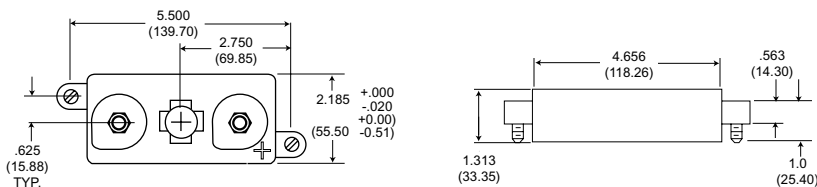

Shell:	Aluminum alloy • Black acid-proof lacquer finished
Weight:	.380 lb.
Contact Data:	Copper alloy • 2-600a • #2/0 wire Pin contacts screw on battery • 5/16-18 T.P.I.

Amperage rating of 600 amp is based on a maximum of 2 hours continuous service or before temp. rise of 120° C over 25° C ambient is reached.

High Reliability, Military D Subminiature, & Non-Magnetic/No-Outgas

Solder Cup



(See page 333)

Crimp



(See page 334-335)

Printed Circuit



(See page 336-338)

Performance and Material Specifications

MATERIALS AND FINISHES

	Standard		Military	
	Material	Finish	Material	Finish
Shell	Steel per ASTM A-620	Yellow chromate over cadmium QQ-P-416 Type II Class 2	Steel per ASTM A-620	Yellow chromate over cadmium QQ-P-416 Type II Class 2
Insulator	Diallyl phthalate glass-filled per MIL-M-14, type SDG-F, color green		Diallyl phthalate glass-filled per MIL-M-14, type SDG-F, color green	
Contact	Copper alloy	Gold over nickel	Copper Alloy Crimp Socket has stainless steel hood passivated.	Gold 50 microinches minimum thickness per MIL-G-45204 Type II Grade C Class 1 over copper per MIL-C-14550 Hood: Passivated
Float Mount Hardware	Stainless steel	Passivate per QQ-P-35	Stainless steel	Passivate per QQ-P-35

PERFORMANCE SPECIFICATIONS

Wire Accommodation (AWG)	Solder - #20 Max. Crimp - #18- #30 Max.
Current Rating	#20; 5 Amp
Temperature Rating	-65°C to +150°C
Contact Resistance	55 @ 7.5 Amp
After Salt Spray, Millivolt Max.	test current

See pages 339 and 340 for complete M24308 cross reference.

DIELECTRIC WITHSTANDING VOLTAGE

	90° and Straight (Solder/Crimp)			
	Altitude (feet/m)			
	Sea Level	20,000/6,096	50,000/15,240	70,000/21,336
Average Flashover	1700/1500	1000/1000	650/500	500/500
Test	1250/1000	750/650	475/325	375/325

All voltage figures are rms AC 60 rms cps, measured at approximately +25°C, 50% rh. For additional performance specifications refer to MIL-C-24308 Test Extracts on page 385.

Non-Magnetic/No-Outgas Options

Suffix Code	Residual Magnetism	Shell Material (Finish)	Desired Results
NMB	200 Gamma Residual Magnetism Insulator. (Diallyl Phtalate per MIL-M-14 type SDG-F, color white.)	Bras Shells Per QQ-B-613 (Yellow Chromate over Cadmium per QQ-P-416, Type II, Class 2.)	Non-Magnetic No-Outgas
NMB-K52	200 Gamma Residual Magnetism Insulator. (Diallyl Phtalate per MIL-M-14 type SDG-F, color white.)	Brass Shells Per QQ-B-613 (Gold over copper per MIL-G-45204, Type II, Grade C, Class 1 over copper per MIL-C-14550.)	Non-Magnetic No-Outgas

Note: Look for the **NM** symbol for orderign information.

Contact Arrangements

Face View Pin Insert

Shell Size
Contact Arrangement
Contact Size

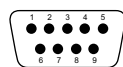

E

9

#20

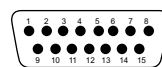

A

15

#20

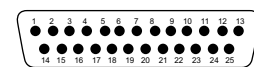

B

25

#20

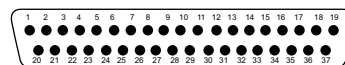

C

37

#20

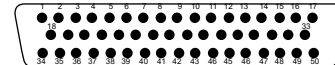

D

50

#20

Shell Size
Contact Arrangement
Contact Size

How to Order High Rel-Solder Cup Connectors (contacts are non-removable)



Mounting Options Available:

- 4-40 Clinch Nut - Add "E" to Part Number After "M"
- 4-40 Float Mount - Add "Y" to Part Number After "M"
- (Can be used in front or rear panel mount applications)

Example: DBME25S DEMY9P
DBMME25S DEMMY9P

Performance Specifications - Page 332.

Receptacles (Includes Socket Contacts) With .120" Through-Mounting Holes

Number of Contacts (Shell Size)	Standard	Military Version	M24308 Cross Reference
9 (E)	DEM9S	DEMM9S	M24308/1-1
15 (A)	DAM15S	DAMM15S	M24308/1-2
25 (B)	DBM25S	DBMM25S	M24308/1-3
37 (C)	DCM37S	DCMM37S	M24308/1-4
50 (D)	DDM50S	DDMM50S	M24308/1-5

Plugs (Includes Pin Contacts)* With .120" Through-Mounting Holes

Number of Contacts (Shell Size)	Standard	Military Version	M24308 Cross Reference
9 (E)	DEM9P	DEMM9P	M24308/3-1
15 (A)	DAM15P	DAMM15P	M24308/3-2
25 (B)	DBM25P	DBMM25P	M24308/3-3
37 (C)	DCM37P	DCMM37P	M24308/3-4
50 (D)	DDM50P	DDMM50P	M24308/3-5

NM Non-Magnetic/No Outgas-Add desired suffix code with desired option to end of part number.

Example: DEMA9PSNMB
DEMA9PSNMB-K52

Dimensions - High Rel Solder Cup Connectors

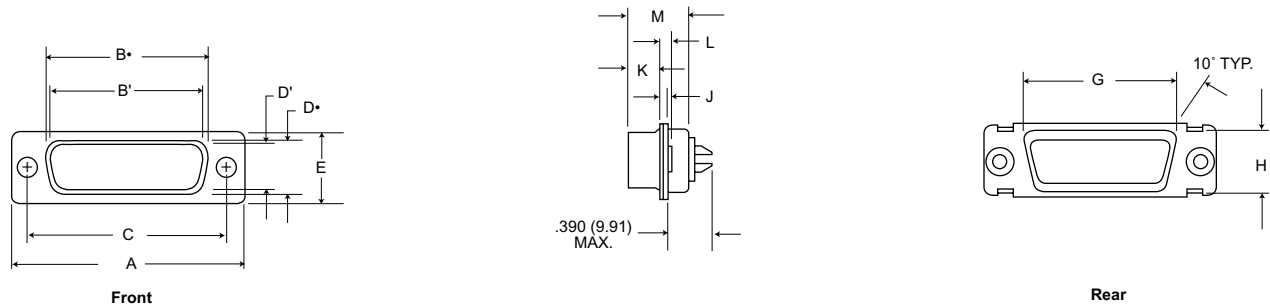

Part Number by Shell Size	A	B+	B'	C	D+	D'	E	G	H	J	K	L	M
DEM-9P	1.213 (30.81)	-	.666 (16.91)	.984 (24.99)	-	.329 (8.36)	.494 (12.55)	.759 (19.28)	.422 (10.72)	.030 (0.76)	.235 (5.94)	.048 (1.22)	.422 (10.72)
DEM-9S	1.213 (30.81)	.643 (16.33)	-	.984 (24.99)	.311 (7.90)	-	.494 (12.55)	.759 (19.28)	.422 (10.72)	.030 (0.76)	.243 (6.17)	.048 (1.22)	.429 (10.90)
DAM-15P	1.541 (39.14)	-	.994 (25.24)	1.312 (33.32)	-	.329 (8.36)	.494 (12.55)	1.083 (27.51)	.422 (10.72)	.030 (0.76)	.235 (5.97)	.048 (1.22)	.422 (10.72)
DAM-15S	1.541 (39.14)	.971 (24.66)	-	1.312 (33.32)	.311 (7.90)	-	.494 (12.55)	1.083 (27.51)	.422 (10.72)	.030 (0.76)	.243 (6.17)	.048 (1.22)	.429 (10.90)
DBM-25P	2.088 (53.03)	-	1.534 (38.96)	1.852 (47.04)	-	.329 (8.36)	.494 (12.55)	1.625 (41.27)	.422 (10.72)	.039 (0.99)	.230 (5.84)	.060 (1.52)	.426 (10.82)
DBM-25S	2.088 (53.03)	1.511 (38.38)	-	1.852 (47.04)	.311 (7.90)	-	.494 (12.55)	1.625 (41.27)	.422 (10.72)	.030 (0.76)	.243 (6.17)	.048 (1.22)	.429 (10.90)
DCM-37P	2.729 (69.31)	-	2.182 (55.42)	2.500 (63.50)	-	.329 (8.36)	.494 (12.55)	2.272 (57.71)	.422 (10.72)	.039 (0.99)	.230 (5.84)	.060 (1.52)	.426 (10.82)
DCM-37S	2.729 (69.31)	2.159 (54.84)	-	2.500 (63.50)	.311 (7.90)	-	.494 (12.55)	2.272 (57.71)	.422 (10.72)	.030 (0.76)	.243 (6.17)	.048 (1.22)	.429 (10.90)
DDM-50P	2.635 (66.92)	-	2.079 (52.81)	2.406 (61.11)	-	.441 (11.20)	.605 (15.37)	2.178 (55.32)	.534 (13.56)	.039 (0.99)	.230 (5.84)	.060 (1.52)	.426 (10.82)
DDM-50S	2.635 (66.92)	2.064 (52.43)	-	2.406 (61.11)	.423 (10.74)	-	.605 (15.37)	2.178 (55.32)	.534 (13.56)	.030 (0.76)	.243 (6.17)	.048 (1.22)	.429 (10.90)

*Dimensions B, D, G, and H are measured as outside dimensions at the bottom of the draw.
NOTE: B+ and D+ are the D.D. dims for socket side B' and D' are the I. D. dims. for pin side

Mounting Option Dimensions - Crimp Components

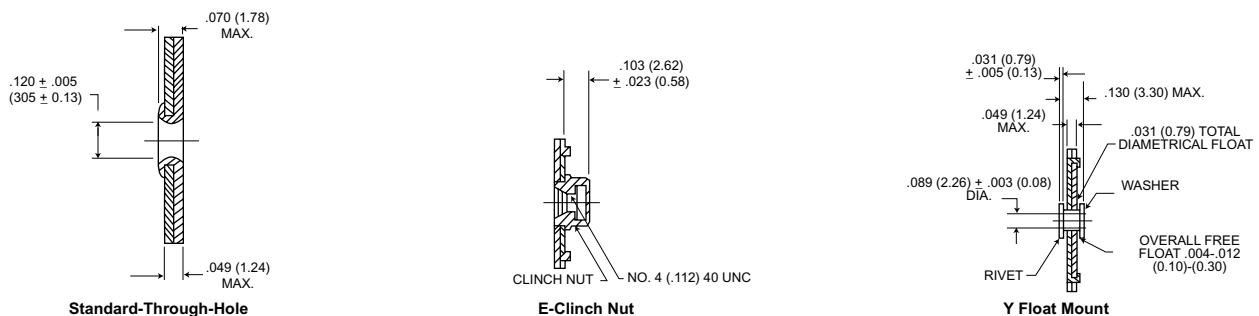

It is recommended that only one assembly, either pin or socket, be float mounted.

Dimensions are shown in inches (millimeters).
Dimensions subject to change.

How to Order - Crimp Connectors (contacts are removable)



Receptacles (Includes Socket Contacts) With .120" Through-Mounting Holes

Number of Contacts (Shell Size)	Standard	Military Version	M24308 Cross Reference
9 (E)	DEMA9S	DEMAM9S	M24308/2-1
15 (A)	DAMA15S	DAMAM15S	M24308/2-2
25 (B)	DBMA25S	DBMAM25S	M24308/2-3
37 (C)	DCMA37S	DCMAM37S	M24308/2-4
50 (D)	DDMA50S	DDMAM50S	M24308/2-5

Plugs (Includes Pin Contacts)* With .120" Through-Mounting Holes

Number of Contacts (Shell Size)	Standard	Military Version	M24308 Cross Reference
9 (E)	DEMA9P	DEMAM9P	M24308/4-1
15 (A)	DAMA15P	DAMAM15P	M24308/4-2
25 (B)	DBMA25P	DBMAM25P	M24308/4-3
37 (C)	DCMA37P	DCMAM37P	M24308/4-4
50 (D)	DDMA50P	DDMAM50P	M24308/4-5

To receive these connectors without contacts, add "F0" to end of part number.

Example: DBMA25SF0, DBMAM25SF0.

NM Non-Magnetic/No Outgas-Add desired suffix code with desired option to end of part number.

Example: DEMA9PSNMB
DEMA9PSNMB-K52

Crimp Connectors without contacts, add F0 to end of the part number and change K52 to K47.

Assembly Instructions - Page 363.

Performance Specifications - Page 332.

Mounting Options Available:

- 4-40 Clinch Nut - Add "E" to Part Number After "M" or "A"
 - 4-40 Flood Mount - Add "Y" to Part Number After "M" or "A"
- (Can be used in front or rear panel mount applications)

Example: DBMAE25S
DBMAM25S
DEMAY9P
DBMAMY9P

Dimensions - Crimp Connectors

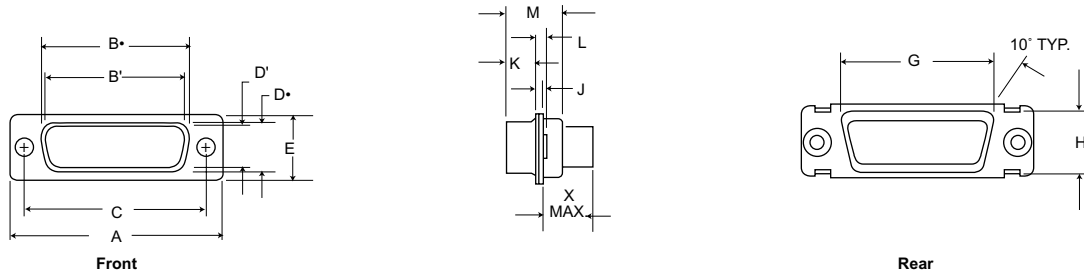

Part Number by Shell Size	A	B*	B'	C	D*	D'	E	G	H	J	K	L	M	X Max.
DEMA-9P	1.213 (30.81)	-	.666 (16.91)	.984 (24.99)	-	.329 (8.36)	.494 (12.55)	.759 (19.28)	.422 (10.72)	.030 (0.76)	.235 (5.97)	.048 (1.22)	.422 (10.72)	.345 (8.76)
DEMA-9S	1.213 (30.81)	.643 (16.33)	-	.984 (24.99)	.311 (7.90)	-	.494 (12.55)	.759 (19.28)	.422 (10.72)	.030 (0.76)	.243 (6.17)	.048 (1.22)	.429 (10.90)	.345 (8.76)
DAMA-15P	1.541 (39.14)	.971 (24.66)	-	1.312 (33.32)	.311 (7.90)	-	.494 (12.55)	1.083 (27.51)	.422 (10.72)	.030 (0.76)	.235 (5.97)	.048 (1.22)	.422 (10.72)	.345 (8.76)
DAMA-15S	1.541 (39.14)	.971 (24.66)	-	1.312 (33.32)	.311 (7.90)	-	.494 (12.55)	1.083 (27.51)	.422 (10.72)	.030 (0.76)	.243 (6.17)	.048 (1.22)	.429 (10.90)	.345 (8.76)
DBMA-25P	2.088 (53.03)	-	1.534 (38.96)	1.852 (47.04)	-	.329 (8.36)	.494 (12.55)	1.625 (41.27)	.422 (10.72)	.039 (0.99)	.230 (5.84)	.060 (1.52)	.426 (10.82)	.345 (8.76)
DBMA-25S	2.088 (53.03)	1.511 (38.38)	-	1.852 (47.04)	.311 (7.90)	-	.494 (12.55)	1.625 (41.27)	.422 (10.72)	.030 (0.76)	.243 (6.17)	.048 (1.22)	.429 (10.90)	.345 (8.76)
DCMA-37P	2.729 (69.31)	-	2.182 (55.42)	2.500 (63.50)	-	.329 (8.36)	.494 (12.55)	2.272 (57.71)	.422 (10.72)	.039 (0.99)	.230 (5.84)	.060 (1.52)	.426 (10.82)	.345 (8.76)
DCMA-37S	2.729 (69.31)	2.159 (54.84)	-	2.500 (63.50)	.311 (7.90)	-	.494 (12.55)	2.272 (57.71)	.422 (10.72)	.030 (0.76)	.243 (6.17)	.048 (1.22)	.429 (10.90)	.345 (8.76)
DDMA-50P	2.635 (66.92)	-	2.079 (52.81)	2.406 (61.11)	-	.441 (11.20)	.605 (15.37)	2.178 (55.32)	.534 (13.56)	.039 (0.99)	.230 (5.84)	.060 (1.52)	.426 (10.82)	.345 (8.76)
DDMA-50S	2.635 (66.92)	2.064 (52.43)	-	2.406 (61.11)	.423 (10.74)	-	.605 (15.37)	2.178 (55.32)	.534 (13.56)	.030 (0.76)	.243 (6.17)	.048 (1.22)	.429 (10.90)	.345 (8.76)

Mounting Option Dimensions - Crimp Components

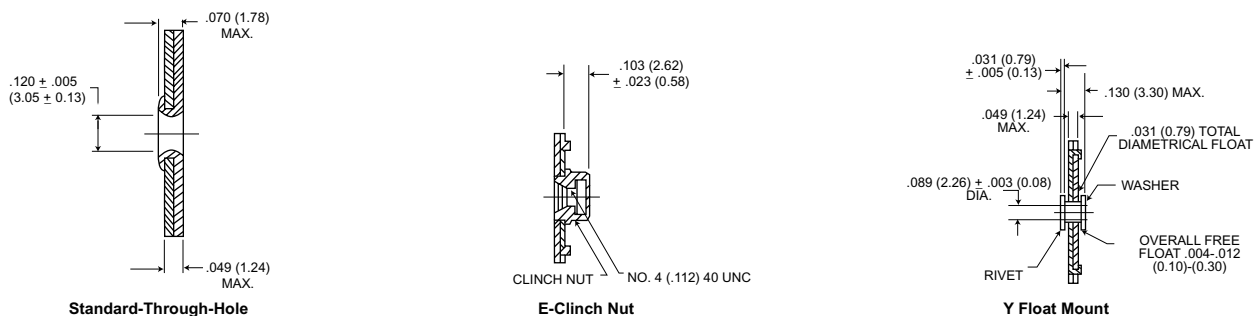

It is recommended that only one assembly, either pin or socket, be float mounted.

Dimensions are shown in inches (millimeters).
Dimensions subject to change.

High Rel Crimp Contacts

MATERIALS AND FINISHES

Contact Size	Wire Size Accom.	Standard Finish				Military Finish		NM	
		Pin		Socket		Pin	Socket	NMB	
		Pin	Socket	Pin	Socket	Pin	Socket	Pin	Socket
20	20, 22, 24	330-5291-000	031-1007-000	330-5291-037	031-1007-042	330-5291-037	031-1007-057		
20-18	1 #18 & 2 #22	330-5291-001	031-1007-001	330-5291-055	031-1007-054	-	-		
20-26	26, 28, 30	330-5291-004	031-1007-004	330-5291-050	031-1007-048	-	-		
22D	22, 24, 26, 28			030-2042-002*	031-1147-002*	-	-		

MIL-C-39029 Cross-Reference

Contact Size	Wire Size Accom.	M39029	M24308	Cannon Part No.
20 Pin	20/22/24	/64-369	/11-1	330-5291-037
20 Socket	20/22/24	/36-368	/10-1	031-1007-042
22D Pin	24/26/28	/58-360	/13-1	030-2042-000
22D Socket	22/24/26/28	/57-354	/12-1	031-1147-000

Assembly Instructions - Page 363

*50 microinch AU over copper, no stripes.

Tooling

Insertion/Extraction Tools

CIET-20HD

Contact Size	AWG	Plastic Insertion/Extraction		Plastic Extraction	
		Part No.	Description	Part No.	Description
20	20, 22, 24	980-2000-426	CIET-20HD	323-7010-000	CET-20-11
2026	26, 28, 30	980-2000-426	CIET 20HD	323-7010-000	CET-20-11
2018	1 #18	None	None	274-5016-002	CET-20-15
	2 #22	None	None	274-5016-002	CET-20-15
22D	22, 24, 26, 28	274-7048-000	CIET 22D	None	None
High Power	12, 16	274-7003-000	CIET 12	None	None
High Volt	#20	274-7003-000	CIET 12	None	None

Hand Crimp Tools



M22520/1-01

M22520/2-01

Contact Size	AWG	Crimp Tool		Locator	
		Part No.	Description	Part No.	Description
		995-0001-584	M22520/2-01	995-0001-604	M22520/2-08
20	20, 22, 24	995-0001-585	M22520/2-01	995-0001-244	TH25
2026	26, 28, 30	995-0001-584	M22520/2-01	995-0001-325	L3198-20HD
2018	1 #18	995-0001-584	M22520/2-01	980-0005-722	K250
	2 #22				
22D	22, 24, 26, 28	995-0001-584	M22520/2-01	995-0001-739	M22520/2-06

Semi-Automatic Crimp Machines

The CBT-646, Vibra-Bowl Crimper is pneumatically powered, electronically controlled machine. It is designed to semi-automatically crimp closed barrel, machined contacts, as used in the aerospace and commercial industries. The machine will accommodate wire sizes 30 thru 12 AWG. The CBT-646 is actuated automatically upon insertion of a pre-stripped stranded or single conductor wire. The CBT-646 meets all Mil. Spec. requirements for crimping closed barrel contacts.

Machine Crimp Rate: 1300 + per hour

Power Requirements: Electrical = 115 Vac., 60 Hz, 5A
Pneumatic = 85 psi., 2 cu. ft. per min.

Products: Most ITT Cannon Commercial and Aerospace closed barrel contacts, wire sizes 30 thru 12 AWG.
(See connector line for part numbers.)

CBT-646

How to Order - High-Rel Printed Circuit Mount Connectors

Straight PC Tail, Receptacles (Includes Socket Contacts) With .120 (3.15) Through-Mounting Holes.



Number of Contacts (Shell Size)	PC Tails - .030 (0.76) Diameter			Wire Wrap Post - .024 (0.61) Square	
	.127 (3.23) ± .027 (0.69) Long Post	.158 (4.01) ± .027 (0.69) Long Post	.183 (4.65) ± .027 (0.69) Long Post	.405 (10.29) ± .027 (0.69) Long Post (Two Wrap)	.530 (13.46) ± .027 (0.69) Long Post (Three Wrap)
9 (E) Standard	DEM9SE	DEM9SM	DEM9SZ	DEM9SF179	DEM9SF179A
9 (E) Military	DEMM9SE	DEMM9SM	DEMM9SZ	DEMM9SF179	DEMM9SF179A
15 (A) Standard	DAM15SE	DAM15SM	DAM15SZ	DAM15SF179	DAM15SF179A
15 (A) Military	DAMM15SE	DAMM15SM	DAMM15SZ	DAMM15SF179	DAMM15SF179A
25 (B) Standard	DBM25SE	DBM25SM	DBM25SZ	DBM25SF179	DBM25SF179A
25 (B) Military	DBMM25SE	DBMM25SM	DBMM25SZ	DBMM25SF179	DBMM25SF179A
37 (C) Standard	DCM37SE	DCM37SM	DCM37SZ	DCM37SF179	DCM37SF179A
37 (C) Military	DCMM37SE	DCMM37SM	DCMM37SZ	DCMM37SF179	DCMM37SF179A
50 (D) Standard	DDM50SE	DDM50SM	DDM50SZ	DDM50SF179	DDM50SF179A
50 (D) Military	DDMM50SE	DDMM50SM	DDMM50SZ	DDMM50SF179	DDMM50SF179A

NM Non-Magnetic/No-Outgas - Add desired suffix code (NMB, NM-K52) to end of part number. Example: DEM95ZNM-B-K52

Straight PC Tail, Plug (Includes Pin Contacts) With .120 (3.15) Through-Mounting Holes



Number of Contacts (Shell Size)	PC Tails - .030 (0.76) Diameter			Wire Wrap Post - .024 (0.61) Square	
	.127 (3.23) ± .027 (0.69) Long Post	.158 (4.01) ± .027 (0.69) Long Post	.183 (4.65) ± .027 (0.69) Long Post	.405 (10.29) ± .027 (0.69) Long Post (Two Wrap)	.530 (13.46) ± .027 (0.69) Long Post (Three Wrap)
9 (E) Standard	DEM9PE	DEM9PM	DEM9PZ	DEM9PF179	DEM9PF179A
9 (E) Military	DEMM9PE	DEMM9PM	DEMM9PZ	DEMM9PF179	DEMM9PF179A
15 (A) Standard	DAM15PE	DAM15PM	DAM15PZ	DAM15PF179	DAM15PF179A
15 (A) Military	DAMM15PE	DAMM15PM	DAMM15PZ	DAMM15PF179	DAMM15PF179A
25 (B) Standard	DBM25PE	DBM25PM	DBM25PZ	DBM25PF179	DBM25PF179A
25 (B) Military	DBMM25PE	DBMM25PM	DBMM25PZ	DBMM25PF179	DBMM25PF179A
37 (C) Standard	DCM37PE	DCM37PM	DCM37PZ	DCM37PF179	DCM37PF179A
37 (C) Military	DCMM37PE	DCMM37PM	DCMM37PZ	DCMM37PF179	DCMM37PF179A
50 (D) Standard	DDM50PE	DDM50PM	DDM50PZ	DDM50PF179	DDM50PF179A
50 (D) Military	DDMM50PE	DDMM50PM	DDMM50PZ	DDMM50PF179	DDMM50PF179A

NM Non-Magnetic/No-Outgas - Add desired suffix code (NMB, NM-K52) to end of part number. Example: DEM9PZNM-B-K52

Dimensions

Printed Circuit Applications

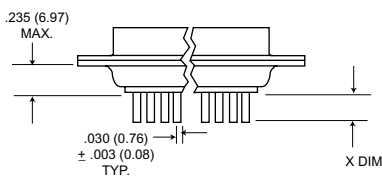

*All MIL-C-24308 connectors come with .250 (0.10) length spacers.

Wire Wrapping Applications

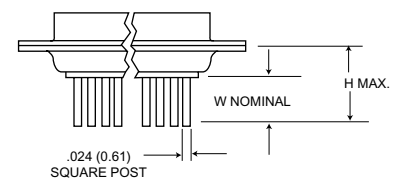

Code (Last Letter of Part Number)	Straight X ± .027 (0.69)
E	.127 (3.22)
M	.158 (4.01)
Z	.183 (4.65)

Modification Code	Number of Wraps	W	H
F179	2	.405 (10.29)	.655 (16.64)
F179A	3	.530 (13.46)	.780 (19.81)

How to Order - High-Rel Printed Circuit Mount Connectors

Right Angle PC Tail Receptacles, With Bracket (.120 (3.15) Though-Holes Only)



Number of Contacts (Shell Size)	PC Tails - .030 (0.76) Diameter		
	.127 (3.23) ± .027 (0.69) Long Post	.158 (4.01) ± .027 (0.69) Long Post	.183 (4.65) ± .027 (0.69) Long Post
9 (E) Standard	DEM9SD	DEM9SL	DEM9SS
9 (E) Military	DEM9SD	DEM9SL	DEM9SS
15 (A) Standard	DAM15SD	DAM15SL	DAM15SS
15 (A) Military	DAMM15SD	DAMM15SL	DAMM15SS
25 (B) Standard	DBM25SD	DBM25SL	DBM25SS
25 (B) Military	DBMM25SD	DBMM25SL	DBMM25SS
37 (C) Standard	DCM37SD	DCM37SL	DCM37SS
37 (C) Military	DCMM37SD	DCMM37SL	DCMM37SS
50 (D) Standard	DDM50SD	DDM50SL	DDM50SS
50 (D) Military	DDMM50SD	DDMM50SL	DDMM50SS

NM Non-Magnetic/No-Outgas - Add desired suffix cod (NMB, NM-K52) to end of part number. Example: DEM9SLNMB-K52

Right Angle PC Tail Plug, With Bracket (.120 (3.15) Through-Holes Only)



Number of Contacts (Shell Size)	PC Tails - .030 (0.76) Diameter		
	.127 (3.23) ± .027 (0.69) Long Post	.158 (4.01) ± .027 (0.69) Long Post	.183 (4.65) ± .027 (0.69) Long Post
9 (E) Standard	DEM9PD	DEM9PL	DEM9PS
9 (E) Military	DEM9PD	DEM9PL	DEM9PS
15 (A) Standard	DAM15PD	DAM15PL	DAM15PS
15 (A) Military	DAMM15PD	DAMM15PL	DAMM15PS
25 (B) Standard	DBM25PD	DBM25PL	DBM25PS
25 (B) Military	DBMM25PD	DBMM25PL	DBMM25PS
37 (C) Standard	DCM37PD	DCM37PL	DCM37PS
37 (C) Military	DCMM37PD	DCMM37PL	DCMM37PS
50 (D) Standard	DDM50PD	DDM50PL	DDM50PS
50 (D) Military	DDMM50PD	DDMM50PL	DDMM50PS

NM Non-Magnetic/No-Outgas - Add desired suffix cod (NMB, NM-K52) to end of part number. Example: DDM9SLNM-K52

Dimensions-Right Angle 90° D Subminiature

Connectors with brackets cannot be ordered with float mounts or clinch nuts.

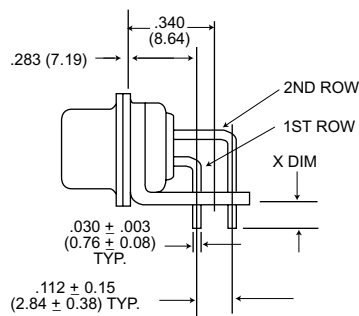

DE, DA, DB, DC Sizes

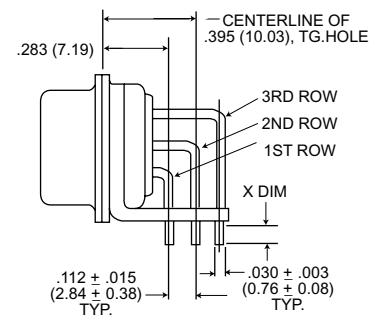

DD Size

Code Last Letter of P/N's	Right Angle With Bracket	X ± .027 (0.69)
D	•	.127 (3.22)
L	•	.158 (4.01)
S	•	.183 (4.65)

Performance Specifications - Page 332.

PC Board Hole Patterns

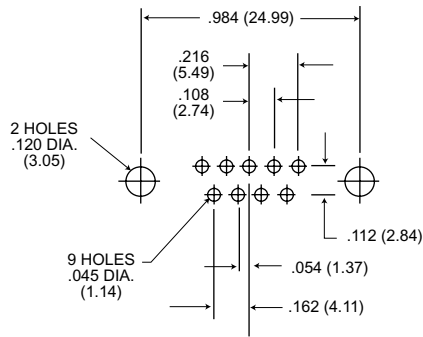

DE Size
9 Positions

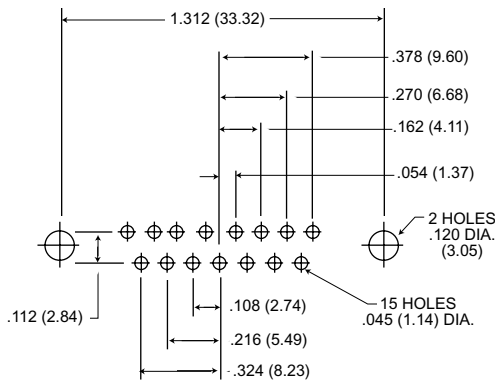

DA Size
15 Positions

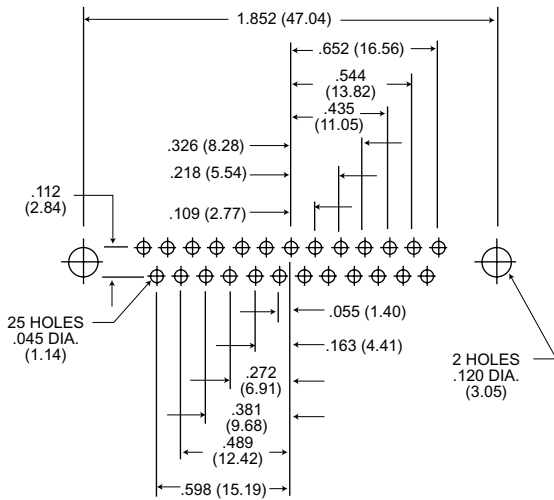

DB Size
25 Positions

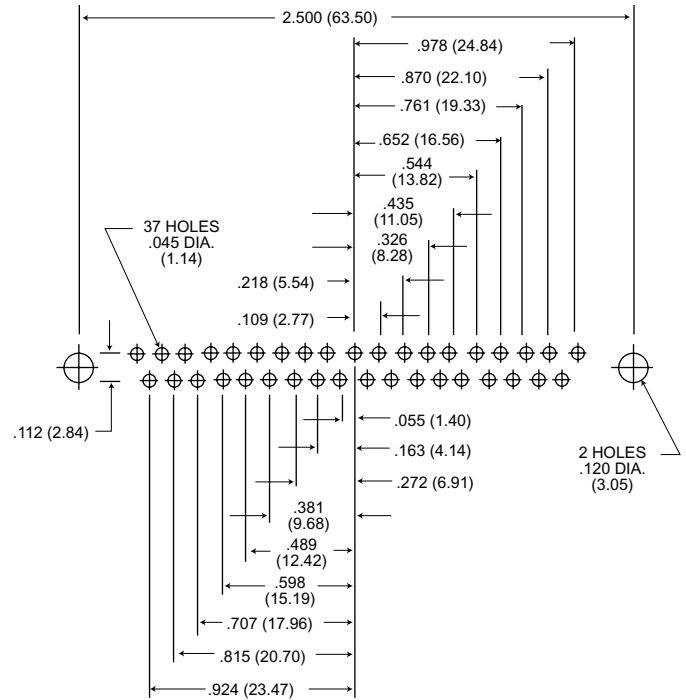

DC Size
37 Positions

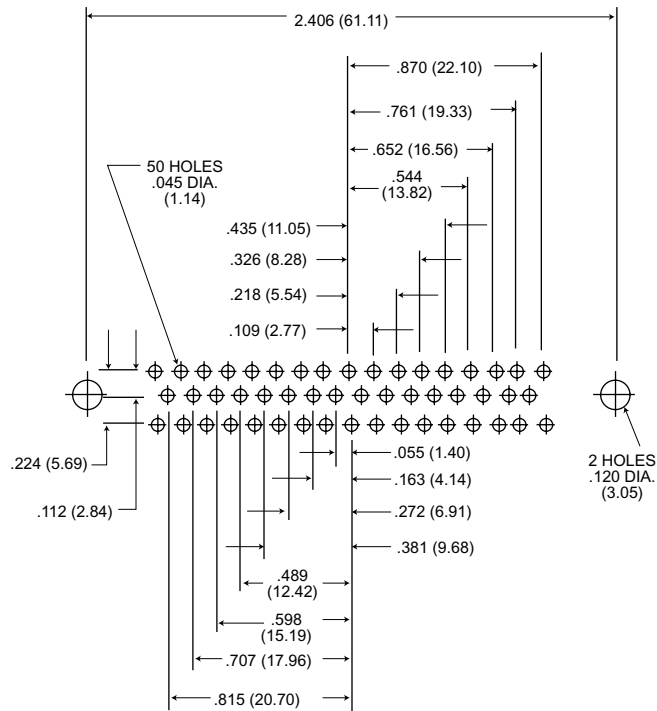

DD Size
50 Positions

MIL-C-24308 Cross Reference

Military Part Number	Cannon Part Number	Military Part Number	Cannon Part Number	Military Part Number	Cannon Part Number
M24308/1-1	DEMMS9S	M24308/2-485	DCMAMY37S-F0	M24308/6-5	DDMAM50SNM
M24308/1-2	DAMM15S	M24308/2-486	DDMAMY50S-F0	M24308/6-6	DEMAMT9SNM
M24308/1-3	DBMM25S	M24308/3-1	DEMMP9P	M24308/6-7	DAMAMT15SNM
M24308/1-4	DCMM37S	M24308/3-2	DAMM15P	M24308/6-8	DBMAMT25SNM
M24308/1-5	DDMM50S	M24308/3-3	DBMM25P	M24308/6-9	DCMAMT37SNM
M24308/1-12	DEMMP9S	M24308/3-4	DCMM37P	M24308/6-10	DDMAMT50SNM
M24308/1-13	DAMMF15S	M24308/3-5	DDMM50P	M24308/6-15	DDMAM78SNM
M24308/1-14	DBMMF25S	M24308/3-12	DEMMP9P	M24308/6-259	DEMAMF9SNM
M24308/1-15	DCMMF37S	M24308/3-13	DAMMF15P	M24308/6-260	DAMAMF15SNM
M24308/1-16	DDMMF50S	M24308/3-14	DBMMF25P	M24308/6-261	DBMAMF25SNM
M24308/1-23	DEMMY9S	M24308/3-15	DCMMF37P	M24308/6-262	DCMAMF37SNM
M24308/1-24	DAMMY15S	M24308/3-16	DDMMF50P	M24308/6-263	DDMAMF50SNM
M24308/1-25	DBMMY25S	M24308/4-1	DEMAM9P	M24308/6-268	DDMAMF78SNM
M24308/1-26	DCMMY37S	M24308/4-2	DAMAM15P	M24308/6-270	DEMAMFT9SNM
M24308/1-27	DDMMY50S	M24308/4-3	DBMAM25P	M24308/6-271	DAMAMFT15SNM
M24308/2-1	DEMAM9S	M24308/4-4	DCMAM37P	M24308/6-272	DBMAMFT25SNM
M24308/2-2	DAMAM15S	M24308/4-5	DDMAM50P	M24308/4-5	DDMAMFT37SNM
M24308/2-3	DBMAM25S	M24308/4-6	DEMAMT9P	M24308/4-6	DDMAMFT50SNM
M24308/2-4	DCMAM37S	M24308/4-7	DAMAMT15P	M24308/4-7	DEMAM9SNM-F0
M24308/2-5	DDMAM50S	M24308/4-8	DBMAMT25P	M24308/4-8	DAMAM15SNM-F0
M24308/2-6	DEMAMT9S	M24308/4-9	DCMAMT37P	M24308/4-9	DDMAM25SNM-F0
M24308/2-7	DAMAMT15S	M24308/4-10	DDMAMT50P	M24308/4-10	DCMAM37SNM-F0
M24308/2-8	DBMAMT25S	M24308/4-15	DDMAM78P	M24308/4-15	DDMAM50SNM-F0
M24308/2-9	DCMAMT37S	M24308/4-259	DEMAM9P-F0	M24308/4-259	DDMAM78SUM-F0
M24308/2-10	DDMAMT50S	M24308/4-260	DAMAM15P-F0	M24308/4-260	DEMAMF9SNM-F0
M24308/2-15	DDMAM78S	M24308/4-261	DBMAM25P-F0	M24308/4-261	DAMAMF15SNM-F0
M24308/2-23	DEMAMF9S	M24308/4-262	DCMAM37P-F0	M24308/4-262	DBMAMF25SNM-F0
M24308/2-24	DAMAMF15S	M24308/4-263	DDMAM50P-F0	M24308/4-263	DCMAMF37SNM-F0
M24308/2-25	DBMAMF25S	M24308/4-268	DDMAM78P-F0	M24308/4-268	DDMAMF50SNM-F0
M24308/2-26	DCMAMF37S	M24308/4-302	DEMAMF9P	M24308/4-302	DDMAMF78SNM-F0
M24308/2-27	DDMAMF50S	M24308/4-303	DAMAMF15P	M24308/4-303	DEMAMY9SNM
M24308/2-32	DDMAMF78S	M24308/4-304	DBMAMF25P	M24308/4-304	DAMAMY15SNM
M24308/2-34	DEMAMFT9S	M24308/4-305	DCMAMF37P	M24308/4-305	DBMAMY25SNM
M24308/2-35	DAMAMFT15S	M24308/4-306	DDMAMF50P	M24308/4-306	DCMAMY37SNM
M24308/2-36	DBMAMFT25S	M24308/4-311	DCMAMF78P	M24308/4-311	DDMAMY50SNM
M24308/2-37	DCMAMFT37S	M24308/4-313	DEMAMFT9P	M24308/4-313	DDMEMYT9SNM
M24308/2-38	DDMAMFT50S	M24308/4-314	DAMAMFT15P	M24308/4-314	DAMAMYT15SNM
M24308/2-281	DEMAM9S-F0	M24308/4-315	DBMAMFT25P	M24308/4-315	DBMAMYT25SNM
M24308/2-282	DAMAM15S-F0	M24308/4-316	DCMAMFT37P	M24308/4-316	DCMAMYT37SNM
M24308/2-283	DBMAM25S-F0	M24308/4-317	DDMAMFT50P	M24308/4-317	DDMAMYT50SNM
M24308/2-284	DCMAM37S-F0	M24308/4-324	DEMAMF9P-F0	M24308/4-324	DEMAMY9SNM-F0
M24308/2-285	DDMAM50S-F0	M24308/4-325	DAMAMF15P-F0	M24308/4-325	DAMAMY15SNM-F0
M24308/2-290	DDMAM78S-F0	M24308/4-326	DBMAMF25P-F0	M24308/4-326	DBMAMY25SNM-F0
M24308/2-292	DEMAMF9S-F0	M24308/4-327	DCMAMF37P-F0	M24308/4-327	DCMAMY37SNM-F0
M24308/2-293	DAMAMF15S-F0	M24308/4-328	DDMAMF50P-F0	M24308/4-328	DDMAMY50SNM-F0
M24308/2-294	DBMAMF25S-F0	M24308/4-333	DDMAMF78P-F0	M24308/7-1	DEMM9PNM
M24308/2-295	DCMAMF37S-F0	M24308/5-1	DEMMP9SNM	M24308/7-2	DAMM15PNM
M24308/2-296	DDMAMF50S-F0	M24308/5-2	DAMM15SNM	M24308/7-3	DBMM25PNM
M24308/2-301	DDMAMF78S-F0	M24308/5-3	DBMM25SNM	M24308/7-4	DCMM37PNM
M24308/2-335	DBMAMR25S	M24308/5-4	DCMM37SNM	M24308/7-5	DDMMS0PNM
M24308/2-336	DCMAMR37S	M24308/5-5	DDMM50SNM	M24308/7-12	DEMMP9PNM
M24308/2-341	DAMAMR15S	M24308/5-12	DEMMP9SNM	M24308/7-13	DAMMF15PNM
M24308/2-342	DEMAMY9S	M24308/5-13	DAMMF15SNM	M24308/7-14	DBMMF25PNM
M24308/2-343	DAMAMY15S	M24308/5-14	DBMMF25SNM	M24308/7-15	DCMMF37PNM
M24308/2-344	DBMAMY25S	M24308/5-15	DCMMF37SNM	M24308/7-16	DDMMF50PNM
M24308/2-345	DCMAMY37S	M24308/5-16	DDMMF50SNM	M24308/8-1	DEMAM9PNM
M24308/2-346	DDMAMY50S	M24308/5-23	DDMMY9SNM	M24308/8-2	DAMAM15PNM
M24308/2-353	DEMAMYT9S	M24308/5-24	DAMMY15SNM	M24308/8-3	DBMAM25PNM
M24308/2-354	DAMAMYT15S	M24308/5-25	DBMMY25SNM	M24308/8-4	DCMAM37PNM
M24308/2-355	DBMAMYT25S	M24308/5-26	DCMMY37SNM	M24308/8-5	DDMAM50PNM
M24308/2-356	DCMAMYT37S	M24308/5-27	DDMMY50SNM	M24308/8-6	DEMAMT9PNM
M24308/2-357	DDMAMYT50S	M24308/6-1	DEMAM9SNM	M24308/8-7	DAMAMT15PNM
M24308/2-482	DEMAMY9S-F0	M24308/6-2	DAMAM15SNM	M24308/8-8	DBMAMT25PNM
M24308/2-483	DEMAMY15S-F0	M24308/6-3	DBMAM25SNM	M24308/8-9	DCMAMT37PNM
M24308/2-484	DEMAMY25S-F0	M24308/6-4	DCMAM37SNM	M24308/8-10	DDMAMT50PNM

MIL-C-24308 Cross Reference (Continued)

Military Part Number	Cannon Part Number	Military Part Number	Cannon Part Number	Military Part Number	Cannon Part Number
M24308/8-15	DDMAM78PNM	M24308/23-8	DAMM15SZ	M24308/24-8	DAMM15PZ
M24308/8-259	DEMAM9PNM-FO	M24308/23-9	DBMM25SZ	M24308/24-9	DBMM25PZ
M24308/8-260	DAMAM15PNM-FO	M24308/23-10	DCMM37SZ	M24308/24-10	DCMM37PZ
M24308/8-261	DBMAM25PNM-FO	M24308/23-11	DDMM50SZ	M24308/24-11	DDMM50PZ
M24308/8-262	DCMAM37PNM-FO	M24308/23-13	DEMM9SH	M24308/24-13	DEMM9PH
M24308/8-263	DDMAM50PNM-FO	M24308/23-14	DAMM15SH	M24308/24-14	DAMM15PH
M24308/8-269	DDMAM78PNM-FO	M24308/23-15	DBMM25SH	M24308/24-15	DBMM25PH
M24308/8-302	DEMAMF9PNM	M24308/23-16	DCMM37SH	M24308/24-16	DCMM37PH
M24308/8-303	DAMAMF15PNM	M24308/23-17	DDMM50SH	M24308/24-17	DDMM50PH
M24308/8-304	DBMAMF25PNM	M24308/23-19	DEMM9SX	M24308/24-19	DEMM9PX
M24308/8-305	DCMAMF37PNM	M24308/23-20	DAMM15SX	M24308/24-20	DAMM15FX
M24308/8-306	DDMAMF50PNM	M24308/23-21	DBMM25SX	M24308/24-21	DBMM25PX
M24308/8-311	DDMAMF78PNM	M24308/23-22	DCMM37SX	M24308/24-22	DCMM37PX
M24308/8-313	DEMAMFT9PNM	M24308/23-23	DDMM50SX	M24308/24-23	DDMM50PX
M24308/8-314	DAMAMFT15PNM	M24308/23-25	DEMM9SD	M24308/24-25	DEMM9PD
M24308/8-315	DBMAMFT25PNM	M24308/23-26	DAMM15SD	M24308/24-26	DAMM15PD
M24308/8-316	DCMAMFT37PNM	M24308/23-27	DBMM25SD	M24308/24-27	DBMM25PD
M24308/8-317	DDMAMFT50PNM	M24308/23-28	DCMM37SD	M24308/24-28	DCMM37PD
M24308/8-324	DEMAMF9PNM-FO	M24308/23-29	DDMM50SD	M24308/24-29	DDMM50PD
M24308/8-325	DAMAMF15PNM-FO	M24308/23-31	DEMM9SL	M24308/24-31	DEMM9PL
M24308/8-326	DBMAMF25PNM-FO	M24308/23-32	DAMM15SL	M24308/24-32	DAMM15PL
M24308/8-327	DCMAMF37PNM-FO	M24308/23-33	DBMM25SL	M24308/24-33	DBMM25PL
M24308/8-328	DDMAMF50PNM-FO	M24308/23-34	DCMM37SL	M24308/24-34	DCMM37PL
M24308/3-333	DDMAMF78PNM-FO	M24308/23-35	DDMM50SL	M24308/24-35	DDMM50PL
M24308/9-1	DEH9P002	M24308/23-37	DEMM9SA	M24308/24-37	DEMM9PA
M24308/9-2	DAH15P002	M24308/23-38	DAMM15SA	M24308/24-38	DAMM15PA
M24308/9-3	DBH25P002	M24308/23-39	DBMM25SA	M24308/24-39	DBMM25PA
M24308/9-4	DCH37P002	M24308/23-40	DCMM37SA	M24308/24-40	DCMM37PA
M24308/9-5	DDH50P002	M24308/23-41	DDMM50SA	M24308/24-41	DDMM50PA
M24308/9-6	DEH9P001	M24308/23-43	DEMM9SG	M24308/24-43	DEMM9PG
M24308/9-7	DAH15P001	M24308/23-44	DAMM15SG	M24308/24-44	DAMM15PG
M24308/9-8	DBH25P001	M24308/23-45	DBMM25SG	M24308/24-45	DBMM25PG
M24308/9-9	DCH37P001	M24308/23-46	DCMM37SG	M24308/24-46	DCMM37PG
M24308/9-10	DDH50P001	M24308/23-47	DDMM50SG	M24308/24-47	DDMM50PG
M24308/9-11	DEH9P202	M24308/23-49	DEMM9SS	M24308/24-49	DEMM9PS
M24308/9-12	DAH15P202	M24308/23-50	DAMM15SS	M24308/24-50	DAMM15PS
M24308/9-13	DBH25P202	M24308/23-51	DBMM25SS	M24308/24-51	DBMM25PS
M24308/9-14	DCH37P202	M24308/23-52	DCMM37SS	M24308/24-52	DCMM37PS
M24308/9-15	DDH50P202	M24308/23-53	DDMM50SS	M24308/24-53	DDMM50PS
M24308/9-16	DEH9P201	M24308/23-55	DEMM9SW	M24308/24-55	DEMM9PW
M24308/9-17	DAH15P201	M24308/23-56	DAMM15SW	M24308/24-56	DAMM15PW
M24308/9-18	DBH25P201	M24308/23-57	DBMM25SW	M24308/24-57	DBMM25PW
M24308/9-19	DCH37P201	M24308/23-58	DCMM37SW	M24308/24-58	DCMM37PW
M24308/9-20	DDH50P201	M24308/23-59	DDMM50SW	M24308/24-59	DDMM50PW
M24308/23-1	DEMM9SM	M24308/24-1	DEMM9PM	M24308/26-1	D20418-2
M24308/23-2	DAMM15SM	M24308/24-2	DAMM15PM	M24308/26-2	D20418-39
M24308/23-3	DBMM25SM	M24308/24-3	DBMM25PM		
M24308/23-4	DCMM37SM	M24308/24-4	DCMM37PM		
M24308/23-5	DDMM50SM	M24308/24-5	DDMM50PM		
M24308/23-7	DEMM9SZ	M24308/24-7	DEMM9PZ		

Crimp



(See page 342)

Printed Circuit



(See page 343)

Performance and Material Specifications

MATERIALS AND FINISHES

	Standard		Military	
	Material	Finish	Material	Finish
Shell	Steel per ASTM A-620	Yellow chromate over cadmium QQ-P-416 Type II Class 2	Steel per ASTM A-620	Yellow chromate over cadmium QQ-P-416 Type II Class 2
Insulator	Diallyl phthalate glass-filled per MIL-M-14, type SDG-F color green	-	Diallyl phthalate glass-filled per MIL-M-14, type SDG-F color green	-
Contact	Copper alloy	Gold over nickel	Copper alloy Crimp socket has stainless steel hood	Gold 50 microinches minimum thickness per MIL-G-45204 Type II Grade C Class 1 over copper per MIL-C-14550 Hood: Passivated
Float Mount Hardware	Stainless steel	Passivate per QQ-P-35	Stainless steel	Passivate per QQ-P-35

PERFORMANCE SPECIFICATIONS

Wire Accommodation (AWG)	Crimp-#22-#28 AWG
Current Rating	#22: 5 Amp
Temperature Rating	-65°C to +150°C
Contact Resistance After Salt Spray, Millivolt Max.	55 @ 5 Amp test current

DIELECTRIC WITHSTANDING VOLTAGE

Test	90° and Straight (Solder/Crimp)		
	Altitude (feet/m)		
	Sea Level	70,000/21,336	100,000
	1000	325	175

All voltage figures are rms AC 60 rms cps, measured at approximately +25°C, 50% rh. For additional performance specifications refer to MIL-C-24308 Test Extracts on page 385.

Contact Arrangements

Face View Pin Insert

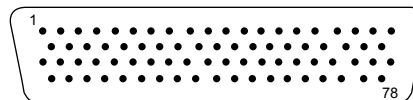

Shell Size
Contact Arrangement
Contact Size

D
78
#22

How to Order - Crimp Connectors



Receptacle (Includes Socket Contacts) With .120" Through-Mounting Holes

Number Contacts (Shell Size)	Standard Version	Military Version
78 (D)	DDMA78S	DDMAM78S

Plugs (Includes Pin Contacts)* With .120" Through-Mounting Holes

Number Contacts (Shell Size)	Standard Version	Military Version
78 (D)	DDMA78P	DDMAM78P

Note: 1) To receive the connector without contacts, add "FO" to end of part number.

Example: DBMA25SFO, DBMAM25SFO.
2) For loose contacts and tooling see page 5.

Mounting Options Available:

- 4-40 Clinch Nut - ADD "E" to Part Number After "M" or "A"
 - 4-40 Float Mount - Add "Y" to Part Number After "M" or "A"
- (Can be used in front or rear panel mount applications)

Dimensions - Crimp Connectors

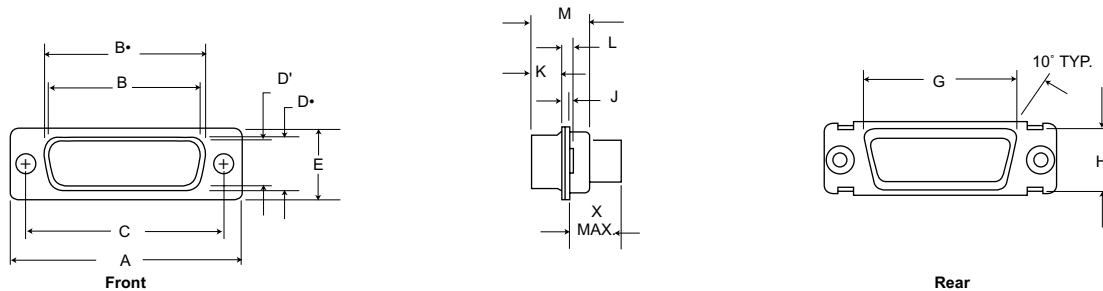

Part Number by Shell Size	A	B*	B'	C	D*	D'	E	G	H	J	K	L	M	X Max
DDM78P	2.635 (66.92)	-	2.079 (52.81)	2.406 (61.11)	-	.441 (11.20)	.605 (15.37)	2.178 (55.32)	.534 (13.56)	.039 (0.99)	.231 (5.87)	.060 (1.52)	.426 (10.82)	.345 (8.76)
DDM78S	2.635 (66.92)	2.064 (52.43)	-	2.406 (61.11)	.423 (10.41)	-	.605 (15.37)	2.178 (55.32)	.534 (13.56)	.030 (0.76)	.243 (6.17)	.045 (1.14)	.429 (10.90)	.345 (8.76)

Mounting Option Dimensions

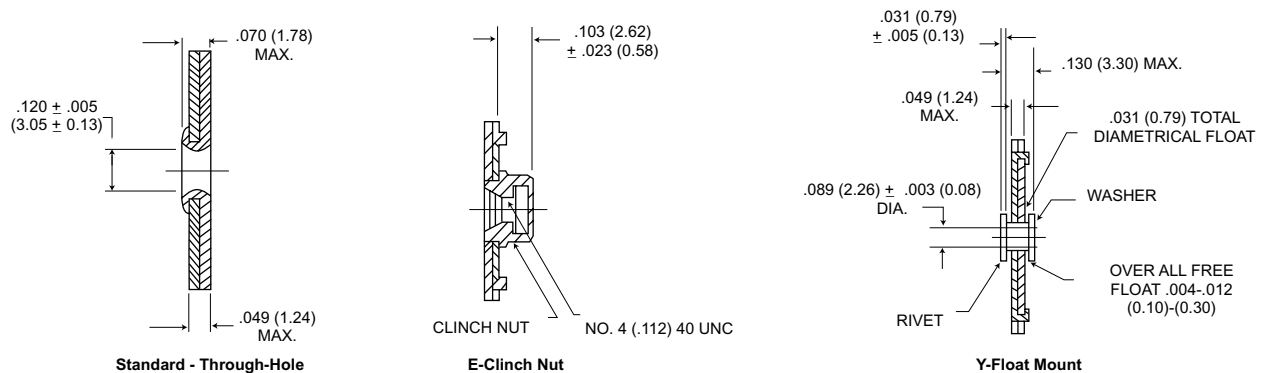

It is recommended that only on assembly, either pin or socket, be float mounted.

High Rel Printed Circuit Mount Connector - Straight PC Tail



Receptacle



Plug

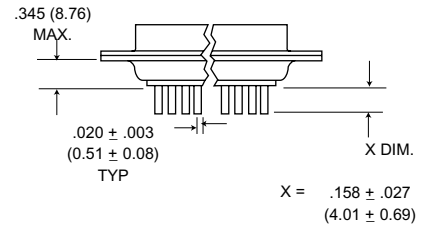

With .120 (3.15) Through-Mounting Holes

Number Contacts (Shell Size)		Receptacle	NM Non-Magnetic	
			Receptacle	Plug
78 (D) Standard		DDMA50913-499	-	DDMA50913-500
78 (D) Military		DDMA50913-439	DDMA50913-445	DDMA50913-440

High Rel 90° PCB Connectors



Receptacle



Plug

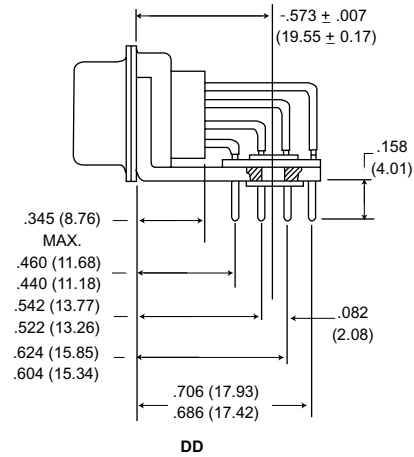

Connectors with brackets cannot be ordered with float mounts or clinch nuts.

Number Contacts (Shell Size)		Receptacle	NM Non-Magnetic	
			Receptacle	Plug
78 (0) Standard		DDMA50913-467	-	DDMA50913-468
78 (0) Military		DDMA50913-437	DDMA50913-473	DDMA50913-438

High Rel Crimp Contacts

Contact Size	Wire Size Accommodation	Cannon Part Number			
		M39029	M24308*	Pin	Socket
22D Pin	22, 24, 26, 28	/58-360	/13-1	030-2042-00	-
22D Socket	22, 24, 26, 28	/57-354	/12-1	-	031-1147-000

* Superseded by M39029

Straight and 90° Board Hole Patterns

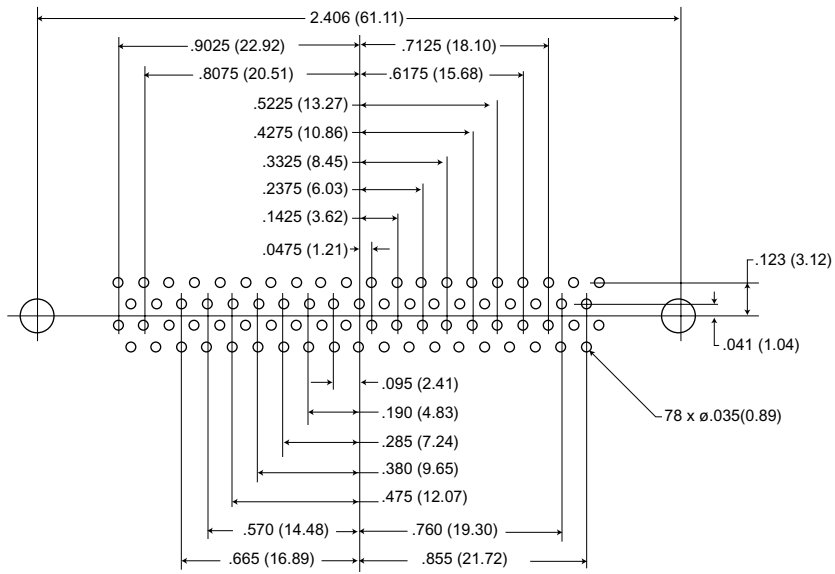

DD-78

Tooling

Hand Tools

Contact Size	AWG	Plastic Insertion/Extraction	Crimp Tool	Locator
22D	22, 24, 26, 28	274-7048-000 CIET-22D	995-0001-584 M22520/2-01	995-0001-739 M22520/2-06

Combo D[®]

Combination D Subminiature connectors are the fastest growing segment of the D Subminiature market. ITT Cannon engineering teams, in keeping pace with the demands of the industry, have developed the broadest selection of combination D Subminiature available.

We offer the ability to intergrate signal and coax, high power, and high voltage. You can mix red, green, and blue video lines with signal and up to 40 amps of power in the same package.

Design variations of the new Combo D connector, versus other packaging methods, include the proven ITT Cannon polarized "D" shape to prevent mis-mating; dense, space-saving packaging; and diverse mounting options. Choose from a variety of cable and printed wiring board selections. Printed wiring board combos come pre-assembled with fixed contacts eliminating the need to buy several components.

This new line of connectors offers you **unlimited design versatility**.



Straight and right angle printed wiring board contacts are available in both coax and high power versions.

Performance and Material Specifications

CONNECTOR ASSEMBLIES

Description	Material	Finish
Shell	Steel or Brass	Yellow Chromate Cadmium or Gold over Nickel
Insulator	Thermoplastic or Diallyl Phthalate, UL 94V-0 rated.	None
Size 20 contacts when applicable	Copper alloy	50μ inches gold over copper or 100μ gold over copper.
Bracket	Steel	Yellow Chromate over Cadmium
Rivnut	Steel or Copper alloy	

COAXIAL ASSEMBLY

Contacts and shells	Copper alloy	Gold over nickel or 50μ inches gold over copper.
Ring, retaining	Copper alloy	Nickel or Gold
Insulator	Teflon	None
U.L. File Number: E8572		

DIELECTRIC WITHSTANDING VOLTAGE

Type of Contact		Altitude (feet/m)							
		Sea Level		20,000/6096		50,000/15240		70,000/1336	
		90'	Straight	90'	Straight	90'	Straight	90'	Straight
Center Conductor to Coaxial Shell	Average Flashover	1200	1500	900	1000	600	700	400	500
	Test	800	1000	600	650	400	475	275	325
Coaxial Shell to Nearest Standard Solder Pot Contact	Average Flashover	•	1500	•	1500	•	900	•	650
	Test	•	1000	•	1000	•	600	•	425
High Power contact and/or Coaxial Shell to Plug Shell	Average Flashover	1500	1500	1000	1000	500	500	500	500
	Test	1000	1000	650	650	325	325	325	325
#20 Signal	Average Flashover	1700		1000		650		500	
	Test	1250		750		475		375	
HV Contact to Nearest Contact or to Shell	Average Flashover	3800	3800	2300	2300	900	900	650	650
	Test	2800	2800	1700	1700	675	675	475	475

All voltage figures are rms AC 60 rms cps, measured at approximately +25°C, 50% rh.

Impedance: 50 ohm

PERFORMANCE DATA

Signal Contact Current Rating	5 Amp
Temperature Rating	-65°C to +150°C
Signal Contact Resistance millivolt max	55 @ 7.5 Amp test current
Coax Impedance	50 ohm
Coax VSWR	Less than 1.3-1.0 up to 500 megahertz
Coax Insertion Loss	.1 db loss at 500 megahertz.

See *Commercial D Subminiature* catalog for additional Combo D options, including 75 ohm Coax.



Cannon

Dimensions are shown in inches (millimeters).
Dimensions subject to change.

www.ittcannon.com

Combo D® - Coaxial/ 75 and 50 Ohm

Coaxial Housing With Solder Cup Signal Contacts



- Cable combinations supplied with preloaded solder signal contacts
- 50 ohm coax contacts supplied separately (see pages 347-348)

Clinch Nut and Float Mount Options Available:

Add: E = 4-40 Clinch Nut

Y = Float Mounting

Example: DAMME3W3P

DANNT3W3P

Mounting Method Detail - Page 334.

Layout	Military Socket	Military Pin	NM Non-Magnetic Socket	NM Non-Magnetic Pin
DE-5W1	DEMMSW1S	DMM5W1P	DEM5W1S-NMB-K52	DEM5W1P-NMB-K52
DA-7W2	DAMM7W2S	DAMM7W2P	DAM7W2S-NMB-K52	DAM7W2P-NMB-K52
DA-11W1	DAMM11W1S	DAMM11W1P	DAM11W1S-NMB-K52	DAM11W1P-NMB-K52
DA-3W3	DAMM3W3S	DAMM3W3P	DAM3W3S-NMB-K47	DAM3W3P-NMB-K47
DB-5W5	DBMM5W5S	DBMM5W5P	DBM5W5S-NMB-K47	DBM5W5P-NMB-K47
DB-9W4	DBMM9W4S	DBMM9W4P	DBM9W4S-NMB-K52	DBM9W4P-NMB-K52
DB-13W3	DBMM13W3S	DBMM13W3P	DBM13W3S-NMB-K52	DBM13W3P-NMB-K52
DB-17W2	DBMM17W2S	DBMM17W2P	DBM17W2S-NMB-K52	DBM17W2P-NMB-K52
DB-21W1	DBMM21W1S	DBMM21W1P	DBM21W1S-NMB-K52	DBM21W1P-NMB-K52
DC-8W8	DCMM8W8S	DCMM8W8P	DCM8W8S-NMB-K47	DCM8W8P-NMB-K47
DC-13W6	DCMM13W6S	DCMM13W6P	DCM13W6S-NMB-K52	DCM13W6P-NMB-K52
DC-17W5	DCMM17W5S	DCMM17W5P	DCM17W5S-NMB-K52	DCM17W5P-NMB-K52
DC-21WA4	DCMM21WA4S	DCMM21WA4P	DCM21WA4S-NMB-K52	DCM21WA4P-NMB-K52
DC-25W3	DCMM25W3S	DCMM25W3P	DCM25W3S-NMB-K52	DCM25W3P-NMB-K52
DC-27W2	DCMM27W2S	DCMM27W2P	DCM27W2S-NMB-K52	DCM27W2P-NMB-K52
DD-24W7	DDMM24W7S	DDMM24W7P	DDM24W7S-NMB-K52	DDM24W7P-NMB-K52
DD-36W4	DDMM36W4S	DDMM36W4P	DDM36W4S-NMB-K52	DDM36W4P-NMB-K52
DD-43W2	DDMM43W2S	DDMM43W2P	DDM43W2S-NMB-K52	DDM43W2P-NMB-K52
DD-47W1	DDMM47W1S	DDMM47W1P	DDMC47W1S-NMB-K52	DDM47W1P-NMB-K52

Contact Arrangements

(Will accommodate Removable Coax, Power and/or High Voltage Contacts)

Note: Color Code - Pin Connector: Red, Socket Connector: Blue

Shell Size	E	A	A	A	B	B
Contact Arrangement	5W1	3W3	7W2	11W1	5W5	9W4
No. of Signal Contacts	4 #20	0	5 #20	10 #20	0	5 #20
No. of Coaxial Contacts	1	3	2	1	5	4
Shell Size	B	B	B	B	C	C
Contact Arrangement	13W3	17W2	21W1	21W1	8W8	8W8
No. of Signal Contacts	10 #20	15 #20	20 #20	20 #20	0	0
No. of Coaxial Contacts	3	2	1	1	8	8
Shell Size	C	C	C	C	C	C
Contact Arrangement	13W6	17W5	21WA4	21WA4	25W3	25W3
No. of Signal Contacts	7 #20	12 #20	17 #20	17 #20	22 #20	22 #20
No. of Coaxial Contacts	6	5	4	4	3	3
Shell Size	C	D	D	D	D	D
Contact Arrangement	27W2	24W7	24W7	36W4	36W4	36W4
No. of Signal Contacts	25 #20	17 #20	17 #20	32 #20	32 #20	32 #20
No. of Coaxial Contacts	2	7	7	4	4	4
Shell Size	D	D	D	D	D	D
Contact Arrangement	43W2	47W1	47W1	46 #20	46 #20	46 #20
No. of Signal Contacts	41 #20	46 #20	46 #20	1	1	1
No. of Coaxial Contacts	2	1	1	1	1	1

See *Commerical D Subminiature* catalog for additional Combo D options, including 75 ohm Coax.



Cannon

Dimensions are shown in inches (millimeters).
Dimensions subject to change.

www.ittcannon.com

Combo D® - Coaxial/50 Ohm

Cable Combinations - 50 Ohm Coaxial Contacts

Color Code: Receptacle - Blue; Plug - Red

Straight Crimp Braid

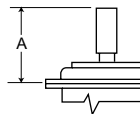

(Dimensions include outer sleeve).

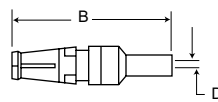

Receptacle

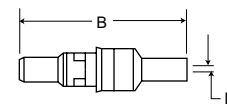

Plug

	Crimp/Crimp		<i>NM</i> - Non-Magnetic		A Max.	B Max.	D Min.	RG Cable No.	
	Gold Over Nickel	Gold Over Nickel	50µ in. Gold Over Copper	50µ in. Gold Over Copper				Old	New
Plug		DM53740	DM53740-17		.739 (18.8)	.945 (24.00)	.040 (1.00)	196/U	178B/U
Plug	DM53740-37*	DM53740-1	DM53740-15	DM53740-36	.739 (18.8)	.945 (24.00)	.067 (1.70)	187/U	179B/U
Plug		DM53740-35			.739 (18.8)	.945 (24.00)	.067 (1.70)	-	RD316
Plug		DM53740-3	DM53740-16		.847 (21.5)	1.037 (26.34)	.110 (2.79)	195/U	180B/U
Plug		DM53740-5	DM53740-18		.847 (21.5)	1.037 (26.34)	.125 (3.18)	58/U	58B/U
Receptacle		DM53742	DM53742-18		.739 (18.8)	.945 (24.00)	.040 (1.00)	196/U	1788/U
Receptacle	DM53742-38*	DM53742-1	DM53742-16	DM53742-37	.739 (18.8)	.945 (24.00)	.067 (1.70)	187/U	179B/U
Receptacle		DM53742-36			.739 (18.8)	.945 (24.00)	.067 (1.70)	-	RD316
Receptacle		DM53742-3	DM53742-17		.847 (21.5)	1.037 (26.34)	.110 (2.79)	195/U	180B/U
Receptacle		DM53742-5	DM53742-19		.847 (21.5)	1.037 (26.34)	.125 (3.18)	58/U	58B/U

* Consult factory for center contact crimp tooling.

Straight Crimp Braid

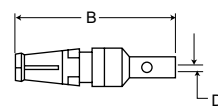
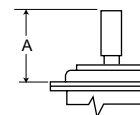

Receptacle

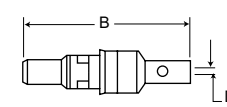

Plug

			<i>NM</i> - Non-Magnetic		A Max.	B Max.	D Min.	RG Cable No.	
	Gold Over Nickel	50µ in. Gold Over Copper	50µ in. Gold Over Copper					Old	New
Plug	DM53740-5008	DM53740-5105			.739 (18.8)	.945 (24.00)	.040 (1.00)	196/U	178B/U
Plug	DM53740-5001	DM53740-5099	DM53740-5147		.739 (18.8)	.945 (24.00)	.067 (1.70)	187/U	179B/U
Plug	DM53740-5145				.739 (18.8)	.945 (24.00)	.067 (1.70)	-	RD316
Plug	DM53740-5002	DM53740-5104			.847 (21.5)	1.037 (26.34)	.110 (2.79)	195/U	180B/U
Plug	DM53740-5005	DM53740-5101			.847 (21.5)	1.037 (26.34)	.125 (3.18)	58/U	58/U
Receptacle	DM53742-5006	DM53742-5092			.739 (18.8)	.945 (24.00)	.040 (1.00)	196/U	178B/U
Receptacle	DM53742-5001	DM53742-5089	DM53742-5127		.739 (18.8)	.945 (24.00)	.067 (1.70)	187/U	179B/U
Receptacle	DM53742-5126				.739 (18.8)	.945 (24.00)	.067 (1.70)	-	RD316
Receptacle	DM53742-5002	DM53742-5091			.847 (21.5)	1.037 (26.34)	.110 (2.79)	195/U	180B/U
Receptacle	DM53742-5004	DM53742-5086			.847 (21.5)	1.037 (26.34)	.125 (3.18)	58/U	58/U
Plug (Short Type)	DM53740-5000	DM53740-5100		.670 (17.0)	.874 (22.20)	.045 (1.14)	196/U	178B/U	
Receptacle (Short Type)	DM53742-5000	DM53742-5085		.670 (17.0)	.874 (22.20)	.045 (1.14)	196/U	178B/U	

Right Angle Solder Braid

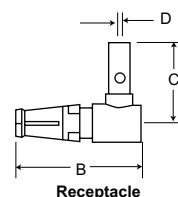
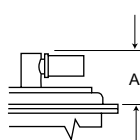

Receptacle

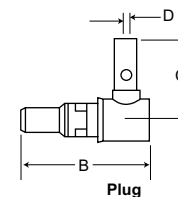

Plug

			A Max.	B Max.	C	D Min.	RG Cable No.	
	Gold Over Nickel	50µ in. Gold Over Copper					Old	New
Plug	DM53741-5000	DM53741-5059	.530 (13.46)	.745 (18.92)	.544 (15.10)	.040 (1.00)	196/U	178B/U
Plug	DM53741-5001	DM53741-5062	.530 (13.46)	.745 (18.92)	.544 (15.10)	.067 (1.70)	187/U 188/U	178B/U 316B/U
Plug	DM53741-5003	DM53741-5063	.530 (13.46)	.745 (18.92)	.630 (16.00)	.110 (2.79)	195/U	180B/U
Plug	DM53741-5004	DM53741-5060	.530 (13.46)	.745 (18.92)	.630 (16.00)	.125 (3.18)	58/U	58/U
Receptacle	DM53743-5000	DM53743-5073	.530 (13.46)	.745 (18.92)	.594 (15.09)	.040 (1.00)	196/U	178B/U
Receptacle	DM53743-5001	DM53743-5076	.530 (13.46)	.745 (18.92)	.594 (15.09)	.067 (1.70)	187/U 188/U	179B/U 316B/U
Receptacle	DM53743-5003	DM53743-5077	.530 (13.46)	.745 (18.92)	.630 (16.00)	.110 (2.79)	195/U	180B/U
Receptacle	DM53743-5004	DM53743-5074	.530 (13.46)	.745 (18.92)	.630 (16.00)	.125 (3.18)	58/U	58B/U

Highlighted part numbers indicate standard product; usually available with shorter lead times.

See *Commerical D Subminiature* catalog for additional Combo D options, including 75 ohm Coax.

Combo D® - Coaxial/50 Ohm

Cable Combinations - 50 Ohm Coaxial Contacts (Continued)

Right Angle Crimp Braid

(Dimensions include outer sleeve.)
Color Code: Receptacle - Blue; Plug - Red

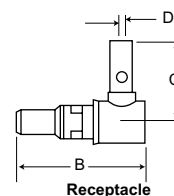
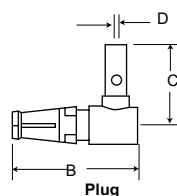
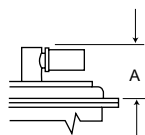

	Part Number		A Max.	B Ref.	C	D ± .005 (0.13)	RG Cable No.	
	Gold Over Nickel	50µ in. Gold Over Copper					Old	New
Plug	DM53741	DM53741-12	.530 (13.46)	.745 (18.92)	.594 (15.10)	.045 (1.14)	196/U	178B/U
Plug	DM53741-1	DM53741-11	.530 (13.46)	.745 (18.92)	.594 (15.10)	.072 (1.83)	187/U	179B/U
							188/U	316B/U
Plug	DM53741-3	DM53741-10	.530 (13.46)	.745 (18.92)	.630 (16.00)	.110 (2.79)	195/U	180B/U
Plug	DM53741-4	DM53741-13	.530 (13.46)	.745 (18.92)	.630 (16.00)	.125 (3.18)	58/U	58B/U
Receptacle	DM53743-2	DM53743-18	.530 (13.46)	.745 (18.92)	.594 (15.10)	.045 (1.14)	196/U	178B/U
Receptacle	DM53743-3	DM53743-16	.530 (13.46)	.745 (18.92)	.594 (15.10)	.072 (1.83)	187/U	179B/U
							188/U	316B/U
Receptacle	DM53743-5	DM53743-17	.530 (13.46)	.745 (18.92)	.630 (16.00)	.110 (2.79)	195/U	180B/U
Receptacle	DM53743-6	DM53743-19	.530 (13.46)	.745 (18.92)	.630 (16.00)	.125 (3.18)	58/U	58B/U

Insertion/Extraction Instructions

Coaxial, High Power and High Voltage Contacts

Insertion

No insertion tool is required. The contact is easily snapped in from the rear of the connector.

RED COLOR CODED CONNECTOR
ACCEPTS PLUG CONTACTS.

BLUE COLOR CODED CONNECTORS ACCEPTS RECEPTACLE
CONTACTS INSERT FROM TERMINAL END AS SHOWN BELOW.

INSERT

INSERT

PLUG CONTACT
D*M PLUG

RECEPTACLE CONTACT
D*M RECEPTACLE

Extraction

CET-C6B

The CET-C6B tool extracts coaxial, high power and high voltage contacts (Plug and receptacle). Part number 070064-0000.

Operating Instructions:

To extract the coax contact, hold the tool by the body and insert the tip into the front of the contact cavity until it bottoms and closes the coax retaining ring. Holding the body in this position securely enough to keep coax retaining ring closed, push the plunger; contact will be pushed out of the rear of the assembly.

TOOL PLUNGER
COAXIAL, H.V., OR
POWER CONTACTS
EXTRACT
TOOL TIP
EXTRACTION TOOL CET-C6B

Hand Tool with intergral die set for all coax straight crimp braid. Part Number: 070051-0000 (CCT-DM)

See *Commerical D Subminiature* catalog for additional Combo D options, including 75 ohm Coax.

Combo D® - Coaxial/50 Ohm

Coax Assembly Instructions

Trim Dimensions

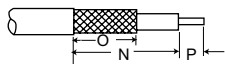

RG Cable No.	Straight			Right Angle		
	N	O	P	N	O	P
196/U, 178B/U, 187/U 188/U, 179B/U, 316B/U	.312 (7.92)	.250 (6.35)	.078 (1.98)	.375 (9.52)	.234 (5.94)	.062 (1.57)
195/U, 180B/U 58/U, 58B/U	.375 (9.52)	.312 (7.92)	.078 (1.98)	.422 (10.69)	.312 (7.92)	.094 (2.39)

All tolerances $\pm .010$ (0.25)

Crimp Tooling

RG Cable No.	Tool P/N	Description	Closure
196/U, 178B/U	070051-0000	CCT-DM	C
187/U, 179B/U 188/U, 316B/U	070051-0000	CCT-DM	B
195/U, 180B/U 58/U, 58B/U	070051-0000	CCT-DM	A

90° Coaxial

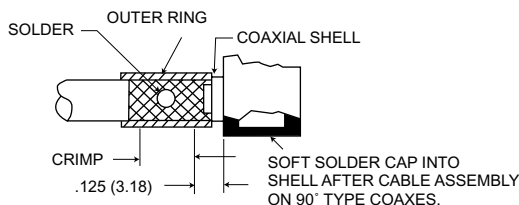
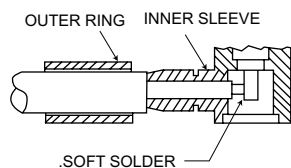

Straight Coaxial

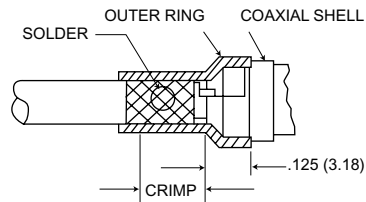
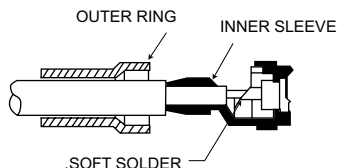

STEP 1: Straight and 90° Coaxials

Slide the outer ring over the cable jacket. Trim the cable as specified in the table of Coax Cable Trim Dimensions. Insert the cable dielectric and center conductor into the inside diameter of the inner sleeve. Then solder the center conductor to the coax center contact.

STEP 2: Straight and 90° Coaxials

Slide the outer ring forward until it is flush with the coax shell containing the braid between the outer ring and the inner sleeve. For solder type coaxes, soft solder the outer ring to the assembly through the cross-drilled solder hold. For crimp type coaxes, crimp with the appropriate tool in the area defined.

See *Commerical D Subminiature* catalog for additional Combo D options, including 75 ohm Coax.

Combo D® - Coaxial/50 Ohm

Right Angle Receptacle for PCB Mounting



PCB Layouts - Page 352

Military part numbers come complete with fixed, female, signal and coaxial contacts and right angle brackets.

Military part numbers come with coaxial contacts.

Non-magnetic part numbers must use coaxial contacts from Page 347 and do not come with brackets.

Layout	Military	NM Non-Magnetic
DE-5W1	DEMMP5X1SP	DEM5W1SP-NMB-K52
DA-7W2	DAMMP7X2SP	DAM7W2SP-NMB-K52
DA-11W1	DAMMP11X1SP	DAM11W1SP-NMB-K52
DA-3W3	DAMMP3X3SP	DAM3W3SP-NMB-K47
DB-5W5	DBMMP5X5SP	DBM5W5SP-NMB-K47
DB-9W4	DBMMP9X4SP	DBM9W4SP-NMB-K52
DB-13W3	DBMMP13X3SP	DBM13W3SP-NMB-K52
DB-17W2	DBMMP17X2SP	DBM17W2SP-NMB-K52
DB-21W1	DBMMP21X1SP	DBM21W1SP-NMB-K52
DC-8W8	DCMMP8X8SP	DCM8W8SP-NMB-K47
DC-13W6	DCMMP13X6SP	DCM13W6SP-NMB-K52
DC-17W5	DCMMP17X5SP	DCM17W5SP-NMB-K52
DC-21WA4	DCMMP21XA4SP	DCM21WA4SP-NMB-K52
DC-25W3	DCMMP25X3SP	DCM25W3SP-NMB-K52
DC-27W2	DCMMP27X2SP	DCM27W2SP-NMB-K52

Dimensions

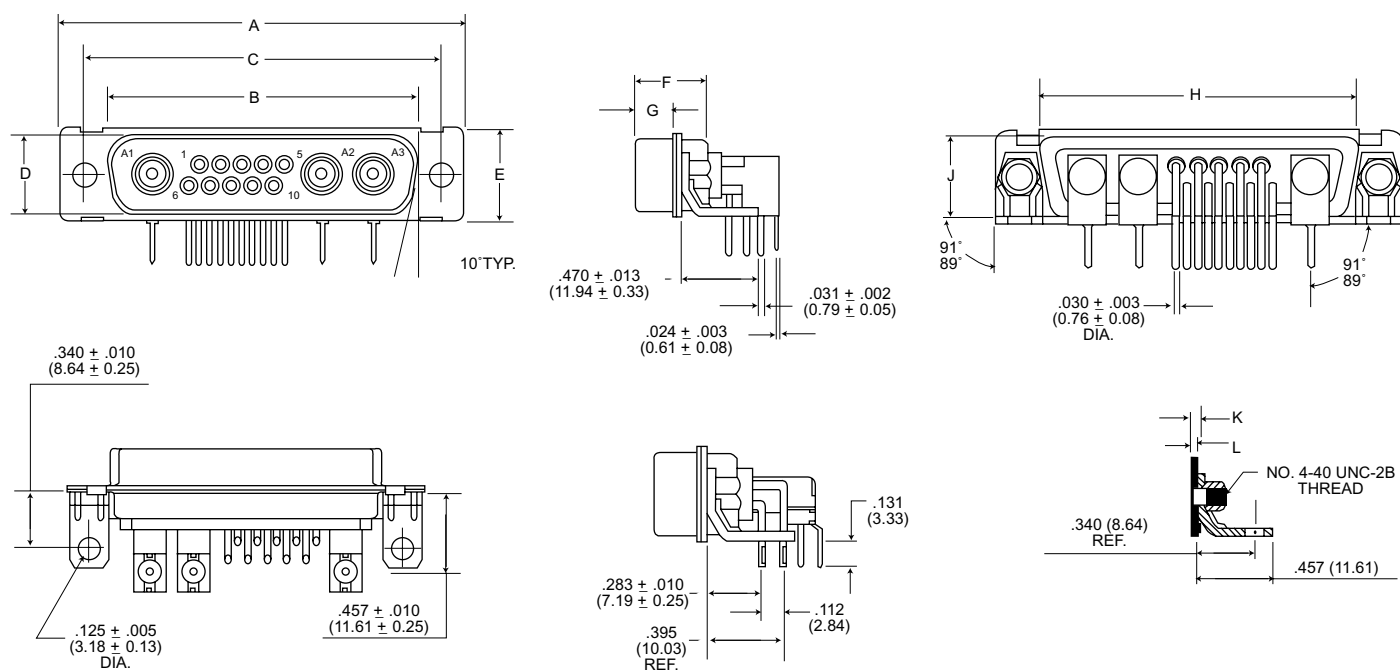

SOCKET CONNECTOR ASSEMBLY (Female)

Shell Size	A ± .015 (0.38)	B ± .005 (0.13)	C ± .005 (0.13)	D ± .005 (0.13)	E ± .015 (0.38)	F ± .005 (0.13)	G ± .005 (0.13)	H ± .010 (0.25)	J ± .010 (0.25)	K ± .013 (0.33)	L ± .010 (0.25)
DE	1.213 (30.81)	.643 (16.33)	.984 (24.99)	.311 (7.90)	.494 (12.55)	.429 (10.90)	.243 (6.17)	.759 (19.28)	.422 (10.72)	.048 (1.22)	.030 (0.76)
DA	1.541 (39.14)	.971 (24.66)	1.312 (33.32)	.311 (7.90)	.494 (12.55)	.429 (10.90)	.243 (6.17)	1.083 (27.51)	.422 (10.72)	.048 (1.22)	.030 (0.76)
DB	2.088 (53.03)	1.511 (38.38)	1.852 (47.04)	.311 (7.90)	.494 (12.55)	.429 (10.90)	.243 (6.17)	1.625 (41.27)	.422 (10.72)	.048 (1.22)	.039 (0.99)
DC	2.729 (69.31)	2.159 (54.84)	2.500 (63.50)	.311 (7.90)	.494 (12.55)	.429 (10.90)	.243 (6.17)	2.272 (57.71)	.422 (10.72)	.048 (1.22)	.039 (0.99)

See *Commerical D Subminiature* catalog for additional Combo D options, including 75 ohm Coax.



Cannon

Dimensions are shown in inches (millimeters).
Dimensions subject to change.

www.ittcannon.com

Combo D® - Coaxial/50 Ohm

Right Angle Plug for PCB Mounting



PCB Layouts - Page 352

Military part numbers come complete with fixed, female, signal and right angle brackets.

Military part numbers come with coaxial contacts.

Non-magnetic part numbers must use coaxial contacts from Page 347 and do not come with brackets.

Layout	Military	NM Non-Magnetic
DE-5W1	DEMMP5X1PP	DEM5W1PP-NMB-K52
DA-7W2	DAMMP7X2PP	DAM7W2PP-NMB-K52
DA-11W1	DAMM11X1PP	DAM11W1PP-NMB-K52
DA-3W3	DAMM3X3PP	DAM3W3P-NMB-K47
DB-5W5	DBMM5X5PP	DBM5W5P-NMB-K47
DB-9W4	DBMM9X4PP	DBM9W4PP-NMB-K52
DB-13W3	DBMM13X3PP	DBM13W3PP-NMB-K52
DB-17W2	DBMM17X2PP	DBM17W2PP-NMB-K52
DB-21W1	DBMM21X1PP	DBM21W1PP-NMB-K52
DC-8W8	DCMM8X8PP	DCM8W8P-NMB-K47
DC-13W6	DCMM13X6PP	DCM13W6PP-NMB-K52
DC-17W5	DCMM17X5PP	DCM17W5PP-NMB-K52
DC-21WA4	DCMM21XA4PP	DCM21WA4PP-NMB-K52
DC-25W3	DCMM25X3PP	DCM25W3PP-NMB-K52
DC-27W2	DCMM27X2PP	DCM27W2PP-NMB-K52

Dimensions

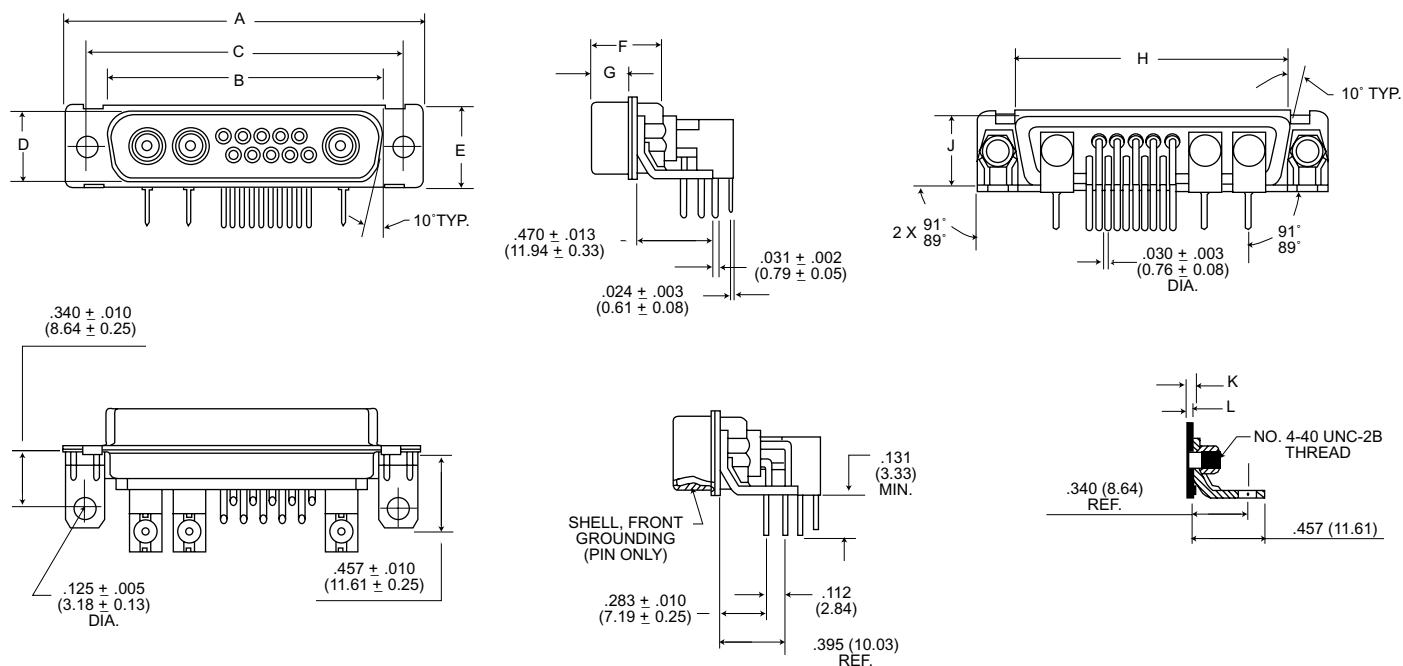

PLUG CONNECTOR ASSEMBLY (Male)

Shell Size	A ± .015 (0.38)	B ± .005 (0.13)	C ± .005 (0.13)	D ± .005 (0.13)	E ± .015 (0.38)	F ± .005 (0.13)	G ± .006 (0.15)	H ± .010 (0.25)	J ± .010 (0.25)	K ± .013 (0.33)	L ± .010 (0.25)
DE	1.213 (30.81)	.666 (16.91)	.984 (24.99)	.329 (8.36)	.494 (12.55)	.422 (10.72)	.236 (5.99)	.759 (19.28)	.422 (10.72)	.048 (1.22)	.030 (0.76)
DA	1.541 (39.14)	.994 (25.24)	1.312 (33.32)	.329 (8.36)	.494 (12.55)	.422 (10.72)	.236 (5.99)	1.083 (27.51)	.422 (10.72)	.048 (1.22)	.030 (0.76)
DB	2.088 (53.03)	1.534 (38.96)	1.852 (47.04)	.329 (8.36)	.494 (12.55)	.426 (10.82)	.231 (5.87)	1.625 (41.27)	.422 (10.72)	.060 (1.52)	.039 (0.99)
DC	2.729 (69.31)	2.182 (55.42)	2.500 (63.50)	.329 (8.36)	.494 (12.55)	.426 (10.82)	.231 (5.87)	2.272 (57.71)	.422 (10.72)	.060 (1.52)	.039 (0.99)

See *Commerical D Subminiature* catalog for additional Combo D options, including 75 ohm Coax.

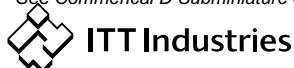

Cannon

Dimensions are shown in inches (millimeters).
Dimensions subject to change.

www.ittcannon.com

Combo D® - Coaxial

Right Angle Printed Circuit Board Hole Patterns

Face view, pin insert
(for receptacle, hole pattern is a mirror image)

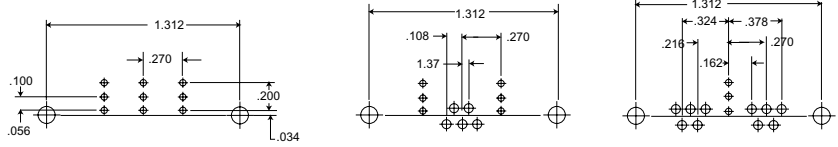
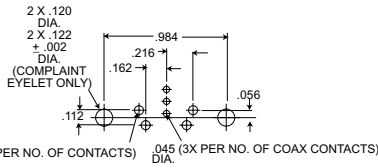

Shell Size **E**
Contact Arrangement **5W1**
No. of Signal Contacts **4 #20**
No. of Coaxial Contacts **1**

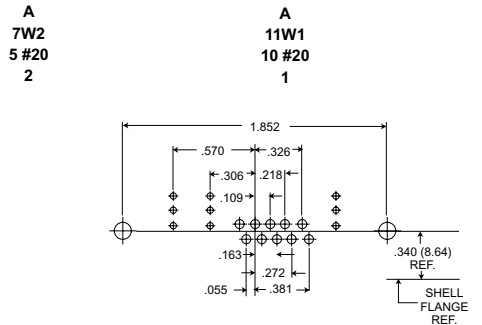
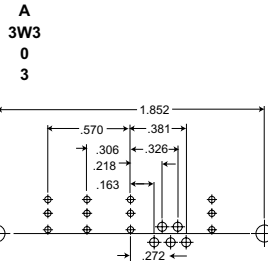
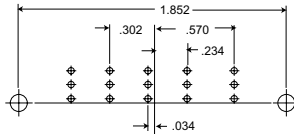

Shell Size **B**
Contact Arrangement **5W5**
No. of Signal Contacts **0**
No. of Coaxial Contacts **5**

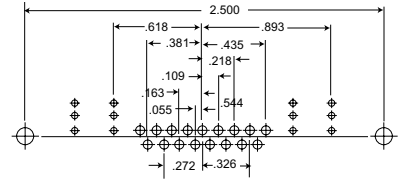
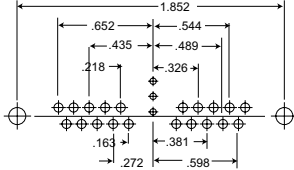
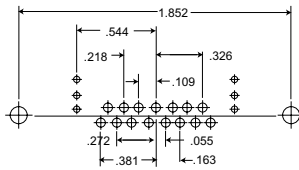

Shell Size **B**
Contact Arrangement **17W2**
No. of Signal Contacts **15 #20**
No. of Coaxial Contacts **2**

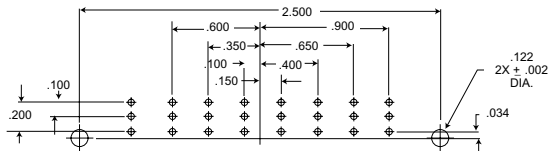

Shell Size **B**
Contact Arrangement **21W1**
No. of Signal Contacts **20 #20**
No. of Coaxial Contacts **1**

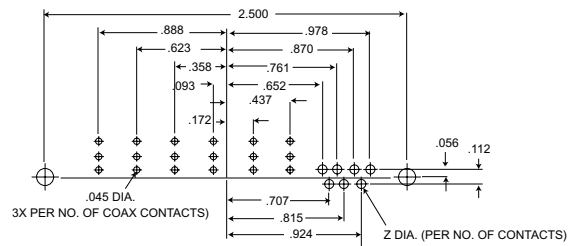

Shell Size **C**
Contact Arrangement **21WA4**
No. of Signal Contacts **17 #20**
No. of Coaxial Contacts **4**

Shell Size **C**
Contact Arrangement **8W8**
No. of Signal Contacts **0**
No. of Coaxial Contacts **8**

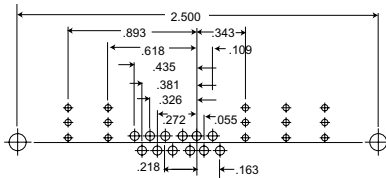

Shell Size **C**
Contact Arrangement **13W6**
No. of Signal Contacts **7 #20**
No. of Coaxial Contacts **6**

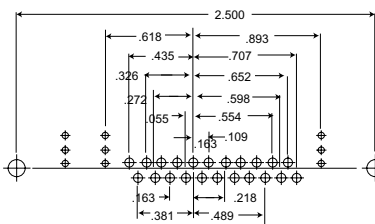

Shell Size **C**
Contact Arrangement **17W5**
No. of Signal Contacts **12 #20**
No. of Coaxial Contacts **5**

Shell Size **C**
Contact Arrangement **25W3**
No. of Signal Contacts **22 #20**
No. of Coaxial Contacts **3**

Size #20 Contact PC Tail Dia.	Z Dia.
.030 (0.76)	.045 (1.14)

See *Commerical D Subminiature* catalog for additional Combo D options, including 75 ohm Coax.

Combo D® - Coaxial/50 Ohm

Straight Receptacle for PCB Mounting



PCB Hole Patterns - Pages 354-355

Part numbers come complete with fixed, female, signal and coaxial contacts.

Layout	Military	NM Non-Magnetic
DE-5W1	DEMM5X1SM	DEM5X1SM-NM-K52
DA-7W2	DAMM7X2SM	DAM7X2SM-NM-K52
DA-11W1	DAMM11X1SM	DAM11X1SM-NM-K52
DA-3W3	DAMM3X3SM	DAM3X3SM-NM-K52
DB-5W5	DBMM5X5SM	DBM5X5SM-NM-K52
DB-9W4	DBMM9X4SM	DBM9X4SM-NM-K52
DB-13W3	DBMM13X3SM	DBM13X3SM-NM-K52
DB-17W2	DBMM17X2SM	DBM17X2SM-NM-K52
DB-21W1	DBMM21X1SM	DBM21X1SM-NM-K52
DC-8W8	DCMM8X8SM	DCM8X8SM-NM-K52
DC-13W6	DCMM13X6SM	DCM13X6SM-NM-K52
DC-17W5	DCMM17X5SM	DCM17X5SM-NM-K52
DC-21WA4	DCMM21XA4SM	DCM21XA4SM-NM-K52
DC-25W3	DCMM25X3SM	DCM25X3SM-NM-K52
DD-24W7	DCMM24X7SM	DCM24X7SM-NM-K52
DC-27W2	DCMM27X2SM	DCM27X2SM-NM-K52
DD-24W7	DDMM24X7SM	DDM24X7SM-NM-K52
DD-36W4	DDMM36X4SM	DDM36X4SM-NM-K52
DD-43W2	DDMM43X2SM	DDM43X2SM-NM-K52
DD-47W1	DDMM47X1SM	DDMC47X1SM-NM-K52

Straight Plug for PCB Mounting (Board Thickness up to .125 [3.18])



PCB Hole Patterns - Pages 354-355

Part numbers come complete with fixed, male, signal and coaxial contacts.

Layout	Military	NM Non-Magnetic
DE-5W1	DEMM5X1PM	DEM5X1PM-NM-K52
DA-7W2	DAMM7X2PM	DAM7X2PM-NM-K52
DA-11W1	DAMM11X1PM	DAM11X1PM-NM-K52
DA-3W3	DAMM3X3PM	DAM3X3PM-NM-K52
DB-5W5	DBMM5X5PM	DBM5X5PM-NM-K52
DB-9W4	DBMM9X4PM	DBM9X4PM-NM-K52
DB-13W3	DBMM13X3PM	DBM13X3PM-NM-K52
DB-17W2	DBMM17X2PM	DBM17X2PM-NM-K52
DB-21W1	DBMM21X1PM	DBM21X1PM-NM-K52
DC-8W8	DCMM8X8PM	DCM8X8PM-NM-K52
DC-13W6	DCMM13X6PM	DCM13X6PM-NM-K52
DC-17W5	DCMM17X5PM	DCM17X5PM-NM-K52
DC-21WA4	DCMM21XA4PM	DCM21XA4PM-NM-K52
DC-25W3	DCMM25X3PM	DCM25X3PM-NM-K52
DC-27W2	DCMM27X2PM	DCM27X2PM-NM-K52
DD-24W7	DDMM24X7PM	DDM24X7PM-NM-K52
DD-36W4	DDMM36X4PM	DDM36X4PM-NM-K52
DD-43W2	DDMM43X2PM	DDM43X2PM-NM-K52
DD-47W1	DDMM47X1PM	DDM47X1PM-NM-K52

Dimensions

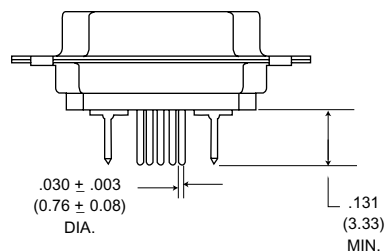

See *Commerical D Subminiature* catalog for additional Combo D options, including 75 ohm Coax.

Combo D® - Coaxial

Straight Printed Circuit Board Hole Patterns

Face view, pin insert
(for receptacle, hole pattern is a mirror image)

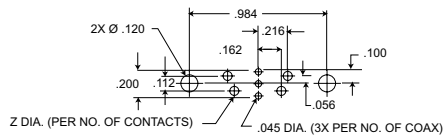

Shell Size **E**
Contact Arrangement **5W1**
No. of Signal Contacts **4 #20**
No. of PC Coaxial Contacts **1**

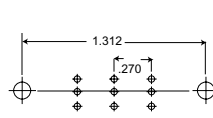

Shell Size **A**
Contact Arrangement **3W3**
No. of Signal Contacts **-**
No. of PC Coaxial Contacts **3**

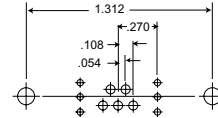

Shell Size **A**
Contact Arrangement **7W2**
No. of Signal Contacts **5 #20**
No. of PC Coaxial Contacts **2**

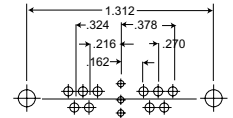

Shell Size **A**
Contact Arrangement **11W1**
No. of Signal Contacts **10 #20**
No. of PC Coaxial Contacts **1**

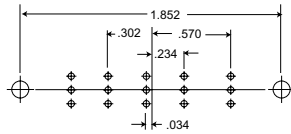

Shell Size **B**
Contact Arrangement **5W5**
No. of Signal Contacts **-**
No. of PC Coaxial Contacts **5**

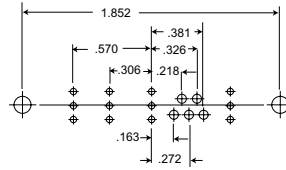

Shell Size **B**
Contact Arrangement **9W4**
No. of Signal Contacts **5 #20**
No. of PC Coaxial Contacts **4**

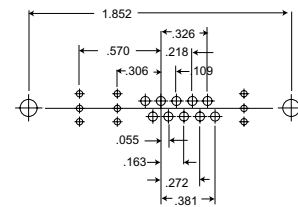

Shell Size **B**
Contact Arrangement **13W3**
No. of Signal Contacts **10 #20**
No. of PC Coaxial Contacts **3**

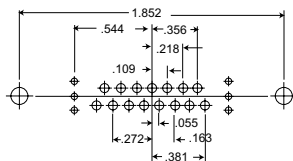

Shell Size **B**
Contact Arrangement **17W2**
No. of Signal Contacts **15 #20**
No. of PC Coaxial Contacts **2**

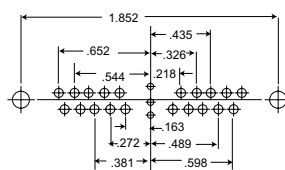

Shell Size **B**
Contact Arrangement **21W1**
No. of Signal Contacts **20 #20**
No. of PC Coaxial Contacts **1**

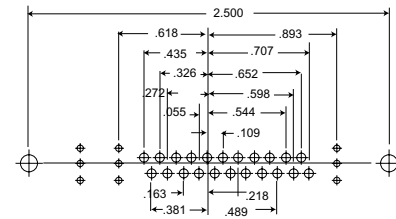

Shell Size **C**
Contact Arrangement **25W3**
No. of Signal Contacts **22 #20**
No. of PC Coaxial Contacts **3**

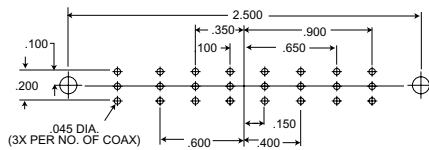

Shell Size **C**
Contact Arrangement **8W8**
No. of Signal Contacts **-**
No. of PC Coaxial Contacts **8**

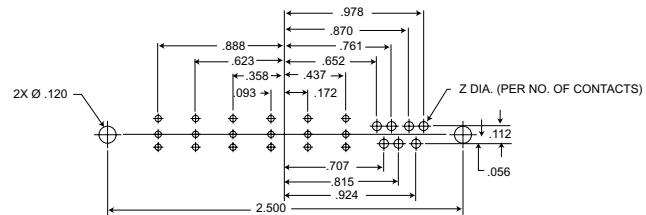

Shell Size **C**
Contact Arrangement **13W6**
No. of Signal Contacts **7 #20**
No. of PC Coaxial Contacts **6**

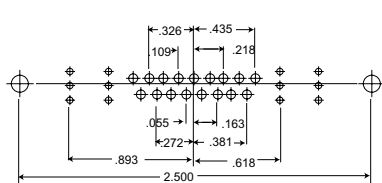

Shell Size **C**
Contact Arrangement **21WA4**
No. of Signal Contacts **17 #20**
No. of PC Coaxial Contacts **4**

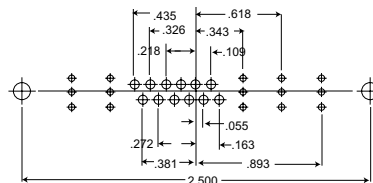

Shell Size **C**
Contact Arrangement **17W5**
No. of Signal Contacts **12 #20**
No. of PC Coaxial Contacts **5**

Size No. 20	2
Contact PC	Dia.
Tail Dia.	.045 (1.14)
	.030 (0.76)

Combo D® - Coaxial

Straight Printed Circuit Board Hole Patterns

Face view, pin insert
(for receptacle, hole pattern is a mirror image)

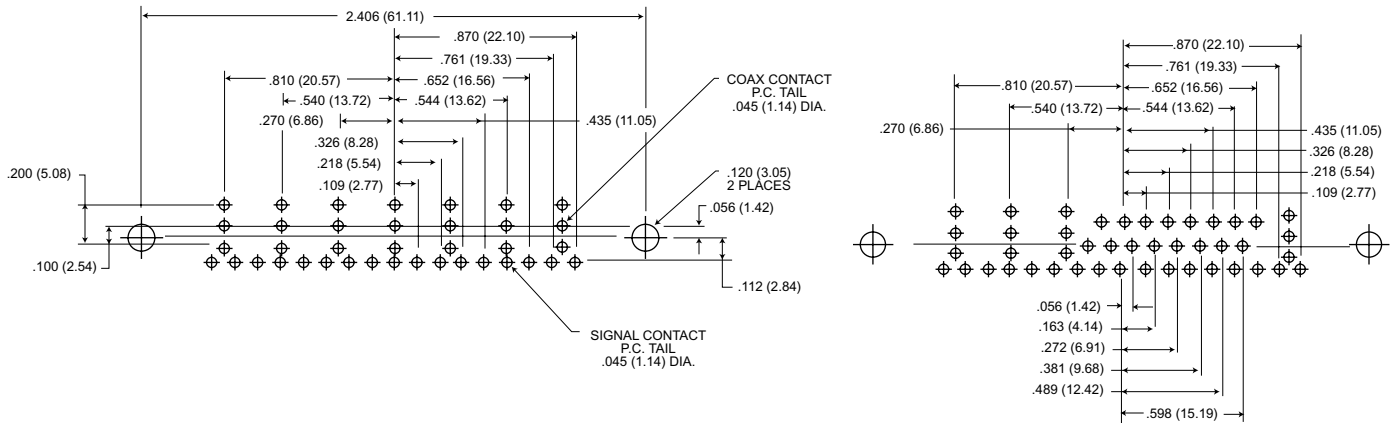

Shell Size **D**
Contact Arrangement **24W7**
No. of Signal Contacts **17 #20**
No. of Coaxial Contacts **7**

Shell Size **D**
Contact Arrangement **36W4**
No. of Signal Contacts **32 #20**
No. of Coaxial Contacts **4**

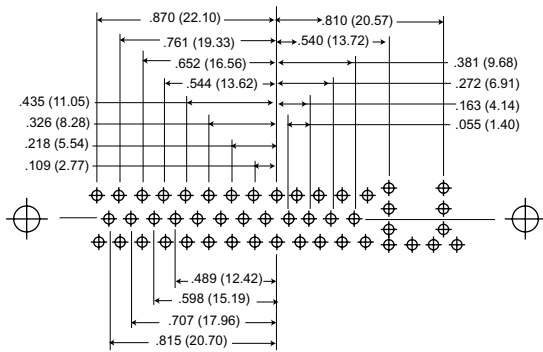

Shell Size **D**
Contact Arrangement **43W2**
No. of Signal Contacts **41 #20**
No. of Coaxial Contacts **2**

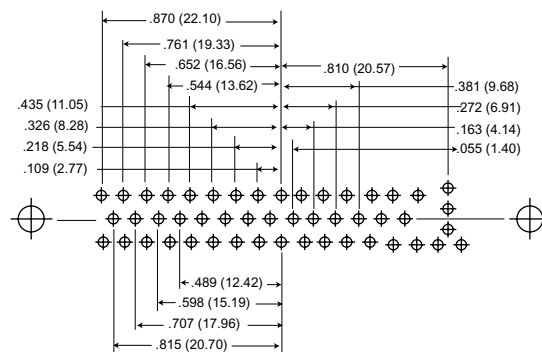

Shell Size **D**
Contact Arrangement **47W1**
No. of Signal Contacts **46 #20**
No. of Coaxial Contacts **1**

Combo D® - High Voltage

Coaxial Housings With Solder Cup Signal Contacts

High voltage contacts supplied separately.



Contact Arrangements: Page 346 of Coax section
Performance Specifications: Page 345 of Coax section.

Clinch Nut and Float Mount Options Available:

Add: E = 4-40 Clinch Nut
Y = Float Mounting

Example: DAMME3W3P
DAMMY3W3P

See page 334 for Mounting Method Detail.

Cable Combinations supplied with preloaded solder signal contacts. High Power Contacts supplied separately, see below.

Extraction Tool for High Power Contacts are the same as for 50 Ohm Coaxial Contacts. See page 348.

Layout	Military Socket	Military Pin	NM - Non-Magnetic Socket	NM - Non-Magnetic Pin
DE-5W1	DEM5W1S	DEM5W1P	DEM5W1S-NMB-K52	DEM5W1P-NMB-K52
DA-7W2	DAMM7W2S	DAMM7W2P	DAM7W2S-NMB-K52	DAM7W2P-NMB-K52
DA-11W1	DAMM11W1S	DAMM11W1P	DAM11W1S-NMB-K52	DAM11W1P-NMB-K52
DA-3W3	DAMM3W3S	DAMM3W3P	DAM3W3S-NMB-K47	DAM3W3P-NMB-K47
DB-5W5	DBMM5W5S	DBMM5W5P	DBM5W5S-NMB-K47	DBM5W5P-NMB-K47
DB-9W4	DBMM9W4S	DBMM9W4P	DBM9W4S-NMB-K52	DBM9W4P-NMB-K52
DB-13W3	DBMM13W3S	DBMM13W3P	DBM13W3S-NMB-K52	DBM13W3P-NMB-K52
DB-17W2	DBMM17W2S	DBMM17W2P	DBM17W2S-NMB-K52	DBM17W2P-NMB-K52
DB-21W1	DBMM21W1S	DBMM21W1P	DBM21W1S-NMB-K52	DBM21W1P-NMB-K52
DC-8W8	DCMM8W8S	DCMM8W8P	DCM8W8S-NMB-K47	DCM8W8P-NMB-K47
DC-13W6	DCMM13W6S	DCMM13W6P	DCM13W6S-NMB-K52	DCM13W6P-NMB-K52
DC-17W5	DCMM17W5S	DCMM17W5P	DCM17W5S-NMB-K52	DCM17W5P-NMB-K52
DC-21WA4	DCMM21WA4S	DCMM21WA4P	DCM21WA4S-NMB-K52	DCM21WA4P-NMB-K52
DC-25W3	DCMM25W3S	DCMM25W3P	DCM25W3S-NMB-K52	DCM25W3P-NMB-K52
DC-27W2	DCMM27W2S	DCMM27W2P	DCM27W2S-NMB-K52	DCM27W2P-NMB-K52
DD-24W7	DDMM24W7S	DDMM24W7P	DDM24W7S-NMB-K52	DDM24W7P-NMB-K52
DD-36W4	DDMM36W4S	DDMM36W4P	DDM36W4S-NMB-K52	DDM36W4P-NMB-K52
DD-43W2	DDMM43W2S	DDMM43W2P	DDM43W2S-NMB-K52	DDM43W2P-NMB-K52
DD-47W1	DDMM47W1S	DDMM47W1P	DDM47W1S-NMB-K52	DDM47W1P-NMB-K52

High Power Contacts

Solder Type

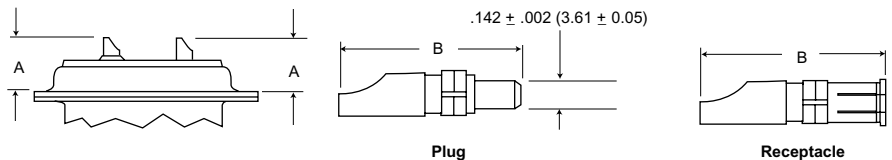

	Gold over Nickel	50µ in. Gold over Copper	NM - Non-Magnetic 50µ in. Gold over Copper	A Max.	B Ref.	Current Rating (Amps)	Wire Size
Plug	DM53745-1	DM53745-28	DM53745-70	.666 (16.92)	.866 (22.00)	40	#8
Plug	DM53745-7	DM53745-27	DM53745-77	.666 (16.92)	.866 (22.00)	20	#12
Plug	DM53745-8	DM53745-25	DM53745-70	.666 (16.92)	.866 (22.00)	10	#16
Receptacle	DM53744-1	DM53744-21	DM53744-62	.666 (16.92)	.856 (21.74)	40	#8
Receptacle	DM53744-6	DM53744-25	DM53744-64	.666 (16.92)	.856 (21.74)	20	#12
Receptacle	DM53744-7	DM53744-24	DM53744-63	.666 (16.92)	.856 (21.74)	10	#16

Crimp Type

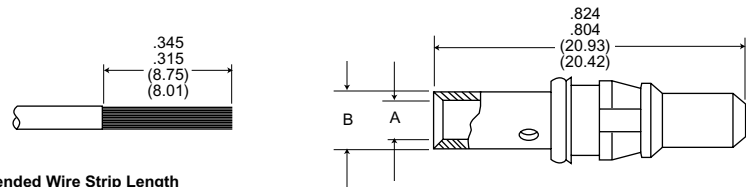

Recommended Wire Strip Length

	Gold over Nickel	50µ in. Gold over Copper	A Dia. Max.	B Dia. Max.	Current Rating (Amps)	Wire Size
Plug	DM130338-4	DM130338	.181 (4.60)	.230 (5.84)	40	#8
Plug	DM130339-4	DN130339	.100 (2.54)	.218 (5.54)	20	#12
Plug	DM130340-4	DM130340	.067 (1.07)	.102 (2.59)	10	#16
Receptacle	DM130341-4	DM130341	.181 (4.60)	.230 (5.84)	40	#8
Receptacle	DM130342-4	DM130342	.100 (2.54)	.218 (5.54)	20	#12
Receptacle	DM130343-4	DM130343	.067 (1.07)	.102 (2.59)	10	#16

Crimp Tooling - Page 357.

See Commercial D Subminiature catalog for PCB High Power connectors.



Cannon

Dimensions are shown in inches (millimeters).
Dimensions subject to change.

www.ittcannon.com

Combo D® - High Power

Crimp High Power Contact Tooling

(For use with Crimp High Power Contacts on Page 356)

AWG Wire Size	Daniels Crimp Tool	Crimp Tool/Locator	
		Tool Setting Number	Locator
8-10	M300-BT	AWG 8 = 6 AWG 10 = 5	TP968
12-14	M300-BT	AWG 12/14 = 1	TP968
16-18	FT-8	AWG 16 = 6 AWG 18 = 5	TH554

NOTE: Purchase tooling directly from Daniels.

Combo D Guide Pin and Socket

Installs into any Combo D, size 8 Cavity. This patented guide pin and socket system is ideal for blind mate applications where space is limited.

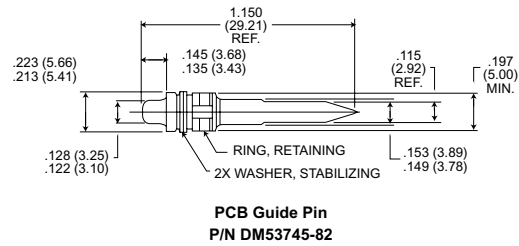
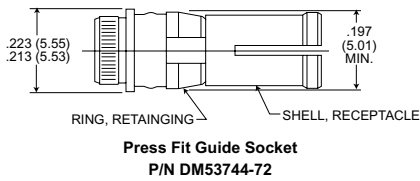

Description	Material	Finish
Guide Pin	Brass	Gold over nickel
Guide Socket	Copper Alloy	Gold over nickel

Combo D® - High Voltage

Coaxial Housings With Solder Cup Signal Contacts

High voltage contacts supplied separately.



Contact Arrangements: Page 346 of Coax section
Performance Specifications: Page 345 of Coax section.

Clinch Nut and Float Mount Options Available:

Add: E = 4-40 Clinch Nut
Y = Float Mounting

Example: DAMME3W3P
DAMMY3W3P

Mouting Method Detail - Page 334.

Cable Combinations supplied with preloaded solder signal contacts. High Voltage Contacts supplied separately, see below.

Extraction Tool for High Voltage Contacts are the same as for 50 Ohm Coaxial Contacts. See page 348.

Layout	Military Socket	Military Pin
DE-5W1	DEMM5W1S	DEMM5W1P
DA-7W2	DAMM7W2S	DAMM7W2P
DA-11W1	DAMM11W1S	DAMM11W1P
DA-3W3	DAMM3W3S	DAMM3W3P
DB-5W5	DBMM5W5S	DBMM5W5P
DB-9W4	DBMM9W4S	DBMM9W4P
DB-13W3	DBMM13W3S	DBMM13W3P
DB-17W2	DBMM17W2S	DBMM17W2P
DB-21W1	DBMM21W1S	DBMM21W1P
DC-8W8	DCMM8W8S	DCMM8W8P
DC-13W6	DCMM13W6S	DCMM13W6P
DC-17W5	DCMM17W5S	DCMM17W5P
DC-21WA4	DCMM21WA4S	DCMM21WA4P
DC-25W3	DCMM25W3S	DCMM25W3P
DC-27W2	DCMM27W2S	DCMM27W2P
DD-24W7	DCMM24W7S	DCMM24W7P
DD-36W4	DCMM36W4S	DCMM36W4P
DD-43W2	DCMM43W2S	DCMM43W2P
DD-47W1	DCMM47W1S	DCMM47W1P

High Voltage Combination Contacts

Wire Accommodation (AWG)	#20 Max.
Current Rating	5 Amp
Temperature Rating	-55°C to +125°C

Description	Material	Finish
Contacts	Copper Alloy	Std: Gold over nickel MIL-50μ in. Gold over copper
Insulator	Thermoplastic	None
Ring, Retaining	Copper Alloy	Nickel

Straight

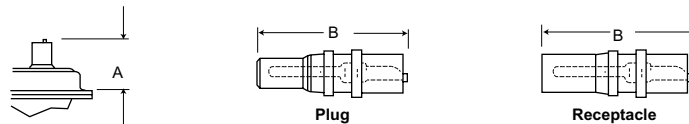

	Gold over Nickel	50μ in. Gold	A Max.	B Ref.	Wire Size
Plug	DM51157	DM51157-8	.539 (13.69)	.734 (18.64)	#20
Receptacle	DM51155	DM51155-7	.539 (13.69)	.764 (19.41)	#20

Right Angle

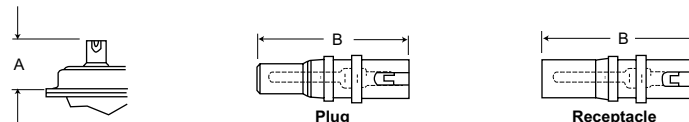

	Gold over Nickel	50μ in. Gold	A Max.	B Ref.	Wire Size
Plug	DM51157-5000	DM51157-5005	.491 (12.47)	.697 (17.70)	#20
Receptacle	DM51155-5000	DM51155-5004	.491 (12.47)	.697 (17.70)	#20

Straight PCB

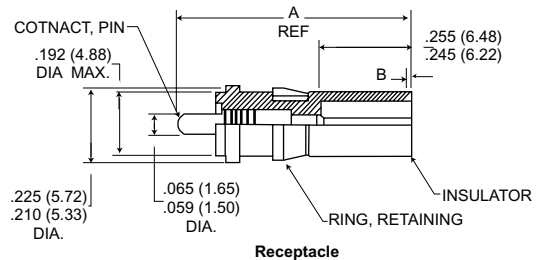
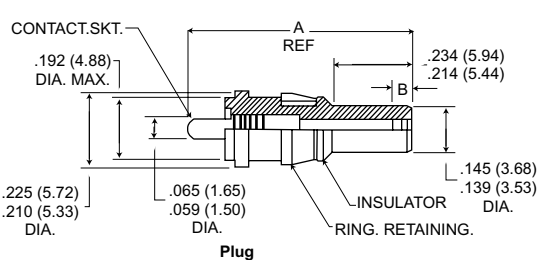

	Standard Finish	Military Finish	A	B
Plug	DM51157-13	DM51157-14	.628 (15.95)	.060/.050 (1.52/1.27)
Receptacle	DM51155-12	DM51155-13	.660 (16.76)	.010/.000 (0.25/0.00)



The Cannon D*D Environmental Series is designed to meet the demand for sealed subminiature rectangular plugs with superior vibration and moisture resistance characteristics for aircraft, missile, and ground support equipment applications.

Featuring a rugged aluminum shell and peripheral seal, the D*D connector meets all applicable requirements of MIL-C-24308. Available in both sol-

der and crimp versions, all assemblies are provided with nylon potting cups and dust caps.

Solder type contacts are non-removable and are factory-installed. Crimp type connectors utilize the field-proven LITTLE CAESAR® rear insertion, rear-release retention system.

PLEASE NOTE: The D*D Series is not interchangeable with other D Subminiature connectors.

Performance and Material Specifications

Shell	Aluminum, cadmium plated with yellow chromate supplementary coating.
Contacts	Solder pot: Copper alloy, gold plated .00002 (0.0005) over nickel .00004 (0.0010). Crimp type: Copper alloy, gold plated .00002 (0.0005) over nickel .00004 (0.0010)
Insulator	Diallyl phthalate, per MIL-M-14, Type MDG or SDG-F
Contact Termination	Solder pot accommodating up to #20 AWG stranded wire. Crimp type accommodating #20, #22 and #24 AWG stranded wire.
Socket Type	Closed entry
Float Mounting Rivets & Washers	Stainless steel Passivated per QQ-P-35

Test Data

Specifications	
Voltage Rating	All voltage figures are AC (rms). 60 Hz measured at approximately 25.0°C 50% RH
Insulation Resistance (per MIL-C-24308)	Greater than 5,000 megohms, determined in accordance with MIL-STD-202A, Method 302.
Contact Voltage Drop	2.67 millivolts, maximum, per amp.
Contact Separation Force	1 to 8 ounces when tested in accordance with MIL-C-24308.
Air Leakage	When properly wired and potted, 1 cubic inch of air per hour max. when subjected to 30 PSI pressure differential in accordance with MIL-C-5015D, Paragraph 4.5.3.1
Vibration (per MIL-C-24308)	Exceeds test requirements of MIL-STD-202A, Method 204, Condition D.
Corrosion Resistance (per MIL-C-24308)	Exceeds requirements of 50 hour exposure to salt spray in accordance with MIL-STD-202A, Method 101A, Condition B.
Moisture Resistance (per MIL-C-24308)	Exceeds requirements of MIL-STD-202A, Method 106.
Shock	Exceeds requirements of MIL-STD-202A, Method 213, Condition G
Environmental Seal	Effective from full engagement to 1/16 short of full engagement.
Contact Retention Force	(Crimp type) 8 pounds (35.6 newtons) minimum of first cycles: 5 pounds (22.2 newtons) minimum after tenth cycle.
Standard Layout Plugs	Measured from contact-to-contact, and contact-to-shell or unmated condition.

	ALTITUDE (FEET)			
	Sea Level	20,000	50,000	70,000
Average Flash-over	1700	1000	650	500
Test	1250	750	475	375

See *Commercial D Subminiature* catalog for additional Combo D options, including 75 ohm Coax.

How to Order

Solder Cup Terminals



SERIES PREFIX

ITT Cannon Designation

SHELL SIZE

A, B, C, D, E

CLASS

D - Environmental

CONTACT ARRANGEMENT

9, 15, 25, 37, 50

CONTACT TYPE

P - Pin
S - Socket

MOUNTING STYLE

A - Standard mounting holes
B - Float mounts supplied

MODIFICATION

Consult factory

Snap-In Crimp Terminals

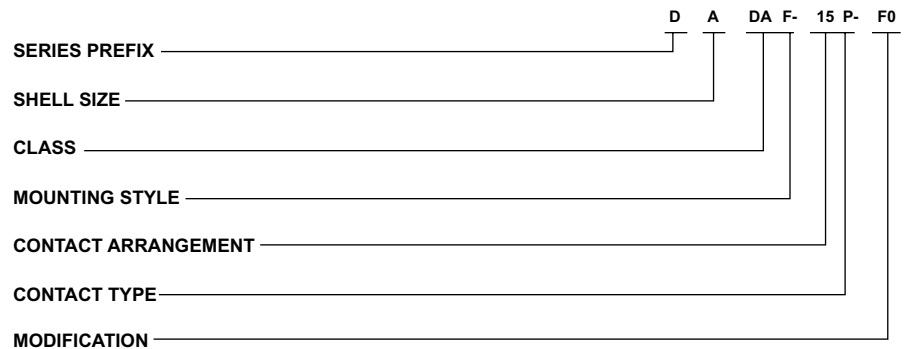

SERIES PREFIX

ITT Cannon Designation

SHELL SIZE

A, B, C, D, E

CLASS

DA - Environmental, crimp type

MOUNTING STYLE

No Designator - Standard mounting
F - Float mounts supplied

CONTACT ARRANGEMENT

9, 15, 25, 37, 50

CONTACT TYPE

P - Pin
S - Socket

MODIFICATION

F0 - Connector supplied less contacts, for other modifications consult factory.

Contact Arrangements

Faces View Pin Insert

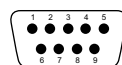

E
9
#20

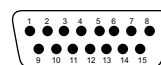

A
15
#20

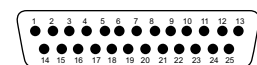

B
25
#20

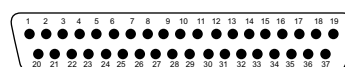

C
37
#20

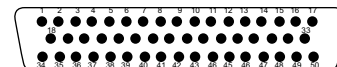

D
50
#20

Shell Size
Contact Arrangement
Contact Size

Shell Size
Contact Arrangement
Contact Size

Shell Dimensions, Standard Mount

Receptacle

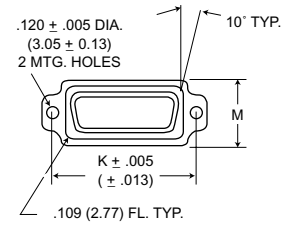
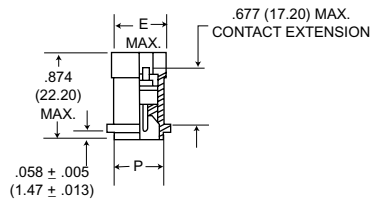
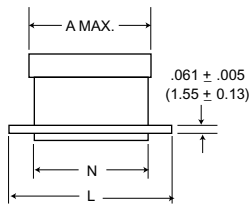

Plug

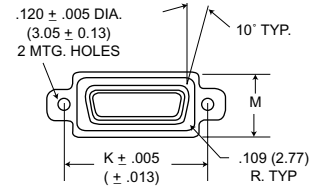
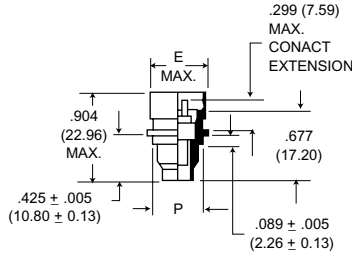
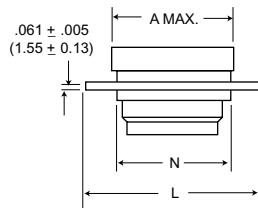

Float Mount Dimensions

Receptacle

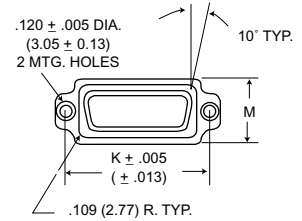
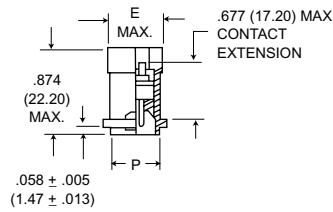
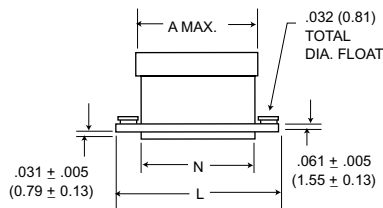

Plug

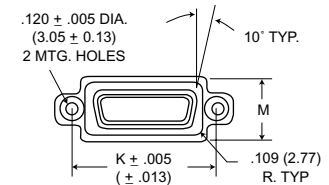
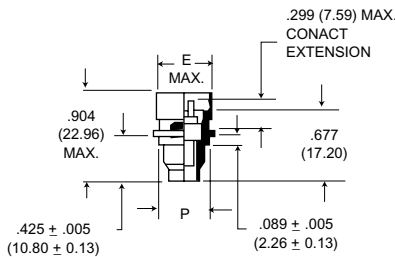
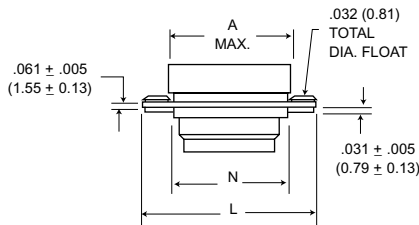

NOTE: All D*D Environmental plugs and receptacles are provided with dust caps and removable potting cups.

Shell Size	A Max.	E Max.	K ± .005 (0.13)	L ± .010 (0.25)	M ± .010 (0.25)	N ± .010 (0.25)	P ± .010 (0.25)
DED-9P	.915 (23.24)	.596 (15.14)	1.125 (28.58)	1.442 (36.63)	.614 (15.60)	.825 (20.86)	.483 (12.27)
DED-9S	.915 (23.24)	.596 (15.14)	1.125 (28.58)	1.442 (36.63)	.614 (15.60)	.825 (20.86)	.483 (12.27)
DAD-15P	1.233 (31.32)	.596 (15.14)	1.437 (36.50)	1.755 (44.58)	.614 (15.60)	1.143 (29.03)	.483 (12.27)
DAD-15S	1.233 (31.32)	.596 (15.14)	1.437 (36.50)	1.755 (44.58)	.614 (15.60)	1.143 (29.03)	.483 (12.27)
DBD-25P	1.786 (45.36)	.596 (15.14)	1.993 (50.62)	2.295 (58.29)	.614 (15.60)	1.683 (42.75)	.483 (12.27)
DBD-25S	1.786 (45.36)	.596 (15.14)	1.993 (50.62)	2.295 (58.29)	.614 (15.60)	1.683 (42.75)	.483 (12.27)
DCD-37P	2.458 (62.43)	.567 (14.40)	2.625 (66.68)	2.937 (74.60)	.614 (15.60)	2.343 (59.51)	.483 (12.27)
DCD-37S	2.458 (62.43)	.567 (14.40)	2.625 (66.68)	2.937 (74.60)	.614 (15.60)	2.343 (59.51)	.483 (12.27)
DDD-50P	2.390 (60.71)	.680 (17.27)	2.531 (64.29)	2.859 (72.62)	.735 (18.67)	2.251 (57.18)	.596 (15.14)
DDD-50S	2.390 (60.71)	.680 (17.27)	2.531 (64.29)	2.859 (72.62)	.735 (18.67)	2.251 (57.18)	.596 (15.14)

All tolerances are ± .010 (0.24) unless noted otherwise.

Mounting Dimensions

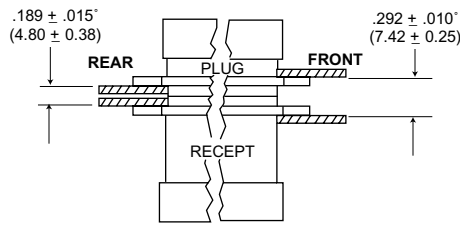

Figure 1

Figure 2

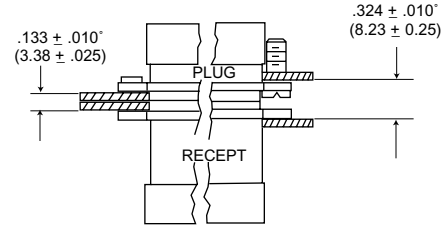

Figure 3

Figure 4

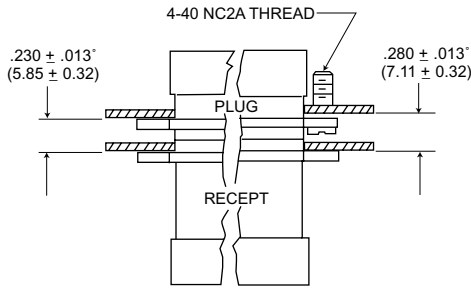

Figure 5

Figure 6

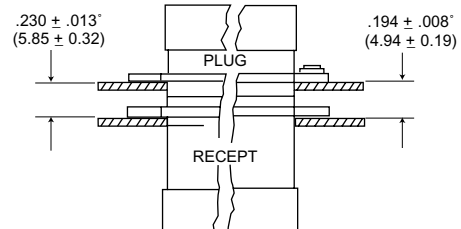

Figure 7

Figure 8

NOTE: Max panel thickness is .125 (3.17) for non-floating rear panel mounting.

1. With both connectors rear mounted, use #4-40 flat head screws flush with the panel (Fig. 1).
2. With both connectors front mounted, use #4-40 binder or pan head screws (Fig. 2).
3. With both connectors rear mounted (float rivets on plug assembly side); use #4-40 flat head screws, flush with the panel (Fig. 3).
4. With both connectors front mounted (plug assembly has float mounting screw), use #4-40 binder or pan head screws for receptacle assembly (Fig. 4)

5. With plug assembly front mounted and receptacle assembly rear mounted, use hardware from Figures 5 and 6.
6. With plug assembly front mounted and receptacle assembly rear mounted (plug assembly has float mounting screw), use hardware from figure 1 for receptacle assembly.
* Dimensions between panels represent the recommended limit to be used in the design of the connector mounting method.
7. With plug assembly rear mounted and receptacle assembly front mounted, use hardware from Figures 1 and 2.

8. With plug assembly rear mounted (float rivets) and receptacle assembly front mounted, use hardware from Figures 2 and 3.
9. Electrical contact engagement when mounted per Figure 1 is .046 (1.17) min./0.070(1.78) max.

NOTE: Float rivets are for rear mounting only and float screw for front mounting only. (Specify when ordering.)

Panel Cutouts

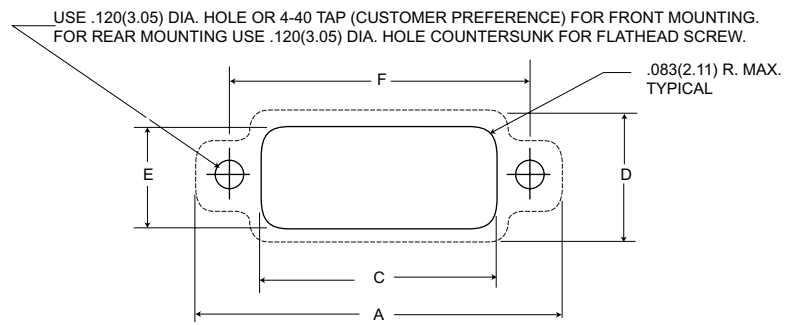

Shell Size	A + .010 (0.25)	C Min.	D ± .010 (0.25)	E Min.	F + .006 (0.15)
DED-9	1.442 (36.63)	.839 (21.31)	.614 (15.60)	.497 (12.62)	1.125 (28.58)
DAD-15	1.755 (44.58)	1.157 (29.39)	.614 (15.60)	.497 (12.62)	1.437 (36.50)
DBD-25	2.295 (58.29)	1.697 (43.10)	.614 (15.60)	.497 (12.62)	1.993 (50.62)
DCD-37	2.937 (74.60)	2.357 (59.87)	.614 (15.60)	.497 (12.62)	2.625 (66.68)
DDD-50	2.859 (72.62)	2.265 (57.53)	.735 (18.67)	.610 (15.49)	2.531 (64.29)

Add .032 (0.81) to dimensions C and E for float mounting.
Note: Panel cutout does not allow for potting cup clearance.

Contact Crimping Information

Crimp Type Contacts

Contact Size	Wire Size Accom.	Standard Finish		Military Finish	
		Pin	Socket	Pin	Socket
20	20, 22, 24	330-5291-015	031-1007-000	330-5291-079	031-1007-042

Semi-Automatic Crimp Machines

Insertion/Extraction Tools

CIET-20HD

Contact Size	AWG	Plastic Insertion/Extraction		Plastic Extraction	
		Part No.	Description	Part No.	Description
20	20, 22, 24	980-2000-426	CIET-20HD	323-7010-000	CET-20-11

CBT-646

The CBT-646, Vibra-Bowl Crimper is a pneumatically powered, electronically controlled machine. It is designed to semi-automatically crimp closed barrel, machined contacts, as used in the aerospace and commercial industries. The machine will accommodate wire sizes 30 thru 12 AWG. The CBT-646 is actuated automatically upon insertion of a pre-stripped stranded or single conductor wire. The CBT-646 meets all Mil. Spec. requirements for crimping closed barrel contacts.



Hand Crimp Tools

M22520/1-01

M22520/2-01

Contact Size	AWG	Crimp Tool		Locator	
		Part No.	Description	Part No.	Description
20	20, 22, 24	995-0001-584	M22520/2-01	995-0001-604	M22520/2-08
		995-0001-585	M22520/1-01	995-0001-244	TH25

Machine Crimp Rate: 1300 + per hour

Power Requirements:

Electrical = 115 Vac, 60 Hz, 5A

Pneumatic = 85 psi, 2 cu. ft. per min.

Products: Most ITT Cannon Commercial and Aerospace closed-barrel contacts, wire sizes 30 thru 12 AWG. See connector line for part numbers.

Assembly Instructions

Wire Stripping-Machined Contacts

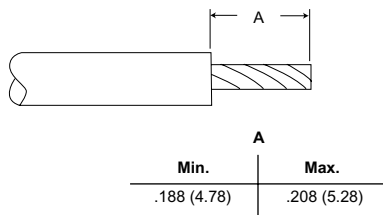

1. Cut wires to length. Strip insulation per above illustration. Check for broken or frayed wires.

Contact Crimping



2. Insert contact and wires into paper crimp tool (and locator, if required). Crimp contact to wires. Inspect crimp.

Contact Insertion



3. Center wired contact in groove of insertion tool with tool tip butting contact shoulder. Insert contact into cavity until a positive stop is felt. Inspect insertion.



4. To be sure contact is locked securely, pull back lightly on wire. Repeat for balance of contacts working row by row across the insulator.

Contact Extraction



5. Place wire into extraction tool tip.



6. Insert tool tip into contact cavity until tip bottoms against contact shoulder, releasing tines. Hold wires against tool with finger and remove tool and contact. Repeat for balance of contacts.



- Environmental Protection
- MIL-C-24308 Compatibility
- Reliability and Versatility

GD* connectors are ideal for aerospace, military, telecommunications and other applications requiring environmental protection and high reliability.

ITT Cannon developed GD* connectors to meet the needs of the avionics industry. These connectors provide high-density and moisture protection.

Environmental protection is accomplished by the resilient grommet, interfacial seal, and bonded connector components.

Performance and Material Specifications

MATERIALS AND FINISHES

	Materials	Finishes
Shell	Low carbon steel per ASTM-A-620	Yellow chromate over cadmium per QQ-P-416, Type II, Class 2
Insulator	Diallyl phthalate per MIL-M-14 type SDF-F or GDI-30F	-
Contacts	Copper alloy	Standard finish: Gold over nickel Military Finish: Gold 50 microinches thickness per MIL-G-45204, Type II, Grade C, Class 1, over copper per MIL-C-14550
Float Mount Hardware	Stainless steel	Passivated per QQ-P-35
Grommets and Seals	Silicone elastomer or Fluorosilicone	
Bonding Materials	Epoxy	-

MECHANICAL FEATURES

Wire Accommodation - Contact: #20, #22, #24 AWG.

Wire O.D. .071 (1.80) maximum, .038 (0.97) minimum.

Contact Retention - 9 lbs. minimum (40n) after 10 insertions.

ELECTRICAL DATA

Test Voltage AC RMS 60 Hz

	Sea Level	20,000 Ft.	50,000 Ft.	70,000 Ft.
Average Flashover	1,000	1,000	500	500
Test	1,000	650	325	325

Maximum Current Carrying Capacity of Contacts - #20 Contacts: 5 Amps

Temperature Range - -65°C to +150°C (-53.9°F to +302°F)

How to Order

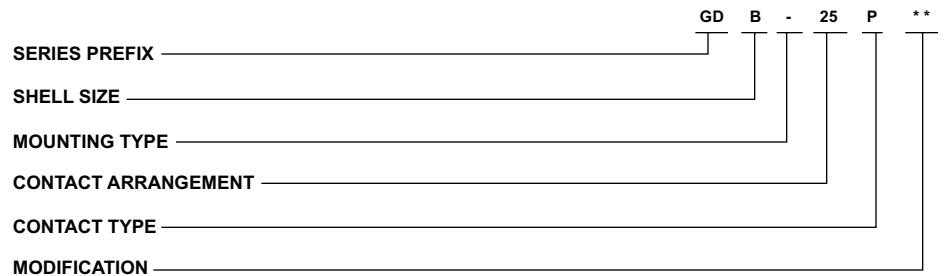

SERIES PREFIX
GD - Grommet D

SHELL SIZE
E, A, B, D

MOUNTING TYPE
No Designator - .120 (3.05) Diameter Mounting Holes
Y - Float Mount for Rear and Front Panel Mounting

CONTACT ARRANGEMENT
9, 15, 25, and 50

CONTACT TYPE
P - Pin, crimp termination
S - Socket, crimp termination
PB - Pin, Printed circuit termination with non-removable straight tails for .125 (3.18) maximum P.C. Board thickness

MODIFICATIONS (Typical Modifiers)
F0 - Connectors supplied Less Contacts
A156 - Connectors supplied with contacts plated per MIL-G-45204 Type II Class 1 over copper per MIL-C-14550 (M24308 Finish)

Test Data

GD* connectors meet all applicable requirements of MIL-C-24308. The following are excerpts from ITT Cannon Test Report C82-78 applicable to environmental D subminiature GD* series connectors. Refer to MIL-C-24308 Test Extracts on page 385.

Test Description	Test Method	Results
Moisture Resistant	MIL-STD-1344 Method 1002.1 Type II	1. No deterioration of performance. 2. Insulation resistance greater than 100 megohms 3. No evidence of flashover or breakdown during 1000 VAC DWV testing.
Fluid Immersion	20 hours immersion in hydraulic fluid per MIL-H-5606 and lubricating fluid per MIL-L-23699	1. No detrimental damage. 2. Able to meet requirements of mating and unmating forces test.
Immersion	Two hour Immersion tap water at a dept of 36.00 (914.40) in mated condition, per MIL-STD-810 Method 512, Procedure 1.	While still immersed, the mated connectors exceeded 100 megohm insulator resistance and exhibited no evidence of breakdown or flashover during 1000 VAC (RMS) DWV testing.

Design Features

- Resilient silicone grommets for wire sealing
- Interfacial seals
- Closed-entry socket contacts
- Bonded components to prevent moisture
- Optional sealing plugs
- Uses M39029 type contacts and termination tooling
- Intermateable with most M24308 type connectors
- Rear-release crimp contacts
- LITTLE CAESAR® contact retention assembly

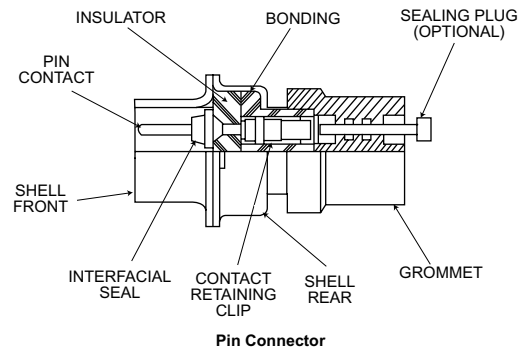
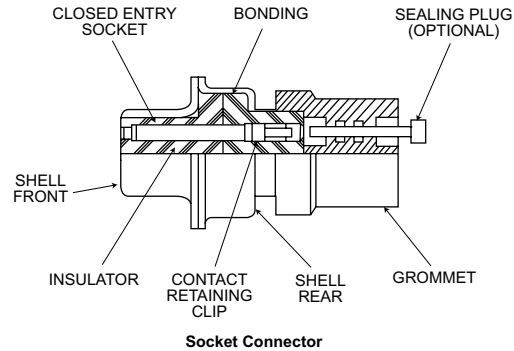

Printed Circuit Applications

GD* pin connectors are available with pre-loaded, non-removable contacts for P.C. board termination. Typical Part No. GDB-25PB. Environmental sealing is accomplished by application of epoxy to each contact cavity, interfacial seals, and bonded connector components.

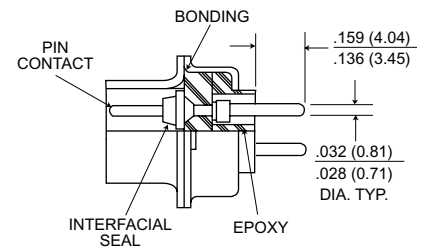

Standard Shell Dimensions

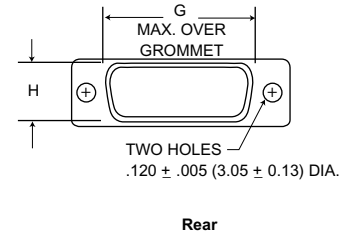
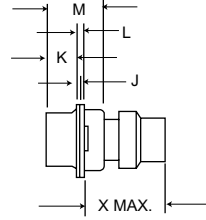
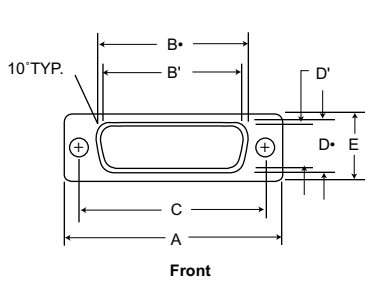

Shell With Float Mount Dimensions

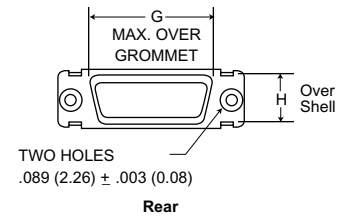
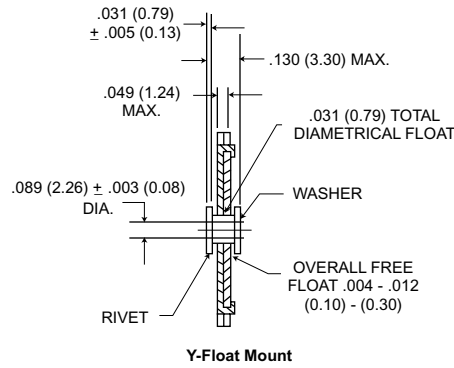
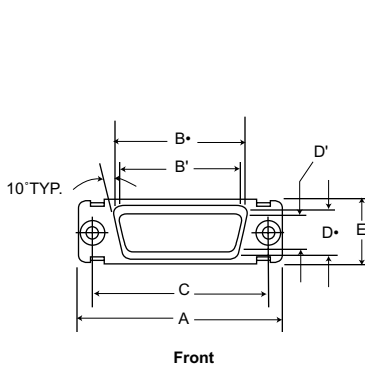

It is recommended that only one assembly, either pin or socket, be float mounted. For front panel mounting use reverse float mount.

Shell Size	A ± .015 (0.38)	B* ± .005 (0.13)	B' ± .005 (0.13)	C ± .005 (0.12)	D* ± .005 (0.13)	D' ± .005 (0.13)	E ± .015 (0.38)	G Max.	H ± .010 (0.25)	J ± .010 (0.25)	K ± .006 (0.13)	L ± .010 (0.25)	M ± .005 (0.13)	X Max.
GDE-9P	1.213 (30.81)	-	.666 (16.91)	.984 (24.99)	-	.329 (8.36)	.494 (12.55)	.750 (19.05)	.422 (10.72)	.030 (0.76)	.235 (5.97)	.045 (1.14)	.422 (10.72)	.718 (18.24)
GDE-9S	1.213 (30.81)	.643 (16.33)	-	.984 (24.99)	.311 (7.90)	-	.494 (12.55)	.750 (19.05)	.422 (10.72)	.030 (0.76)	.243 (6.17)	.045 (1.14)	.429 (10.90)	.718 (18.24)
DGA-15P	1.541 (39.14)	-	.994 (25.24)	1.312 (33.32)	-	.329 (8.36)	.494 (12.55)	1.093 (27.76)	.422 (10.72)	.030 (0.76)	.235 (5.97)	.045 (1.14)	.422 (10.72)	.718 (18.24)
GDA-15S	1.541 (39.14)	.971 (24.66)	-	1.312 (33.32)	.311 (7.90)	-	.494 (12.55)	1.093 (27.76)	.422 (10.72)	.030 (0.76)	.243 (6.17)	.045 (1.14)	.429 (10.90)	.718 (18.24)
GDB-25P	2.088 (53.03)	-	1.534 (38.96)	1.852 (47.04)	-	.329 (8.36)	.494 (12.55)	1.625 (41.28)	.422 (10.72)	.039 (0.99)	.230 (5.84)	.060 (1.52)	.426 (10.82)	.718 (18.24)
GDB-25S	2.088 (53.03)	1.511 (38.38)	-	1.852 (47.04)	.311 (7.90)	-	.494 (12.55)	1.625 (41.28)	.422 (10.72)	.030 (0.76)	.243 (6.17)	.045 (1.14)	.429 (10.90)	.718 (18.24)
GDD-50P	2.635 (66.92)	-	2.079 (52.81)	2.406 (61.11)	-	.441 (11.20)	.605 (15.37)	2.162 (54.91)	.534 (13.56)	.039 (0.99)	.230 (5.84)	.060 (1.52)	.426 (10.82)	.718 (18.24)
GDD-50S	2.635 (66.92)	2.064 (52.42)	-	2.406 (61.11)	.423 (10.74)	-	.605 (15.37)	2.162 (54.91)	.534 (13.56)	.030 (0.76)	.243 (6.17)	.045 (1.14)	.429 (10.90)	.718 (18.24)

* dimensions B, D, and H are measured as outside dimensions at the bottom of draw.

NOTE: B* and D* are the outside dimensions for socket side, B' and D' are the inside dimensions for pin side.

Contact Arrangements

Face View Pin Insert

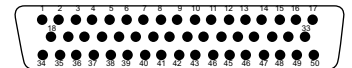
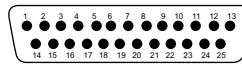
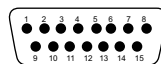
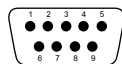

Shell Size
Contact Arrangement
Contact Size

E
9
#20

A
15
#20

B
25
#20

D
50
#20

Contacts

Finish	Type	ITT Cannon Part Number	M39029 Part Number
Standard	Pin #20	330-5291-000	
Gold/Nickel	Socket #20	031-1007-000	
A156	Pin #20	330-5291-037	M39029/64-369
Gold/Copper	Socket #20	031-1007-042	M39029/63-368

Accessories

SEALING PLUGS: GD* grommets are designed to accept MS27488-20 sealing plugs, ITT Cannon P/N 225-0070-000 ordered separately.

LOCKING HARDWARE, DUST CAPS: GD* Connectors will accommodate most standard D Subminiature accessories.

Hand Crimp Tool

M22520/2-01 with M22520/2-08 locator. Semi-automatic and fully automatic tooling is also available.



Insertion/Extraction Tool (Plastic)

Contact Size	ITT Cannon Description	ITT Cannon Part Number	Insertion Color Tip	Extraction Color Tip
#20	CIET-20HDL	274-7010-000	White	Green

D Subminiature Accessories

ITT Cannon offers one of the broadest lines of accessories for the D Subminiature line of connectors in today's marketplace. The ITT Cannon accessory line offers unlimited design versatility. Choose from a variety of plastic, metal, EMI/RFI backshells, screwlocks, jackscrews, and spring latches.

Backshell/Hardware Compatibility Chart

		Locking Hardware								
		Male Screw Locks 020419/ 020420	Female Screw-Locks D20418	Jack-screw D110550	Jack-post D110551	Slide Locks DA51220-1 thru DE51224-1	Slide Lock Post D53018	Spring Latch D110277/ D110279	Spring Latch Plate D110279/ D110280	Keying Plate
MOUNTING METHOD	Front Panel		•		•	•	•	•		•
	Rear Panel		•			•	•	•		
METAL BACKSHELLS	Deep Straight Clamp	•	•		•	•	•	•	•	•
	Right Angle		•			•	•	•	•	•
	Round Clamp	•	•		•	•	•	•	•	•
	Straight Clamp	•	•		•	•	•	•	•	•
SHIELDED BACKSHELLS	Plated Plastic									
	Die-Cast Zinc									
PLASTIC BACKSHELLS	Straight & 90° (D*5121X)					•	•	•	•	•
	Universal D*110963	•	•	•	•			•	•	
	Snap-Together Universal	•	•	•	•			•	•	
	Dataphone DB51226-1B	Supplied with male screw locks.								
	IDC D*115386 STR/90° D*115339	Designed for use with quick-disconnect latching hardware (see page 376).								
POTTING CUPS	Plastic	•	•		•	•	•	•	•	•

Legend: • = Compatible

Accessories - M85049 Backshells

Deep Straight Clamp

- Positive strain relief

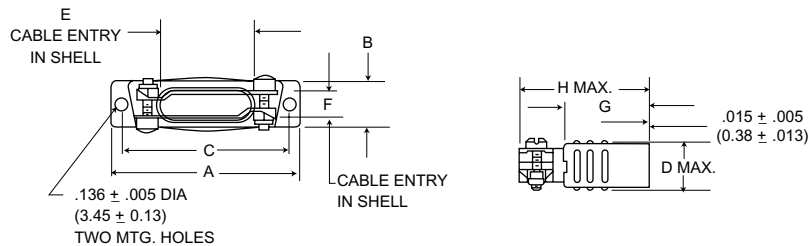

MIL-Spec.

Material: Low Carbon Steel per ASTM A-620

Finish: Yellow Chromate Over Cadmium per M85049 Specification

Non-Magnetic/No-Outgas*

Material: Brass per QQ-B-613

Finish: Gold over copper per MIL-G-45204, Type II, Grade C, Class 1 or Electroless nickel per MIL-C-26074B

(Superseded MIL-Spec. No.: M24308/20-1 thru-5)

Layout	Part Number	Mil. Spec.	Plating		A ± .015 (0.38)	B ± .015 (0.38)	C ± .005 (0.13)	D Max.	E ± .015 (0.38)	F ± .015 (0.38)	G ± .015 (0.38)	H Max.
			AU	NI								
DE-9	DE24657	M85049/48-1-1	DE24657	-16 -27	1.203 (30.6)	.484 (12.3)	.984 (25.0)	.578 (14.7)	.375 (9.5)	.375 (9.5)	7.50 (19.0)	1.250 (31.7)
DA-15	DA24658	M85049/48-1-2	DA24658	-15 -25	1.531 (38.9)	.484 (12.3)	1.312 (33.3)	.578 (14.7)	.713 (18.1)	.312 (7.9)	7.50 (19.0)	1.250 (31.7)
DB-25	DB24659	M85049/48-1-3	DB24659	-15 -25	2.078 (52.8)	.484 (12.3)	1.852 (47.0)	.578 (14.7)	1.000 (25.4)	.312 (7.9)	1.000 (25.4)	1.563 (39.7)
DC-37	DC24660	M85049/48-1-4	DC24660	-16 -25	2.718 (69.0)	.484 (12.3)	2.500 (63.5)	.578 (14.7)	1.375 (34.9)	.312 (7.9)	1.000 (25.4)	1.563 (39.7)
DD-50	DD24661	M85049/48-1-5	DD24661	-13 -23	2.625 (66.7)	.593 (15.1)	2.406 (61.1)	.687 (17.4)	1.406 (35.7)	.406 (10.3)	1.125 (28.6)	1.688 (42.9)

* Meet requirements of M85049

Round Clamp

- Low profile
- Round cable applications

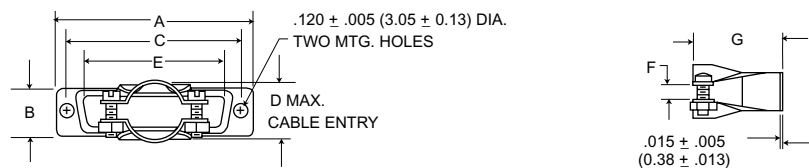

MIL-Spec.

Material: Low Carbon Steel per ASTM A-620

Finish: Yellow Chromate Over Cadmium per M85049 Specification

Non-Magnetic/No-Outgas*

Material: Brass per QQ-B-613

Finish: Gold over copper per MIL-G-45204, Type II, Grade C, Class 1 or Electroless nickel per MIL-C-26074B

(Superseded MIL-Spec. No.: M24308/21-1 thru-5)

Layout	Part Number	Mil. Spec.	Plating		A ± .015 (0.38)	B ± .015 (0.38)	C ± .005 (0.13)	D Max.	E ± .015 (0.38)	F ± .015 (0.38)	G ± .030 (0.76)
			AU	NI							
DE-9	DE44994	M85049/48-2-1	DE44994	-2 -13	1.208 (30.7)	.500 (12.7)	.984 (25.0)	.406 (10.3)	.661 (16.8)	.125 (3.2)	1.031 (26.2)
DA-15	DA20961	M85049/48-2-2	DA20961	-16 -23	1.531 (38.9)	.500 (12.7)	1.312 (33.3)	.406 (10.3)	.984 (25.0)	.125 (3.2)	1.031 (26.2)
DB-25	DB20962	M85049/48-2-3	DB20962	-18 -27	2.078 (52.8)	.500 (12.7)	1.852 (47.00)	.593 (15.1)	1.515 (38.5)	.187 (4.7)	1.062 (27.0)
DC-37	DC20963	M85049/48-2-4	DC20963	-17 -26	2.718 (69.0)	.500 (12.7)	2.500 (63.5)	.718 (18.2)	2.171 (55.1)	.250 (6.3)	1.062 (27.0)
DD-50	DD20964	M85049/48-2-5	DD20964	-19 -31	2.625 (66.7)	.609 (15.5)	2.406 (61.1)	.812 (20.6)	2.093 (53.2)	.312 (7.9)	1.062 (27.0)

* Meet requirements of M85049

Accessories - M85049 Backshells

Straight Clamp

- Low profile
- Discrete wire application

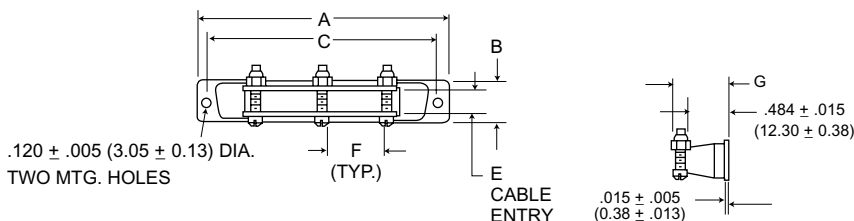

MIL-Spec.

Material: Low Carbon Steel per ASTM A-620

Finish: Yellow Chromate Over Cadmium per M85049 Specification

Non-Magnetic/No-Outgas*

Material: Brass per QQ-B-613

Finish: Gold over copper per MIL-G-45204, Type II, Grade C,
Class 1 or Electroless nickel per MIL-C-26074B

(Superseded MIL-Spec. No.: M24308/22-1 thru-4)

Layout	Part Number	Mil. Spec.	NM Non-Magnetic/ No-Outgas*		No. of Cable Locking Screws Req'd.	A ± .015 (0.38)	B ± .015 (0.38)	C ± .005 (0.13)	E ± .015 (0.38)	F ± .015 (0.38)	G ± .035 (0.89)
			Plating AU	NI							
DA-15	DA19678-1	M85049/48-3-2	DA19678	-167 -208	2	1.531 (38.9)	.500 (12.7)	1.312 (33.3)	.296 (7.5)	.312 (7.9)	.644 (16.36)
DB-25	DB19678-2	M85049/48-3-3	DB19678	-168 -209	2	2.078 (52.8)	.500 (12.7)	1.852 (47.0)	.296 (7.5)	.796 (20.2)	.644 (16.36)
DC-37	DC19678-3	M85049/48-3-4	DC19678	-138 -210	2	2.718 (69.0)	.500 (12.7)	2.500 (63.5)	.296 (7.5)	.687 (17.4)	.644 (16.36)
DD-50	DD19678-4	M85049/48-3-5	DD19678	-161 -211	3	2.625 (66.7)	.609 (15.5)	2.406 (61.1)	.390 (9.9)	.687 (17.4)	.694 (17.63)

Right Angle

- Low profile
- Spaceborne applications

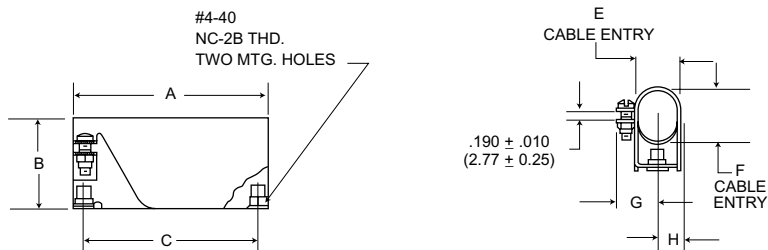

MIL-Spec.

Material: Low Carbon Steel per ASTM A-620

Finish: Yellow Chromate Over Cadmium per M85049 Specification

Non-Magnetic/No-Outgas*

Material: Brass per QQ-B-613

Finish: Gold over copper per MIL-G-45204, Type II, Grade C,
Class 1 or Electroless nickel per MIL-C-26074B

Layout	Part Number	Mil. Spec.	NM Non-Magnetic/ No-Outgas*		A ± .015 (0.38)	B ± .030 (0.76)	C ± .005 (0.13)	E ± .030 (0.76)	F ± .030 (0.76)	G ± .030 (0.76)	H ± .030 (0.76)
			Plating AU	NI							
DE-9	DE19977-5	M85049/50-1	DE19977	-47 -63	1.203 (30.6)	.718 (18.2)	.984 (25.0)	.437 (11.1)	.437 (11.1)	.468 (11.9)	.281 (7.1)
DA-15	DA19977-1	M85049/50-2	DE19977	-40 -64	1.531 (38.9)	.718 (18.2)	1.312 (33.3)	.437 (11.1)	.437 (11.1)	.468 (11.9)	.281 (7.1)
DB-25	DB19977-2	M85049/50-3	DE19977	-43 -52	2.078 (52.8)	.968 (24.6)	1.852 (47.0)	.437 (11.1)	.625 (15.9)	.468 (11.9)	.281 (7.1)
DC-37	DC19977-3	M85049/50-4	DE19977	-45 -65	2.718 (69.0)	1.187 (30.10)	2.500 (63.5)	.437 (11.1)	.812 (20.6)	.468 (11.9)	.281 (7.1)
DD-50	DD19977-4	M85049/50-5	DE19977	-44 -66	2.625 (66.7)	1.250 (31.7)	2.406 (61.1)	.562 (14.3)	.906 (23.1)	.531 (13.5)	.343 (8.7)

* Meet requirements of M85049

Accessories - Shielded Metalized Plastic Backshells

Snap-Together

- Quick and simple assembly using snap-together design feature
- No complicated crimp ferrule tooling needed
- Helps to comply with FCC shielding requirements

Material:	ABS Polymer
Finish:	Nickel over Copper
Temperature Range:	20/80°C
Attenuation:	44 DB @ 1000 MHZ

Design includes integral strain relieving cable clamp.

Backshell requires hardware - see page 372.

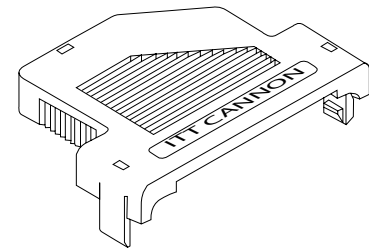
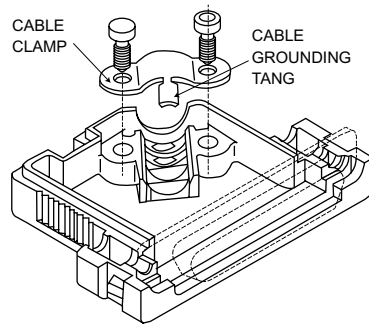

Straight Exit

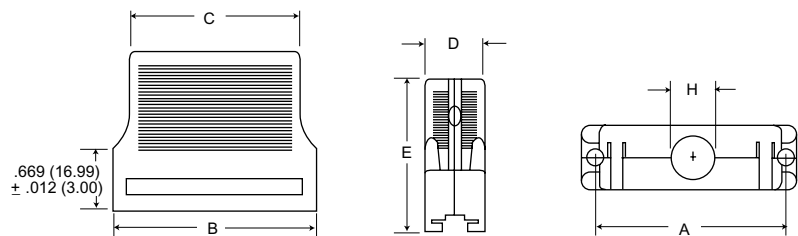

Layout	Part Number	A ± .006 (0.15)	B ± .012 (0.30)	C ± .012 (0.30)	C ± .012 (0.30)	E ± .008 (0.20)	H Max.
DE-9	DE121073-154	.982 (24.95)	1.213 (30.8)	.933 (23.7)	.630 (16.0)	1.417 (36.0)	.288 (7.32)
DA-15	DA121073-150	1.311 (33.30)	1.539 (39.1)	1.252 (31.8)	.630 (16.0)	1.654 (42.0)	.327 (8.31)
DB-25	DB121073-151	1.850 (47.00)	2.087 (53.0)	1.772 (45.0)	.630 (16.0)	1.654 (42.0)	.414 (10.52)
DC-37	DC121073-152	2.498 (63.45)	2.728 (69.3)	2.374 (60.3)	.630 (16.0)	1.654 (42.0)	.485 (12.32)

40° Exit

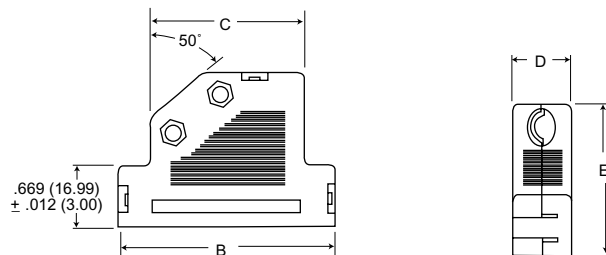

Layout	Part Number	B ± .012 (0.30)	C ± .012 (0.30)	D ± .012 (0.30)	E ± .008 (0.20)	Cable Diameter	
						Min.	Max.
DE-9	DE121073-54	1.417 (36.0)	.866 (22.0)	.630 (16.0)	1.417 (36.0)	.138 (3.5)	.295 (7.5)
DA-15	DA121073-50	1.744 (44.3)	1.075 (27.3)	.630 (16.0)	1.654 (42.0)	.256 (6.5)	.354 (9.0)
DB-25	DB121073-51	2.283 (58.0)	1.614 (41.0)	.630 (16.0)	1.654 (42.0)	.256 (6.5)	.433 (11.0)
DC-37	DC121073-52	2.933 (74.5)	2.264 (57.5)	.630 (16.0)	1.654 (42.0)	.256 (6.5)	.433 (11.0)
DD-50	DD121073-53	2.873 (73.0)	2.165 (55.0)	.748 (19.0)	1.654 (42.0)	.354 (9.0)	.512 (13.0)

Accessories - Shielded Backshells

#4-40 Locking Hardware For Snap-Together Shielded Backshells

Recessed Jackscrew

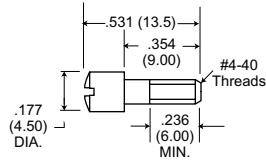
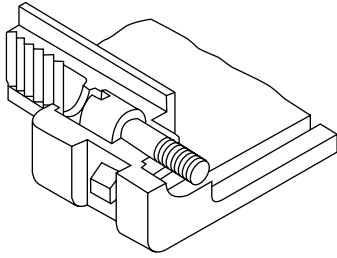

Part Number:	250-8501-004
Material:	Brass
Finish:	Nickel
Quantity Required per Backshell:	2

Extended Jackscrew

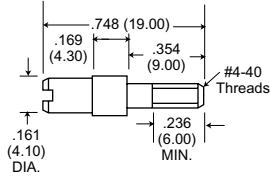
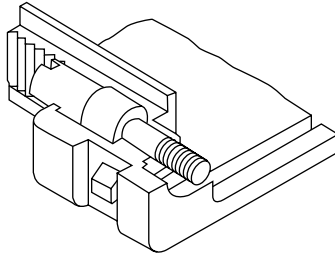

Part Number:	250-8501-010
Material:	Brass
Finish:	Nickel
Quantity Required per Backshell:	2

Thumbscrew

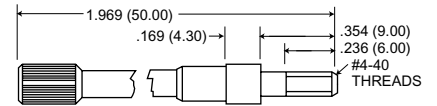
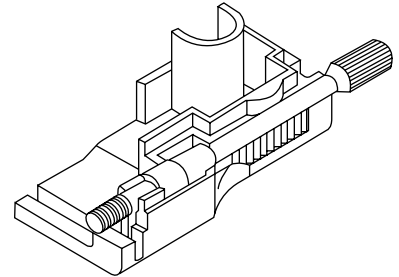

Part Number:	250-8501-013
Material:	Brass
Finish:	Nickel
Quantity Required per Backshell:	2

Accessories - Shielded Backshells

Metal Blackshell

Straight Cable Exit

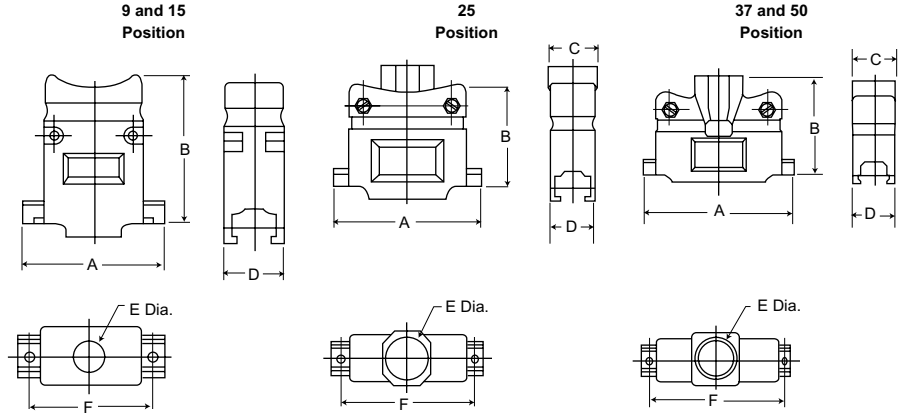

- EMI/RFI protection
- Integral grommet to protect against

MATERIAL SPECIFICATIONS

Cover:	Die Cast Zinc
Finish:	Clear Zinc Plate
Inserts:	PVC
Hardware:	Steel
Finish:	Clear Zinc

Size	Part Number	A ± .005 (0.13)	B ± .005 (0.13)	C ± .005 (0.13)	D ± .005 (0.13)	E ± .005 (0.13)	F ± .005 (0.13)
9	980-2000-345	1.225 (31.12)	1.465 (37.21)	.620 (15.75)	.620 (15.75)	.400 (10.16)	.984 (24.99)
15	980-2000-346	1.540 (39.12)	1.600 (40.64)	.620 (15.75)	.620 (15.75)	.400 (10.16)	1.312 (33.32)
25	980-2000-347	2.090 (53.09)	1.550 (39.37)	.690 (17.53)	.620 (15.75)	.525 (13.34)	1.857 (47.17)
37	980-2000-348	2.730 (69.34)	1.800 (45.72)	.864 (21.95)	.620 (15.75)	.726 (18.44)	2.500 (63.50)
50	980-2000-349	2.626 (66.70)	1.800 (45.72)	.864 (21.95)	.730 (18.54)	.726 (18.44)	2.406 (61.11)

Metalized-Plastic Backshell

Straight Cable Exit

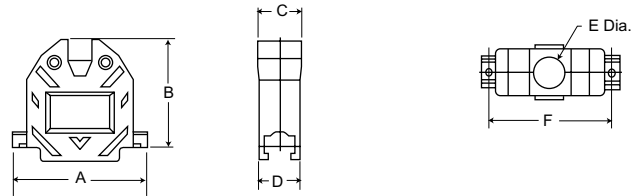

MATERIAL SPECIFICATIONS

Cover:	ABS Polymer
Finish:	Nickel over Copper
Inserts:	PVC
Hardware:	Steel
Finish:	Clear Zinc

Size	Part Number	A ± .005 (0.13)	B ± .005 (0.13)	C ± .005 (0.13)	D ± .005 (0.13)	E ± .005 (0.13)	F ± .005 (0.13)
9	980-2000-350	1.217 (30.91)	1.547 (39.29)	.640 (16.26)	.640 (16.26)	.400 (10.16)	.984 (24.99)
15	980-2000-351	1.545 (39.29)	1.505 (38.23)	.640 (16.26)	.640 (16.26)	.400 (10.16)	1.312 (33.32)
25	980-2000-352	2.090 (53.09)	1.655 (42.04)	.710 (18.03)	.640 (16.26)	.522 (13.26)	1.857 (47.17)
37	980-2000-353	2.734 (69.44)	1.830 (46.48)	.906 (23.01)	.640 (16.26)	.726 (18.44)	2.500 (63.50)
50	980-2000-354	2.645 (67.18)	1.855 (47.12)	.940 (23.88)	.770 (19.56)	.726 (18.44)	2.406 (61.11)

Highlight part numbers indicate standard product; usually available with shorter lead times.

Compression Inserts (Included With Backshell)

Accommodates a wide range of cable diameters-

- 9 position - .190/.350
- 15 position - .190/.350
- 25 position - .190/.460
- 37 position - .300/.680
- 50 position - .300/.680

9 and 15 Position

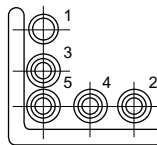

25 Position

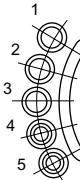

37 and 50 position

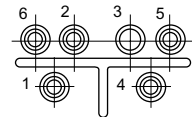

Positions	#1		#2		#3		#4		#5		#6	
	O.D.	I.D.	O.D.	I.D.	O.D.	I.D.	O.D.	I.D.	O.D.	I.D.	O.D.	I.D.
9, 15	0.475 (12.07)	0.320 (8.13)	0.360 (9.14)	0.315 (8.000)	0.360 (9.14)	0.255 (6.48)	0.360 (9.14)	0.285 (7.24)	0.360 (9.14)	0.210 (5.33)	N/A	N/A
25	0.600 (15.24)	0.450 (11.43)	0.450 (11.43)	0.410 (10.41)	0.450 (11.43)	0.370 (9.40)	0.450 (11.43)	0.300 (7.62)	0.450 (11.43)	0.230 (5.84)	N/A	N/A
37, 50	0.655 (16.64)	0.570 (14.48)	0.700 (17.78)	0.620 (15.75)	0.810 (20.57)	0.650 (16.51)	0.655 (16.64)	0.500 (12.70)	0.655 (16.64)	0.425 (10.80)	0.655 (16.64)	0.350 (8.89)

Accessories - Plastic Backshells

Universal

- Economical design uses an adjustable tie-wrap for cable strain relief for cable strain relief
- Compatible with male screw locks and spring latches
- U.L. rated 94V-2 (flame retardant)
248-2670-001 Listing

Straight

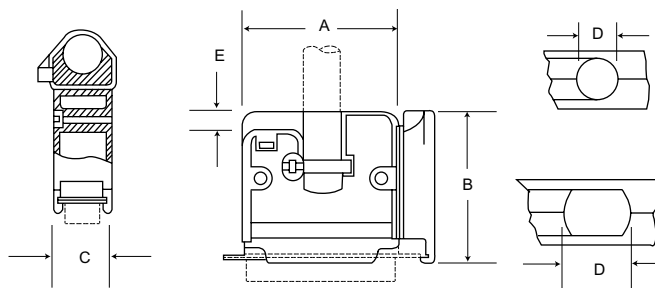

Material: Junction shell-polypropylene; Hardware-steel; Tie-wrap-nylon.
Finish: Hardware-cadmium plate, yellow chromate.
Color: Black (junction shell).

Layout	Part Number	$\pm .015$ (0.38)	$\pm .015$ (0.38)	$\pm .015$ (0.13)	$\pm .015$ (0.38)	$\pm .010$ (0.25)
DE-9	DE110963-1	.765 (19.43)	1.400 (35.56)	.600 (15.24)	.250 (6.35)	.125 (3.18)
DA-15	DA110963-2	1.097 (27.86)	1.569 (39.85)	.600 (15.24)	.375 (9.53)	.161 (4.09)
DB-25	DB110963-3	1.641 (41.68)	1.651 (41.94)	.600 (15.24)	.410 (10.41)	.205 (5.21)
DC-37	DC110963-4	2.279 (57.89)	1.899 (48.23)	.600 (15.24)	.593 (15.06)	.205 (5.21)
DD-50	DD110963-5	2.063 (52.40)	1.925 (48.90)	.710 (18.03)	.670 (17.01)	.285 (7.24)

Snap-Together Universal

- A 2-piece snap-together design for quick assembly
- Customer furnishes tie-wrap

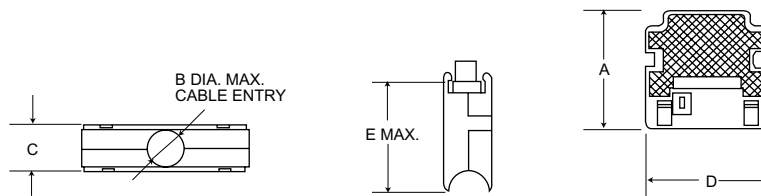

Material: Flame-retardant thermoplastic, UL 94V-0 rated.

Layout	Part Number	$\pm .008$ (0.20)	B Max.	$\pm .008$ (0.20)	$\pm .008$ (0.20)	E Max.
DE-9	DE115339-20	1.673 (42.5)	.276 (7.0)	.669 (17.0)	.768 (19.5)	1.555 (39.5)
DA-15	DA115339-21	1.673 (42.5)	.378 (9.6)	.669 (17.0)	1.094 (27.8)	1.555 (39.5)
DB-25	DB115339-22	1.673 (42.5)	.457 (11.6)	.669 (17.0)	1.638 (41.6)	1.555 (39.5)
DC-37	DC115339-23	1.673 (42.5)	.512 (13.0)	.669 (17.0)	2.283 (58.0)	1.555 (39.5)
DD-50	DD115339-24	1.673 (42.5)	.630 (16.0)	.780 (19.8)	2.060 (52.3)	1.555 (39.5)

One-Piece Snap Together

- Low cost
- Easy to assemble
- Aesthetically pleasing
- Includes: thumbscrews, cable clamps

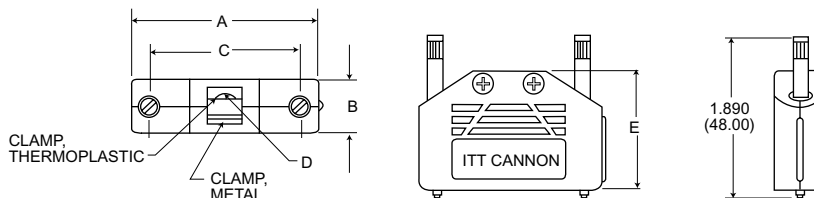

Material: Specification: Plastic - polypropylene; Hardware - steel.
Finish: Yellow chromate over zinc.

Layout	Part Number	A	B	C	D Dia. Max.	E
DE-9	DEBS-9	1.386 (35.20)	.638 (16.21)	.984 (24.99)	.224 (5.69)	1.083 (27.51)
DA-15	DABS-15	1.705 (43.31)	.638 (16.21)	1.312 (33.32)	.224 (5.69)	1.228 (31.19)
DB-25	DBBS-25	2.252 (57.20)	.638 (16.21)	1.852 (47.04)	.256 (6.50)	1.508 (38.30)

Accessories - Plastic Backshells

One Piece Plastic

- Straight or 90° cable exit
- Integral cable clamp and set screw
- Accommodates spring latches
- UL 94V-2 rated flame retardant
- Mounting hardware included

Straight Cable Exit

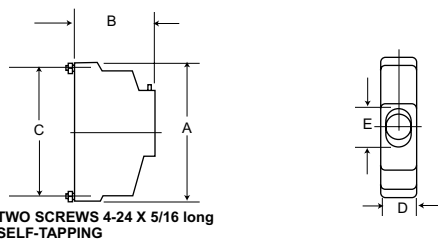

Material: Thermoplastic UL 94V-2 rated
Color: Black
Screws: Steel, cadmium plated

Layout	Part Number	A ± .015 (0.38)	B ± .015 (0.38)	C ± .015 (0.13)	C ± .015 (0.38)	E ± .010 (0.25)
DE-9	DE51218	1.218 (30.9)	1.000 (25.4)	.984 (25.0)	.500 (12.7)	.281 (7.1)
DA-15	DA51210	1.546 (39.3)	1.000 (25.4)	1.312 (33.3)	.500 (12.7)	.360 (9.1)
DB-25	DB51212	2.093 (53.2)	1.250 (31.7)	1.852 (47.0)	.500 (12.7)	.493 (12.5)
DC-37	DC51214	2.734 (69.4)	1.500 (38.1)	2.500 (63.5)	.500 (12.7)	.967 (17.6)
DD-50	DD51216	2.640 (67.1)	1.500 (38.1)	2.406 (61.1)	.609 (15.5)	.734 (18.6)

- 90° Cable Exit
- Integral cable clamps & set screw
- UL 94V-2 rated flame retardant
- Mounting Hardware included

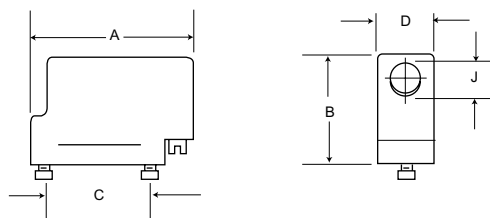

Material: Thermoplastic UL 94V-2 rated
Color: Black
Screws: Steel, cadmium plated

Layout	Part Number	A ± .015 (0.38)	B ± .015 (0.38)	C ± .015 (0.13)	C ± .015 (0.38)	E ± .010 (0.25)
DA-15	DA51211	1.822 (46.3)	1.000 (25.4)	1.312 (33.3)	.500 (12.7)	.360 (9.1)
DB-25	DB51213	2.386 (60.1)	1.250 (31.7)	1.852 (47.0)	.500 (12.7)	.493 (12.5)
DC-37	DC51215	3.009 (76.4)	1.500 (38.1)	2.500 (63.5)	.500 (12.7)	.694 (17.6)
DD-50	DD51217	2.915 (74.0)	1.500 (38.1)	2.406 (61.1)	.609 (15.5)	.734 (18.6)

Dataphone

- Available in 25 position only
- Supplied with screws

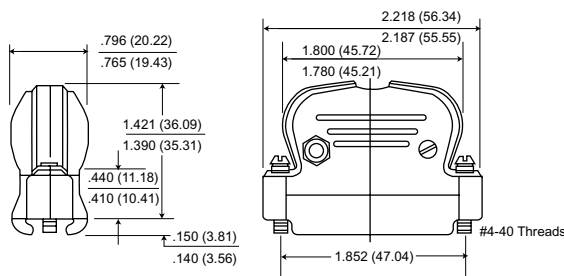

Max. Cable Entry .312 (7.92)

Material: Junction shell - Thermoplastic UL 94V-0 rated. Hardware - steel.
Finish: Hardware - cadmium plate, clear chromate.
Color: Black
Part Number: DB51226-1B

Accessories - Plastic Backshells

Quick-Disconnect Backshells for IDC Cable

IDC

Order locking hardware separately.

- Optional Spring Clips provide quick disconnect for either flat IDC cable or round jacketed cable
- Designed for use with keying plates sold separately

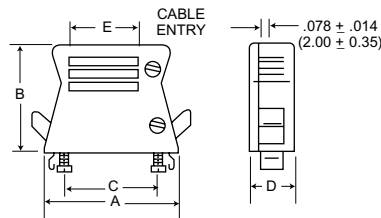

Material: Thermoplastic, UL 94V-0 rated
Color: Black

Layout	Part Number	A Max.	B Max.	C ± .005 (.013)	D Max.	E ± .008 (0.2)
DE-9	DE115386-1B	1.623 (41.2)	1.596 (40.5)	.984 (25.0)	.642 (16.3)	.590 (15.0)
DA-15	DA115386-2B	1.950 (49.5)	1.596 (40.5)	1.311 (33.3)	.642 (16.3)	.917 (23.3)
DB-25	DB115386-3B	2.490 (63.2)	1.596 (40.5)	1.852 (47.0)	.642 (16.3)	1.456 (37.0)
DC-37	DC115386-4B	3.140 (79.7)	1.596 (40.5)	2.500 (63.5)	.642 (16.3)	2.106 (53.5)

Quick-Disconnect Backshells for Round Cable

Round Cable - Straight and 90° Exit

Order locking hardware separately.

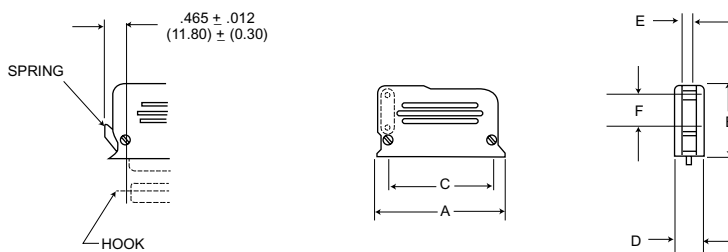

Material: Thermoplastic, UL 94V-0 rated
Color: Black

Layout	Part Number	A Max.	B Max.	C ± .005 (.013)	D Max.	E ± .008 (0.2)	F Min.
DE-9	DE115339	1.623 (41.2)	1.596 (40.5)	.984 (25.0)	.642 (16.3)	.590 (15.0)	.264 (6.7)
DA-15	DA115339-1	1.950 (49.5)	1.596 (40.5)	1.311 (33.3)	.642 (16.3)	.917 (23.3)	.264 (6.7)
DB-25	DB115339-2	2.490 (63.2)	1.596 (40.5)	1.852 (47.0)	.642 (16.3)	1.456 (37.0)	.697 (17.7)
DC-37	DC115339-3	3.140 (79.7)	1.596 (40.5)	2.500 (63.5)	.642 (16.3)	2.106 (53.5)	.697 (17.7)
DD-50	DD115339-4	3.023 (76.8)	1.653 (42.0)	2.405 (61.1)	.748 (19.0)	.433 (11.0)	.697 (17.7)

Optional Locking Mechanism/Hardware

Material: Corrosion-resistant steel.

NOTE: When used with keying plate, order lock hook part number 015-8755-001.



Lock Hook
Part No. 015-8755-000
Order 2 per connector
Note: Not for use on rear panel mounted connectors.

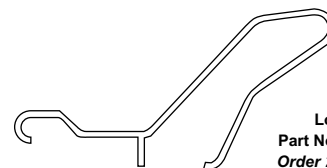

Lock Spring
Part No. 259-8760-000
Order 2 per connector

Accessories - Locking Hardware

Screw Locks

- ¥ Insures positive mating.
- ¥ Used for vibration applications.

Front Panel Mount

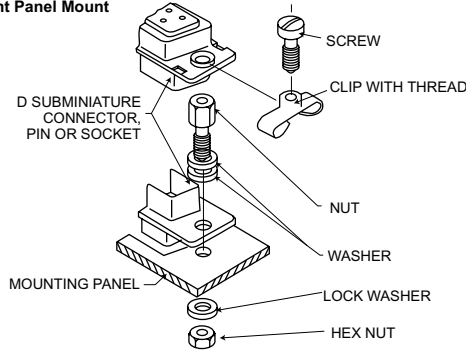

Rear Panel Mount

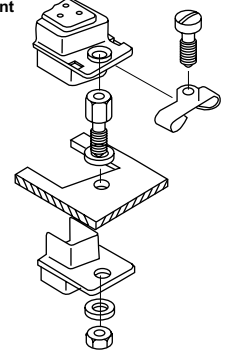

Female Srew Locks

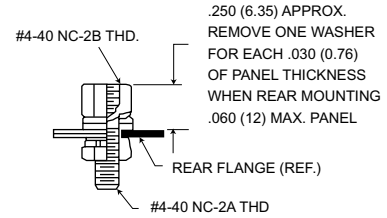
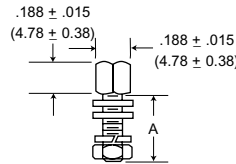

Order 2 per connector.

Cadmium With Yellow Chromate	M24308 MIL-Spec.	A ± .015 (0.38)
D20418-2	M24308/26-1	.312 (7.92)
D20418-50		.500 (12.70)
D20418-39	M24308/26-2	.625 (15.88)
D20418-74		.750 (19.05)

Material: Cold rolled steel.

Finish: Cadmium plate, yellow chromate

NOTE: (1) A 6 inch/pound (female) and 4 inch/pound (male) maximum torque during assembly is recommended on steel screw lock assemblies.

(2) A third flat washer is supplied for front panel mounting of tab shell connectors.

NM For Use With Non-Magnetic/No-Dutgas Products

NM Brass	NM Stainless Steel	A ± .015 (0.38)
D20418-52	D20418-14	.312 (7.92)
N/A	D20418-102	.500 (12.70)
D20418-101	D20418-77	.625 (15.88)

NM - Non-Magnetic Finish and Material:

Passivated (Stainless Steel). Gold over copper per MIL-G-45204, Type II, Class 2 (Brass)

Male Srew Locks

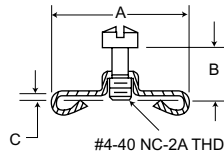

Standard Material: Clip-sheet steel; hardware-cold rolled steel.

Standard Finis: Cadmium plate, yellow chromate.

Commercial: 100 microinch zinc minimum.

Passivated (Stainless Steel). Gold over copper per MIL-G45204, Type II, Class 2 (Brass).

Order 2 per connector.

Cadmium With Yellow Chromate	NM Brass	NM Stainless Steel	A ± .015 (0.38)	B ± .010 (0.25)	C ± .005 (0.13)	Connector Size
D20419	D20419-74	N/A	.555 (14.10)	.250 (6.35)	.048 (1.22)	DE9, DA15, DB25, DC37
D20419-18	D20419-103	D20419-38	.555 (14.10)	.281 (7.14)	.067 (1.70)	DE9, DA15, DB25, DC37
D20419-21	N/A	D20419-80	.555 (14.10)	.281 (7.14)	.092 (2.34)	DE9, DA15, DB25, DC37
D20419-104	N/A	N/A	.555 (14.10)	.312 (7.92)	.092 (2.34)	DE9, DA15, DB25, DC37
D20420	D20419-67	N/A	.656 (16.66)	.250 (6.35)	.048 (1.22)	DD50
D20420-13	D20419-74	D20419-108	.656 (16.66)	.281 (7.14)	.067 (1.70)	DD50
D20420-15	N/A	D20419-70	.656 (16.66)	.281 (7.14)	.092 (2.34)	DD50
D20420-86	N/A	N/A	.656 (16.66)	.312 (7.92)	.092 (2.34)	DD50

NM - Non-Magnetic Finish & Material: Passivated (Stainless Steel). Gold over copper per MIL-G-4520, Type II, Class 2 (Brass).

NOTE: (1) A 6 inch/pound (female) and 4 inch/pound (male) maximum torque during assembly is recommended on steel screw lock assemblies.

(2) A third flat washer is supplied for front panel mounting of tab shell connectors.

Highlighted part numbers indicate standard product; usually available with shorter lead times.



Dimensions are shown in inches (millimeters).
Dimensions subject to change.

www.ittcannon.com

Accessories - Locking Hardware

Slide Latch Assemblies

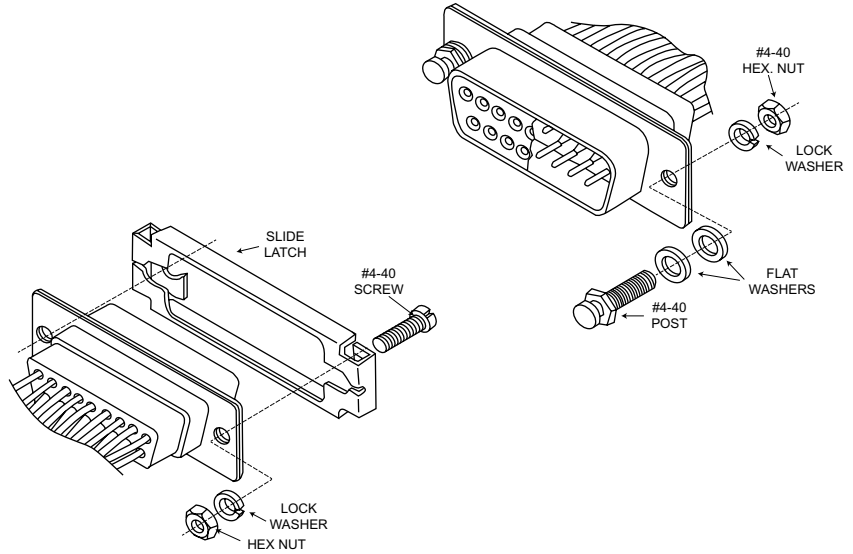

Slide Lock Post Kit



Kit consists of 1 post, 2 spacer washers, 1 lock washer and hex nut.

Order 2 per connector.

Material	Cadmium With Yellow Chromate
Steel	D53018
Brass	D53018-5

NOTE: When rear-mounting connector to a 1/16" panel, delete the 2 spacer washer.

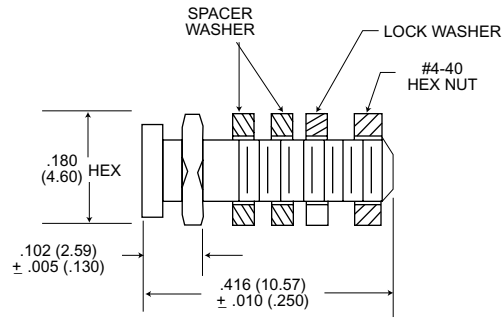

Slide Latch Kit

- Ideal for Ethernet Applications



Kit consists of slide latch retainer, 2 screws, 2 nuts, 2 lock washer.

Order one per connector.

Description	Material	Finish
Retainer Sliding lock	Stainless Steel per QQ-S-766	Passivated per QQ-P-35
Screw, Mtg,		Yellow chromate over 100 micro-inch cadmium per QQ-P-416.
Washer, Lock	Steel	
Nut, Hex		

Highlighted part numbers indicated standard product; usually available with shorter lead times.

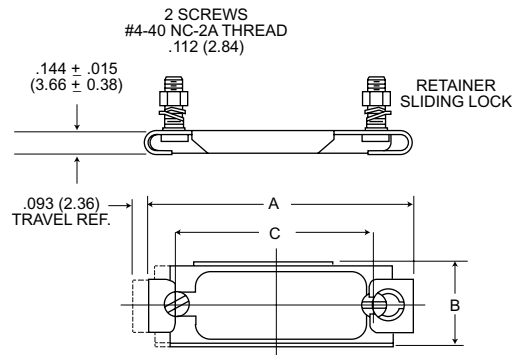

Layout	Cadmium With Yellow Chromate	A ± .015 (0.38)	B ± .015 (0.38)	C ± .005 (0.13)
DE-9	DE51224-1	1.380 (35.05)	.500 (12.70)	.984 (25.00)
DA-15	DA51220-1	1.720 (43.69)	.500 (12.70)	1.312 (33.32)
DB-25	DB51221-1	2.260 (57.40)	.500 (12.70)	1.852 (47.04)
DC-37	DC51222-1	2.908 (73.86)	.500 (12.70)	2.500 (63.50)
DD-50	DD51223-1	2.814 (71.47)	.609 (15.47)	2.406 (61.11)

Accessories - Locking Hardware

Spring Latch Assemblies

- Low cost
- Minimizes field connection time
- Positive lock between connectors

Locked

Unlocked

Spring Latch Plate

Kit consists of 1 plate, 1 screw, 1 lock washer, 1 nut.

Order two per connector.

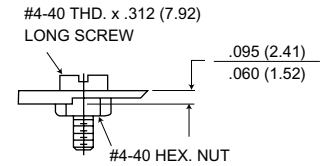
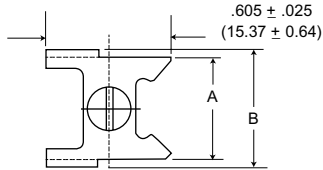
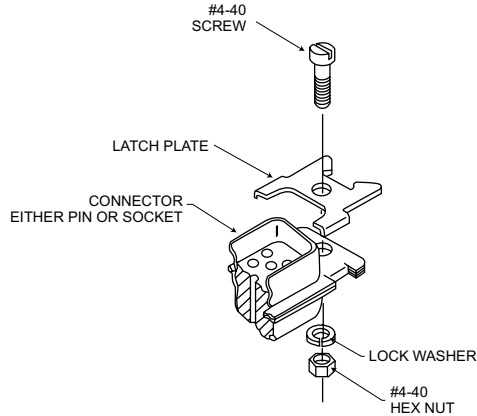

Material: Stainless Steel
Finish: Passivated

Layout	Part Number	A ± .015 (0.38)	B ± .015 (0.38)
DE-9 thru DC-37	D110278	.484 (12.29)	.556 (14.12)
DD-50 Only	D110280	.609 (15.49)	.673 (17.09)

Spring Latch

Kit consists of 1 spring, 1 screw, 1 bracket, 1 lock washer, and 1 hex nut.

Order two per connector.

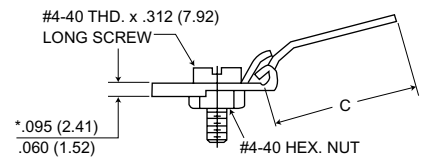
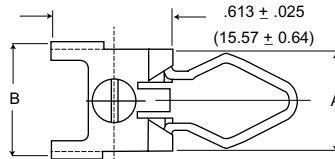
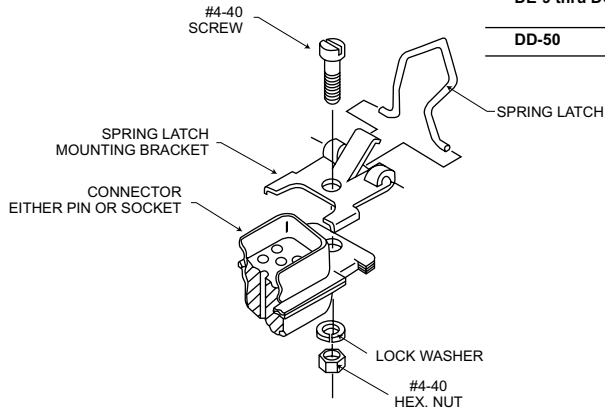

* Does not apply to rear panel mounting.

Material: Stainless Steel
Finish: Passivated

Layout	Mounting	Part Number	A ± .015 (0.38)	B ± .015 (0.38)	C ± .020 (0.51)
DE-9 thru DC-37	Front Panel	DD10277	.489 (12.42)	.565 (14.35)	.732 (18.59)
	Rear Panel	D110277-4	.489 (12.42)	.605 (15.37)	.615 (15.62)
DD-50	Front Panel	D110279	.609 (15.49)	.673 (17.09)	.732 (18.59)

Highlighted part numbers indicate standard product; usually available with shorter lead times.

Accessories - Locking Hardware

Jackscrew/Jackpost Assemblies

Jackpost - P/N D110551

Kit consists of 2 posts, 2 nuts, 2 lockwashers.

Order one per connector.

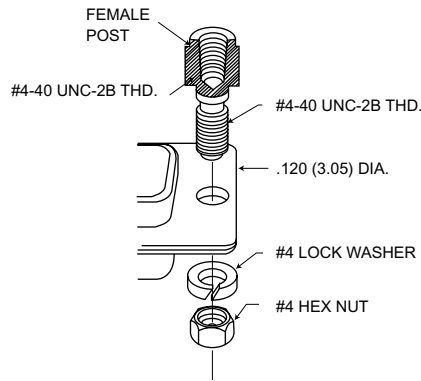

JACKPOSTS ASSEMBLY

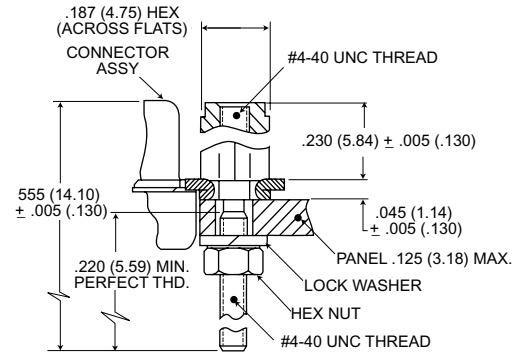

Material: Stainless Steel per QQ-S-763
Finish: Passivated per QQ-P-35

Note: Jackpost is not compatible with rear-panel mounted connectors.

Jackscrew - P/N D110550

Kit consists of 2 studs, 2 heads, and 1 tube retaining compound.

Order one per connector.

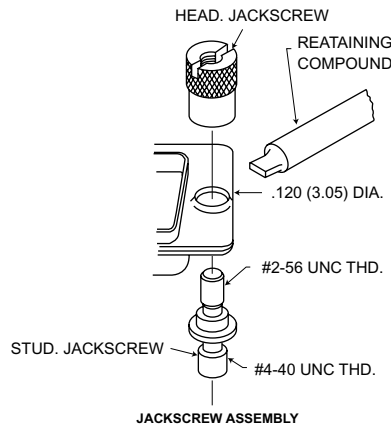

JACKSCREW ASSEMBLY

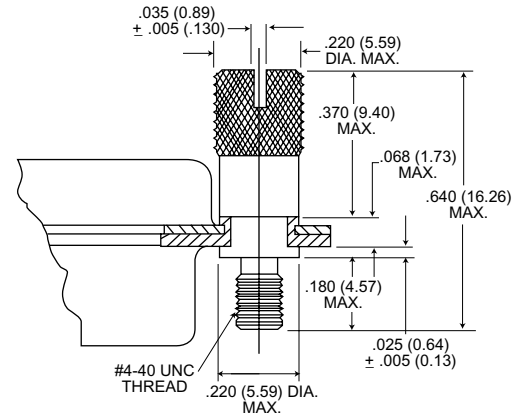

Material: Stainless Steel per QQ-S-763
Retaining Compound: per MIL-S-46163
Finish: None

Jackscrew/Jackpost Assemblies

Nylon potting shells are molded with a thin flange .030 (0.76) to permit the use of D subminiature locking devices.
Holds epoxy in place during curing.

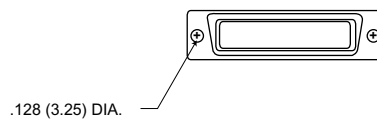

Material: Nylon
Color: Natural (white)

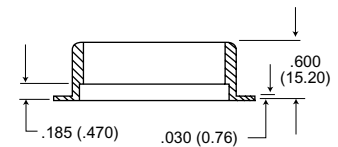

Layout	Part Number
DE-9	DE50904-1
DA-15	DA50905-1
DB-25	DB50906-1
DC-37	DC50907-1
DD-50	DD50908-1

Highlighted part numbers indicated standard product; usually available with shorter lead times.

Guide Pin Plates

Female

Blind Mate Applications



Materials

Plate: Cold rolled steel per ASTM A-620, yellow chromate over cadmium plate per QQ-P-416 Type II, Class 2

Screw: Steel, yellow chromate over 100 microinches cadmium minimum per QQ-P-416.

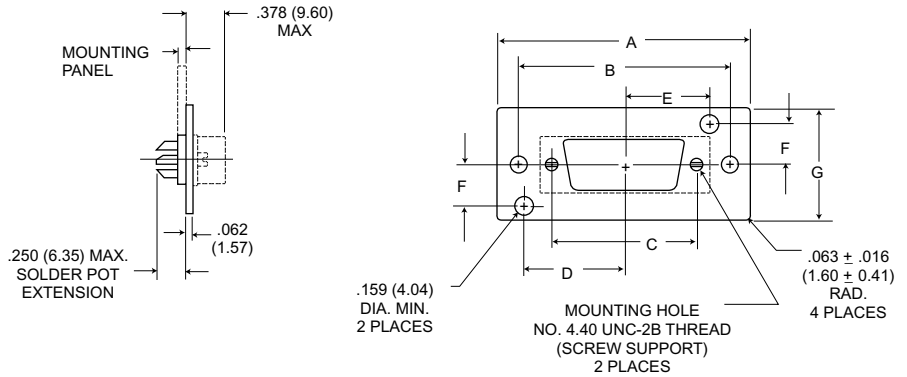

Recommended Panel Cutout

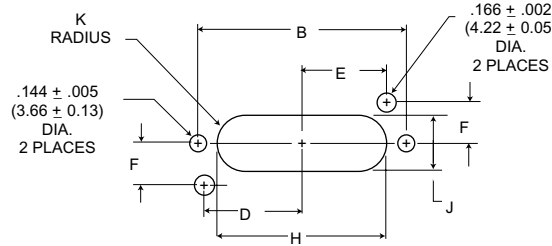

Layout	Part Number	A ± .016 (0.41)	B ± .005 (0.13)	C ± .005 (0.13)	D ± .005 (0.13)	E ± .005 (0.13)	F ± .005 (0.13)	G ± .016 (0.41)	H ± .016 (0.41)	J ± .016 (0.41)	K ± .016 (0.41)
DA-15	DA22214	2.282 (57.96)	1.906 (48.41)	1.312 (33.32)	.898 (22.81)	.765 (19.43)	.375 (9.52)	1.000 (25.40)	1.532 (38.91)	.484 (12.29)	.242 (6.15)
DB-25	DB22254	2.820 (71.63)	2.446 (62.13)	1.852 (47.04)	1.168 (29.67)	1.035 (26.29)	.375 (9.52)	1.000 (25.40)	2.016 (51.21)	.469 (11.91)	.234 (5.94)
DC-37	DC22071	3.469 (88.11)	3.094 (78.59)	2.500 (63.50)	1.492 (37.90)	1.359 (34.52)	.375 (9.52)	1.000 (25.40)	2.657 (67.49)	.469 (11.91)	.234 (5.94)
DD-50	DD21961	3.375 (85.72)	3.000 (76.20)	2.406 (61.11)	1.437 (36.50)	1.312 (33.32)	.437 (11.10)	1.125 (28.58)	2.563 (65.10)	.563 (14.30)	.282 (7.16)

Consult factory for DC size.

Male

Blind Mate Applications



Materials

Guide Pin: 303 stainless steel per MIL-S-7720 Cond. A, passivated per QQ-P-35

Screws, Rivets, Washers: Steel, Yellow chromate over 100 microinches cadmium minimum per QQ-P-416

Plate: Cold rolled steel per ASTM A-620, yellow chromate over cadmium plate per QQ-P-416, Type II, Class 2

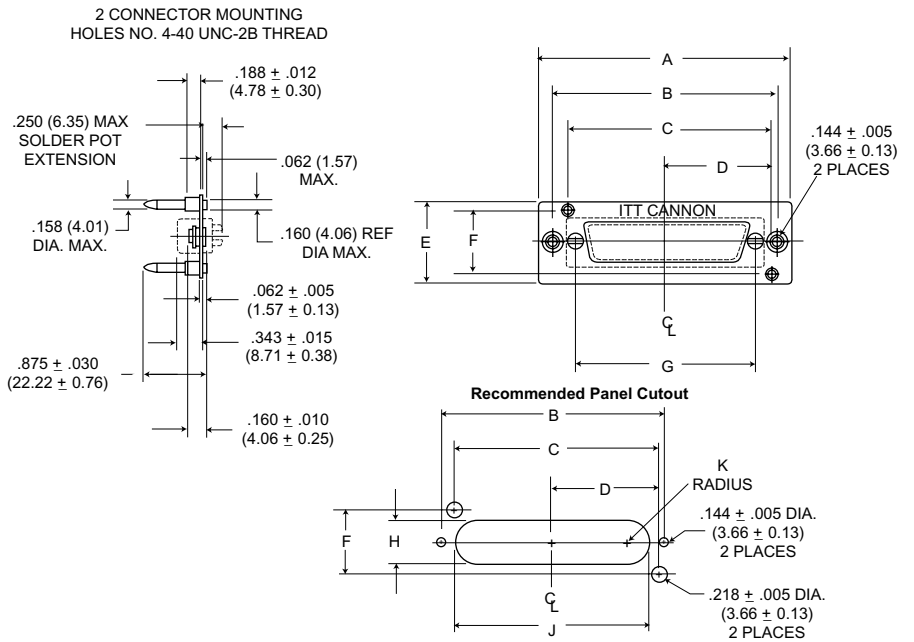

Layout	Part Number	A ± .015 (0.38)	B ± .005 (0.13)	C ± .010 (0.23)	D ± .005 (0.13)	E ± .015 (0.38)	F ± .010 (0.23)	G ± .005 (0.13)	H ± .010 (0.25)	J ± .015 (0.38)	K ± .005 (0.13)
DA-15	DA22213	2.281 (57.94)	1.906 (48.41)	1.663 (42.24)	.898 (22.81)	1.000 (25.40)	.750 (19.05)	1.312 (33.32)	.484 (12.29)	1.531 (38.89)	.242 (6.15)
DB-25	DB22255	2.820 (71.63)	2.446 (62.13)	2.203 (55.96)	1.168 (29.67)	1.000 (25.40)	.750 (19.05)	1.852 (47.04)	.484 (12.29)	2.047 (51.99)	.242 (6.15)
DC-37	DC22070	3.468 (88.09)	3.094 (78.42)	2.851 (72.42)	1.492 (37.90)	1.000 (25.40)	.750 (19.05)	2.500 (63.50)	.484 (12.29)	2.687 (68.25)	.242 (6.15)
DD-50	DD21962	3.375 (85.72)	2.300 (58.42)	2.749 (69.82)	1.437 (36.50)	1.125 (28.58)	.874 (22.20)	2.406 (61.11)	.593 (15.06)	2.635 (66.93)	.296 (7.52)

Consult factory for DC size.

Accessories

Combo D Guide Pin and Socket

Installs into any Combo D, size 8 Cavity. This patented guide pin and socket system is ideal for blind mate applications where space is limited.



Description	Material	Finish
Guide Pin	Brass	Gold over nickel
Guide Socket	Copper Alloy	Gold over nickel

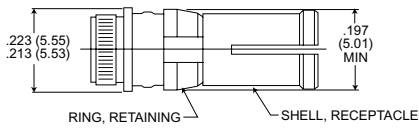

Press Fit Guide Socket
P/N DM53744-72

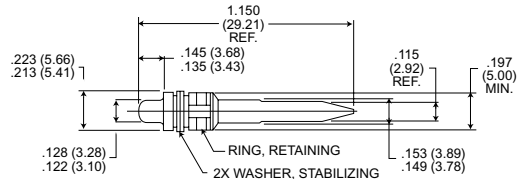
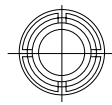

PCB Guide Pin
P/N DM53745-82

Dust Caps

Anti-static conductive dust caps (black polypropylene) protect connectors and contacts from dust and moisture.

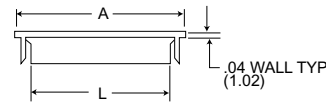
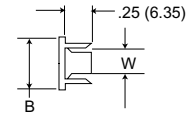
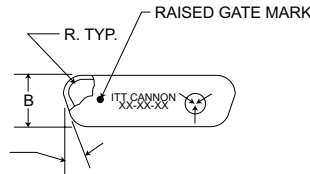

NOTE: L dim. applies at point of maximum internal interface length.

Part Numbers	I.D.	A	B	L	W
DE-59-20	Pin	.80 (20.32)	.45 (11.43)	.644 (16.36)	.299 (7.59)
DA-59-20	Pin	1.12 (28.45)	.46 (11.68)	.968 (24.59)	.300 (7.62)
DB-59-20	Pin	1.67 (42.42)	.46 (11.68)	1.506 (38.25)	.295 (7.49)
DC-59-20	Pin	2.32 (58.93)	.46 (11.68)	2.158 (54.81)	.290 (7.37)
DD-59-20	Pin	2.24 (56.90)	.57 (14.48)	2.091 (53.11)	.410 (10.41)
DE-60-20	Socket	.86 (21.84)	.51 (12.95)	.700 (17.78)	.351 (8.92)
DA-60-20	Socket	1.20 (30.48)	.51 (12.95)	1.044 (26.52)	.355 (9.02)
DB-60-20	Socket	1.74 (44.20)	.53 (13.46)	1.559 (39.60)	.358 (9.09)
DC-60-20	Socket	2.39 (60.71)	.53 (13.46)	2.240 (56.90)	.369 (9.37)
DD-60-20	Socket	2.29 (58.17)	.63 (16.00)	2.137 (54.28)	.474 (12.04)

Interfacial Seal

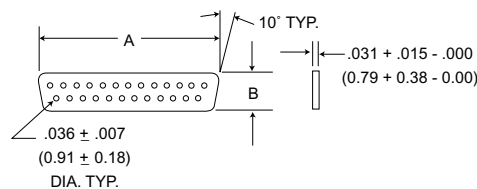

Layout	Part Number	A	B
DE-9	DE53750	.656 (16.7)	.331 (8.4)
DA-15	DA53750-1	.984 (25.0)	.331 (8.4)
DB-25	DB53750-2	1.531 (38.9)	.331 (8.4)
DC-37	DC53750-3	2.171 (55.1)	.331 (8.4)
DD-50	DD53750-4	2.078 (52.8)	.437 (11.1)

Material: Silastic sheet

Provides moisture resistance at the mating interface.



Cannon

Dimensions are shown in inches (millimeters).
Dimensions subject to change.

www.ittcannon.com

Accessories - Gender Changers & Connector Savers

Performance and Material Specifications

MATERIALS AND FINISHES

		Material	Finish
Contacts		Copper Alloy	Gold Over Nickel
Rivets		Copper Alloy	Tin/Lead
Shells		Steel	Tin/Lead
Insulator (Gender Changer):	M/M	Glass Epoxy	-
	F/F	Thermo Plastic	-
Spacer		Zinc Alloy	-
Locking Nut		Steel	Clear Chromate Over Cadmium
Washers		Steel	Clear Chromate Over Cadmium
Washer, Captive		Mylar	None

MECHANICAL FEATURES

Coupling - Friction and lock accessories
Polarization - Keystone-shaped shells

PERFORMANCE SPECIFICATIONS

Temperature Rating: -55° to +105° C
Current Rating: 3 Amp continuous
Dielectric Withstanding Voltage: 500 VAC at Sea Level

Dimensions/Part Numbers

Gender Changer Male/Male

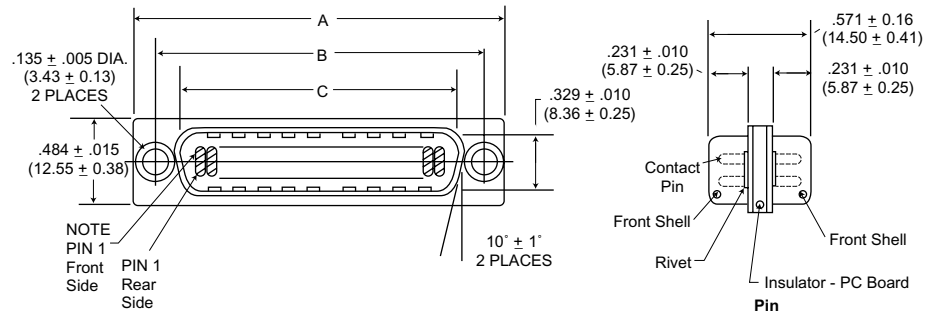

Gender Changer Female/Female

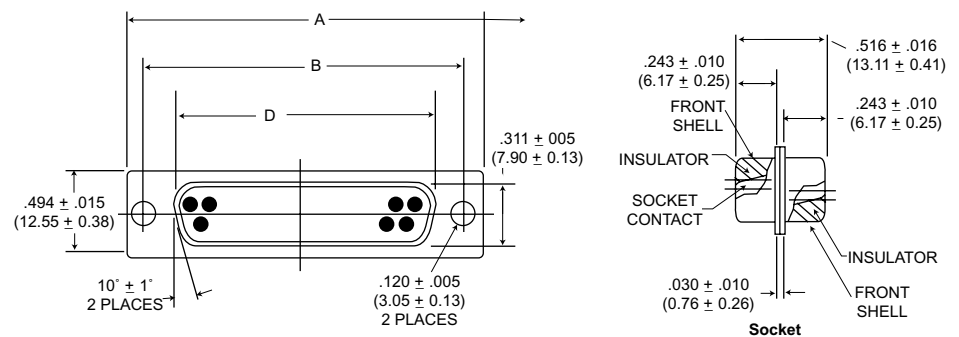

Connector Saver

Engaging View, Pin Side

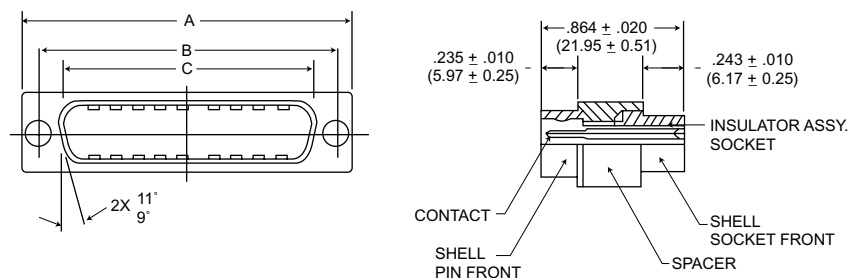

Number of Contacts (Shell Size)	Gender Changer Part Numbers				Connectors Saver Part Numbers	A ± .015 (0.4)	B ± .010 (0.25)	C ± .010 (0.25)	D ± .005 (0.13)
	Male/Male		Female/Female						
	Without Hardware	With Hardware Assembled	Without Hardware	With Hardware Assembled					
9 (E)	DE111805-1	DE11805-5	DE111813	DE111813-3	DEBU111515	1.213 (30.81)	.984 (24.99)	.666 (16.92)	.643 (16.33)
15 (A)	DE111806-1	DA11806-5	DA111810	DA111810-3	DABU111512	1.541 (39.14)	1.312 (33.32)	.994 (25.25)	.971 (24.66)
25 (B)	DE111807-1	DB11807-5	DB111811	DB111811-2	DBBU111511	2.088 (53.04)	1.852 (47.04)	1.534 (38.96)	1.511 (38.38)
37 (C)	DE111808-1	DC11808-5	Not Available	Not Available	Not Available	2.729 (69.32)	2.500 (63.50)	2.182 (55.42)	††

D Subminiature

Panel Cutouts

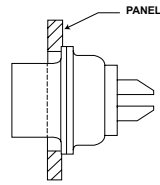

Rear mounting of standard shell

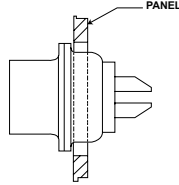

Front mounting of standard shell

Standard Cutout

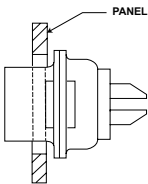
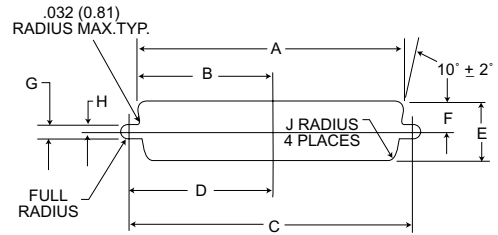

Rear mounting of float mount shell (Y-Code)

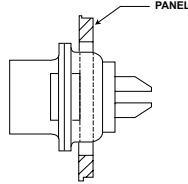

Front mounting of reverse mount shell (Y-Code)

Optional Cutout (For Rear Mounting)

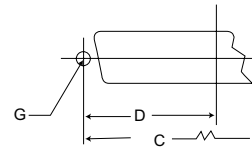

Connector Size	Mounting Method	A ± .005 (0.13)	B ± .005 (0.13)	C ± .005 (0.13)	D ± .005 (0.13)	E ± .005 (0.13)	F ± .005 (0.13)	G ± .002 (0.05)	H ± .002 (0.05)	J ± .002 (0.05)
A Standard	Front Mounting	1.202 (30.53)	.601 (15.26)	1.312 (33.32)	.656 (16.66)	.513 (13.03)	.257 (6.52)	.120 (3.04)	.060 (1.52)	.083 (2.10)
	Rear Mounting	1.134 (28.80)	.567 (14.40)	1.312 (33.32)	.656 (16.66)	.449 (11.40)	.225 (5.71)	.120 (3.04)	.060 (1.52)	.132 (3.35)
A Float	Front Mounting	1.234 (31.34)	.617 (15.67)	1.312 (33.32)	.656 (16.66)	.545 (13.84)	.273 (6.93)	.088 (2.23)	.044 (1.11)	.083 (2.10)
	Rear Mounting	1.166 (29.61)	.583 (14.80)	1.312 (33.32)	.656 (16.66)	.481 (12.21)	.241 (6.12)	.088 (2.23)	.044 (1.11)	.132 (3.35)
B Standard	Front Mounting	1.743 (44.27)	.872 (22.14)	1.852 (47.04)	.926 (23.52)	.513 (13.03)	.257 (6.52)	.120 (3.04)	.060 (1.52)	.083 (2.10)
	Rear Mounting	1.674 (42.51)	.837 (21.25)	1.852 (47.04)	.926 (23.52)	.449 (11.40)	.225 (5.71)	.120 (3.04)	.060 (1.52)	.132 (3.35)
B Float	Front Mounting	1.775 (45.08)	.888 (22.55)	1.852 (47.04)	.926 (23.52)	.545 (13.84)	.273 (6.93)	.088 (2.23)	.044 (1.11)	.083 (2.10)
	Rear Mounting	1.706 (43.33)	.853 (21.66)	1.852 (47.04)	.926 (23.52)	.481 (12.21)	.241 (6.12)	.088 (2.23)	.044 (1.11)	.132 (3.35)
C Standard	Front Mounting	2.391 (60.73)	1.196 (30.37)	2.500 (63.50)	1.250 (31.75)	.513 (13.03)	.257 (6.52)	.120 (3.04)	.060 (1.52)	.083 (2.10)
	Rear Mounting	2.326 (59.08)	1.163 (29.54)	2.500 (63.50)	1.250 (31.75)	.449 (11.40)	.225 (5.71)	.120 (3.04)	.060 (1.52)	.132 (3.35)
C Float	Front Mounting	2.423 (61.54)	1.212 (30.78)	2.500 (63.50)	1.250 (31.75)	.545 (13.84)	.273 (6.93)	.088 (2.23)	.044 (1.11)	.083 (2.10)
	Rear Mounting	2.354 (59.79)	1.177 (29.89)	2.500 (63.50)	1.250 (31.75)	.481 (12.21)	.241 (6.12)	.088 (2.23)	.044 (1.11)	.132 (3.35)
D Standard	Front Mounting	2.297 (58.34)	1.149 (29.18)	2.406 (61.11)	1.203 (30.55)	.623 (15.82)	.312 (7.92)	.120 (3.04)	.060 (1.52)	.083 (2.10)
	Rear Mounting	2.218 (56.33)	1.109 (28.16)	2.406 (61.11)	1.203 (30.55)	.555 (14.09)	.278 (7.06)	.120 (3.04)	.060 (1.52)	.132 (3.35)
D Float	Front Mounting	2.329 (59.15)	1.165 (29.59)	2.406 (61.11)	1.203 (30.55)	.655 (16.63)	.328 (8.33)	.088 (2.23)	.044 (1.11)	.083 (2.10)
	Rear Mounting	2.250 (57.15)	1.125 (28.57)	2.406 (61.11)	1.203 (30.55)	.587 (14.90)	.294 (7.46)	.088 (2.23)	.044 (1.11)	.132 (3.35)
E Standard	Front Mounting	.874 (22.19)	.437 (11.09)	.984 (24.99)	.492 (12.49)	.513 (13.03)	.257 (6.52)	.120 (3.04)	.060 (1.52)	.083 (2.10)
	Rear Mounting	.806 (20.47)	.403 (10.23)	.984 (24.99)	.492 (12.49)	.449 (11.40)	.225 (5.71)	.120 (3.04)	.060 (1.52)	.132 (3.35)
E Float	Front Mounting	.906 (23.01)	.453 (11.50)	.984 (24.99)	.492 (12.49)	.545 (13.84)	.273 (6.93)	.088 (2.23)	.044 (1.11)	.083 (2.10)
	Rear Mounting	.838 (21.28)	.419 (10.64)	.984 (24.99)	.492 (12.49)	.481 (12.21)	.241 (6.12)	.088 (2.23)	.044 (1.11)	.132 (3.35)

Panel Mounting

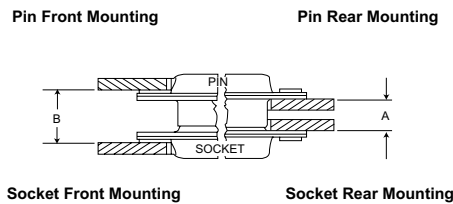

Figure 1A

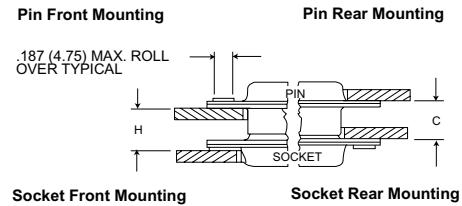

Figure 1B

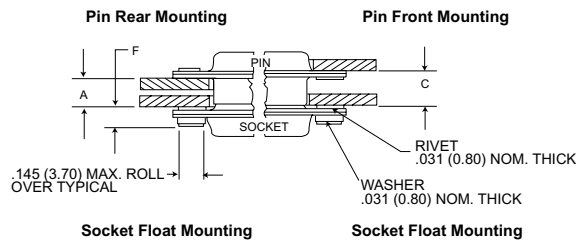

Figure 2

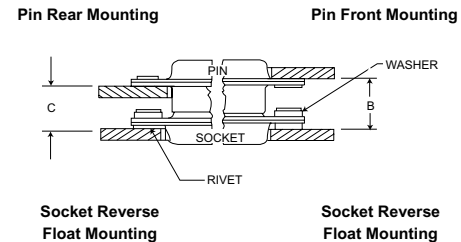

Figure 3

NOTE:

1. A, B, C and H are dimensions between panels and represent the recommended limit to be used in the design of the connector mounting method.
2. It is recommended that only one assembly, either pin or socket, be float mounted.
3. Standard pin assemblies contained .015 (0.38) thick front shells on E and A sizes; .024 (.061) thick front shells on B, C, and D sizes.
4. Standard connectors accommodate a #4 screw. Float mount connectors accommodate a #2 screw.

Fig. No.	Size	Combination of Mated Connectors		A	B	C	F	H
		Pin (See Note Below)	Socket	+ .030 (+0.76) - .000 (-0)	+ .030 (+0.76) - .000 (-0)	+ .030 (+0.76) - .000 (-0)	± .010 (±.025)	+ .030 (+0.76) - .000 (-0)
1	A, E	Standard	Standard	.250 (6.35)	.340 (8.63)	.295 (7.49)	-	.295 (7.49)
1	B, C, D	Standard	Standard	.238 (6.04)	.343 (8.71)	.298 (7.56)	-	.283 (7.18)
2	A, E	Standard	Float Mount	.218 (5.53)	-	.263 (6.68)	.120 (3.04)	-
2	B, C, D	Standard	Float Mount	.206 (5.23)	-	.266 (6.75)	.120 (3.04)	-
2	A, E	Float Mount	Standard	.218 (5.53)	-	.263 (6.68)	.120 (3.04)	-
2	B, C, D	Float Mount	Standard	.206 (5.23)	-	.251 (6.37)	.130 (3.30)	-
3	A, E	Standard	Rev. Float Mount	-	.358 (9.09)	.313 (7.95)	.120 (3.04)	-
3	B, C, D	Standard	Rev. Float Mount	-	.361 (9.16)	.301 (7.64)	.120 (3.04)	-
3	A, E	Rev. Float Mount	Standard	-	.358 (9.09)	.313 (7.95)	.120 (3.04)	-
3	B, C, D	Rev. Float Mount	Standard	-	.355 (9.01)	.310 (7.87)	.130 (3.30)	-

MIL-C-24308 Test Extracts Applicable to Class G Connectors

Test Descriptions	Requirement			Method
	Shell Size	Max Unmating (LBS)	Max Mating (LBS)	
Mating/Unmating Force	1	6	10	MIL-STD-1344 Method 2013
	2	10	17	
	3	17	28	
	4	24	39	
	5	30	49	
Contact Retention	Contacts shall be retained in their inserts by a 9 pound (minimum) force. The axial displacement of contacts shall not exceed .012 inch while under load.			MIL-STD-1344 Method 2004
Insulation Resistance	After humidity 1 Megohm (min) All other conditions 5000 Megohm (mm).			MIL-STD-1344 Method 3003
Contact Resistance	After salt spray not to exceed 55 millivolts max.			#20 AWG, 7.5 Amp MIL-STD-1344 Method 3004
Vibration	No damage and no loosening of parts due to vibration. No interruption of electrical continuity longer than 1 microsecond.			MIL-STD-1344 Method 2005 Test Cond. 4
Shock	No damage and no loosening of parts. No interruption of electrical continuity longer than 1 microsecond.			MIL-STD-1344 Method 2004 Test Cond. E
Durability	No electrical or mechanical defects after 500 cycles of mating and unmating			MIL-STD-1344 Method 2016 200 ± 100 cycles/hour
Salt Spray (Corrosion)	No exposure of base metal due to corrosion which will affect performance. Product will meet further test as specified.			MIL-STD-1344 Method 1001 Cond. B
Fluid Immersion	20 hours, immersion MIL-H-5606 Hydraulic Fluid 20 hours, immersion MIL-L-23659 Lubricating Fluid Connectors shall meet mating/unmating force following immersion.			MIL-STD-1344 Method 1016

MIL-C-39029 Crimp Contacts

Military Part Number	ITT Cannon Part Number	Contact Size	Contact Style	Product Line	MIL Specification	Pages		
M39029/4-110	030-9173-006	20	Pin	DPK, PV	MIL-C-83733 MIL-C-26482, Series 2	75-91 157-166		
M39029/4-111	030-9205-007	16	Pin	DPK, PV				
M39029/4-113	030-9185-003	12	Pin	DPK, PV				
M39029/5-115	031-9174-004	20	Soc	DPK, PV				
M39029/5-116	031-9206-006	16	Soc	DPK, PV				
M39029/5-118	031-9186-003	12	Soc	DPK, PV				
M39029/11-144	030-1975-008	22	Pin	DPX*, DPK*	MIL-C-81659	25-40		
M39029/11-145	030-1892-004	20	Pin	DPX*				
M39029/11-146	030-9083-012	16	Pin	DPX*				
M39029/11-147	030-1909-002	12	Pin	DPX*				
M39029/12-148	031-1113-008	22	Soc	DPX*				
M39029/12-149	031-1047-003	20	Soc	DPX*				
M39029/12-150	031-1271-000	16	Soc	DPX*				
M39029/12-151	031-1059-003	12	Soc	DPX*				
M39029/29-212	030-3196-008	16	Pin	MS/CV345*			MIL-C-5015	188-195
M39029/29-213	030-3197-007	12	Pin	MS/CV345*				
M39029/29-214	030-3198-003	8	Pin	MS/CV345*				
M39029/29-215	030-3199-004	4	Pin	MS/CV345*				
M39029/29-216	030-3200-003	0	Pin	MS/CV345*				
M39029/30-217	031-3113-005	16S	Soc	MS/CV345*				
M39029/30-218	031-3114-008	16	Soc	MS/CV345*				
M39029/30-219	031-3115-006	12	Soc	MS/CV345*				
M39029/30-220	031-3116-003	8	Soc	MS/CV345*				
M39029/30-221	031-3117-003	4	Soc	MS/CV345*				
M39029/30-222	031-3118-003	0	Soc	MS/CV345*				
M39029/31-228	030-9032-003	16	Pin	KPSE	MIL-C-26482, Series I	140-156		
M39029/31-240	030-9036-000	20	Pin	KPSE				
M39029/32-247	031-9095-003	16	Soc	KPSE				
M39029/32-259	031-9074-002	20	Soc	KPSE				
M39029/50-340	249-1825-001	12	Pin	DPK (Coax)	MIL-C-83733	75-91		
M39029/51-341	249-1826-000	12	Soc	DPK (Coax)				
M39029/56-348	031-1147-007	22D	Soc	KJL/KJA	MIL-C-38999, Series I, II, III	115-139		
M39029/56-351	031-1250-001	20	Soc	KJL/KJA				
M39029/56-352	031-1251-001	16	Soc	KJL/KJA				
M39029/56-353	031-1237-000	12	Soc	KJL/KJA				
M39029/57-354	031-1147-000	22D	Soc	KJ & DPK*	MIL-C-38999, Series II	122-127		
M39029/57-355	031-1122-022	22M	Soc	KJ Only				
M39029/57-356	031-1125-022	22	Soc	KJ Only				
M39029/57-357	031-1124-020	20	Soc	KJ Only				
M39029/57-358	031-1123-016	16	Soc	KJ Only				
M39029/57-359	031-1238-000	12	Soc	KJ Only				
M39029/58-360	030-2042-000	22D	Pin	KJL/KJ/KJA & DPK			MIL-C-38999, Series I, II, III	115-139
M39029/58-361	030-1993-022	22M	Pin	KJL/KJ/KJA				
M39029/58-362	030-1999-022	22	Pin	KJL/KJ/KJA				
M39029/58-363	030-1997-020	20	Pin	KJL/KJ/KJA				
M39029/58-364	030-1995-016	16	Pin	KJL/KJ/KJA				
M39029/58-365	030-2155-000	12	Pin	KJL/KJ/KJA				
M39029/63-368	031-1007-042	20	Soc	D*MA	MIL-C-24308	332-344		
M39029/64-369	330-5291-037	20	Pin	D*MA				
M39029/83-450	030-8008-800	2022	Pin	KFS-(Canada)	MIL-C-28840	218-223		
M39029/83-451	030-8009-100	2028	Pin	KFS-(Canada)				
M39029/83-508	030-8085-700	2020	Pin	KFS-(Canada)				
M39029/84-452	031-8004-300	2022	Soc	KFS-(Canada)				
M39029/84-453	031-8004-400	2028	Soc	KFS-(Canada)				
M39029/84-509	031-8005-700	2020	Soc	KFS-(Canada)				