

NO.	BESCHREIBUNG / DESCRIPTION
2	ISOLIERKÖRPER BUCHSE / INSULATOR SOCKET
6	KONTAKTBUCHSE / CONTACT SOCKET
8	DOSENGEHÄUSE / SHELL

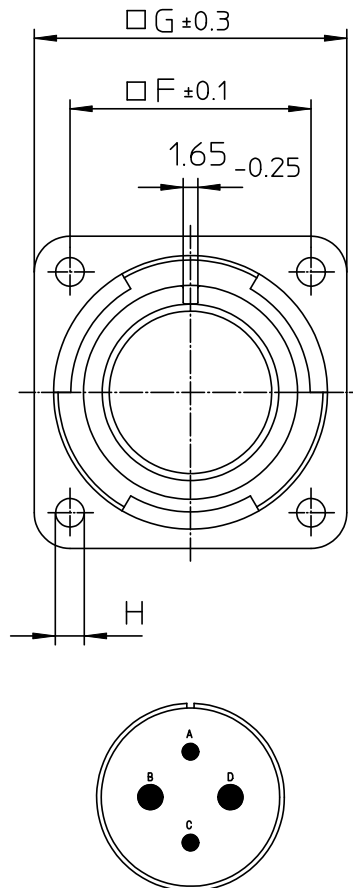

NO.	MASSE / DIMENSION
A	37.4
B	19
C	4
D	33.8
E	32.2
F	31.8
G	41
H	3.2

Note: Due to an automatic nomenclature system, numbers generated may not be sequential.
 Notiz: Durch ein automatisches Benennungssystem können Nummerierungen entstehen, die nicht fortlaufend sind.

Material Specification:	
Shell Material:	Aluminium alloy
Shell Plating:	Olive drab chromate over cadmium plating
Insulator Material:	CR-Elastomere
Contact Material:	Copper alloy
Contact Plating:	Hard silver

all dimensions are in mm
 Dimensions without tolerance indications are general tolerances in acc. with DIN7168m
 drawing for CUSTOMER



description CA3102E22-4S-B-F80
 Box mounting receptacle

AWG Crimp / Socket / Layout: 22-4

© All rights reserved. Reproduction or issue to third in any form without prior written authorization of ITT Cannon. page 1/1 revision 382.12, Apr 11