

POSITIONS	NO. OF CONTACTS SINGLE / DUAL	A		B	
		INCH	MM	INCH	MM
2	02/04	0.100	2.54	0.220	5.58
3	03/06	0.200	5.08	0.320	8.12
4	04/08	0.300	7.62	0.420	10.66
5	05/10	0.400	10.16	0.520	13.20
6	06/12	0.500	12.70	0.620	15.74
7	07/14	0.600	15.24	0.720	18.28
8	08/16	0.700	17.78	0.820	20.82
9	09/18	0.800	20.32	0.920	23.36
10	10/20	0.900	22.86	1.020	25.90
11	11/22	1.000	25.40	1.120	28.44
12	12/24	1.100	27.94	1.220	30.98
13	13/26	1.200	30.48	1.320	33.52
14	14/28	1.300	33.02	1.420	36.06
15	15/30	1.400	35.56	1.520	38.60
16	16/32	1.500	38.10	1.620	41.14
17	17/34	1.600	40.64	1.720	43.68
18	18/36	1.700	43.18	1.820	46.22
19	19/38	1.800	45.72	1.920	48.76
20	20/40	1.900	48.26	2.020	51.30
21	21/42	2.000	50.80	2.120	53.84
22	22/44	2.100	53.34	2.220	56.38
23	23/46	2.200	55.88	2.320	58.92
24	24/48	2.300	58.42	2.420	61.46
25	25/50	2.400	60.96	2.520	64.00
26	26/52	2.500	63.50	2.620	66.54
27	27/54	2.600	66.04	2.720	69.08
28	28/56	2.700	68.58	2.820	71.62
29	29/58	2.800	71.12	2.920	74.16
30	30/60	2.900	73.66	3.020	76.70
31	31/62	3.000	76.20	3.120	79.24
32	32/64	3.100	78.74	3.220	81.78
33	33/66	3.200	81.28	3.320	84.32
34	34/68	3.300	83.82	3.420	86.86
35	35/70	3.400	86.36	3.520	89.40
36	36/72	3.500	88.90	3.620	91.94
37	37/74	3.600	91.44	3.720	94.48
38	38/76	3.700	93.98	3.820	97.02
39	39/78	3.800	96.52	3.920	99.56
40	40/80	3.900	99.06	4.020	102.10

PART NUMBER CODING
xPxCxx xLFBN-RC

NUMBER OF ROWS
 1 = SINGLE ROW
 2 = DUAL ROWS

NUMBER OF POSITIONS
 (CONTACTS PER ROW, 2 THRU 40)

PLATING
 P = GOLD FLASH OVERALL
 T = TIN OVERALL

INSULATOR MATERIAL
 P = POLYESTER, UL 94V-0.
 *PROCESSING TEMP. = 210° C FOR 5 SECS.
 N = NYLON 6T.
 *PROCESSING TEMP. = 260° C FOR 10 SECS.

REVISIONS				
REV.	ECO. NO	DESCRIPTION	DATE	BY
A	648	INITIAL RELEASE	6/15/2005	TT
B	736	DIM B LETTER, PINS WIDTH	6/19/2005	TT
C	1126	UPDATE SPECIFICATIONS	6/12/2006	TT
D	1533	ADDED MIN/MAX CONTACT DEPTH DIM	10/18/2007	VJ
E	1869	UPDATE MAX CONTACT DEPTH, TOLERANCE & NOTE, ADD SINGLE ROW PCB LAYOUT	12/23/2008	JH

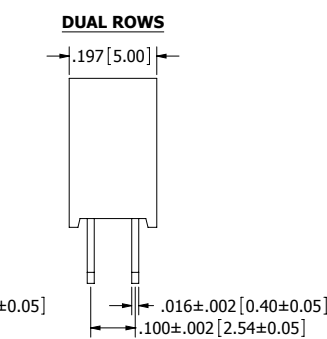
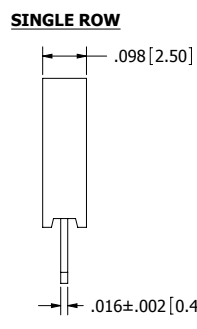
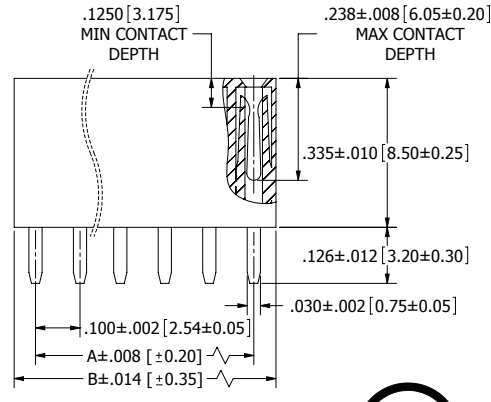
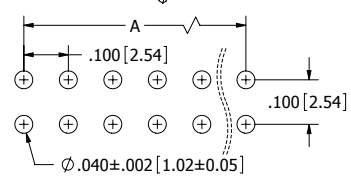
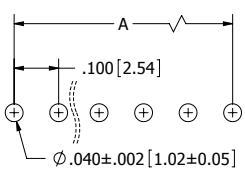
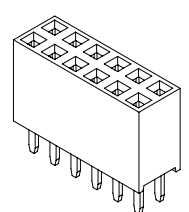
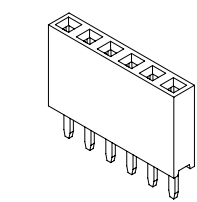
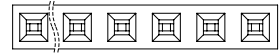
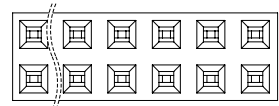

- NOTES:**
1. INSULATOR MATERIAL: SEE PART NUMBER CODING.
 2. CONTACT MATERIAL: PHOSPHOR BRONZE.
 3. CONTACT PLATING: SEE PART NUMBER CODING.
 4. CURRENT RATING: 3 AMPS
 5. INSULATOR RESISTANCE: 5000 MEGOHMS MIN.
 6. CONTACT RESISTANCE: 20 MILLIOHMS MAX.
 7. DIELECTRIC WITHSTANDING: AC 500V.
 8. OPERATING TEMPERATURE: -40° C TO +105° C.

*INDICATED TEMPERATURE AND TIME IS FOR COMPONENT INSULATOR. HIGHER PROCESSING TEMPERATURES MAY BE USED, PROVIDED HEAT IS APPLIED FROM BACK SIDE OF PCB, AND INSULATOR DOES NOT EXCEED INDICATED TEMPERATURE AND TIME.



UNLESS OTHERWISE SPECIFIED:
 DIMENSIONS ARE IN INCHES(MM)
 TOLERANCES:
 ANGULAR: ± 5°
 X = ± .012 [0.30]
 XX = ± .008 [0.20]
 XXX = ± .006 [0.15]
 SURFACE FINISH: 63 Rg
 REMOVE ALL BURRS AND SHARP EDGES .010 MAX

INTERPRET DIMENSIONS AND GEOMETRIC TOLERANCING PER: ANSI Y14.5M-1994

DATE	NAME	
12/15/08	JH	

SECTION 0101
 HEADER FEMALE, 2.54mm CC, ST

PART NUMBER
xPxCxx xLFBN-RC

SIZE	DWG. NO.	REV
C	10492	E

SCALE: 16:1
 SHEET 1 OF 1