

4

3

2

1

THIS DRAWING IS UNPUBLISHED. RELEASED FOR PUBLICATION. COPYRIGHT BY TYCO ELECTRONICS CORPORATION. ALL RIGHTS RESERVED.

LOC H DIST -

REVISIONS

P	LTR	DESCRIPTION	DATE	DWN	APVD
E	-	ECR-09-026776	09DEC2009	JvdH	TdB
-	-	-	-	-	-
-	-	-	-	-	-

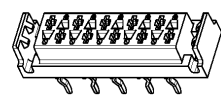
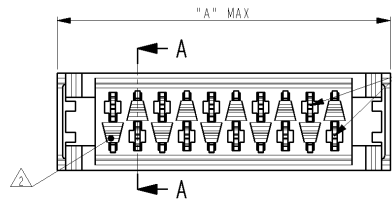

SCALE 3:1

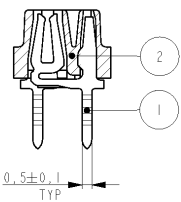
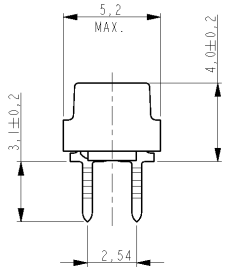

PARTNUMBER REEL PACKAGING	NR OF POS "n"	DIMENSION "A" MAX
338068-4	4	9,7
338068-6	6	12,2
338068-8	8	14,7
1-338068-0	10	17,3
1-338068-2	12	19,8
1-338068-4	14	22,4
1-338068-6	16	24,9
1-338068-8	18	27,4
2-338068-0	20	30,0

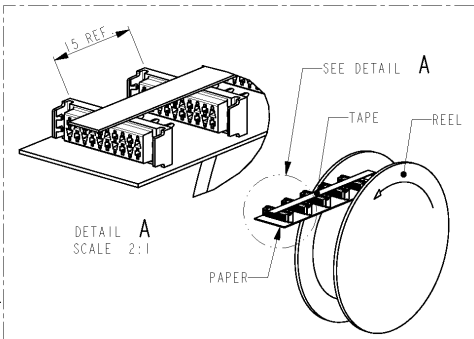
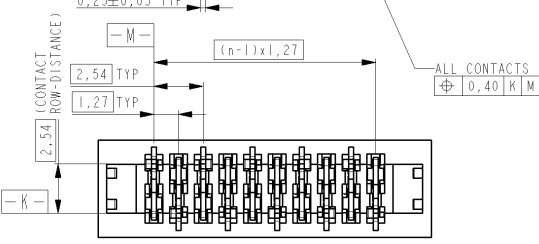

DETAIL A SCALE 2:1

REEL PACKAGING DEREELING DIRECTION AND CONNECTOR POSITION 2500 CONNECTORS PER REEL FOR ALL PARTNUMBERS

NOTES:

- IN EACH ROW, DIRECTION OF KINKS STARTS RANDOM.
- IN EACH ROW, SEQUENTIAL CONTACTS HAVE OPPOSITE KINK DIRECTIONS.
- CORING-OUTS FOR MANUFACTURING PURPOSE ONLY. SHAPE MAY VARY, BUT IS NOT FUNCTIONAL FOR THE APPLICATION.
- 3 SHOWN IS A 10 POSITION CONNECTOR.

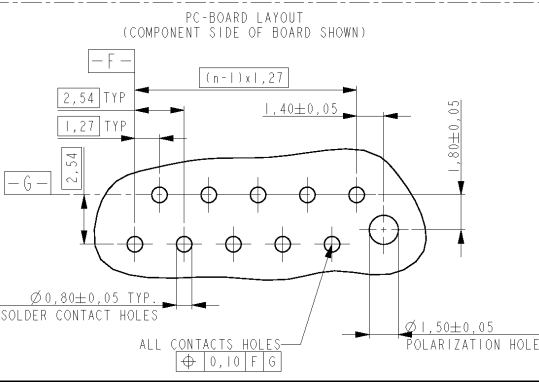

ITEM NO.	DESCRIPTION	MATERIAL	FINISH / COLOR
2	FEMALE HOUSING	G.F. POLYESTER PBT	RED
1	FEMALE CONTACT	PHOSPHOR BRONZE	TIN OVER NICKEL

DIMENSIONS: mm 		TOLERANCES UNLESS OTHERWISE SPECIFIED: 0 PLC ± 1 PLC ± 2 PLC ± 3 PLC ± 4 PLC ± ANGLES ±		DWN M. GOSSELINK CHR - APVD - NAME - PRODUCT SPEC 108-19052 APPLICATION SPEC - WEIGHT - CUSTOMER DRAWING		Tyco Electronics TYCO ELECTRONICS NEDERLAND B.V. 's-HERTOGENBOSCH, THE NETHERLANDS CONNECTOR, FEMALE-ON-BOARD TOP-ENTRY, THRU-HOLE, WITH LATCHES, Micro-MaTch SIZE A3 CAGE CODE 00779 DRAWING NO C-338068 RESTRICTED TO	
MATERIAL SEE TABLE		FINISH SEE TABLE		SCALE 5:1		SHEET 1 OF 1 REV E	

AMP 1470-19 REV 31MAR2000 Proj/ENGINEER DRAWING