

HOUSING MATERIAL: 94V-0 UNFILLED POLYESTER MATERIAL COLOR: WHITE

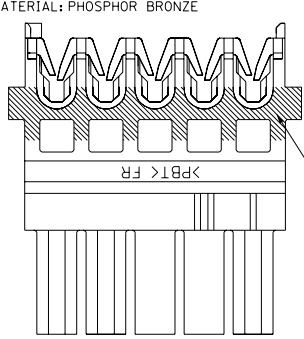
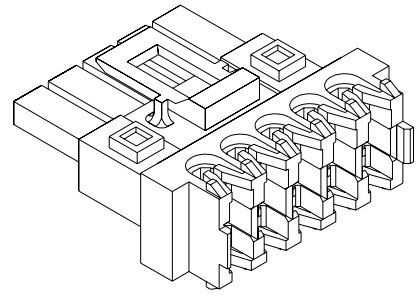
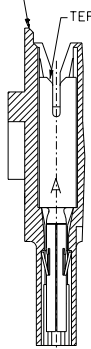
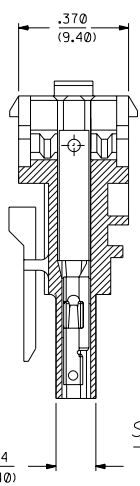

SECTION A-A SECTION B-B

NOTES:

- ASSEMBLY NO. 71694-15** SHOWN FOR ILLUSTRATION.
- MATES WITH PART NUMBER 71690-****.
- SEE FOLLOWING PAGES FOR PART NUMBERS AND THEIR CONFIGURATIONS.
- FINISHES (SEE CHART):
 TIN OVERALL - .000100/(0.00254) MINIMUM TIN OVERALL, OVER NICKEL UNDERPLATING OVERALL.
 15 GOLD - .000015/(0.00038) MINIMUM SELECT GOLD AND .000150/(0.00380) MINIMUM SELECT TIN OVER NICKEL UNDERPLATING OVERALL.
- ITEM NOS. PRECEDED BY AN *X* IN THE CHART ARE NOT AVAILABLE.
- RECOMMENDED FOR USE WITH UL STYLE # 1007 WIRE.
- PART CONFORMS TO SPECIFICATION NO. PS-71690-001.
- MATERIAL RECYCLING LOGO TO BE LOCATED ON SIDE OF PART.
- IDT SLOT IDENTIFIER COLOR STRIPE TO BE LOCATED ON THIS SURFACE. ID PER CHART BELOW.

WIRE GAUGE	ID COLOR
18	FLRSCNT MAGENTA
20	BLUE
22	GREEN
24	BLACK

- OPTIONAL COVER NUMBERS: 71161-**01 (FEED THRU) OR -**02 (FEED TO VERSION).
- SEE SMES-71690-0000 FOR TERMINATION SPECIFICATIONS.
- PACKAGE PER PK-71690-0000.

NOTE FOR LEAD FREE CONVERSION:
 THE PRIMARY SHIPPING CARTON WILL BE LABELED "COMPLIANT TO ROHS DIRECTIVE 2002/95/EC AND ELV ANNEX II OF DIRECTIVE 2000/53/EC". CARTONS WITHOUT THIS LABEL MAY CONTAIN PRODUCT WITH LEAD.

REV.	DATE	DESCRIPTION
5	N	LEAD FREE CONV
4	N	CHANGE PROD SPEC
3	N	ADD 6 CKT MIXED
2	N	ADD .010 MAX RADIUS
1	N	ADD VOIDS, MIXED AWG
		CLIST 5; NO STRIPE
		ADD CUSTOM COLOR
		MAT'L COLOR CHANGE
		18 AWG CLR CHANGE
		REVISED
		ADD WHITE MAT'L

MOLEX INCORPORATED
 68532
 DATE: 01/28/93
 SHEET NO. 1 OF 5
 TITLE: MINI-FIT IDT SINGLE ROW RECEPTACLE SALES ASSEMBLY
 PART NO. SDA-71694-****
 SEE CHART
 SCALE: 4:1
 DIMENSIONS SHOWN (METRIC) INCH
 UNLESS OTHERWISE SPECIFIED TOLERANCES ANGULAR ± 0.2°
 3 PLACE ± .010 ---
 2 PLACE ± .014 ± 0.25
 1 PLACE --- ± 0.36
 DRAFT WHERE APPLICABLE MUST REMAIN WITHIN DIMENSIONS
 ORG: RWB DWG: SAS FILE NAME: 571694X1.DWG
 APP'D: [Signature] SCALE: 4:1
 REVISIONS ONLY ON CAD SYSTEM
 NO DRAWING CONTAINS INFORMATION THAT IS PROPRIETARY TO MOLEX INC. AND SHOULD NOT BE USED WITHOUT WRITTEN PERMISSION.

CKT SIZE	STAT	ASSEMBLY ITEM NUMBER	WIRE AWG	WIRE DESCRIPTION	DIMENSION A		DIMENSION B		DIMENSION C		PLATING SEE NOTE 4
					INCH	(MM)	INCH	(MM)	INCH	(MM)	
2		71694-1001	18	SOLID,FUSED, STRANDED	.490	(12.45)	0.378	(9.60)	0.1654	(4.20)	TIN OVERALL
2		71694-1003	20		.490	(12.45)	0.378	(9.60)	0.1654	(4.20)	
2		71694-1004	22		.490	(12.45)	0.378	(9.60)	0.1654	(4.20)	
2		71694-1005	24		.490	(12.45)	0.378	(9.60)	0.1654	(4.20)	
2		71694-1007	18		.490	(12.45)	0.378	(9.60)	0.1654	(4.20)	
2		71694-1009	20		.490	(12.45)	0.378	(9.60)	0.1654	(4.20)	
2		71694-1010	22		.490	(12.45)	0.378	(9.60)	0.1654	(4.20)	
2		71694-1011	24		.490	(12.45)	0.378	(9.60)	0.1654	(4.20)	
3		71694-1101	18		.655	(16.65)	0.543	(13.80)	0.3308	(8.40)	TIN OVERALL
3		71694-1103	20		.655	(16.65)	0.543	(13.80)	0.3308	(8.40)	
3		71694-1104	22		.655	(16.65)	0.543	(13.80)	0.3308	(8.40)	
3		71694-1105	24		.655	(16.65)	0.543	(13.80)	0.3308	(8.40)	
3		71694-1107	18		.655	(16.65)	0.543	(13.80)	0.3308	(8.40)	
3		71694-1109	20		.655	(16.65)	0.543	(13.80)	0.3308	(8.40)	
3		71694-1110	22		.655	(16.65)	0.543	(13.80)	0.3308	(8.40)	
3		71694-1111	24		.655	(16.65)	0.543	(13.80)	0.3308	(8.40)	
4		71694-1301	18		.821	(20.85)	0.709	(18.00)	0.4962	(12.60)	TIN OVERALL
4		71694-1303	20		.821	(20.85)	0.709	(18.00)	0.4962	(12.60)	
4		71694-1304	22		.821	(20.85)	0.709	(18.00)	0.4962	(12.60)	
4		71694-1305	24		.821	(20.85)	0.709	(18.00)	0.4962	(12.60)	
4		71694-1307	18		.821	(20.85)	0.709	(18.00)	0.4962	(12.60)	
4		71694-1309	20		.821	(20.85)	0.709	(18.00)	0.4962	(12.60)	
4		71694-1310	22		.821	(20.85)	0.709	(18.00)	0.4962	(12.60)	
4		71694-1311	24		.821	(20.85)	0.709	(18.00)	0.4962	(12.60)	
5		71694-1501	18		.986	(25.05)	0.874	(22.20)	0.6616	(16.80)	TIN OVERALL
5		71694-1503	20		.986	(25.05)	0.874	(22.20)	0.6616	(16.80)	
5		71694-1504	22		.986	(25.05)	0.874	(22.20)	0.6616	(16.80)	
5		71694-1505	24		.986	(25.05)	0.874	(22.20)	0.6616	(16.80)	
5		71694-1507	18		.986	(25.05)	0.874	(22.20)	0.6616	(16.80)	
5		71694-1509	20		.986	(25.05)	0.874	(22.20)	0.6616	(16.80)	
5		71694-1510	22		.986	(25.05)	0.874	(22.20)	0.6616	(16.80)	
5		71694-1511	24		.986	(25.05)	0.874	(22.20)	0.6616	(16.80)	
6		71694-1701	18		1.152	(29.25)	1.039	(26.40)	0.8270	(21.00)	TIN OVERALL
6		71694-1703	20		1.152	(29.25)	1.039	(26.40)	0.8270	(21.00)	
6		71694-1704	22		1.152	(29.25)	1.039	(26.40)	0.8270	(21.00)	
6		71694-1705	24		1.152	(29.25)	1.039	(26.40)	0.8270	(21.00)	
6		71694-1707	18		1.152	(29.25)	1.039	(26.40)	0.8270	(21.00)	
6		71694-1709	20		1.152	(29.25)	1.039	(26.40)	0.8270	(21.00)	
6		71694-1710	22		1.152	(29.25)	1.039	(26.40)	0.8270	(21.00)	
6		71694-1711	24	SOLID, FUSED, STRANDED	1.152	(29.25)	1.039	(26.40)	0.8270	(21.00)	

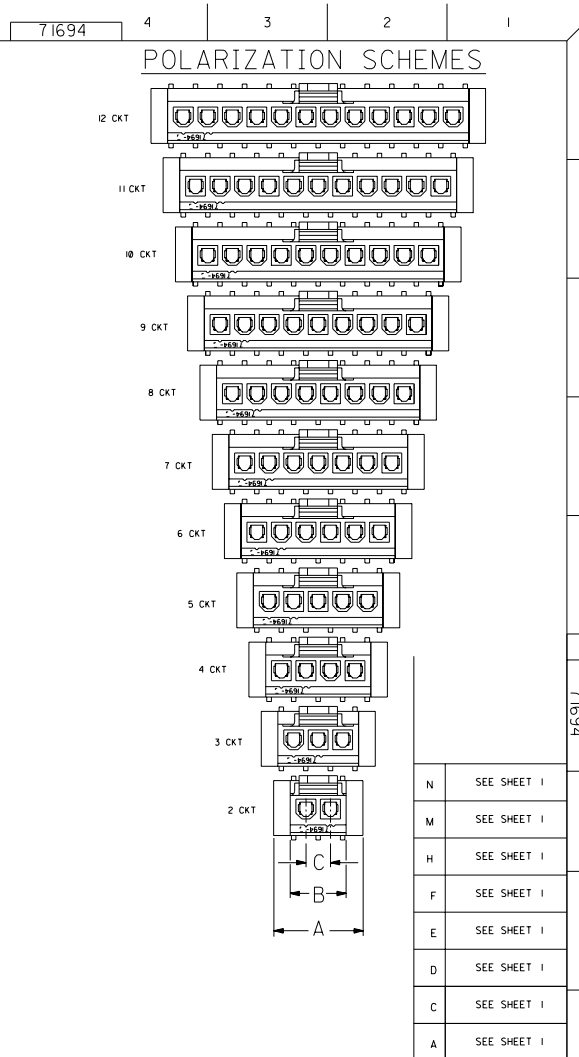

N	SEE SHEET I
M	SEE SHEET I
H	SEE SHEET I
F	SEE SHEET I
E	SEE SHEET I
D	SEE SHEET I
C	SEE SHEET I
A	SEE SHEET I

MFG, SH, REV, LTR, REVISIONS

REVISE ONLY ON CAD SYSTEM

DIMENSIONS SHOWN IN METRIC INCH	
UNLESS OTHERWISE SPECIFIED TOLERANCES ANGULAR ± 1/32°	
1 PLACE ± .010	METRIC ---
2 PLACE ± .014	± 0.25
3 PLACE ---	± 0.36
DRAFT WHERE APPLICABLE MUST REMAIN WITHIN DIMENSIONS	
DRWG. BY: RWB	CHKD. BY: SAS
APP'D. BY:	SCALE: 1

TITLE: MINI-FIT IDT SINGLE ROW RECEPTACLE SALES ASSEMBLY	
PART NO. MOLEX INCORPORATED 1515EJLL 68532	
DATE: 01/28/93	SHEET NO. 2
SEE CHART SDA-71694-****	
NO DRAWING CONTAINS INFORMATION THAT IS PROPERLY OUR TO MOLEX INC. AND SHOULD NOT BE USED WITHOUT WRITTEN PERMISSION. TC	



MOLEX INCORPORATED
LISLE, ILL. 60532 U.S.A.

WIRE TERMINATION SPECIFICATION

- 1.0 APPLICABLE DRAWINGS:
THIS SPECIFICATION APPLIES TO A-71690 AND A-71694 SERIES OF INSULATION DISPLACEMENT CONNECTORS.
- 2.0 SCOPE:
THIS SPECIFICATION IS DESIGNED TO INSURE THE PROPER TERMINATION AND PERFORMANCE OF THE A-71690 AND A-71694 SERIES OF INSULATION DISPLACEMENT CONNECTORS.
- 3.0 GENERAL:
THE .1654/(4.20) CENTER INSULATION DISPLACEMENT CONNECTOR SYSTEM IS DESIGNED TO INTERCONNECT DISCRETE WIRE AS OUTLINED IN THIS SPECIFICATION.

4.0 CONDUCTOR REQUIREMENTS:

4.1 CONDUCTOR SIZE IDENTIFICATION:

CONDUCTOR SIZE	CONDUCTOR STYLE	HOUSING ID COLOR (SEE FIG. 4)	TERMINAL ID HOLE POSITION (SEE FIG.8; SHT.5)
18 AWG	STRANDED WITH TOPCOAT,FUSED, SOLID	RED	POSITION 1
20 AWG	STRANDED WITH TOPCOAT,FUSED, SOLID	BLUE	POSITION 2
22 AWG	STRANDED WITH TOPCOAT,FUSED, SOLID	GREEN	POSITION 3
24 AWG	STRANDED WITH TOPCOAT,FUSED, SOLID	BLACK	POSITION 4

RECOMMENDED UL STYLE: 1007, 1061

4.2 INSULATION REQUIREMENTS:

INSULATION DIAMETER: .090 MAX
INSULATION HARDNESS: 85 MAX ON THE SHORE A SCALE

5.0 TERMINATION REQUIREMENTS:

5.1 CABLE INSERTION DEPTH:

THE CABLE SHOULD BE INSERTED TO DEPTH OF .140/(3.56)* FROM THE TOP OF THE HOUSING TO THE TOP OF THE WIRE (SEE FIGURE 2). WIRE MUST BE LOCATED BELOW THE BOTTOM OF EAGLES.

* TERMINATION DEPTH FOR THE 24 AWG WIRES IN THE FOLLOWING ASSEMBLIES TO BE .138±.005/(3.51±0.13); 71690-6008 AND 71694-2402.

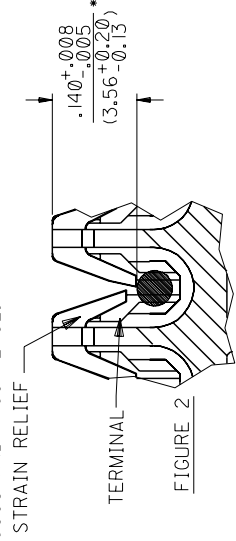

REV.	B	A	B	B	B
SHT.	1	2	3	4	5

FILE NAME: T71690X1
 = 0
 = 0

REVISE ONLY ON CAD SYSTEM

REV. B

THIS DRAWING CONTAINS INFORMATION THAT IS PROPRIETARY TO MOLEX INC. AND SHOULD NOT BE USED WITHOUT WRITTEN PERMISSION.

SHT. 1 OF 5

DRWG. NO. SMES-71690-0000

DRWG. NO. SMES-71690-0000



WIRE TERMINATION SPECIFICATION

5.2 WIRE CUT OFF

IN THE FEED-TO VERSION THE WIRE MUST BE DISPLACED IN BOTH INSULATION DISPLACEMENT SLOTS AND MUST PROTRUDE THROUGH THE SECONDARY SLOT BY (1.52)/.060 MIN. AS SHOWN IN FIGURE 3.

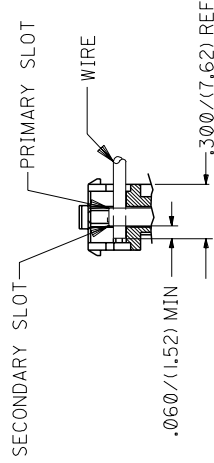

FIGURE 3

5.3 HORIZONTAL PULL OUT FORCE

THE CONNECTOR MUST MAINTAIN THE FOLLOWING MIN. PULL OUT VALUES WHEN A FORCE IS APPLIED AT A RATE OF 1 INCH PER MINUTE TO THE CABLE IN A DIRECTION PERPENDICULAR TO THE INSULATION DISPLACEMENT SECTION, AS SHOWN IN FIGURE 4. (NOTE CABLE MUST BE SLIT TO FORM INDIVIDUAL CONDUCTORS AFTER TERMINATION BUT PRIOR TO TESTING).

AWG	PULL FORCE
18 AWG	14.0 LBS. MIN.
20 AWG	TBD
22 AWG	TBD
24 AWG	8.0 LBS. MIN.

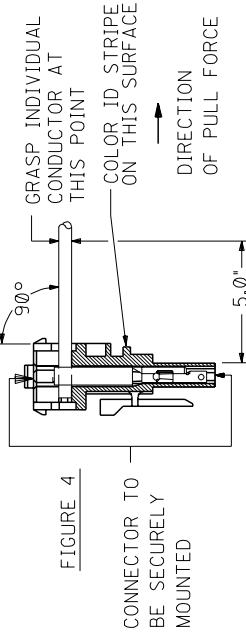

FIGURE 4

CONNECTOR TO BE SECURELY MOUNTED

5.4 VERTICAL PULL OUT FORCE

THE CONNECTOR MUST MAINTAIN THE FOLLOWING MIN. PULL OUT VALUES WHEN A FORCE IS APPLIED AT A RATE OF 1 INCH PER MINUTE TO THE CABLE IN A DIRECTION PARALLEL TO THE INSULATION DISPLACEMENT SECTION, AS SHOWN IN FIGURE 5. (NOTE CABLE MUST BE SLIT TO FORM INDIVIDUAL CONDUCTORS AFTER TERMINATION BUT PRIOR TO TESTING).

AWG	PULL FORCE
18 AWG	5.0 LBS. MIN.
20 AWG	TBD
22 AWG	TBD
24 AWG	2.4 LBS. MIN.

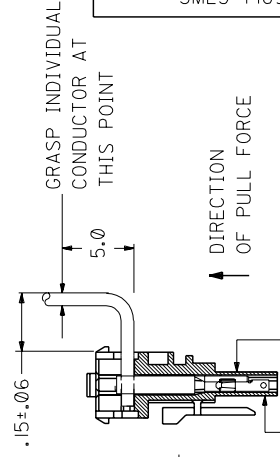

FIGURE 5

CONNECTOR TO BE SECURELY MOUNTED

REV.

SHT.

FILE NAME
T71690X2

REVISE ONLY ON CAD SYSTEM

REV. A

SHT. 2

DRWG. NO. SMES-71690-0000

DRWG. NO. SMES-71690-0000

THIS DRAWING CONTAINS INFORMATION THAT IS PROPRIETARY TO MOLEX INC. AND SHOULD NOT BE USED WITHOUT WRITTEN PERMISSION.



MOLEX INCORPORATED
LISLE, ILL. 60532 U.S.A.

WIRE TERMINATION SPECIFICATION

5.5 TORSIONAL RESISTANCE:
CONNECTOR MUST WITHSTAND A MAXIMUM TWIST OF 130° WITHOUT DISTURBING THE INSULATION DISPLACEMENT INTERFACE IN THE PRIMARY OR SECONDARY SLOTS (SEE FIGURE 3) (NOTE CABLE MUST BE SLIT TO FORM INDIVIDUAL CONDUCTORS AFTER TERMINATION BUT PRIOR TO TESTING).

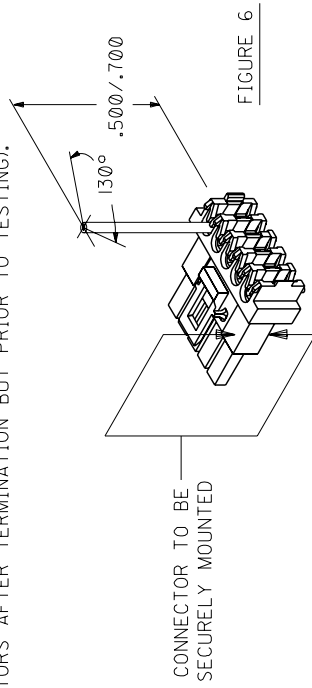

FIGURE 6

5.6 VISUAL INSPECTION:
AFTER TERMINATION, INSULATION DISPLACEMENT SECTION OF THE TERMINAL TO BE FREE OF TOOL MARKS FROM TERMINATION EQUIPMENT.

6.0 TERMINATION EVALUATION PROCEDURE:

STEP 1 - STRAIN RELIEF REMOVAL
REMOVE SHADED PORTION OF THE STRAIN RELIEF USING A RAZOR BLADE

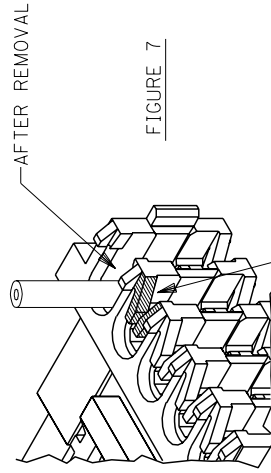

FIGURE 7

STEP 2 - REMOVAL OF TERMINAL
INSERT THE REMOVAL TOOL (#HT60630A) INTO THE FRONT OF OF THE CONNECTOR (AROUND THE TERMINAL) TO DEPRESS LOCK TANGS. PUSH THE TERMINAL/WIRE OUT THE BACK OF THE CONNECTOR.

DRWG. NO. SMES-71690-0000

REV.
SHT.

FILE NAME
T71690X3

REVISION SYMBOL = 0

REVISE ONLY ON CAD SYSTEM

REV. B
SHT. 3

THIS DRAWING CONTAINS INFORMATION THAT IS PROPRIETARY TO MOLEX INC. AND SHOULD NOT BE USED WITHOUT WRITTEN PERMISSION.

DRWG. NO. SMES-71690-0000



MOLEX INCORPORATED
LISLE, ILL. 60532
U.S.A.

WIRE TERMINATION SPECIFICATION

STEP 3 -CONDUCTOR REMOVAL
USING A SMALL PAIR OF PLIERS SPREAD THE I.D.T. SLOT
AND REMOVE CONDUCTOR BY PUSHING IN DIRECTION SHOWN

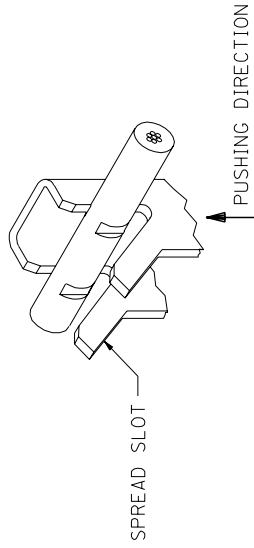

STEP 4 -REMOVING INSULATION
INSULATION TO BE REMOVED WITHOUT DISTURBING I.D.T. AREA

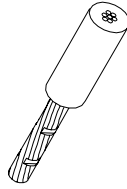

STEP 5 -CONDUCTOR INSPECTION
FOUR DEFORMATION POINTS MUST BE CLEARLY VISIBLE WHEN
USING 10X MAGNIFICATION

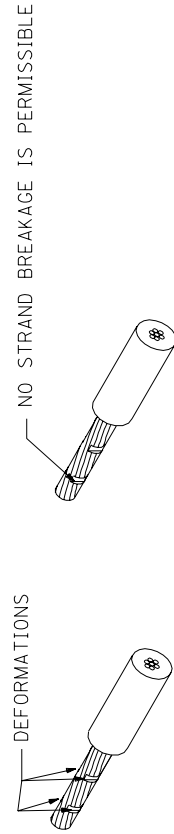

DRWG. NO. SMES-71690-0000

REV.
SHT.

FILE NAME
T71690X4

▽ = 0 ▲ = 0

REVISE ONLY ON CAD SYSTEM

REV. B
SHT. 4

THIS DRAWING CONTAINS INFORMATION THAT IS PROPRIETARY TO
MOLEX INC. AND SHOULD NOT BE USED WITHOUT WRITTEN PERMISSION.

DRWG. NO. SMES-71690-0000



MOLEX INCORPORATED
 LISLE, ILL. 60532
 U.S.A.

WIRE TERMINATION SPECIFICATION

LTR.	REVISIONS
A	RELEASED PER ECR U51189 09/15/95 sas
B	UPDATED PER ECR U70308 ELO 09/20/96

STEP 1 -REMOVAL OF TERMINAL

INSERT THE REMOVAL TOOL(#HT60630A) INTO THE FRONT OF OF THE CONNECTOR (AROUND THE TERMINAL) TO DEPRESS LOCK TANGS.
 PUSH THE TERMINAL/WIRE OUT THE BACK OF THE CONNECTOR.

STEP 2 -WIRE GAGE PER CHART

ID LETTER	WIRE GAGE
D	18 AWG
C	20 AWG
B	22 AWG
A	24 AWG

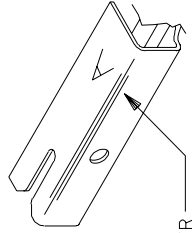

ID LETTER

FIGURE 8

DRWG. NO. SMES-7 1690-0000

REV.
SHT.
T71690X5

DRWG. NO. SMES-7 1690-0000

REV. B
SHT. 5

REVISE ONLY ON CAD SYSTEM

THIS DRAWING CONTAINS INFORMATION THAT IS PROPRIETARY TO MOLEX INC. AND SHOULD NOT BE USED WITHOUT WRITTEN PERMISSION.