

SR

## I.D.C SOCKET DUAL-ROW

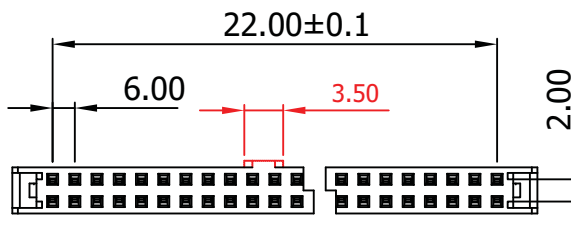
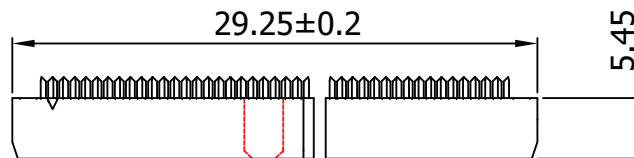
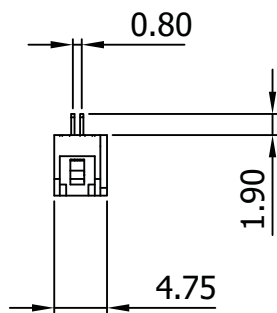
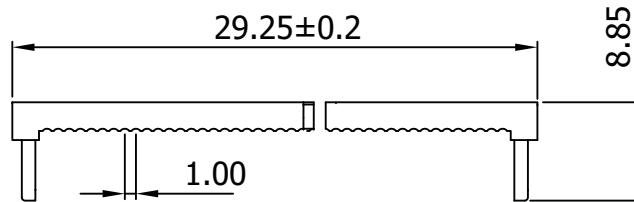
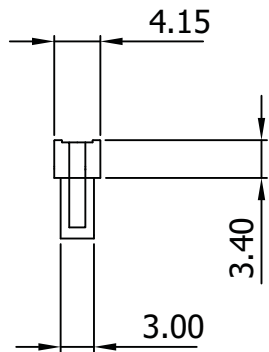

### Material:

- Insulator: P.B.T. 30% Glass Fiber, UL 94V-0
- Contact Material: Phosphor Bronze, Gold flash over Nickel

### Electrical:

- Current Rating: 1Amp DC
- Insulation Resistance: 1,000MΩ Min.
- Dielectric Withstanding: 500V AC
- Operating Temperature: -55°C ~ +105°C

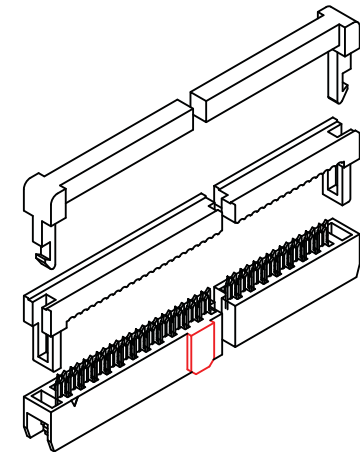

Unit: MM±0.30MM

Ⓜ = Assmann logo



ITEM NO.

**AWP2-24-7241-T-R**

TITLE

IDC Socket - 2.00MM Pitch, Gold flash,  
Central Lug w/Strain Relief, 24 Contacts

**ASSMANN**  
Electronics, Inc.

1840 W. Drake Drive, Suite 101 • Tempe, AZ 85283  
Toll Free: 1-877-277-6266 • Email: info@usa-assmann.com

THIS DRAWING IS UNPUBLISHED  
©Copyright 2010 by Assmann Electronic Components  
All International Rights Reserved