

SR

I.D.C SOCKET DUAL-ROW

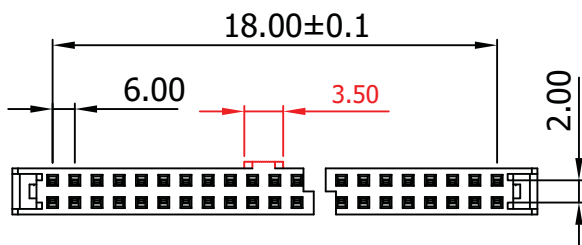
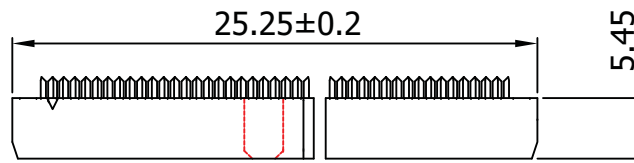
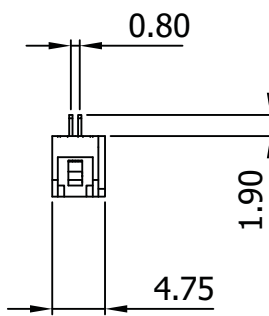
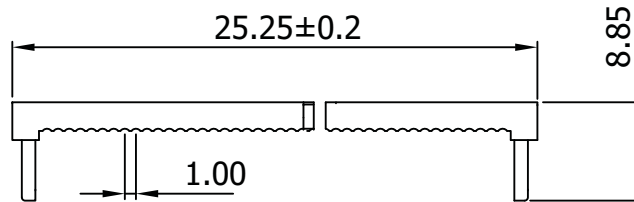
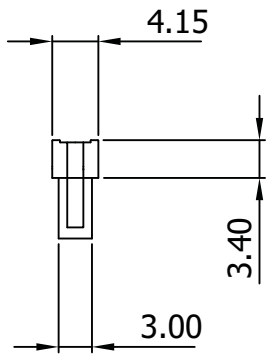

Material:

- Insulator: P.B.T. 30% Glass Fiber, UL 94V-0
- Contact Material: Phosphor Bronze, Gold flash over Nickel

Electrical:

- Current Rating: 1Amp DC
- Insulation Resistance: 1,000MΩ Min.
- Dielectric Withstanding: 500V AC
- Operating Temperature: -55°C ~ +105°C

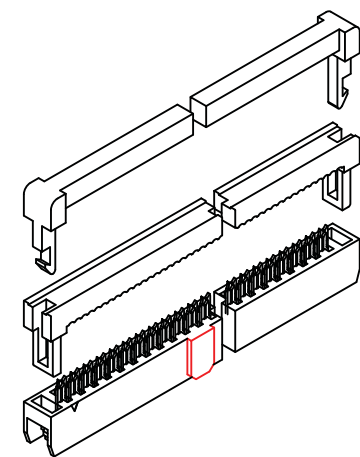

Unit: MM±0.30MM

Ⓜ = Assmann logo



ITEM NO. **AWP2-20-7241-T-R**

TITLE IDC Socket - 2.00MM Pitch, Gold flash, Central Lug w/Strain Relief, 20 Contacts

ASSMANN
Electronics, Inc.

1840 W. Drake Drive, Suite 101 • Tempe, AZ 85283
Toll Free: 1-877-277-6266 • Email: info@usa-assmann.com

THIS DRAWING IS UNPUBLISHED
©Copyright 2010 by Assmann Electronic Components
All International Rights Reserved