

I.D.C. Socket Dual-Row, No SR

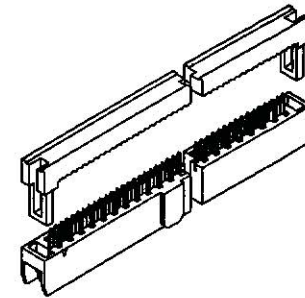
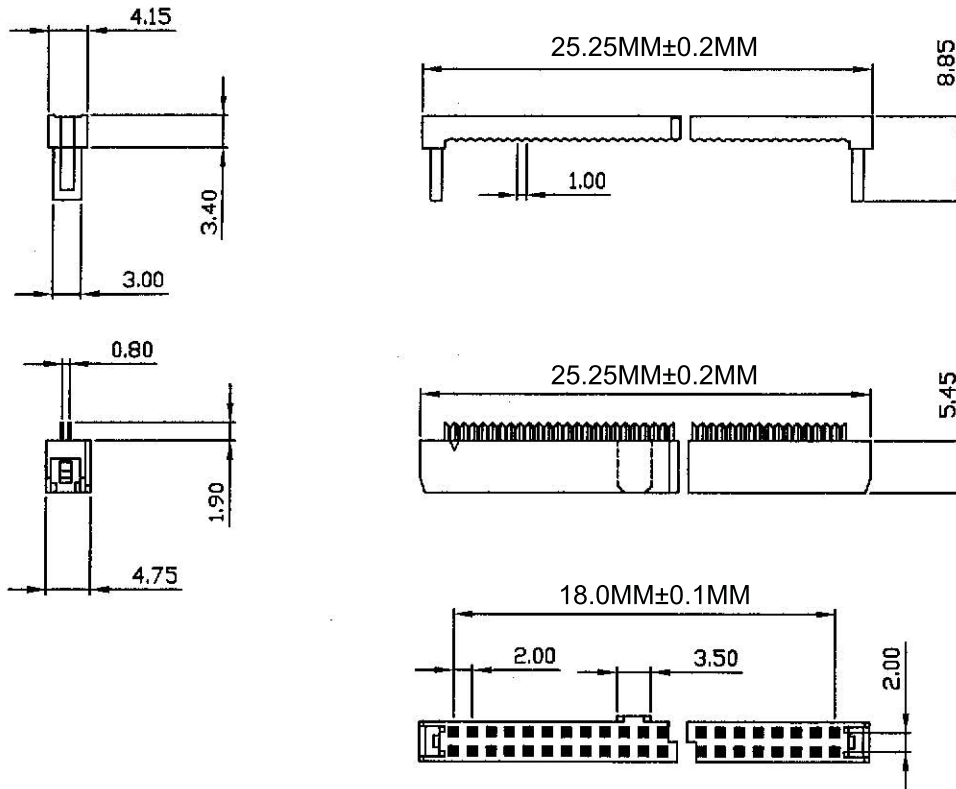

Unit: MM±0.3MM

Materials:

- Insulator: P.B.T. 30% Glass Fiber, UL94V-0
- Contact Material: Phosphor Bronze
- Gold Flash over Nickel

Electrical:

- Current Rating: 1 Amp
- Insulation Resistance: 1,000MΩ Min.
- Dielectric Withstanding, 500V AC
- Operating Temperature: -55°C ~ +105°C

⊕ = Assmann Logo

RoHS
Compliant

ITEM NO

AWP2-20-7240-T-R

TITLE

IDC Socket - Pitch 2.0MM, 20 Contacts,
Central Guide Lug w/o Strain Relief, Gold Flash

ASSMANN
Electronics, Inc.

1840 W. Drake Drive, Suite 101 - Tempe, AZ 85283

Toll Free: 1-877-277-6266 Email: info@usa-assmann.com

THIS DRAWING IS UNPUBLISHED

© Copyright 2010 by Assmann Electronic Components
All International Rights Reserved