

20 19 18 17 16 15 14 13 12 11 10 9 8 7 6 5 4 3 2 1

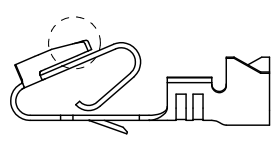

ALTERNATE GEOMETRY
SEE NOTE 10

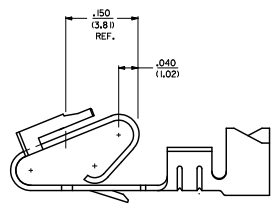

SELECTIVE PLATING
LOCATION

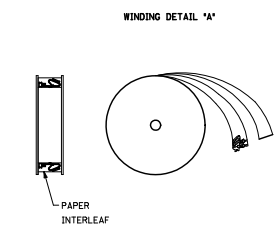

WINDING DETAIL "A"

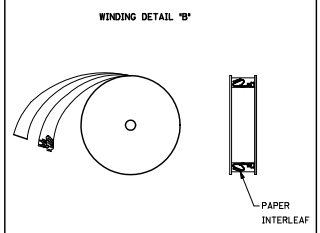

WINDING DETAIL "B"

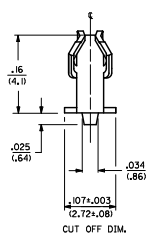
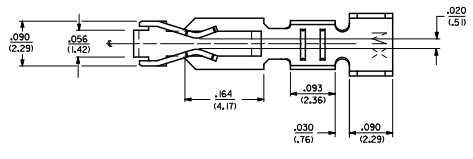

CUT OFF DIM.

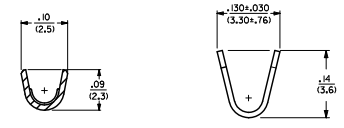
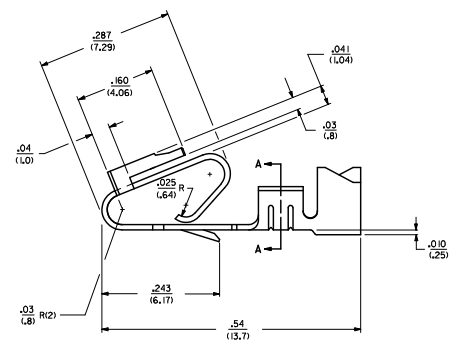

SECTION A-A

LEGEND: 6838- ()
 MATERIAL: L27V.0106 THK
 BLANK=BRASS
 A=PHOS BRONZE
 WINDING
 A= PER DETAIL A
 BLANK= PER DETAIL B
 FORM
 BLANK= CHAIN
 L= LOOSE
 PLATING
 SEE NOTE 2

- NOTES:
 1. MATERIAL: SEE LEGEND
 2. FINISH:
 909 - OVERALL HOT TIN DIP: .000100/(0.00254) MIN.
 102 - OVERALL TIN: .000200/(0.00508) MIN.
 OVERALL COPPER: .000100/(0.00254) MIN.
 132 - OVERALL TIN: .000200/(0.00508) MIN.
 OVERALL COPPER: .000200/(0.00508) MIN.
 503 - OVERALL HARD GOLD: .000300/(0.0076) MIN.
 OVERALL NICKEL: .000050/(0.00127) MIN.
 550 - SELECT HARD GOLD: .000150/(0.0038) MIN.
 OVERALL NICKEL: .000030/(0.00076) MIN.
 OVERALL HARD GOLD FLASH: .000002/(0.00005) MIN.
 555 - SELECT HARD GOLD: .000150/(0.0038) MIN.
 OVERALL NICKEL: .000030/(0.00076) MIN.
 558 - SELECT HARD GOLD: .000030/(0.00076) MIN.
 OVERALL HARD GOLD FLASH: .000002/(0.00005) MIN.
 OVERALL NICKEL: .000050/(0.00127) MIN.
 561 - SELECT HARD GOLD: .000030/(0.00076) MIN.
 OVERALL NICKEL: .000050/(0.00127) MIN.
 3. PRODUCT SPECIFICATION: PS-40-02
 4. PACKAGING SPECIFICATION: CHAIN FORM SEE PK-6838-001
 LOOSE FORM SEE PK-2759-001
 5. TERMINAL FOR USE IN HOUSING SERIES 6442 AND 4995.
 6. SEE 7258 SERIES FOR THIS PART WITH CRIMP FOR 22-26 AWG WIRE.
 7. CRIMP FOR 18 TO 20 GA. WIRE WITH MAX. INSULATION DIA. OF .100/(2.79).
 STRIP LENGTH OF .125/.100 / (3.18/2.54)
 8. DIMENSIONS GIVEN ACROSS CENTERLINES ARE SYMMETRICAL ABOUT THOSE CENTERLINES WITHIN HALF THE TOTAL TOLERANCE.
 9. THIS PART CONFORMS TO CLASS B REQUIREMENTS OF COSMETIC SPECIFICATION PS-45499-002.
 10. ALTERNATE GEOMETRY PRESENT ON SOME PART NUMBERS. SEE SHEET 2.

ADD. ALT. GEOMETRY ERS: 11/15/89 CHROMKOPFER 2011/09/14 CHYKOSOUSEK 2011/02/23 APPROV: SMTH 2011/02/23 REV	QUALITY SYMBOLS	GENERAL TOLERANCES (UNLESS SPECIFIED)	DIMENSION STYLE	SCALE	DESIGN UNITS	THIRD ANGLE PROJECTION	
	4 PLACES ± --- ± --- 3 PLACES ± --- ± --- 2 PLACES ± 0.25 ± 0.15 1 PLACE ± 0.36 ± --- ANGULAR ± 1/2°	MIN INCH ± --- ± --- ± 0.10 ± 0.15 ± --- ± ---	IN/MM 11/15/89 11/15/89	QUZIK PATEL LENZ	DATE DATE DATE	INCH INCH	TRIFURCON TERMINAL CRIMP TYPE, .156 CENTERS 18 TO 20 AWG WIRE
	DRAFT WHERE APPLICABLE MUST REMAIN WITHIN DIMENSIONS	SEE CHART SD-6838	MATERIAL NO. DOCUMENT NO.	MOLEX INCORPORATED	SHEET NO. 1 OF 2	THIS DRAWING CONTAINS INFORMATION THAT IS PROPRIETARY TO MOLEX INCORPORATED AND SHOULD NOT BE USED WITHOUT WRITTEN PERMISSION	

6838-(*)**			6838-A(*)**		
PART NO.	ENG. NO.		PART NO.	ENG. NO.	
08-50-0187	6838-(P909)	SEE NOTE 1	08-58-0187	6838-A(P558)	
08-50-0189	6838-(P909)L	SEE NOTE 1	08-58-0189	6838-A(P558)L	
08-50-0275	6838-(P909)-A		08-60-0001	6838-A(132)	
08-50-0026	6838-(P102)		08-60-0002	6838-A(132)L	
	6838-(P102)L		08-58-0102	6838-A(558)	
08-50-0028	6838-(102)			6838-A(558)L	
08-50-0029	6838-(102)L		08-58-0108	6838-A(503)	
			08-58-0109	6838-A(503)L	
			08-52-0112	6838-A(P909)	SEE NOTE 1
			08-52-0113	6838-A(P909)L	SEE NOTE 1
			08-50-0024	6838-A(102)	
			08-50-0251	6838-A(102)L	
			08-58-0105	6838-A(P555)	
			08-58-0106	6838-A(P555)L	
			08-58-0110	6838-A(P561)	SEE NOTE 1
			08-58-0111	6838-A(P561)L	SEE NOTE 1
			08-58-0118	6838-A(561)	
			08-58-0119	6838-A(561)L	
			08-58-0131	6838-A(550)	
			08-58-0132	6838-A(550)L	

NOTES:
 1. PART MANUFACTURED WITH ALTERNATE GEOMETRY. SEE SHEET 1.

ADD. ALT. GEOMETRY ENG. NO. 11/15/89 DRAWN BY GUZIK CHECKED BY PATEL APPROVED BY LENZ DATE 11/15/89	QUALITY SYMBOLS	GENERAL TOLERANCES (UNLESS SPECIFIED)		DIMENSION STYLE	SCALE	DESIGN UNITS	THIRD ANGLE PROJECTION
	▽=0	mm	INCH	IN/MM	---	INCH	
	▽=0	4 PLACES ±---	±---	DRAWN BY GUZIK	DATE 11/15/89	TITLE	TRIFURCON TERMINAL
		3 PLACES ±---	±---	CHECKED BY PATEL	DATE 11/15/89		CRIMP TYPE, .156 CENTERS
	2 PLACES ±---	±---	APPROVED BY LENZ	DATE 11/15/89			18 TO 20 AWG WIRE
	1 PLACE ±---	±---					MOLEX INCORPORATED
		ANGULAR ±1/2°					
		DRAFT WHERE APPLICABLE		MATERIAL NO.	DOCUMENT NO.		SHEET NO.
		MUST REMAIN WITHIN DIMENSIONS		SEE CHART	SD-6838		2 OF 2
				THIS DRAWING CONTAINS INFORMATION THAT IS PROPRIETARY TO MOLEX INCORPORATED AND SHOULD NOT BE USED WITHOUT WRITTEN PERMISSION			