

10 9 8 7 6 5 4 3 2 1

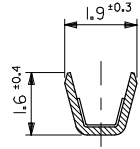

断面 A-A
SECT. A-A

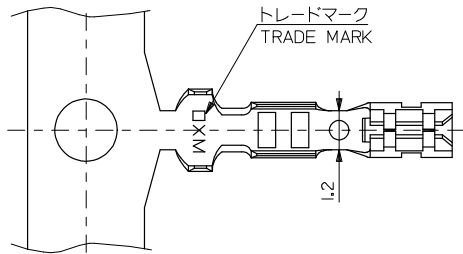
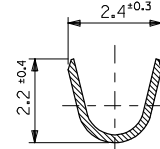

断面 B-B
SECT. B-B

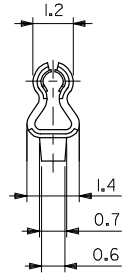
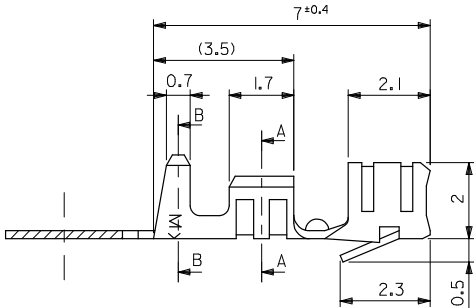

注記
NOTE

1. 材質：リン青銅 (t=0.203)
MATERIAL : PHOSPHOR BRONZE
2. メッキ：前錫メッキ
FINISH : PRE TINNED
3. 使用ハウジング：5264シリーズ
SUITABLE HOUSING : 5264 SERIES
4. 適用電線範囲：AWG#22~28 (0.33 ~ 0.08mm²)
WIRE RANGE : AWG #22-28(0.33 - 0.08mm²)
5. 被覆外形：φ1.15 ~ φ1.9
INSULATION RANGE : φ 1.15 - φ1.9

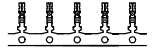
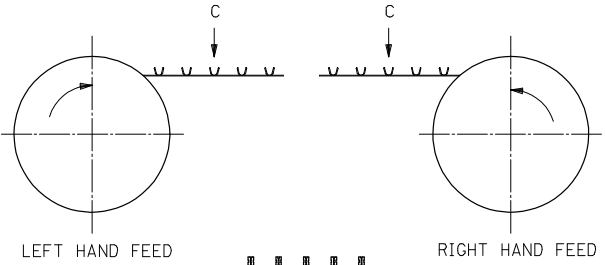

RIGHT HAND	39-00-0159	5263PBTR	連続状 CHAIN
LEFT HAND	08-70-1040	5263PBTL	バラ状 LOOSE
	08-70-1039	5263PBT	連続状 CHAIN
FEED TYPE	EDP NO.	ENG. NO.	端子形状 FORM

REVISED EC NO: J2008-4450 T: 08/07/01 DRAWN BY: CHYKOKIYODA CHKD BY: APPR: NUKITA 2008/07/02	GENERAL TOLERANCES (UNLESS SPECIFIED)		DIMENSION STYLE MM ONLY	SCALE 10:1	DESIGN UNITS METRIC	MODEL NO. 5263PBT*	THIRD ANGLE PROJECTION
	10 UNDER	±0.2	DRAWN BY K. TOJO	DATE '91/07/19	TITLE 2.5 LOW PROFILE CRIMP RECEPTACLE		
	10 OVER 30 UNDER	±0.25	CHECKED BY M. FUKUSHIMA	DATE '91/08/09	MOLEX INCORPORATED		
	30 OVER	±0.3	APPROVED BY M. ENOMOTO	DATE '91/08/09	DOCUMENT NO. SD-5263-003		
ANGULAR ±3°		DRAFT WHERE APPLICABLE MUST REMAIN WITHIN DIMENSIONS	MATERIAL NO. SEE TABLE	SHEET NO. 1 OF 1			
SIZE A3 THIS DRAWING CONTAINS INFORMATION THAT IS PROPRIETARY TO MOLEX INCORPORATED AND SHOULD NOT BE USED WITHOUT WRITTEN PERMISSION							