

10 9 8 7 6 5 4 3 2 1

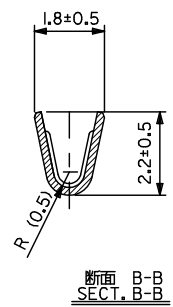

注記
NOTES

- 適合ハウジング アッセンブリ; 52266-***
APPLICABLE HS'G ASS'Y; 52266-***
- 嵌合相手; 50148-8*00
MATES WITH; 50148-8*00

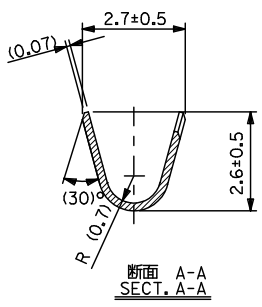
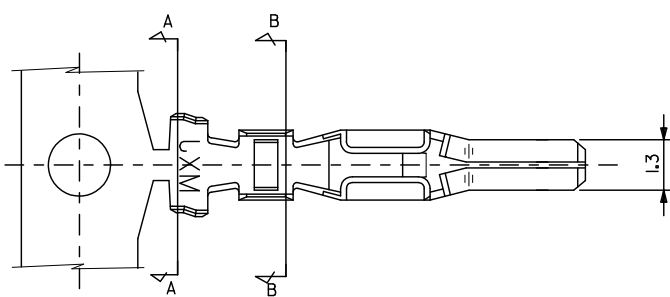
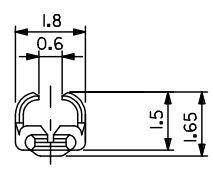
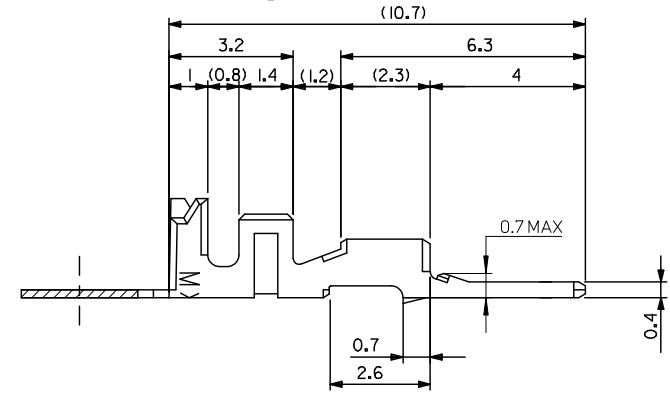

50147-8100	バラ状 LOOSE
50147-8000	連鎖状 CHAIN
製品番号 ENG.NO.	端子形状 FORM

材料 MATERIAL	リン青銅 錫メッキ(+0.2) PHOSPHOR BRONZE TIN PLATING(+0.2)
適用電線範囲 WIRE RANGE	AVSS-0.3 AVSS-0.5 CAVS-0.3 CAVS-0.5
被覆外径 INS. RANGE	φ1.4-1.7

REVISED & REDRAWN EC NO: JTR2010-0004 DRAWN: MISHIBATA 2009/07/28 CHKD: AITO 2009/07/28 APPR: MAYAMOTO 2009/07/28	GENERAL TOLERANCES (UNLESS SPECIFIED)		DIMENSION STYLE MM ONLY		SCALE 10:1	DESIGN UNITS METRIC	THIRD ANGLE PROJECTION	
	10 UNDER	±0.3	DRAWN BY M. SANO	DATE 1991/11/17	TITLE 2.5 MINI SPLASH PROOF CONN. CRIMP PIN.			
	10 OVER 30 UNDER	±0.25	CHECKED BY M. SAKANO	DATE 1992/18/16				
	30 OVER	±0.2	APPROVED BY M. ENOMOTO	DATE 1992/18/16	MOLEX INCORPORATED		SHEET NO. 1 OF 1	
ANGULAR ±3 °		DRAFT WHERE APPLICABLE MUST REMAIN WITHIN DIMENSIONS		MATERIAL NO. SEE CHART		DOCUMENT NO. SD-50147-8*00		

tb_frame_A3_J_AM_S
Rev. E 2006/04/15

EN-02DA(021)

ENG. NO. SD-50147-8*00
EDP NO.

MM DIMENSIONS IN METRIC DO NOT SCALE DRAWING

8 7 6 5 4 3 2 1

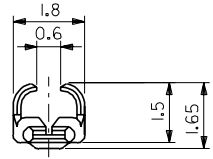
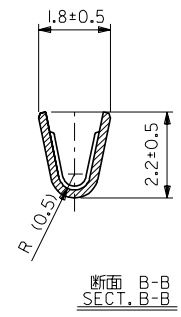
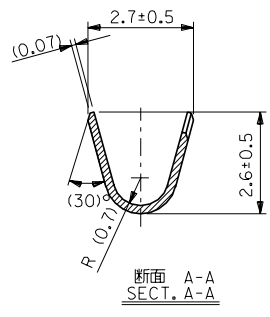
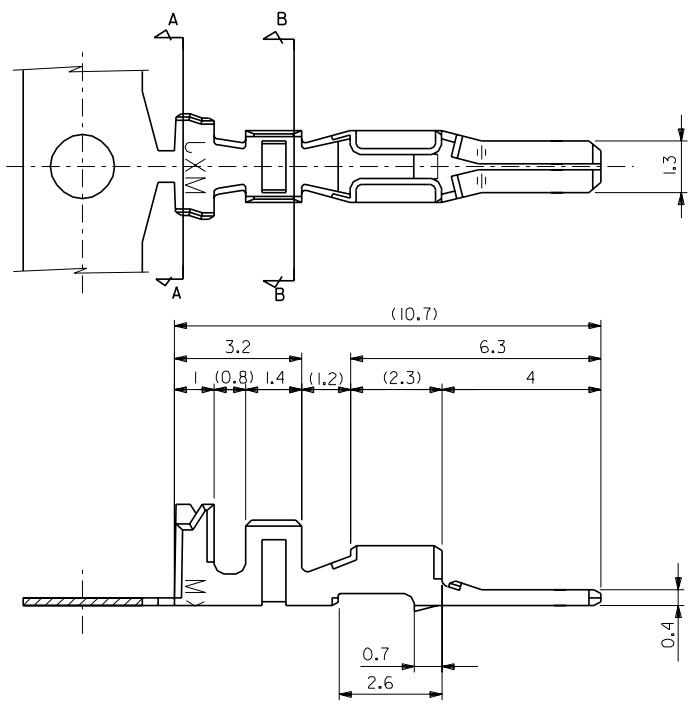

注記
NOTES

- 適合ハウジング アッセンブリ; 52266-***
APPLICABLE HS'G ASS'Y; 52266-***
- 嵌合相手; 50148-8*00
MATES WITH; 50148-8*00

50147-8100	バラ状 LOOSE
50147-8000	連鎖状 CHAIN
製品番号 ENG.No.	端子形状 FORM

角度 ANGLE		±3°			材料 MATERIAL リン青銅 鍍メッキ (t=0.2) PHOSPHOR BRONZE TIN PLATING (t=0.2)		MOLEX-JAPAN CO.,LTD. 日本モレックス株式会社	
30以上 OVER	±0.3	A	変更 REVISED (J20708)	92/8/6	仕上げ FINISH		EDP NO.	
10以上 未満 OVER 30 UNDER	±0.25	O	新案作成 PROPOSED (J10601)	91/8/20	適用電線範囲 WIRE RANGE AVSS-0.3 AVSS-0.5 CAVS-0.3 CAVS-0.5		ENG. NO. SD-50147-8*00	
10未満 UNDER	±0.2	記号 LTR	変更内容 REVISION RECORD	DR. CHK. DATE	被覆外径 INS. RANGE φ 1.4-1.7		REV A	
一般公差 GENERAL TOLERANCES		REVISION ONLY ON CAD SYSTEM			DRAWN BY M.SAKANO		TITLE 名称 2.5 MINI SPLASH PROOF CONN. CRIMP PIN.	
					APPR'D BY M.ENOMOTO		CHECKED BY M.SAKANO	
					尺度 SCALE 10-1			

THIS DRAWING CONTAINS INFORMATION THAT IS PROPRIETARY TO MOLEX/JAPAN AND SHOULD NOT BE USED WITHOUT WRITTEN PERMISSION
本図面は日本モレックス(株)の所有する情報を含むもので 当社の許可なく複製を禁止する。 MXJ-8