

20 19 18 17 16 15 14 13 12 11 10 9 8 7 6 5 4 3 2 1

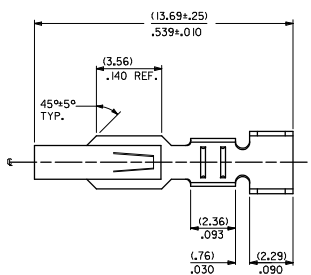
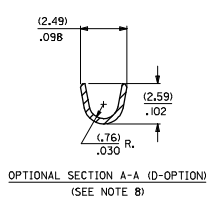
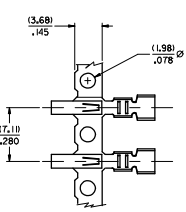

2478- * - * - *

MATERIAL CODE
L=27/.0106 THK
1=BRASS
3=PHOS BRONZE

OPTION CODE
BLANK-AS SHOWN
C=CAT EAR OPTION
D=OPTIONAL CONDUCTOR CRIMP (FOR IRELAND) (SEE OPT. SECTION A-A) WITHOUT CAT EARS
E=LOW INSERTION FORCE OPTION

WINDING SPEC.
A=PER ES-339-A
BLANK=PER ES-339-B
L=LOOSE

FINISH: PER SDES-88
(P909) *OVERALL HOT TIN DIP: 2.54 MICROMETERS MIN.
(550) SELECT GOLD: 0.38 MICROMETERS MIN.
OVERALL GOLD FLASH: 0.05 MICROMETERS MIN.
OVERALL NICKEL UNDERPLATE: 0.76 MICROMETERS MIN.
(555) SELECT GOLD: 0.38 MICROMETERS MIN.
OVERALL NICKEL UNDERPLATE: 0.76 MICROMETERS MIN.

*THE PRIMARY SHIPPING CARTON WILL BE LABELED 'COMPLIANT TO RoHS DIRECTIVE 2002/95/EC AND ELV ANNEX II OF DIRECTIVE 2000/53/EC'. CARTONS WITHOUT THIS LABEL MAY CONTAIN PRODUCT WITH TIN/LEAD PLATING.

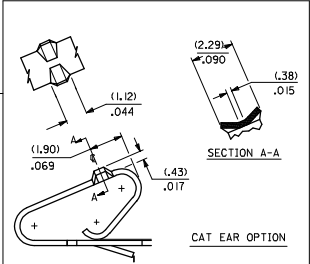
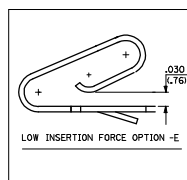
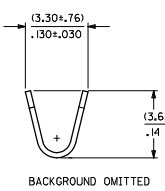
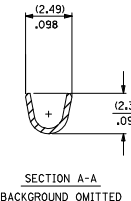
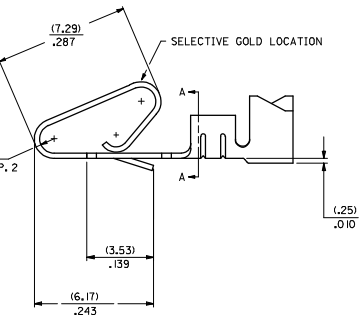
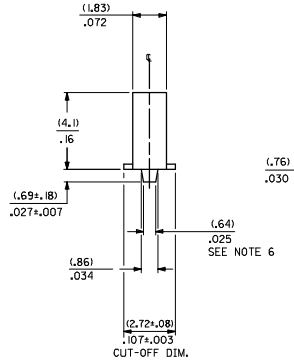

- NOTES:
- CRIMP ACCEPTS 18 TO 24 GA. WIRE WITH (2.79)/.110 MAX. INSUL. DIA. WHEN USED WITH 2574 CONNECTOR.
(2.54)/.100 MAX. INSUL. DIA. WHEN USED WITH 2139 CONNECTOR.
HOUSING 41695 IS RECOMMENDED FOR OVER (2.54)/.100 DIA. INSULATION.
CRIMP ACCEPTS (3.00)/.118 MAX. INSUL. DIA. WITH SPECIAL TOOLING.
 - DIMENSIONS GIVEN ACROSS CENTERLINES ARE SYMMETRICAL ABOUT THOSE CENTERLINES WITHIN HALF THE TOTAL TOLERANCE.
 -
 -
 -
 - (.86±.05)/.034±.002 IS AN OPTIONAL DESIGN.
 - THIS PART CONFORMS TO PRODUCT SPEC. 08-50.
 - CONDUCTOR CRIMP FOR 16 AWG. WIRE WITH .110 MAX. INSULATION DIA.

CHANGE TO MEO EIC NO. 11E2005-4602 W APPROVED BY: 2006/01/28 APPROVED BY: 2006/01/28	QUALITY SYMBOLS	GENERAL TOLERANCES (UNLESS SPECIFIED)	DIMENSION STYLE	SCALE	DESIGN UNITS	THIRD ANGLE PROJECTION	
	$\nabla=0$ $\nabla=0$	4 PLACES ±--- INCH 3 PLACES ±--- ±.010 2 PLACES ±.025 ±.014 1 PLACE ± 0.36 ±--- ANGULAR ±1/2°	IN/MM INCH	DRAWN BY: DATE SAMIEC 06/03/86 CHECKED BY: DATE PATEL 06/03/86 APPROVED BY: DATE LENZ 06/03/86	FILE CRIMP TERMINAL .156 CENTERS 18 TO 24 GA WIRE	MOLEX INCORPORATED	SHEET NO. 1 OF 2
	DRAFT WHERE APPLICABLE MUST REMAIN WITHIN DIMENSIONS	SEE CHART	MATERIAL NO. SD-2478	DOCUMENT NO. SD-2478			
	THIS DRAWING CONTAINS INFORMATION THAT IS PROPRIETARY TO MOLEX INCORPORATED AND SHOULD NOT BE USED WITHOUT WRITTEN PERMISSION						

h:\frame_d_p_ah.t Rev. D 2004/06/28 19 18 17 16 15 14 13 12 11 10 9 8 7 6 5 4 3 2 1

