

UNC #4-40 Hexscrew

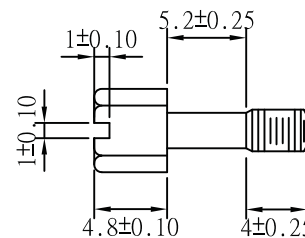

UNC #4-40 Hexnut

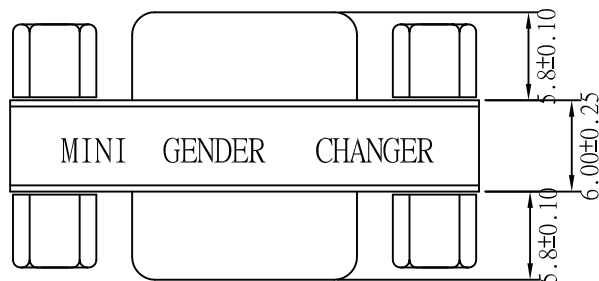
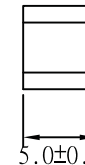

Pin Out

9P-Female

9P-Female

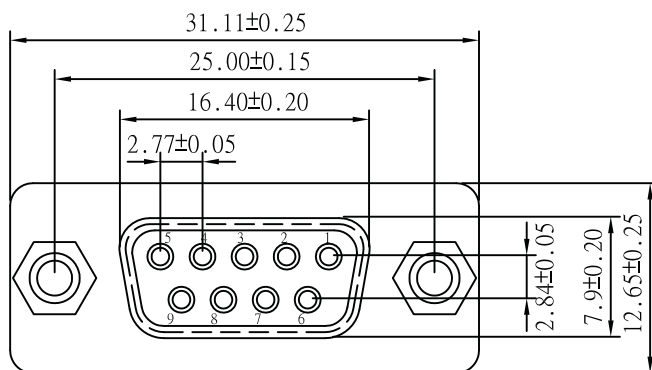
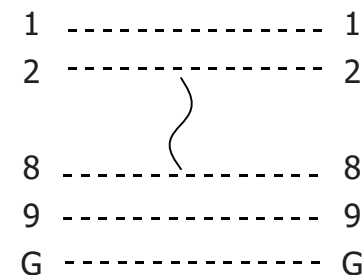

Material:

- Insulator: PBT Glass fibre reinforced UL 94 V0
- Contact: Brass
- Contact plating: Gold plated over nickel
- Shell: Tin plated shell
- Yellow label with black characters

Unit: MM



ITEM NO.

AB411-R

TITLE

Mini Gender Changer -
DSub 9Pin Female <=> DSub 9 Pin Female

ASSMANN
Electronics, Inc.

1840 W. Drake Drive, Suite 101 • Tempe, AZ 85283
Toll Free: 1-877-277-6266 • Email: info@usa-assmann.com

THIS DRAWING IS UNPUBLISHED
©Copyright 2011 by Assmann Electronic Components
All International Rights Reserved